

22260311	DATA SHEET	
Valid from: 21.12.2023	AB-C4-(L*)PUR-M8FA	

Product description

- Sensor/actuator cable, 4-pol, PUR halogen-free, black
- Angled M8-jack on free conductor end



General characteristics

Number of pins	4
Ambient temperature	-25 °C to +90 °C (-13°F to 194°F) (plug / jack) -40 °C to +80 °C (-40°F to 176°F) (cable, fixed installation) -25 °C to +80 °C (-13°F to 176°F) (cable, movable installation)
Degree of protection	IP65 / IP67 / IP68
Coding	A-standard
Tightening torque	0,2 Nm (M8-connector)
Plugging cycles	≥ 100

Variation

Article number	Description	Length [m]	Configuration
22260311	AB-C4-2,0PUR-M8FA	2	angled
22260149	AB-C4-3,0PUR-M8FA	3	angled
22260312	AB-C4-5,0PUR-M8FA	5	angled
22260319	AB-C4-10,0PUR-M8FA	10	angled

Additional note

Data sheet also valid for variant lengths. Other lengths on request.

Electrical properties

Rated voltage	60 V DC / 48 V AC
Rated current	4 A
Overvoltage category	II
Pollution degree	3

Mechanical properties

Jack

Inflammability class in accordance with UL 94	HB
Contact, material	CuSn
Contact carrier, material	TPU GF
Contact surface, material	Ni/Au
Knurl, material	Zinc diecasting, nickel-plated
Handle, material	TPU, flame retardant, self-extinguishing
Sealing, material	NBR

Line

Cable construction	4 x AWG24/32
Signal line, construction	32 x 0,1 mm
Conductor cross-section	0,25 mm ²
Conductor diameter including isolation	1,17 mm ± 0,02 mm

Creator: THLE3/PDP Released: IVSE1/PDP	Document: DB22260311EN Version: 06	Page 1 of 3
---	---------------------------------------	-------------

22260311	DATA SHEET	
Valid from: 21.12.2023	AB-C4-(L*)PUR-M8FA	

Cable outer diameter	4,4 mm ± 0,15mm
Insulation color	brown, white, blue, black
Sheath color	grey-black, RAL 7021
Number of bending cycles	10.000.000
Bending radius	44 mm
Traveling distance	10 m
Traveling speed	3 m/s
Acceleration	5 m/s ²
Cable weight	23 kg/km
Outer coating, material	PUR
Wire insulation, material	PP
Insulation resistance	≥ 100 GΩ*km (at 20 °C)
Conductor resistance	≤ 78 Ω/km (at 20 °C)
Flame resistance	acc. to UL 758 / 1581 FT2 DIN EN 60332-2-2 (20 s)
Halogen-free	acc. to DIN VDE 0472 Part 815
Oil resistance	acc. to DIN EN 60811-2-1
Other resistances	resistant to hydrolysis and microbes good resistant to acids, lyes and solvents limited UV resistance acc. to DIN EN ISO 4892-2-A

Standards/Approvals

Product standard, M8 connector	IEC 61076-2-104
UL-Listed, E-File	E249137

Technical drawing

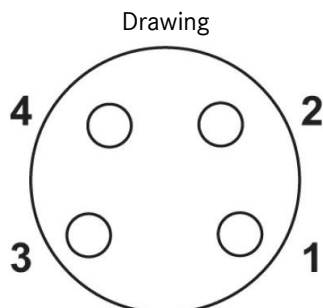
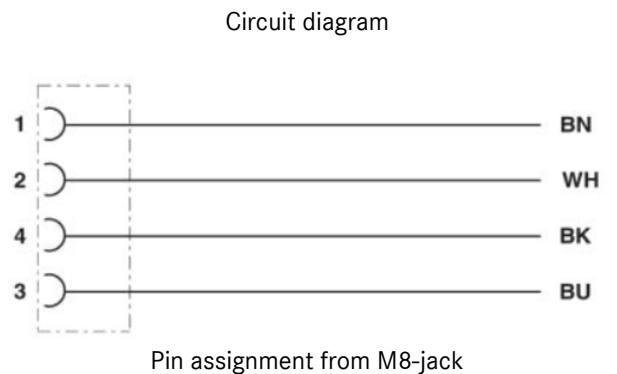
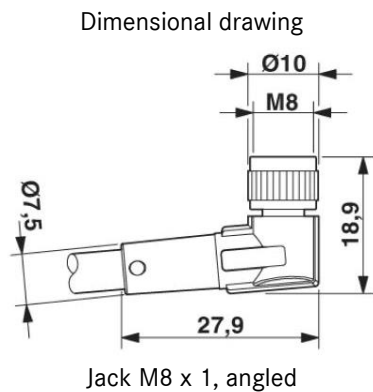

Pin assignment M8-jack, 4-pol, A-coding

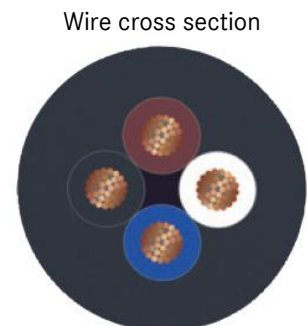

Creator: THLE3/PDP Released: IVSE1/PDP	Document: DB22260311EN Version: 06	Page 2 of 3
---	---------------------------------------	-------------

22260311	DATA SHEET	
Valid from: 21.12.2023	AB-C4-(L*)PUR-M8FA	

Application range

For increased mechanical load and rough operating conditions

Note

Photographs are not true to scale and do not represent detailed images of the respective products.

Creator: THLE3/PDP Released: IVSE1/PDP	Document: DB22260311EN Version: 06	Page 3 of 3
---	---------------------------------------	-------------