

**EPIC® SENSORS**

THREADED TEMPERATURE SENSOR WITHOUT NECK PIPE  
 TYPE T-B-ØK / W-B-ØK  
 DATA SHEET 1



## INSTALLATION INSTRUCTIONS AND USER MANUAL

### Table of contents

Product description and intended use.....	2
Temperatures, measuring.....	3
Temperatures, ambient.....	3
Temperatures, Ex versions.....	3
Code key.....	4
Technical data.....	5
Materials.....	5
Dimensional drawing.....	6
Installation instructions and example.....	7
Installation of accessories.....	8
Tightening torques.....	8
Opening the connection head, standard and Ex i versions.....	9
Opening the connection head, Ex d versions.....	10
Pt100; connection wiring.....	11
Pt100; measuring current.....	11
TC; connection wiring.....	12
TC; non-grounded or grounded types.....	12
TC; thermocouple cable standards (color table).....	13
Type label of standard versions.....	14
Serial number information.....	14
Ex d data (only for types with Ex d approval).....	15
Ex i data (only for types with Ex i approval).....	17
EU Declaration of Conformity.....	19
Manufacturer contact information.....	19
Document history.....	19
ANNEX A: Ex i specifications and special conditions for use	

## Product description and intended use

Sensor types T-B-ØK (thermocouple, TC) and W-B-ØK (resistance, RTD) are threaded temperature sensors without neck pipe, constructed according to DIN 43772 form 2.

Sensors are intended for various industrial measuring applications, to be immersed to process by the thread connection on the thermowell. The most common thread type is G1/2". Thermowell material can be chosen, and well length can be produced for a certain sensor element length, according to customer needs.

Threaded thermowells without neck pipe (cooling neck) are used when there is no insulation layer on the surface of installation thread. Next to thread located connection head - with transmitter and/or connection wires inside - does not tolerate very high temperatures.

Measuring elements are mineral insulated (MI) elements, which can be changed on the fly. Elements can be TC or RTD elements, standard versions are K-type thermocouple (for T-B-ØK) and 4-wire Pt100 (for W-B-ØK). Tailored versions are produced on request.

Sensors are available with ceramic connection block (type designation: "-CB") or with open wire ends to be connected to temperature transmitter inside the sensor head (type designation: "-TR"). The latter can be delivered with a transmitter.

Also available as ATEX and IECEx approved protection type Ex d and Ex i versions.  
Please see sections *Ex d data* and *Ex i data*.

EPIC® SENSORS temperature sensors are measuring devices intended for professional use. They should be mounted by professionally capable installer who understands the installations surroundings. The worker should understand mechanical and electrical needs and safety instructions of the object installation. Suitable safety gear for each installation task must be used.

## Temperatures, measuring

Allowed measuring temperature range for sensor tip is:

- With Pt100 -40...+250 °C
- With TC -40...+250 °C

## Temperatures, ambient

Allowed ambient temperature range for connection head, including connection wires, is:

- Without transmitter (element type -CB) -40...+135 °C
- With transmitter (element type -TR) according to transmitter manufacturers data

NOTE! This sensor type has no neck pipe for cooling purposes. The process connection thread is very close to the connection head.

Make sure the process temperature is not too much for the connection head and/or the transmitter inside.

## Temperatures, Ex versions

For Ex versions only (type designations -EXD- and -EXI-), specific temperature conditions apply according to the ATEX and IECEx certificates. For more details, please see sections:

- *Ex d data* (only for types with Ex d approval), sensor type designation -EXD-
- *Ex i data* (only for types with Ex i approval), sensor type designation -EXI-

## Code key

### Product code key

Example code: W — B — 9K — D/H — 160 — G½" — 4 — A — TR — X

W	= Pt100 resistance thermometer
2xW	= 2 x Pt100 resistance thermometer
T	= thermocouple
2xT	= 2 x thermocouple
B	= threaded sensor type (constant in code)
6, 9, 11	= thermowell outer diameter (ØOD) [mm], other diameters on request
K	= no cooling neck (constant in code)
B	= connection head B
D/H	= connection head with snap lock
D/H/D	= connection head with snap lock and double barrel (2x cable gland)
D/W/H	= high cover connection head with snap lock
D/W/H/D	= high cover connection head with snap lock and double barrel (2x cable gland)
EXD	= ATEX compatible connection head
HST	= acid proof connection head
N	= connection head N
160	= length, L [mm]
G½"	= thread size (all available, also NPT)
4,3,2	= Pt100 wire count
K,N,J	= thermocouple type
A,B	= Pt100 accuracy class, (class A as standard delivery)
1,2,3	= thermocouple accuracy class, (class 1 as standard delivery)
TR	= wires for transmitter connection
CB	= with ceramic terminal block
EXI	= Ex i certified sensor
X	= additional details on the text line

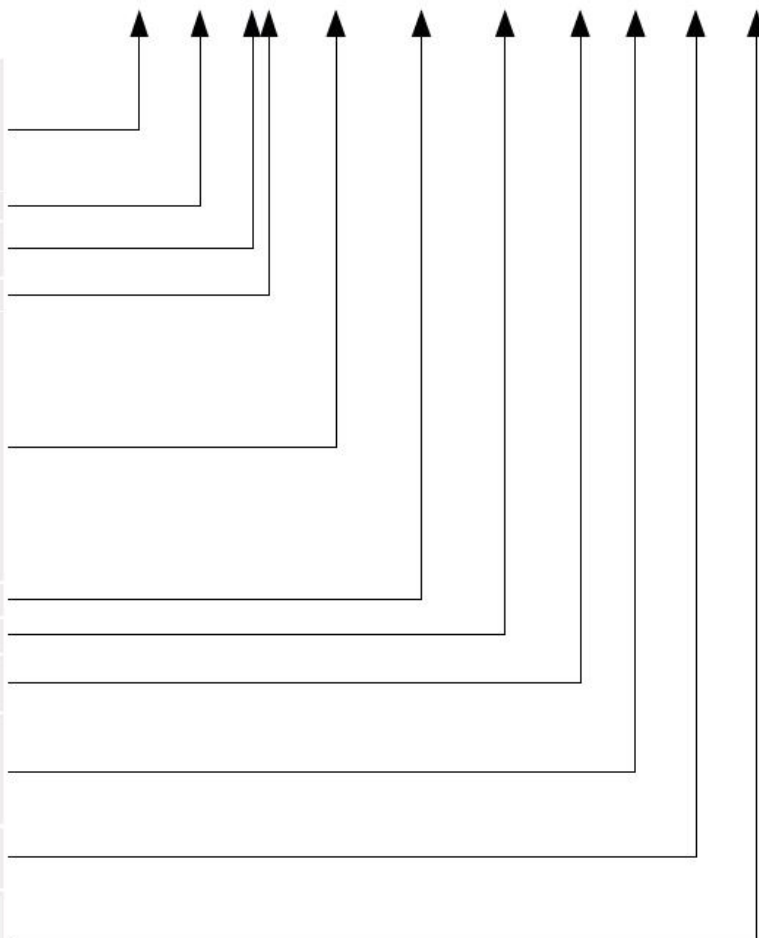

## Technical data

<b>Materials</b>	AISI 316L, maximum temperature +250 °C, temporarily +300 °C, other materials on request
<b>Thread</b>	G, R, metric and NPT threads as standard delivery, other threads on request
<b>Tolerances Pt 100 (IEC 60751)</b>	A tolerance $\pm 0.15 + 0.002 \times t$ , operating temperature -100...+450 °C B tolerance $\pm 0.3 + 0.005 \times t$ , operating temperature -196...+600 °C B 1/3 DIN, tolerance $\pm 1/3 \times (0.3 + 0.005 \times t)$ , operating temperature -196...+600 °C B 1/10 DIN, tolerance $\pm 1/10 \times (0.3 + 0.005 \times t)$ , operating temperature -196...+600 °C
<b>Tolerances thermocouple (IEC 60584)</b>	Type J tolerance class 1 = -40...375 °C $\pm 1.5$ °C, 375...750 °C $\pm 0.004 \times t$ Type K and N tolerance class 1 = -40...375 °C $\pm 1.5$ °C, 375...1000 °C $\pm 0.004 \times t$
<b>Temperature range Pt100</b>	-40...+250 °C
<b>Temperature range thermocouple</b>	-40...+250 °C
<b>Approvals</b>	ATEX, IECEx, EAC Ex, EAC EMC, METROLOGICAL PATTERN APPROVAL
<b>Quality certificate</b>	ISO 9001:2015 and ISO 14001:2015 issued by DNV
<b>IP rating</b>	IP65, higher IP rating on request

## Materials

These are the standard materials of components for the sensor types T-B-ØK / W-B-ØK.

- Connection head:
  - Standard or Ex i Aluminum
  - Ex d (type designation EXD) Aluminum or Stainless Steel (DIN 1.4401, AISI 316)
- Gasket of the connection head cover Silicone
- Sensor element / MI cable sheath for Pt100: AISI 316L,  
for TC: Inconel 600 or AISI 316L (depending on TC type)
- Connection thread AISI 316L
- Gasket for the process thread Copper
- Thermowell AISI 316L

Other materials can be used on request.

Dimensional drawing

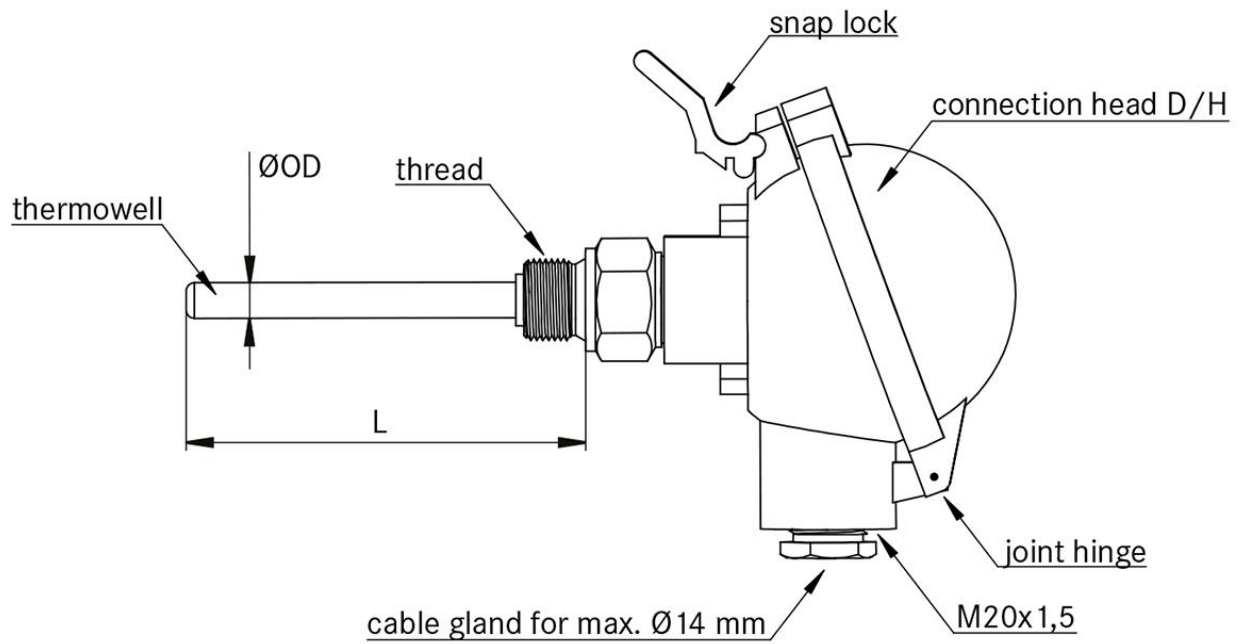

## Installation instructions and example

Before any installation, make sure the target process/machinery and site are safe to work!

Make sure the process thread matches the thread of the sensor to be installed.

Installation phases:

- Make sure the gasket (sealing ring) is on its place before screwing the sensor to process thread. Sealing ring material must be chosen according to the temperature and chemical circumstances of the process. The standard material is copper. Note! With R and NPT thread there is no sealing ring.
- Screw in the sensor to the process thread. Make sure the sealing ring is securely attached between the face surfaces of sensor and process threads.
- To tighten the thread connection, use necessary force only. Excess force may destroy the sealing ring. Allowed maximum tightening forces are given on applicable standards for each thread size and sealing material.

Image below: this example shows a sensor installed on a welded threaded sleeve on process piping.

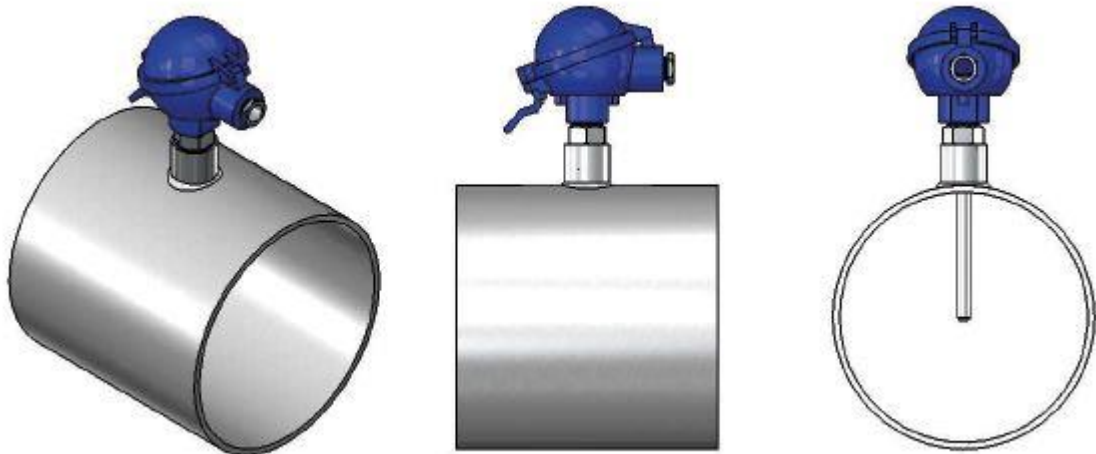

## Installation of accessories

As accessories there are welded threaded sleeves available, for occasions where the thread is not readily available.

The sleeve material must be chosen according to the process media and structure material to be welded on.

Before any installation, make sure the target process/machinery and site are safe to work!

Also, make sure there are no obstacles to welding work.

Installation phases:

- First drill a hole large enough for the lower end of the sleeve to enter.
- Weld the sleeve securely to the process material.
- After cooling, finalizing the welding process and getting approved by inspectors (if needed), finally install the sensor to the welded thread, as presented on page *Installation instructions*.



## Tightening torques

Use only tightening torques allowed in applicable standards of each thread size and material.



## Opening the connection head, standard and Ex i versions

Before any connection work the connection head has to be opened.

Do not open the connection head cover if there is a risk of dirt or moisture/liquids entering the wiring space inside!

Image below: Opening the cover, when using a connection head...

1. with snap lock (quick release clip), connection head type designation -D/H-; lift the clip up.
2. with screw lock; open the screw by twisting it counter-clockwise.

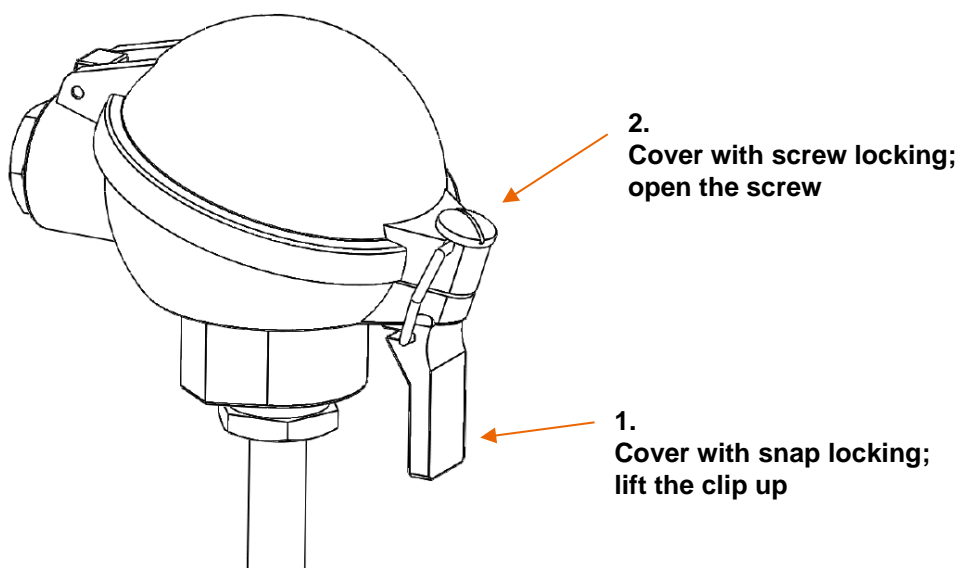

After releasing the locking, lift the cover up.

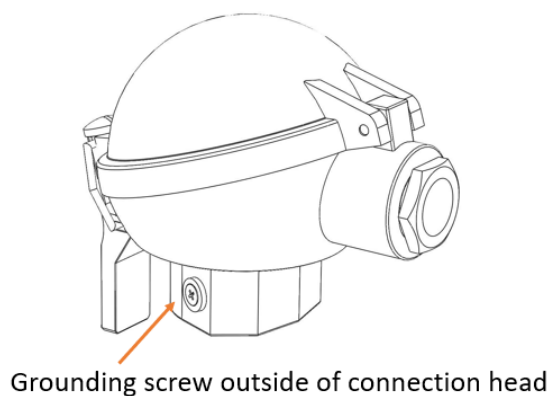
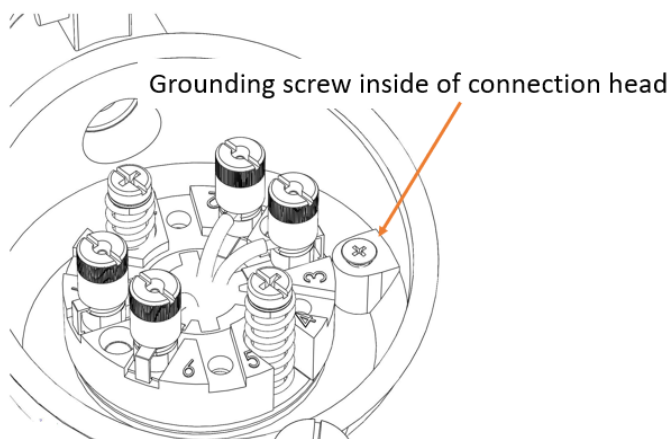



## Pt100; connection wiring

Image below: These are the connection colors of Pt100 resistor connections, according to standard EN 60751.

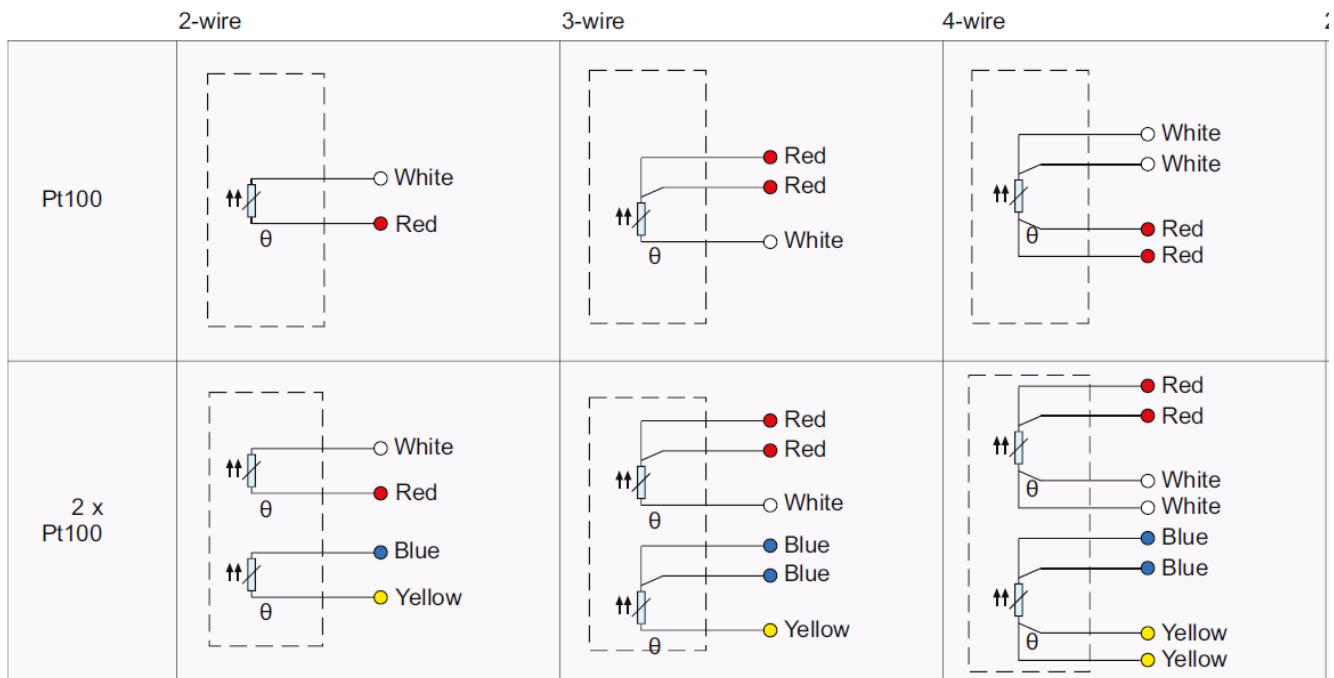

Other connections on request.

## Pt100; measuring current

The highest allowed measuring current for Pt100 measuring resistors depends on resistor type and brand.

Normally the recommended maximum values are:

- Pt100            1 mA
- Pt500            0,5 mA
- Pt1000          0,3 mA.

Do not use higher measuring current. It will lead to false measurement values and might even destroy the resistor.

Above listed values are normal measuring current values. For Ex i certified sensor types, type designation -EXI-, higher values (worst case) are used for the self-heating calculation for safety reasons. For further details and calculation examples, please see ANNEX A.

## TC; connection wiring

Image below: These are the connection colors of TC types J, K and N.

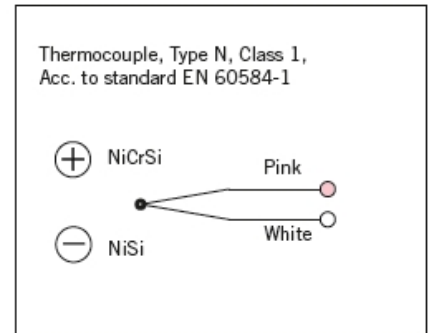
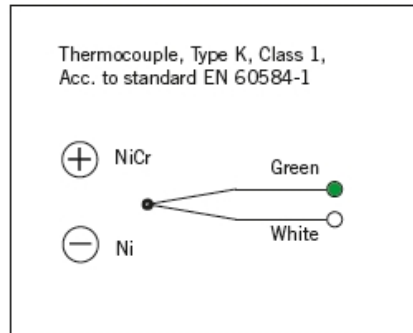
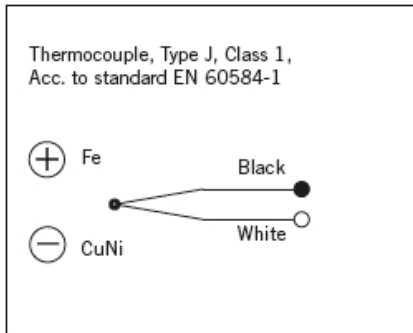

Other types on request.

## TC; non-grounded or grounded types

Normally the thermocouple sensors are non-grounded, which means the MI cable sheath is not connected to the thermo material hot junction, where two materials are welded together.

In special applications also grounded types are used.

NOTE! Non-grounded and grounded sensors cannot be connected to same circuits, make sure you are using the right type.

NOTE! Grounded TCs are not allowed for Ex i certified sensor types.

Image below: Non-grounded and grounded structures in comparison.

### Non-grounded TC

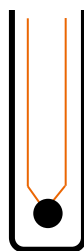





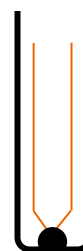















Thermo material hot junction and MI cable sheath are galvanically isolated from each other.

### Grounded TC



Thermo material hot junction has galvanic connection with MI cable sheath.

TC; thermocouple cable standards (color table)

New standards:	IEC 60584-3	DIN EN 60584	ISA MC 96.1
Thermo Type	IEC 584	DIN 43714	ANSI MC 96.1
NiCr-Ni / K KCA: Fe-CuNi	 + green/ - white Jacket: green	 + red/ - green Jacket: green	 + yellow/ - red Jacket: yellow
Fe-CuNi / L		 + red/ - blue Jacket: blue	
Fe-CuNi / J	 + black/ - white Jacket: black		 + white/ - red Jacket: black
Pt10Rh-Pt / S SCA: E-Cu/A-Cu	 + orange/ - white Jacket: orange	 + red/ - white Jacket: white	 + black/ - red Jacket: green
Pt13Rh-Pt / R RCA: E-Cu/A-Cu	 + orange/ - white Jacket: orange	 + red/ - white Jacket: white	 + black/ - red Jacket: green
Pt30Rh-Pt6Rh / B BC: S-Cu/E-Cu	 + grey/ - white Jacket: grey		 + grey/ - red Jacket: grey
NiCrosil-Nisil / N NC: Cu-CuNi	 + pink/ - white Jacket: pink		
Cu-CuNi / U		 + red/ - brown Jacket: brown	
Cu-CuNi / T	 + brown/ - white Jacket: brown		
NiCr-CuNi / E	 + purple/ - white Jacket: purple	 + red/ - purple Jacket: purple	 + purple/ - red Jacket: purple

## Type label of standard versions

Each sensor has a type label attached to it. It is a moisture and wear proof industrial grade sticker, with black text on white label. This label has printed information of trade name, web page, type code, CE-mark, product number and serial number, including production date. For these sensors manufacturer contact information is printed on a separate label.

Image below: Example of a non-Ex sensor type label.

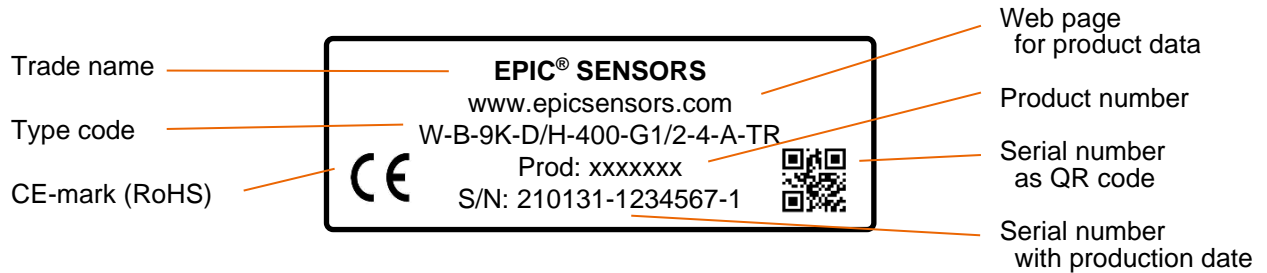

For EAC EMC-approved, sensor+transmitter combination versions, exported to Eurasian Customs Union area, there is a special type label.

Image below: Example of an EAC EMC-approved product type label, including sensor (1) and transmitter (2).



## Serial number information

Serial number S/N is always printed on type label in the following form: yymmdd-xxxxxx-x:

- yymmdd            production date, e.g. “210131” = 31.1.2021
- -xxxxxx         production order, e.g. “1234567”
- -x                sequential ID number within this production order, e.g. “1”

## Ex d data (only for types with Ex d approval)

This sensor type is available also with ATEX, IECEx and EAC Ex d approvals. Assembly consists of a temperature sensor connected to a transmitter or ceramic terminal block in an Ex db certified enclosure (sensor head type designation -EXD-). All relevant Ex data is given below.

### Ex d – Special Conditions for Use

For Ex d versions only (type designation -EXD-), specific conditions apply according to the ATEX and IECEx certificates:

Allowed ambient temperature range for the connection head without enclosure window:

-40 °C to + 60 °C with temperature class T6/T80 °C

-40 °C to + 75 °C with temperature class T5/T95 °C

Allowed ambient temperature range for the connection head with enclosure window:

-40 °C to + 60 °C with temperature class T6/T80 °C.

### Ex d certificates and Ex markings

Certificate - Number	Issued by	Applicable area	Marking
<b>ATEX –</b> EESF 18 ATEX 052X	Eurofins Expert Services Oy, Finland, Notified Body Nr 0537	Europe	Ex II 2G Ex db IIC T6/T5 Gb Ex II 2D Ex tb IIIC T80°C/T95°C Db
<b>IECEx –</b> IECEx EESF 20.0034X	Eurofins Expert Services Oy, Finland, Notified Body Nr 0537	Global	Ex db IIC T6/T5 Gb Ex tb IIIC T80°C/T95 °C Db
<b>EAC -</b> № EAЭC RU C- FI.AA71.B.00130-19	Lenpromexpertiza OOO, Russia	Eurasian Customs Union (Belarus, Kazakhstan, Russia)	1 Ex d IIC T6/T5 Gb X Ex tb IIIC T80°C/T95°C Db X

## Ex d type label

For ATEX, IECEx and KCs Ex d approved versions there is more information on the label, according to applicable standards.

Image below: Example of an ATEX and IECEx approved sensor type label.

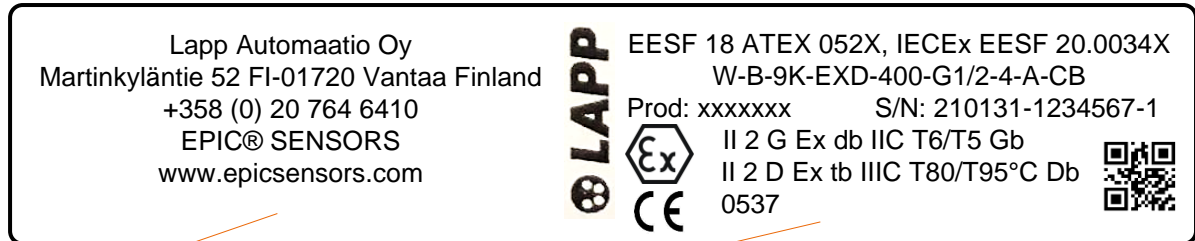

Manufacturer contact information. For some sensor types, this may also be printed on a separate label for practical reasons.

Ex certificate number(s)  
 Type code  
 Product number Serial number with production date  
 Ex-mark (ATEX) Ex markings  
 CE-mark (ATEX and RoHS) Serial number as QR code  
 Notified body number  
 Special technical values (if needed)

For EAC Ex d approved sensor versions, exported to Eurasian Customs Union area, there is a special type label.

Image below: Example of an EAC Ex-approved sensor type label.

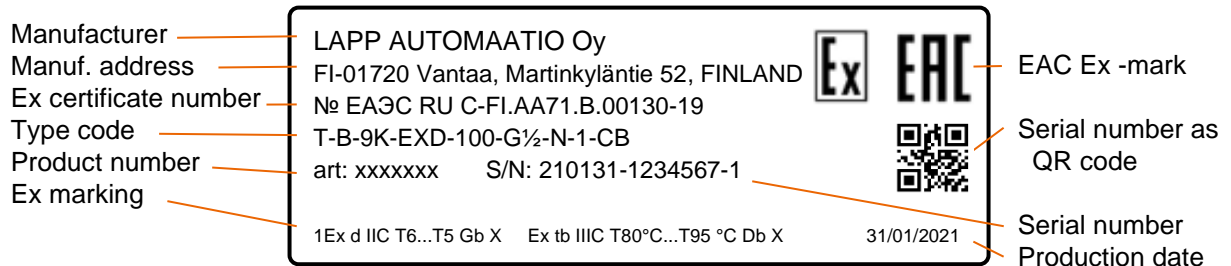



## Ex i data (only for types with Ex i approval)

This sensor type is available also with ATEX and IECEx Ex i approvals. Assembly consists of a temperature sensor connected to a transmitter or ceramic terminal block in an enclosure (sensor type designation -EXI-). All relevant Ex data is given below.

## Ex i – Special Conditions for Use

There are special specifications and conditions for use defined in certificates. These include e.g. Ex data, allowed ambient temperatures, and self-heating calculation with examples. These are presented in **Annex A: Specification and special conditions for use - Ex i approved EPIC®SENSORS temperature sensors.**

## Ex i certificates and Ex markings

Certificate - Number	Issued by	Applicable area	Marking
<b>ATEX –</b> EESF 21 ATEX 043X	Eurofins Electric & Electronics Finland Oy, Finland, Notified Body Nr 0537	Europe	Ex II 1G Ex ia IIC T6...T3 Ga Ex II 1/2G Ex ib IIC T6...T3 Ga/Gb Ex II 1D Ex ia IIIC T135 °C Da Ex II 1/2D Ex ib IIIC T135 °C Da/Db
<b>IECEx –</b> IECEx EESF 21.0027X	Eurofins Electric & Electronics Finland Oy, Finland, Notified Body Nr 0537	Global	Ex ia IIC T6...T3 Ga Ex ib IIC T6...T3 Ga/Gb Ex ia IIIC T135 °C Da Ex ib IIIC T135 °C Da/Db

Note! Name change of the Notified Body Nr 0537:

- Until 31.3.2022, the name was: Eurofins Expert Services Oy
- As of 1.4.2022, the name is: Eurofins Electric & Electronics Finland Oy.

## Ex i type label

For ATEX and IECEx Ex i approved versions there is more information on the label, according to applicable standards.

Image below: Example of an ATEX and IECEx Ex i approved sensor type label.

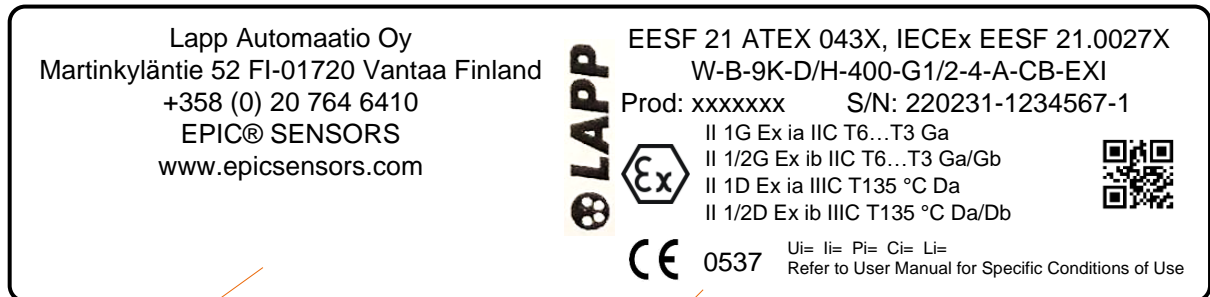

Manufacturer contact information.  
 For some sensor types, this may also be printed on a separate label for practical reasons.

Ex certificate number(s)  
 Type code  
 Product number      Serial number with production date  
 Ex-mark (ATEX)      Ex markings  
 CE-mark (ATEX and RoHS)      Serial number as QR code  
 Notified body number  
 Special technical values (if needed)

## EU Declaration of Conformity

The EU Declaration of Conformity, declaring products' conformance to the European Directives, is delivered with products or sent on request.

## Manufacturer contact information

### Manufacturer HQ main office:

**Lapp Automaatio Oy**  
Street address Martinkyläntie 52  
Postal address FI-01720 Vantaa, Finland

### Production site and logistics:

**Lapp Automaatio Oy**  
Street address Varastokatu 10  
Postal address FI-05800 Hyvinkää, Finland

Phone (sales) +358 20 764 6410

Email [epicsensors.fi.lav@lapp.com](mailto:epicsensors.fi.lav@lapp.com)  
Https [www.epicsensors.com](http://www.epicsensors.com)

## Document history

Version / date	Author(s)	Description
20230707	LAPP/VeTe	Ex i and Ex d ground connection and some corrections for the text.
20220822	LAPP/JuPi	Telephone number update
20220401	LAPP/JuPi	Original version

Although every reasonable effort is made to ensure the accuracy of the content of the operating instructions, Lapp Automaatio Oy is not responsible for the way the publications are used or for possible misinterpretations by end users. The user must ensure that she or he has the latest edition of this publication.

We reserve the right to make changes without prior notice. © Lapp Automaatio Oy

## ANNEX A - Specification and special conditions for use - Ex i approved EPIC® SENSORS temperature sensors

Annex A, page 1/4

### Ex data for RTD (resistance temperature sensor) and TC (Thermocouple temperature sensor)

Sensor Ex data, maximum interface values, without transmitter or / and display.

Electrical values	For Group IIC	For Group IIIC
Voltage $U_i$	30 V	30 V
Current $I_i$	100 mA	100 mA
Power $P_i$	750 mW	550 mW @ $T_a +100\text{ °C}$
		650 mW @ $T_a +70\text{ °C}$
		750 mW @ $T_a +40\text{ °C}$
Capacitance $C_i$	Negligible, *	Negligible, *
Inductance $L_i$	Negligible, *	Negligible, *

Table 1. Sensor Ex data.

\* For sensors with long cable part, the parameters  $C_i$  and  $L_i$  must be included in the calculation.  
Following values per meter can be used according to EN 60079-14:  
 $C_{\text{cable}} = 200\text{ pF/m}$  and  $L_{\text{cable}} = 1\text{ μH/m}$ .

### Allowed ambient temperatures - Ex i temperature class, without transmitter and/or display.

Marking, Gas Group IIC	Temperature class	Ambient temperature
II 1G Ex ia IIC T6 Ga II 1/2G Ex ib IIC T6-T3 Ga/Gb	T6	-40...+80 °C
II 1G Ex ia IIC T5 Ga II 1/2G Ex ib IIC T6-T3 Ga/Gb	T5	-40...+95 °C
II 1G Ex ia IIC T4-T3 Ga II 1/2G Ex ib IIC T6-T3 Ga/Gb	T4-T3	-40...+100 °C
Marking, Dust Group IIIC	Power $P_i$	Ambient temperature
II 1D Ex ia IIIC T135 °C Da II 1/2D Ex ib IIIC T135 °C Da/Db	750 mW	-40...+40 °C
II 1D Ex ia IIIC T135 °C Da II 1/2D Ex ib IIIC T135 °C Da/Db	650 mW	-40...+70 °C
II 1D Ex ia IIIC T135 °C Da II 1/2D Ex ib IIIC T135 °C Da/Db	550 mW	-40...+100 °C

Table 2. Ex i temperature classes and allowed ambient temperature ranges

#### Note!

The temperatures above are without cable glands.

The compatibility of cable glands must be according to the application specifications.

If the transmitter and/or display will be inside the transmitter housing, the specific Ex requirements of the transmitter and/or display installation must be noted.

The used materials must comply the needs of application, e.g., abrasion, and the temperatures above.

For EPL Ga Group IIC the aluminium parts in connection heads are subject to sparking by impacts or friction.

For Group IIIC the maximum input power  $P_i$  shall be observed.

When the sensors are mounted across boundary between different Zones, refer to standard IEC 60079-26 section 6, for ensuring the boundary wall between different hazardous areas.

## ANNEX A - Specification and special conditions for use - Ex i approved EPIC® SENSORS temperature sensors

Annex A, page 2/4

### Considering sensor self-heating

Self-heating of the sensor tip shall be considered in respect with Temperature Classification and associated ambient temperature range and manufacturer's instructions for calculating tip surface temperature according to thermal resistances stated in the instructions shall be observed.

Allowed ambient temperature range of sensor head or process connection for Groups IIC and IIIC with different temperature classes are listed in Table 2. For Group IIIC the maximum input power  $P_i$  shall be observed.

The process temperature shall not adversely affect ambient temperature range assigned for Temperature Classification.

### Calculation for self-heating of the sensor at the tip of sensor or the thermowell tip

When the sensor-tip is located at environment where the temperature is within  $T_6...T_3$ , it is needed to consider the self-heating of the sensor. Self-heating is of particular significance when measuring low temperatures.

The self-heating at the sensor tip or thermowell tip depends on the sensor type (RTD/TC), the diameter of sensor and structure of sensor. It is also needed to consider the Ex i values for the transmitter. The table 3. shows the  $R_{th}$  values for different type of sensors structure.

Sensor type	Thermal resistance $R_{th}$ [°C / W]					
	Resistance thermometer (RTD)			Thermocouple (TC)		
Measuring insert diameter	< 3 mm	3...<6 mm	6...8 mm	< 3 mm	3...<6 mm	6...8 mm
Without thermowell	350	250	100	100	25	10
With thermowell made from tube material (e.g. B-6k, B-9K, B-6, B-9, A-15, A-22, F-11, etc)	185	140	55	50	13	5
With thermowell – solid material (e.g. D-Dx, A-Ø-U)	65	50	20	20	5	1

Table 3. Thermal resistance based on Test report 211126

#### Note!

If the measuring device for RTD-measuring is using measuring current  $> 1$  mA, the maximum surface temperature of the temperature sensor tip should be calculated and taken to account. Please see next page.

If sensor type has multiple sensing elements included, and those are used simultaneously, note that the maximum power for all sensing elements should not be more than the allowed total power  $P_i$ . Maximum power must be limited to 750 mW. This must be guaranteed by process owner. (Not applicable for Multi-point temperature sensor types T-MP / W-MP or T-MPT / W-MPT with segregated Exi circuits).

## ANNEX A - Specification and special conditions for use - Ex i approved EPIC® SENSORS temperature sensors

Annex A, page 3/4

### Calculation for maximum temperature:

The self-heating of the sensor tip can be calculated from formula:

$$T_{max} = P_o \times R_{th} + MT$$

- (T<sub>max</sub>) = Maximum temperature = surface temperature at the sensor tip
- (P<sub>o</sub>) = Maximum feeding power for the sensor (see the transmitter certificate)
- (R<sub>th</sub>) = Thermal resistance (K/W, Table 3.)
- (MT) = Medium temperature.

### Calculate the maximum possible temperature at the tip of sensor:

#### Example 1 - Calculation for RTD-sensor tip with thermowell

Sensor used at Zone 0

RTD sensor type: W-M-9K . . . (RTD-sensor with head-mounted transmitter).

Sensor with thermowell, diameter of Ø 9 mm.

Medium temperature (MT) is 120 °C

Measuring is made with PR electronics head mounted transmitter 5437D and isolated barrier PR 9106 B.

Maximum temperature (T<sub>max</sub>) can be calculated by adding the temperature of the medium that you are measuring and the self-heating. The self-heating of the sensor tip can be calculated from the Maximum power (P<sub>o</sub>) which is feeding the sensor and R<sub>th</sub>-value of used sensor type. (See the Table 3.)

Supplied power by PR 5437 D is (P<sub>o</sub>) = 23,3 mW (from the transmitter Ex-certificate)

Temperature class T4 (135 °C) must not be exceeded.

Thermal resistance (R<sub>th</sub>) for the sensor is = 55 K/W (from Table 3).

Self-heating is 0.0233 W \* 55 K/W = 1,28 K

Maximum temperature (T<sub>max</sub>) is MT + self-heating: 120 °C + 1,28 °C = 121,28 °C

The result in this example shows that, the self-heating at the sensor tip is negligible.

The safety margin for (T<sub>6</sub> to T<sub>3</sub>) is 5 °C and that must be subtracted from 135 °C; means that up to 130 °C would be acceptable. In this example the temperature of class T4 is not exceeded.

#### Example 2 - Calculation for RTD-sensor tip without the thermowell (RTD).

Sensor used at Zone 1

RTD sensor type: W-M-6/303 . . . (RTD-sensor with cable, without head-mounted transmitter)

Sensor without thermowell, diameter of Ø 6 mm.

Medium temperature (MT) is 40 °C

Measuring is made with rail-mounted PR electronics PR 9113D isolated transmitter/barrier.

Maximum temperature (T<sub>max</sub>) can be calculated by adding the temperature of the medium that you are measuring and the self-heating. The self-heating of the sensor tip can be calculated from the Maximum power (P<sub>o</sub>) which is feeding the sensor and R<sub>th</sub>-value of used sensor type. (See the Table 3.)

Supplied power by PR 9113D is (P<sub>o</sub>) = 40,0 mW (from the transmitter Ex-certificate)

Temperature class T3 (200 °C) must not be exceeded.

Thermal resistance (R<sub>th</sub>) for the sensor is = 100 K/W (from Table 3).

Self-heating is 0.040 W \* 100 K/W = 4,00 K

Maximum temperature (T<sub>max</sub>) is MT + self-heating: 40 °C + 4,00 °C = 44,00 °C

The result in this example shows that, the self-heating at the sensor tip is negligible.

The safety margin for (T<sub>6</sub> to T<sub>3</sub>) is 5 °C and that must be subtracted from 200 °C; means that up to 195 °C would be acceptable. In this example the temperature of class T3 is not exceeded.

**ANNEX A - Specification and special conditions for use**  
**- Ex i approved EPIC® SENSORS temperature sensors**

Annex A, page 4/4

**Additional information for Group II devices:** (acc. to EN IEC 60079-0: 2019 section: 5.3.2.2 and 26.5.1)

Temperature class for T3 = 200 °C

Temperature class for T4 = 135 °C

Safety margin for T3 to T6 = 5 K

Safety margin for T1 to T2 = 10 K.

**Note!**

This ANNEX is an instructional document on specifications.  
For original regulatory data on specific conditions, always refer to ATEX and IECEx certificates:

**EESF 21 ATEX 043X**  
**IECEX EESF 21.0027X**