

EPIC® SENSORS

TEMPERATURE SENSOR WITH CABLE
TYPE T-CABLE / W-CABLE, WT-KAAPELI-...-EX
DATA SHEET 16

INSTALLATION INSTRUCTIONS AND USER MANUAL



Table of contents

Product description and intended use.....	2
Temperatures, measuring.....	3
Temperatures, ambient.....	3
Temperatures, Ex i versions.....	3
Temperatures, Ex e versions.....	4
Code key.....	5
Dimensional drawing.....	5
Technical data.....	6
Materials.....	6
Installation instructions and example.....	7
Tightening torques.....	7
Installation of accessories.....	8
Pipe fittings = pipe clamps:.....	8
Pt100; connection wiring.....	9
Pt100; measuring current.....	9
TC; connection wiring.....	10
TC; non-grounded or grounded types.....	10
TC; thermocouple cable standards (color table).....	11
Type label of standard versions.....	12
Serial number information.....	12
Ex e data (only for types with Ex e approval).....	13
Ex i data (only for types with Ex i approval).....	15
EU Declaration of Conformity.....	17
Manufacturer contact information.....	17
Document history.....	17
ANNEX A: Ex i specifications and special conditions for use	

Product description and intended use

Sensor types T-CABLE (thermocouple, TC) and W-CABLE (resistance, RTD) are temperature sensors with cable.

Sensors are intended for various industrial measuring applications. The construction allows very versatile use cases. Sensor element protection tube material can be chosen, and element / cable length can be produced according to customer needs.

Measuring elements are rigid, non-bendable versions. Elements can be TC or RTD elements, standard versions are K-type thermocouple (for T-CABLE) and 4-wire Pt100 (for W-CABLE). Tailored versions are produced on request.

Wire and cable sheath materials can be chosen.

Also available as special versions for Ex applications:

- Ex e: Also available as ATEX-approved protection type Ex e cable sensor versions. Please see section *Ex e data*.
- Ex i: Also available as ATEX and IECEx approved protection type Ex i versions. Please see section *Ex i data*.

EPIC® SENSORS temperature sensors are measuring devices intended for professional use. They should be mounted by professionally capable installer who understands the installations surroundings. The worker should understand mechanical and electrical needs and safety instructions of the object installation. Suitable safety gear for each installation task must be used.

Temperatures, measuring

Allowed measuring temperature range for sensor tip is:

- With Pt100 -200...+350 °C, depending on cable material
- With TC -200...+350 °C, depending on TC type and cable material

Versions for higher temperatures on request.

Temperatures, ambient

Allowed maximum ambient temperature for wires or cable, according to cable type, is:

- SIL = silicone, max. +180 °C
- FEP = fluoropolymer, max. +205 °C
- GGD = glass silk cable/metal braid jacket, max. +350 °C
- FDF = FEP wire insulation/braid shield/FEP jacket, max. +205 °C
- SDS = silicone wire insulation/braid shield/silicone jacket, only available as 2 wire cable, max. +180 °C
- TDT = fluoropolymer wire insulation/braid shield/ fluoropolymer jacket, max. +205 °C
- FDS = FEP wire insulation/braid shield/silicone jacket, max. +180 °C
- FS = FEP wire insulation/silicone jacket, max. +180 °C

Make sure the process temperature is not too much for the cable.

Temperatures, Ex i versions

For Ex i versions only (type designations -EXI-), specific temperature conditions apply according to the ATEX and IECEx certificates. For more details, please see section: *Ex i data* (only for types with Ex i approval).

Temperatures, Ex e versions

The Ex e approved RTD cable sensor type is **WT-KAAPELI-...-EX**. It is a rigid, non-bendable sensor structure, similar to standard version W-CABLE.

For Ex e cable sensor versions only, specific conditions apply according to the ATEX certificates.

For type WT-KAAPELI-...-EX, certificate number EESF 18 ATEX 053X Issue 1:

The process temperature shall not exceed allowed maximum ambient temperature limits for Groups IIC and IIIC.

Allowed maximum ambient temperature ranges for Group IIC according to T Class ranges T6...T3 are:

T6: $-40\text{ °C} \leq T_{amb} \leq +80\text{ °C}$
T5: $-40\text{ °C} \leq T_{amb} \leq +95\text{ °C}$
T4: $-40\text{ °C} \leq T_{amb} \leq +130\text{ °C}$
T3: $-40\text{ °C} \leq T_{amb} \leq +185\text{ °C}$

Allowed maximum ambient temperature ranges for Group IIIC according to T Class ranges T60 °C...T200 °C are:

T60 °C: $-40\text{ °C} \leq T_{amb} \leq +60\text{ °C}$
T200 °C: $-40\text{ °C} \leq T_{amb} \leq +200\text{ °C}$

For intermediate values, the maximum surface temperature $T^{**}\text{ °C}$ shall be equal to maximum T_{amb} value.

Please see also section *Ex e data*.

Code key

Example code: W — CABLE — 6 / 100 — 5000 / SIL — 4 — A — X

W	= Pt100 resistance thermometer
2xW	= 2 x Pt100 resistance thermometer
T	= thermocouple
2xT	= 2 x thermocouple
CABLE	= cable sensor (constant in code)
3, 4, 5, 6, 8	= outer diameter of sensor element (ØOD) [mm] (other diameters on request)
100	= sensor element length, L [mm]
5000	= cable length, CL [mm]
SIL, FEP, GGD, FDF, TDT, SDS, FDS, FS	= cable material (for more information, look technical data on first page of the datasheet)
4,3,2 K,N,J	= Pt100 wire count = thermocouple type
A,B	= Pt100 accuracy class, (class A as standard delivery)
1,2,3	= thermocouple accuracy class, (class 1 as standard delivery)
EX	= Ex e certified sensor
EXI	= Ex i certified sensor
X	= additional details on the text line

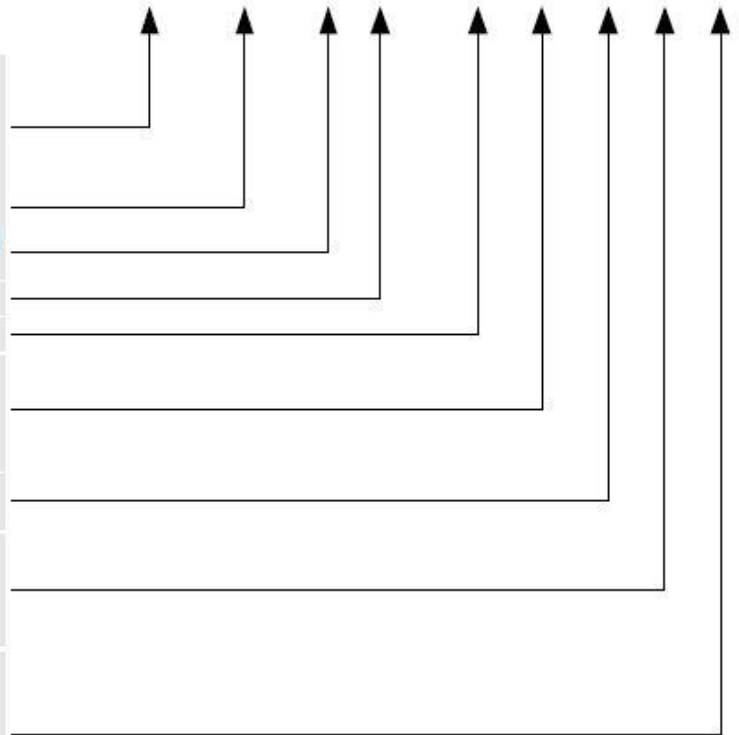

Dimensional drawing

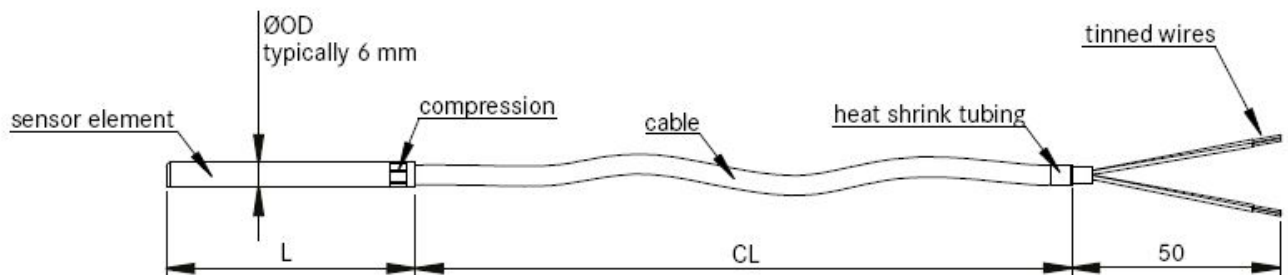

Technical data

Materials	AISI 316L, maximum temperature +300 °C, temporarily +350 °C, other materials on request
Diameter	3, 4, 5, 6, 8 mm, other diameters on request
Cable materials	SIL = silicone, max. +180 °C FEP = fluoropolymer, max. +205 °C GGD = glass silk cable/metal braid jacket, max. +350 °C FDF = FEP wire insulation/braid shield/FEP jacket, max. +205 °C SDS = silicone wire insulation/braid shield/silicone jacket, only available as 2 wire cable, max. +180 °C TDT = fluoropolymer wire insulation/braid shield/fluoropolymer jacket, max. +205 °C FDS = FEP wire insulation/braid shield/silicone jacket, max. +180 °C FS = FEP wire insulation/silicone jacket, max. +180 °C
Tolerances Pt100 (IEC 60751)	A tolerance $\pm 0.15 + 0.002 \times t$, operating temperature -100...+450 °C B tolerance $\pm 0.3 + 0.005 \times t$, operating temperature -196...+600 °C B 1/3 DIN, tolerance $\pm 1/3 \times (0.3 + 0.005 \times t)$, operating temperature -196...+600 °C B 1/10 DIN, tolerance $\pm 1/10 \times (0.3 + 0.005 \times t)$, operating temperature -196...+600 °C
Tolerances thermocouple (IEC 60584)	Type J tolerance class 1 = -40...375 °C ± 1.5 °C, 375...750 °C $\pm 0.004 \times t$ Type K and N tolerance class 1 = -40...375 °C ± 1.5 °C, 375...1000 °C $\pm 0.004 \times t$
Temperature range Pt100	-200...+350 °C, depending on cable material
Temperature range thermocouple	-200...+350 °C, depending on thermocouple type and cable material
Approvals	ATEX, IECEx, EAC Ex, METROLOGICAL PATTERN APPROVAL
Quality certificate	ISO 9001:2015 and ISO 14001:2015 issued by DNV

Materials

These are the standard materials of components for the sensor types T-CABLE / W-CABLE.

- Cable/wires please see *Technical data*
- Heat shrink tube Irradiated Modified Polyolefin (max +125 °C), only on request, not used as standard
- Sensor element AISI 316L

Other materials can be used on request.

Installation instructions and example

Before any installation, make sure the target process/machinery and site are safe to work!

Make sure the cable type matches the temperature and chemical requirements of the site.

Installation phases:

- Install the sensor tip as close to the measured object as possible.
- Never bend the sensing element, it is rigid, non-bendable tube construction!
- Use fixing accessories applicable to each installation/site.
- Make sure there is no excess bending or pulling force loading the cable.
- Mount extra strain relief, e.g. cable tie, for cable, if necessary.

Image below: this example shows sensor installed with a special fixing device to an air duct pipe.

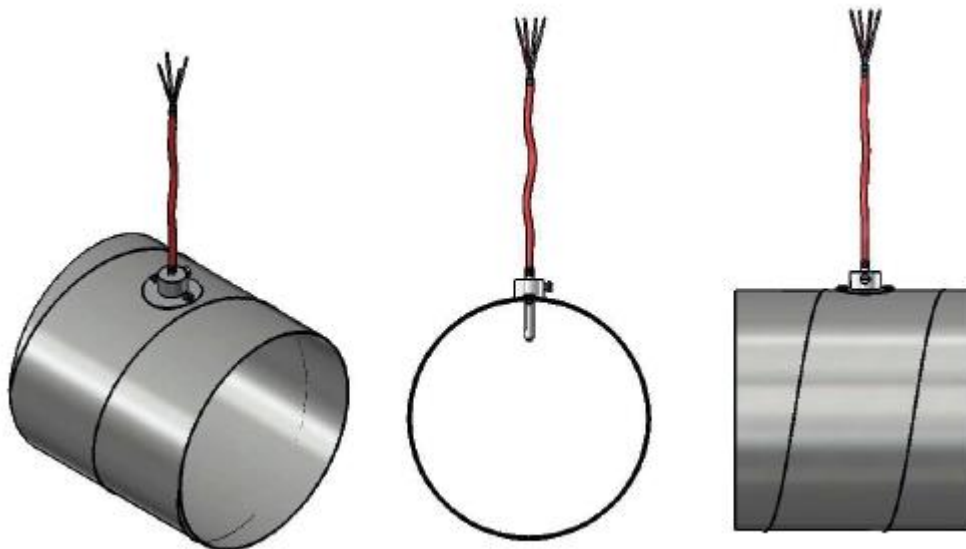

Tightening torques

Use only tightening torques allowed in applicable standards of each thread size and material.

Installation of accessories

Pipe fittings = pipe clamps:

There are stainless steel (1.4401) pipe clamp (hose clamp) components available also as accessories.

Installation phases:

- Select a suitable clamp size according to the pipe diameter.
- Or select a separate, 1-meter long strap part, and cut it in pieces of suitable lengths. Separate clamp parts for the strap can be ordered according to the need. Insert a clamp part to one end of the band.
- Apply the strap around the pipe, leaving the sensor element tip under the strap.
- Tighten the strap by twisting the screw clockwise, to give a secure thermal connection between sensor and pipe surface.

The components available are:

Product number	Type	Strap length/width	Material
915589	Pipe clamp	16-27/12MM	1.4401
1125786	Pipe clamp	25-40/12MM	1.4401
1125787	Pipe clamp	32-50/9MM	1.4401
1026077	Pipe clamp	50-70/12MM	1.4401
1228601	Pipe clamp	70-90/12MM	1.4401
5120444	Pipe clamp	90-110/12MM	1.4401
5120446	Pipe clamp	110-130/12MM	1.4401
5120448	Pipe clamp	130-150/12MM	1.4401
920556	Pipe strap	1METER/12MM	1.4401
920559	Pipe strap clamp	12MM	1.4401



Pt100; connection wiring

Image below: These are the connection colors of Pt100 resistor connections, according to standard EN 60751.

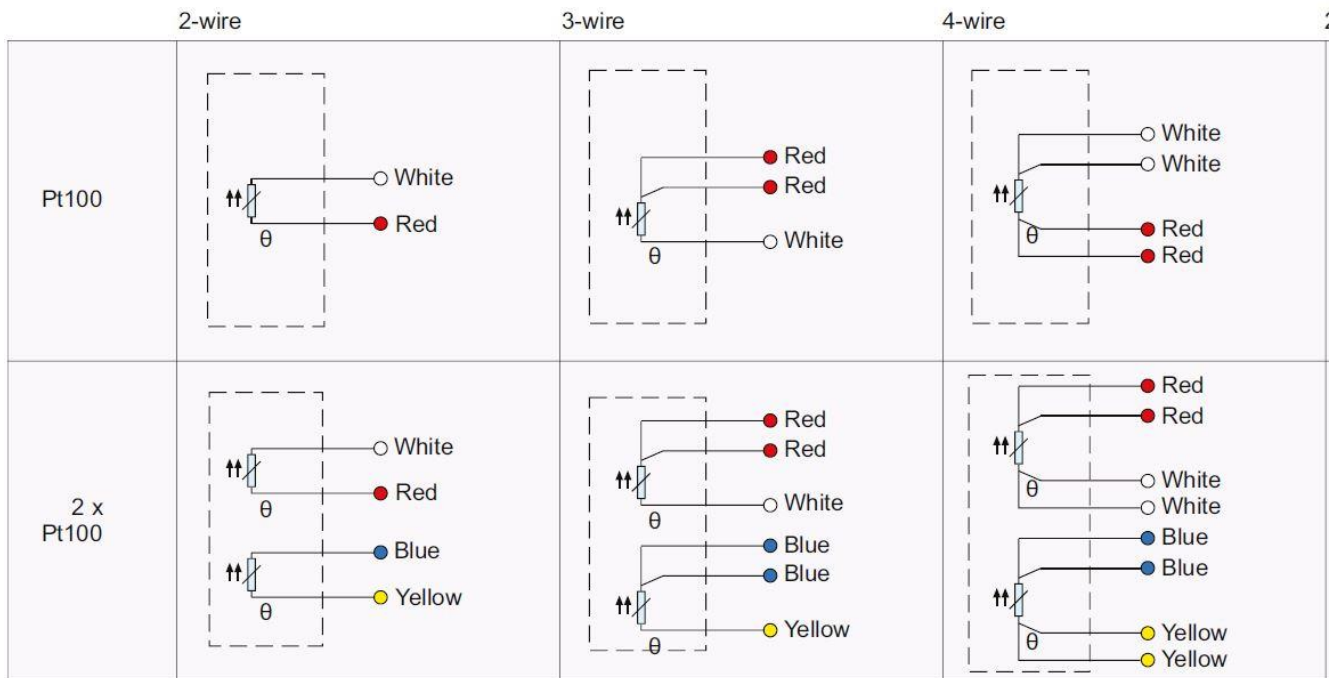

Other connections on request.

Pt100; measuring current

The highest allowed measuring current for Pt100 measuring resistors depends on resistor type and brand.

Normally the recommended maximum values are:

- Pt100 1 mA
- Pt500 0,5 mA
- Pt1000 0,3 mA.

Do not use higher measuring current. It will lead to false measurement values and might even destroy the resistor.

Above listed values are normal measuring current values. For Ex i certified sensor types, type designation -EXI-, higher values (worst case) are used for the self-heating calculation for safety reasons. For further details and calculation examples, please see ANNEX A.

TC; connection wiring

Image below: These are the connection colors of TC types J, K and N.

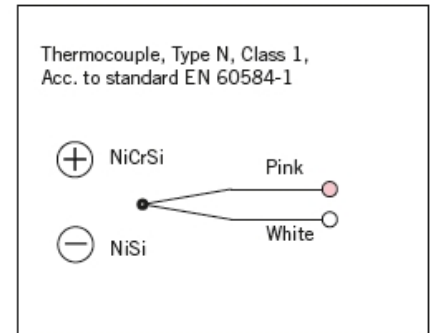
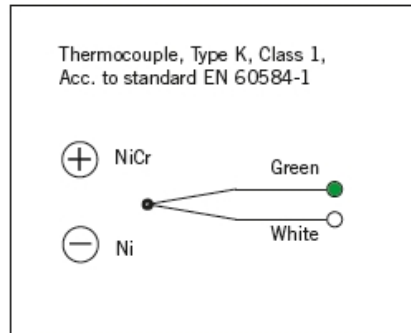
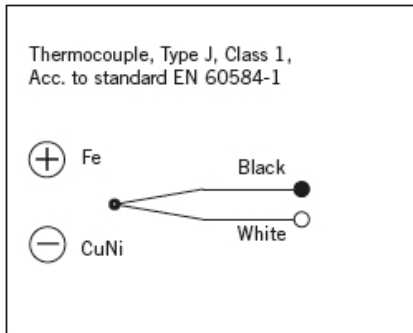

Other types on request.

TC; non-grounded or grounded types

Normally the thermocouple sensors are non-grounded, which means the protective tube / MI cable sheath is not connected to the thermo material hot junction, where two materials are welded together.

In special applications also grounded types are used.

NOTE! Non-grounded and grounded sensors cannot be connected to same circuits, make sure you are using the right type.

NOTE! Grounded TCs are not allowed for Ex i certified sensor types.

Image below: Non-grounded and grounded structures in comparison.

Non-grounded TC

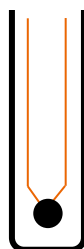











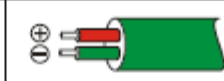

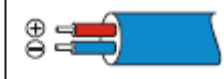
Thermo material hot junction and protective tube / MI cable sheath are galvanically isolated from each other.

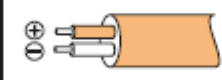
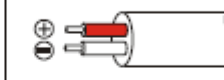
Grounded TC

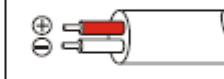

Thermo material hot junction has galvanic connection with protective tube / MI cable sheath.

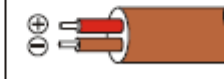
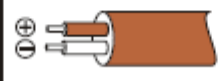
TC; thermocouple cable standards (color table)

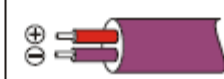
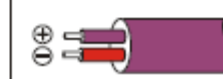
New standards:	IEC 60584-3	DIN EN 60584	ISA MC 96.1
Thermo Type	IEC 584	DIN 43714	ANSI MC 96.1
NiCr-Ni / K KCA: Fe-CuNi	 + green/ - white Jacket: green	 + red/ - green Jacket: green	 + yellow/ - red Jacket: yellow
Fe-CuNi / L		 + red/ - blue Jacket: blue	
Fe-CuNi / J	 + black/ - white Jacket: black		 + white/ - red Jacket: black
Pt10Rh-Pt / S SCA: E-Cu/A-Cu	 + orange/ - white Jacket: orange	 + red/ - white Jacket: white	 + black/ - red Jacket: green
Pt13Rh-Pt / R RCA: E-Cu/A-Cu	 + orange/ - white Jacket: orange	 + red/ - white Jacket: white	 + black/ - red Jacket: green
Pt30Rh-Pt6Rh / B BC: S-Cu/E-Cu	 + grey/ - white Jacket: grey		 + grey/ - red Jacket: grey
NiCrosil-Nisil / N NC: Cu-CuNi	 + pink/ - white Jacket: pink		
Cu-CuNi / U		 + red/ - brown Jacket: brown	
Cu-CuNi / T	 + brown/ - white Jacket: brown		
NiCr-CuNi / E	 + purple/ - white Jacket: purple	 + red/ - purple Jacket: purple	 + purple/ - red Jacket: purple

Type label of standard versions

Each sensor has a type label attached to it. It is a moisture and wear proof industrial grade sticker, with black text on white label. This label has printed information as presented below.

Image below: Example of a non-Ex sensor type label.



Manufacturer contact information.
For some sensor types, this may also be printed on a separate label for practical reasons.

Trade name
Type code
Product number
Serial number with production date
CE-mark (RoHS) | Serial number as QR code

Serial number information

Serial number S/N is always printed on type label in the following form: yymmdd-xxxxxxx-x:

- yymmdd production date, e.g. “210131” = 31.1.2021
- -xxxxxxx production order, e.g. “1234567”
- -x sequential ID number within this production order, e.g. “1”

Ex e data (only for types with Ex e approval)

The Ex e cable sensor types, with RTD sensing element, are available with ATEX, IECEx, EAC Ex and KCs approvals. The approved types are special versions, with type designation **WT-KAAPALI-...-EX**. Special data for use in Ex e applications is given in certificates.

Ex e certificates and Ex markings

Type Certificate number	Issued by	Applicable area	Marking
WT-KAAPALI-...-EX (non-bendable construction as standard type W-CABLE-...)			
ATEX EESF 18 ATEX 053X	Eurofins Expert Services Oy, Finland, Notified Body Nr 0537	Europe	Ex II 2G Ex e IIC T6...T3 Gb Ex II 2D Ex tb IIIC T60°C...T200°C Db
IECEx IECEx EESF 18.0025X	Eurofins Expert Services Oy, Finland, Notified Body Nr 0537	Global	Ex e IIC T6...T3 Gb Ex tb IIIC T60°C...T200°C Db
EAC Ex № EAЭC RU C- FI.AA71.B.00130-19	Lenpromexpertiza OOO, Russia	Eurasian Customs Union (Belarus, Kazakhstan, Russia)	1 Ex e IIC T6...T3 Gb X Ex tb IIIC T60°C..T200°C Db X
KCs 19-KA4BO-0462X	KTL Korean Testing Laboratory, South Korea	South Korea	Ex e IIC T6...T3

For certificate copies and special Ex e product data, please visit:

<https://www.epicsensors.com/en/products/temperature-sensors/exe-extb-temperature-sensors/>

Ex e type label

For ATEX, IECEx and KCs Ex e approved versions there is more information on the label, according to applicable standards. For these sensors, the manufacturer contact information is given on a separate label.

Image below: Example of an ATEX Ex e approved sensor type label.

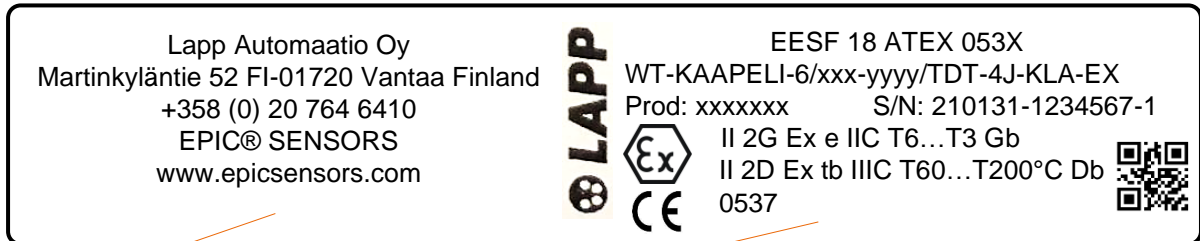

Manufacturer contact information. For some sensor types, this may also be printed on a separate label for practical reasons.

Ex certificate number(s)
 Type code
 Product number Serial number with production date
 Ex-mark (ATEX) Ex markings
 CE-mark (ATEX and RoHS) Serial number as QR code
 Notified body number
 Special technical values (if needed)

For EAC Ex e approved sensor versions, exported to Eurasian Customs Union area, there is a special type label.

Image below: Example of an EAC Ex-approved sensor type label.

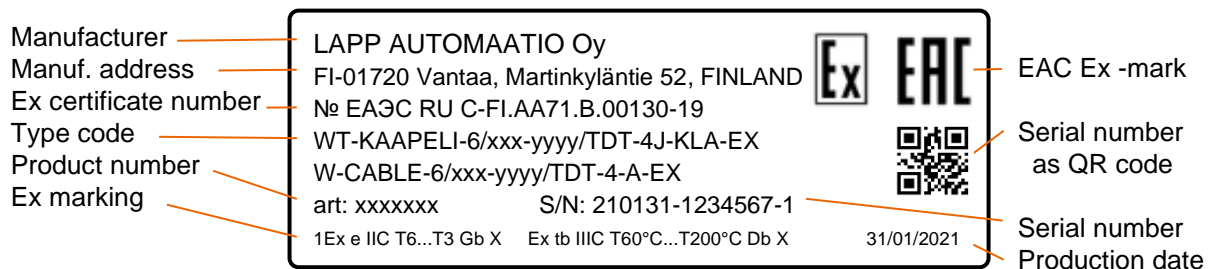

NOTE! After Ex approval processes our code key digits have changed to shorter form. Below please find a comparison of the old and new designations of one product type as an example.

Old: WT-KAAPELI-6/xxx-yyy/TDT-4J-KLA-EX (printed on current certificates)
 New: W-CABLE-6/xxx-yyy/TDT-4-A-EX (used in general product data)

Ex i data (only for types with Ex i approval)

This sensor type is available also with ATEX and IECEx Ex i approvals. Assembly consists of a temperature sensor with cable for connection (sensor type designation -EXI-). All relevant Ex data is given below.

Ex i – Special Conditions for Use

There are special specifications and conditions for use defined in certificates. These include e.g. Ex data, allowed ambient temperatures, and self-heating calculation with examples. These are presented in **Annex A: Specification and special conditions for use - Ex i approved EPIC®SENSORS temperature sensors.**

Ex i certificates and Ex markings

Certificate - Number	Issued by	Applicable area	Marking
ATEX – EESF 21 ATEX 043X	Eurofins Electric & Electronics Finland Oy, Finland, Notified Body Nr 0537	Europe	Ex II 1G Ex ia IIC T6...T3 Ga Ex II 1/2G Ex ib IIC T6...T3 Ga/Gb Ex II 1D Ex ia IIIC T135 °C Da Ex II 1/2D Ex ib IIIC T135 °C Da/Db
IECEx – IECEx EESF 21.0027X	Eurofins Electric & Electronics Finland Oy, Finland, Notified Body Nr 0537	Global	Ex ia IIC T6...T3 Ga Ex ib IIC T6...T3 Ga/Gb Ex ia IIIC T135 °C Da Ex ib IIIC T135 °C Da/Db

NOTE! Name change of the Notified Body Nr 0537:

- Until 31.3.2022, the name was: Eurofins Expert Services Oy
- As of 1.4.2022, the name is: Eurofins Electric & Electronics Finland Oy.

Ex i type label

For ATEX and IECEx Ex i approved versions there is more information on the label, according to applicable standards.

Image below: Example of an ATEX and IECEx Ex i approved sensor type label.



Manufacturer contact information.
For some sensor types, this may also be printed on a separate label for practical reasons.

Ex certificate number(s)
Type code
Product number Serial number with production date
Ex-mark (ATEX) Ex markings
CE-mark (ATEX and RoHS) Serial number as QR code
Notified body number
Special technical values (if needed)

EU Declaration of Conformity

The EU Declaration of Conformity, declaring products' conformance to the European Directives, is delivered with products or sent on request.

Manufacturer contact information

Manufacturer HQ main office:

Lapp Automaatio Oy
Street address Martinkyläntie 52
Postal address FI-01720 Vantaa, Finland

Production site and logistics:

Lapp Automaatio Oy
Street address Varastokatu 10
Postal address FI-05800 Hyvinkää, Finland

Phone (sales) +358 20 764 6410

Email epicsensors.fi.lav@lapp.com
Https www.epicsensors.com

Document history

Version / date	Author(s)	Description
20230707	LAPP/VeTe	Additional info for sensor cable installation.
20220822	LAPP/JuPi	Telephone number update
20220815	LAPP/JuPi	Material name text corrections
20220408	LAPP/JuPi	Minor text corrections
20220401	LAPP/JuPi	Original version

Although every reasonable effort is made to ensure the accuracy of the content of the operating instructions, Lapp Automaatio Oy is not responsible for the way the publications are used or for possible misinterpretations by end users. The user must ensure that she or he has the latest edition of this publication.

We reserve the right to make changes without prior notice. © Lapp Automaatio Oy

ANNEX A - Specification and special conditions for use - Ex i approved EPIC® SENSORS temperature sensors

Annex A, page 1/4

Ex data for RTD (resistance temperature sensor) and TC (Thermocouple temperature sensor)

Sensor Ex data, maximum interface values, without transmitter or / and display.

Electrical values	For Group IIC	For Group IIIC
Voltage U_i	30 V	30 V
Current I_i	100 mA	100 mA
Power P_i	750 mW	550 mW @ $T_a +100\text{ °C}$
		650 mW @ $T_a +70\text{ °C}$
		750 mW @ $T_a +40\text{ °C}$
Capacitance C_i	Negligible, *	Negligible, *
Inductance L_i	Negligible, *	Negligible, *

Table 1. Sensor Ex data.

* For sensors with long cable part, the parameters C_i and L_i must be included in the calculation.
Following values per meter can be used according to EN 60079-14:
 $C_{\text{cable}} = 200\text{ pF/m}$ and $L_{\text{cable}} = 1\text{ }\mu\text{H/m}$.

Allowed ambient temperatures - Ex i temperature class, without transmitter and/or display.

Marking, Gas Group IIC	Temperature class	Ambient temperature
II 1G Ex ia IIC T6 Ga II 1/2G Ex ib IIC T6-T3 Ga/Gb	T6	-40...+80 °C
II 1G Ex ia IIC T5 Ga II 1/2G Ex ib IIC T6-T3 Ga/Gb	T5	-40...+95 °C
II 1G Ex ia IIC T4-T3 Ga II 1/2G Ex ib IIC T6-T3 Ga/Gb	T4-T3	-40...+100 °C
Marking, Dust Group IIIC	Power P_i	Ambient temperature
II 1D Ex ia IIIC T135 °C Da II 1/2D Ex ib IIIC T135 °C Da/Db	750 mW	-40...+40 °C
II 1D Ex ia IIIC T135 °C Da II 1/2D Ex ib IIIC T135 °C Da/Db	650 mW	-40...+70 °C
II 1D Ex ia IIIC T135 °C Da II 1/2D Ex ib IIIC T135 °C Da/Db	550 mW	-40...+100 °C

Table 2. Ex i temperature classes and allowed ambient temperature ranges

Note!

The temperatures above are without cable glands.

The compatibility of cable glands must be according to the application specifications.

If the transmitter and/or display will be inside the transmitter housing, the specific Ex requirements of the transmitter and/or display installation must be noted.

The used materials must comply the needs of application, e.g., abrasion, and the temperatures above.

For EPL Ga Group IIC the aluminium parts in connection heads are subject to sparking by impacts or friction.

For Group IIIC the maximum input power P_i shall be observed.

When the sensors are mounted across boundary between different Zones, refer to standard IEC 60079-26 section 6, for ensuring the boundary wall between different hazardous areas.

ANNEX A - Specification and special conditions for use - Ex i approved EPIC® SENSORS temperature sensors

Annex A, page 2/4

Considering sensor self-heating

Self-heating of the sensor tip shall be considered in respect with Temperature Classification and associated ambient temperature range and manufacturer's instructions for calculating tip surface temperature according to thermal resistances stated in the instructions shall be observed.

Allowed ambient temperature range of sensor head or process connection for Groups IIC and IIIC with different temperature classes are listed in Table 2. For Group IIIC the maximum input power P_i shall be observed.

The process temperature shall not adversely affect ambient temperature range assigned for Temperature Classification.

Calculation for self-heating of the sensor at the tip of sensor or the thermowell tip

When the sensor-tip is located at environment where the temperature is within $T_6...T_3$, it is needed to consider the self-heating of the sensor. Self-heating is of particular significance when measuring low temperatures.

The self-heating at the sensor tip or thermowell tip depends on the sensor type (RTD/TC), the diameter of sensor and structure of sensor. It is also needed to consider the Ex i values for the transmitter. The table 3. shows the R_{th} values for different type of sensors structure.

Sensor type	Thermal resistance R_{th} [°C / W]					
	Resistance thermometer (RTD)			Thermocouple (TC)		
Measuring insert diameter	< 3 mm	3...<6 mm	6...8 mm	< 3 mm	3...<6 mm	6...8 mm
Without thermowell	350	250	100	100	25	10
With thermowell made from tube material (e.g. B-6k, B-9K, B-6, B-9, A-15, A-22, F-11, etc)	185	140	55	50	13	5
With thermowell – solid material (e.g. D-Dx, A-Ø-U)	65	50	20	20	5	1

Table 3. Thermal resistance based on Test report 211126

Note!

If the measuring device for RTD-measuring is using measuring current > 1 mA, the maximum surface temperature of the temperature sensor tip should be calculated and taken to account. Please see next page.

If sensor type has multiple sensing elements included, and those are used simultaneously, note that the maximum power for all sensing elements should not be more than the allowed total power P_i . Maximum power must be limited to 750 mW. This must be guaranteed by process owner. (Not applicable for Multi-point temperature sensor types T-MP / W-MP or T-MPT / W-MPT with segregated Exi circuits).

ANNEX A - Specification and special conditions for use - Ex i approved EPIC® SENSORS temperature sensors

Annex A, page 3/4

Calculation for maximum temperature:

The self-heating of the sensor tip can be calculated from formula:

$$T_{max} = P_o \times R_{th} + MT$$

- (T_{max}) = Maximum temperature = surface temperature at the sensor tip
- (P_o) = Maximum feeding power for the sensor (see the transmitter certificate)
- (R_{th}) = Thermal resistance (K/W, Table 3.)
- (MT) = Medium temperature.

Calculate the maximum possible temperature at the tip of sensor:

Example 1 - Calculation for RTD-sensor tip with thermowell

Sensor used at Zone 0

RTD sensor type: W-M-9K . . . (RTD-sensor with head-mounted transmitter).

Sensor with thermowell, diameter of Ø 9 mm.

Medium temperature (MT) is 120 °C

Measuring is made with PR electronics head mounted transmitter 5437D and isolated barrier PR 9106 B.

Maximum temperature (T_{max}) can be calculated by adding the temperature of the medium that you are measuring and the self-heating. The self-heating of the sensor tip can be calculated from the Maximum power (P_o) which is feeding the sensor and R_{th}-value of used sensor type. (See the Table 3.)

Supplied power by PR 5437 D is (P_o) = 23,3 mW (from the transmitter Ex-certificate)

Temperature class T4 (135 °C) must not be exceeded.

Thermal resistance (R_{th}) for the sensor is = 55 K/W (from Table 3).

Self-heating is 0.0233 W * 55 K/W = 1,28 K

Maximum temperature (T_{max}) is MT + self-heating: 120 °C + 1,28 °C = 121,28 °C

The result in this example shows that, the self-heating at the sensor tip is negligible.

The safety margin for (T₆ to T₃) is 5 °C and that must be subtracted from 135 °C; means that up to 130 °C would be acceptable. In this example the temperature of class T4 is not exceeded.

Example 2 - Calculation for RTD-sensor tip without the thermowell.

Sensor used at Zone 1

RTD sensor type: W-M-6/303 . . . (RTD-sensor with cable, without head-mounted transmitter)

Sensor without thermowell, diameter of Ø 6 mm.

Medium temperature (MT) is 40 °C

Measuring is made with rail-mounted PR electronics PR 9113D isolated transmitter/barrier.

Maximum temperature (T_{max}) can be calculated by adding the temperature of the medium that you are measuring and the self-heating. The self-heating of the sensor tip can be calculated from the Maximum power (P_o) which is feeding the sensor and R_{th}-value of used sensor type. (See the Table 3.)

Supplied power by PR 9113D is (P_o) = 40,0 mW (from the transmitter Ex-certificate)

Temperature class T3 (200 °C) must not be exceeded.

Thermal resistance (R_{th}) for the sensor is = 100 K/W (from Table 3).

Self-heating is 0.040 W * 100 K/W = 4,00 K

Maximum temperature (T_{max}) is MT + self-heating: 40 °C + 4,00 °C = 44,00 °C

The result in this example shows that, the self-heating at the sensor tip is negligible.

The safety margin for (T₆ to T₃) is 5 °C and that must be subtracted from 200 °C; means that up to 195 °C would be acceptable. In this example the temperature of class T3 is not exceeded.

ANNEX A - Specification and special conditions for use
- Ex i approved EPIC® SENSORS temperature sensors

Annex A, page 4/4

Additional information for Group II devices: (acc. to EN IEC 60079-0: 2019 section: 5.3.2.2 and 26.5.1)

Temperature class for T3 = 200 °C

Temperature class for T4 = 135 °C

Safety margin for T3 to T6 = 5 K

Safety margin for T1 to T2 = 10 K.

Note!

This ANNEX is an instructional document on specifications.

For original regulatory data on specific conditions for use, always refer to ATEX and IECEx certificates:

EESF 21 ATEX 043X
IECEx EESF 21.0027X