

THE WORLD OF LAPP

Innovations 2020



Legend for icons

INDUSTRIES

-  Automation
-  e-Mobility
-  Food & Beverage
-  Mechanical and Plant Engineering
-  Oil & Gas
-  Rail
-  Solar Energy
-  Wind Energy

PRODUCT CHARACTERISTICS

-  Suitable for outdoor use
-  Good chemical resistance
-  Flame-retardant
-  Wide clamping range
-  Halogen-free
-  Heat-resistant
-  Cold-resistant
-  Corrosion-resistant
-  Maximum vibration protection
-  Mechanical resistance
-  Assembly time
-  Low weight
-  Oil-resistant
-  Optimum strain relief
-  Space requirement
-  Power chain
-  Clean room
-  Robust
-  Acid-resistant
-  Reliability
-  Integrated SKINTOP® cable gland
-  Voltage
-  Connector with standard housing unit
-  Interference signals
-  Temperature-resistant
-  Torsion-resistant
-  Torsion load
-  UV-resistant
-  Waterproof
-  Variety of approval certifications

Please note: the purpose of the icons is to provide you with a quick overview and a rough indication of the product features to which the corresponding information relates. You can find details of product characteristics in the “technical data” sections on the product pages.

content



..... Company information 2



..... ÖLFLEX®
Power and control cables 6



..... ETHERLINE®
Data communication systems
for ETHERNET technology 26



..... HITRONIC®
Optical transmission systems 32



..... EPIC®
Industrial connectors 34



..... SKINTOP®
Cable glands 39



..... FLEXIMARK®
Marking systems 46



..... Tools and cable accessories 48



Andreas Lapp,
Matthias Lapp,
Ursula Ida Lapp,
Alexander Lapp,
Siegbert Lapp.

family

On course for success

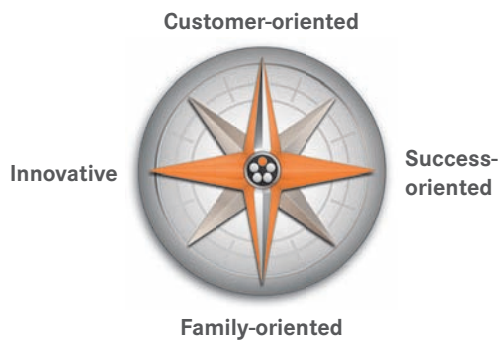

Family business and global player

LAPP is both. The history of our company has been one of success and expansion ever since it was founded in 1959 by Ursula Ida and Oskar Lapp. It remains resolutely family owned to this day. We safeguard our success by staying close to our customers and markets, maintaining our innovative strength and brand quality, and being a reliable partner. We provide continuity, always guided in our thoughts and actions by our values.

Success built on family values

At LAPP, we maintain values that promote cooperation and enable relationships with employees, suppliers and customers based on partnership and trust. Good relations and mutual respect are key elements of our company culture and a central plank of company policy. We know that our successful business development of the last decades is down in particular to our 4,245 skilled and dedicated staff around the world, as well as the reliable partnership with our customers.

With 17 production facilities, over 44 own sales companies and hundreds of dedicated consultants, we are always close to the individual needs and challenges of our customers all over the globe. We are constantly developing our products and system solutions, setting standards in safety, quality and functionality. This is why we are one of the world's leading manufacturers of integrated solutions and branded products in cable and connection technology. As our success story enters its third generation, we are aware of our duty to the future.

> www.lappkabel.com/company



innovations

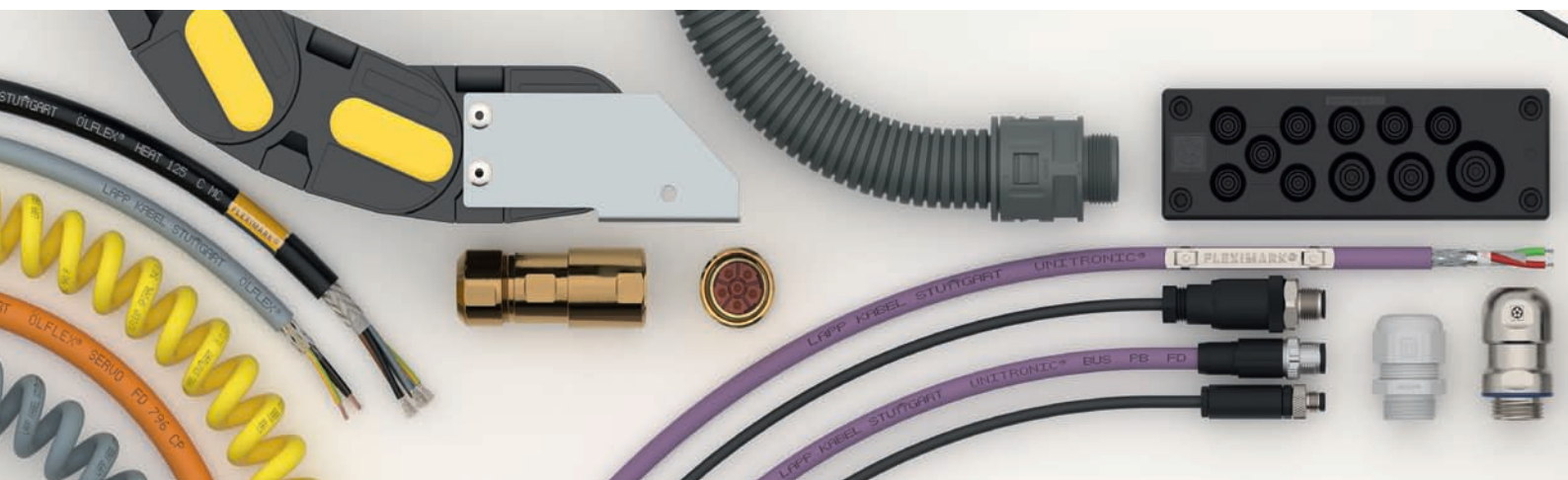

Connecting the future

As happens so often with new innovations, it all started with a problem. It was the 1950s, a time when individual cores had to be painstakingly inserted into sleeving. Oskar Lapp took a close look at the conventional wires and cables of the day and was convinced that he could find a better solution. He thought, he tinkered, and eventually developed the world's first industrially produced control cable. This product became the bedrock on which

LAPP built its reputation, not only as a manufacturer of cable and system solutions in Germany, but also as a global leader in innovation and quality.

Given the name ÖLFLEX®, Oskar Lapp's invention was groundbreaking in several ways. The oil-resistant and flexible control cable was delivered as a finished product, with multiple conductor cores stranded and surrounded by a protective sheath.

Alongside this, the new cable simplified the allocation of the individual cores with a revolutionary idea that went on to become standard. Oskar Lapp introduced the system of colour coding for single cores, saving his customers an enormous amount of work.

Innovations like these make life easier and generate value. Through his ingenuity, Oskar Lapp set the course for his business.

The perfect partner

History has shown that LAPP has always seen itself as a problem solver and a partner to which customers come for solutions. It has constantly strived to shape the world of tomorrow. As Oskar Lapp liked to say: **“Cables connect the present and the future”**.

Innovations have been part of the LAPP DNA since the very beginning. The data transmission systems UNITRONIC®, ETHERLINE® and HITRONIC®, for example, not only deliver value, but ensure peace of mind for the long term with

cutting-edge technology developed by LAPP itself. From sensor/actuator connections, complex network structures with bus systems using UNITRONIC® cables, and robust cable components for Profinet, EtherCAT or EtherNet/IP systems with ETHERLINE® to secure and reliable data transmission at the speed of light with HITRONIC®, LAPP is the perfect partner for premium, tailor-made connections from A to B.

This is the result of decades of development work and constant innovation in the

core business of cable and connection solutions. One example of this is the modular, easily configurable industrial connector EPIC®, which offers excellent robustness and safety during connection and disconnection. Another product, the SKINTOP® cable gland, perfectly sums up what makes LAPP solutions stand apart: a simple system that delivers perfect results effortlessly. In this case, the cable is automatically secured, centred and sealed with optimum strain relief.

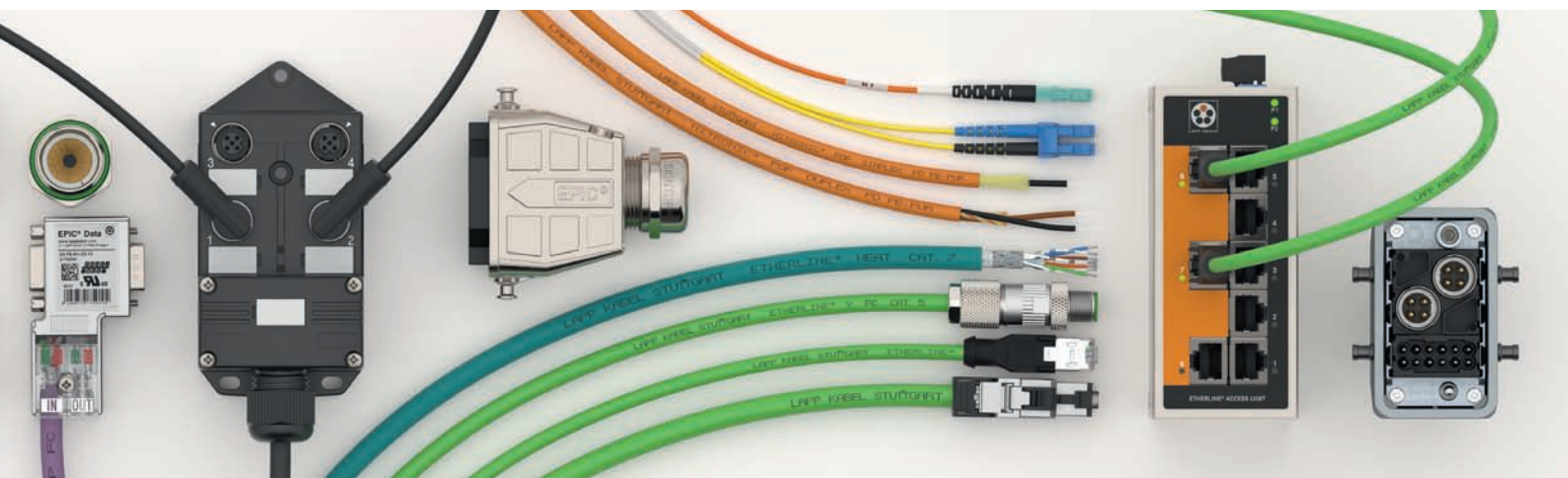

Making solutions possible

SILVYN® is another example of a product designed with durability in mind. Being future ready is not just a matter of technology. Equally important is the longevity of the individual components. The protective cable conduit systems in the SILVYN® range maintain LAPP's guaranteed quality against even extreme external chemical and mechanical loads. The SILVYN® CHAIN cable chains are designed to fulfil this function in dynamic applications.

The FLEXIMARK® range of customised marking solutions are also made to last.

For LAPP, the challenge is not simply a matter of providing the right components. Instead, it is about developing products that help customers overcome challenges and that meet their needs. The LAPP Group's search for innovations that solve problems is a global one. It maintains local partnerships on the

ground and delivers a service that keeps its promises wherever the customer is. It is this combination of product and service that helps LAPP stand apart.

The quality of the goals determines the quality of the future. Oskar Lapp kept his eye on both, and became one of history's great innovators.



ÖLFLEX® CLASSIC 115 CY BK

Screened PVC control cable with small outer diameter and black outer sheath



Info

- With black outer sheath, UV-resistant
- Thin and light, without inner sheath
- EMC-compliant

Norm references / Approvals

- Based on EN 50525-2-51

Product Make-up

- Fine-wire strand made of bare copper wires
- PVC insulation LAPP P8/1
- Cores twisted in layers
- Plastic foil wrapping
- Tinned-copper braiding
- PVC outer sheath, black

Technical data

Classification ETIM 5/6
ETIM 5.0/6.0 Class-ID: EC000104
ETIM 5.0/6.0 Class-Description: Control cable

Core identification code
Black with white numbers acc. to VDE 0293-334

Conductor stranding
Fine wire according to VDE 0295, class 5/IEC 60228 class 5

Torsion movement in WTG
TW-0 & TW-1, refer to Appendix T0

Minimum bending radius
Occasional flexing: 20 x outer diameter
Fixed installation: 6 x outer diameter

Nominal voltage
U0/U: 300/500 V

Test voltage
Core/core: 4000 V
Core/screen: 2000 V

Protective conductor
G = with GN-YE protective conductor
X = without protective conductor

Temperature range
Occasional flexing: -5°C to +70°C
Fixed installation: -40°C to +80°C

Benefits

- Suitable for outdoor applications
- Space-saving installation due to small cable diameters

Application range

- Measurement and control technology
- Plant engineering
Industrial machinery
Heating and air-conditioning systems
- Conveyor and transport systems
- Suitable for torsional applications which are typical for the loop in wind turbine generators (WTG)
- Suitable for outdoor applications

Product features

- UV and weather-resistant according to ISO 4892-2
- Flame-retardant according IEC 60332-1-2
- Good chemical resistance, see catalogue appendix T1
- High degree of screening
low transfer impedance
(max. 250 Ω/km at 30 MHz)

Article number	Number of cores and mm ² per conductor	Outer diameter [mm]	Copper index (kg/km)	Weight (kg/km)
ÖLFLEX® CLASSIC 115 CY BK				
1136510	2 X0.5	5.8	36	54
1136511	3 G0.5	6.1	43	63
1136512	3 X0.5	6.1	43	63
1136513	4 G0.5	6.5	49	71
1136514	4 X0.5	6.5	49	71
1136515	5 G0.5	7.0	57	86
1136516	5 X0.5	7.0	57	86
1136517	7 G0.5	7.5	69	105
1136518	7 X0.5	7.5	69	105
1136519	12 G0.5	9.9	104	163
1136520	12 X0.5	9.9	104	163
1136521	18 G0.5	11.5	141	226
1136522	25 G0.5	13.4	211	350
1136523	2 X0.75	6.2	43	59
1136110	3 G0.75	6.5	52	76
1136525	3 X0.75	6.5	52	76
1136111	4 G0.75	7.0	61	91
1136527	4 X0.75	7.0	61	91
1136113	5 G0.75	7.7	72	100
1136529	5 X0.75	7.7	72	100
1136114	7 G0.75	8.3	89	127
1136531	7 X0.75	8.3	89	127
1136115	12 G0.75	10.9	138	232
1136533	18 G0.75	12.7	211	292
1136534	25 G0.75	14.8	280	435
1136535	2 X1.0	6.5	51	71
1136536	3 G1.0	6.8	62	86
1136537	3 X1.0	6.8	62	86
1136538	4 G1.0	7.3	74	98
1136539	4 X1.0	7.3	74	98
1136540	5 G1.0	8.1	88	121
1136541	5 X1.0	8.1	88	121

Article number	Number of cores and mm ² per conductor	Outer diameter [mm]	Copper index (kg/km)	Weight (kg/km)
1136542	7 G1.0	8.8	112	147
1136543	7 X1.0	8.8	112	147
1136544	12 G1.0	11.5	185	249
1136545	18 G1.0	13.9	268	364
1136546	25 G1.0	15.9	354	486
1136547	2 X1.5	7.1	65	86
1136548	3 G1.5	7.5	82	112
1136549	3 X1.5	7.5	82	112
1136550	4 G1.5	8.2	100	135
1136551	4 X1.5	8.2	100	135
1136552	5 G1.5	8.9	119	148
1136553	5 X1.5	8.9	119	148
1136554	7 G1.5	9.9	154	192
1136555	7 X1.5	9.9	154	192
1136556	12 G1.5	13.0	268	332
1136557	18 G1.5	15.6	373	484
1136558	25 G1.5	17.9	530	734
1136559	34 G1.5	20.8	683	944
1136560	3 G2.5	8.9	118	151
1136561	4 G2.5	9.9	147	188
1136562	5 G2.5	11.0	176	224
1136563	7 G2.5	11.9	253	294
1136564	12 G2.5	16.0	355	521
1136565	18 G2.5	19.0	569	740
1136566	4 G4.0	11.6	248	287
1136567	4 G6.0	14.2	343	424
1136568	4 G10.0	17.2	495	637
1136569	5 G10.0	19.5	592	824
1136570	4 G16.0	20.2	800	1050
1136571	5 G16.0	22.6	895	1285
1136572	4 G25.0	25.1	1075	1413
1136573	4 G35.0	28.0	1576	1867

Unless specified otherwise, the shown product values are nominal values. Detailed values (e.g. tolerances) are available upon request.
Copper price basis: EUR 150/100 kg. Refer to catalogue appendix T17 for the definition and calculation of copper-related surcharges.
Please find our standard lengths at: www.lappkabel.de/en/cable-standardlengths / Packaging size: coil ≤ 30 kg or ≤ 250 m, otherwise drum
Please specify the preferred type of packaging (e.g. 1 x 500 m drum or 5 x 100 m coils).
Photographs and graphics are not to scale and do not represent detailed images of the respective products.

Similar products

- ÖLFLEX® ROBUST 215 C refer to main catalogue 2020/21
- ÖLFLEX® CLASSIC 110 CY BLACK 0,6/1 kV refer to main catalogue 2020/21

Accessories

- SKINTOP® BRUSH ADD-ON refer to main catalogue 2020/21
- 3M Scotch™ 1183 screening tape refer to main catalogue 2020/21
- SKINTOP® MS-M BRUSH refer to main catalogue 2020/21



ÖLFLEX® CLASSIC 128 H BK 0,6/1 kV

Cost-effective halogen-free control cable with improved fire characteristics, 0,6/1kV

i Info

- For space-saving and cost-effective installation
- For use within public buildings and industrial plants
- UV and weather-resistant according to ISO 4892-2



Benefits

- Space-saving installation due to small cable diameters
- Easy installation due to flexible design

Application range

- Public buildings
- Plant engineering
Industrial machinery
Heating and air-conditioning systems
- Particularly where human and animal life as well as valuable property are exposed to high risk of fire hazards
- Suitable for outdoor applications

Product features

- Flame-retardant according to IEC 60332-1-2 (flame spread on a single cable)
- No flame-propagation according to IEC 60332-3-24 respectively IEC 60332-3-25 (Flame spread on vertical cable or wire bundle)
- Halogen-free according to IEC 60754-1 (amount of halogen acid gas)
Corrosiveness of combustion gases according to IEC 60754-2 (degree of acidity)
- Low smoke density according to IEC 61034-2
- UV and weather-resistant according to ISO 4892-2
- Ozone-resistant according to EN 50396

Norm references / Approvals

- Based on EN 50525-3-11

Product Make-up

- Fine-wire strand made of bare copper wires
- Core insulation: Halogen-free
- Outer sheath made of special halogen-free compound, black

Technical data

Classification ETIM 5/6
ETIM 5.0/6.0 Class-ID: EC000057
ETIM 5.0/6.0 Class-Description: Low voltage power cable

Core identification code
Up to 5 cores: colour-coded according to VDE 0293-308, refer to Appendix T9
From 6 cores: black with white numbers

Conductor stranding
Fine wire according to VDE 0295 Class 5 / IEC 60228 Class 5

Minimum bending radius
Occasional flexing: 15 x outer diameter
Fixed installation: 4 x outer diameter

Nominal voltage
U0/U: 600/1000 V

Test voltage
4000 V

Protective conductor
G = with GN-YE protective conductor
X = without protective conductor

Temperature range
Occasional flexing: -5°C to +70°C
Fixed installation: -40°C to +80°C

Article number	Number of cores and mm² per conductor	Outer diameter [mm]	Copper index (kg/km)	Weight (kg/km)
ÖLFLEX® CLASSIC 128 H BK 0,6/1 kV				
1123520	2 X 1.0	7.4	19.2	76
1123521	3 G 1.0	7.8	28.8	101
1123522	4 G 1.0	8.4	38.4	120
1123523	5 G 1.0	9.2	48	143
1123524	7 G 1.0	9.9	67.2	179
1123525	12 G 1.0	12.8	115.2	283
1123528	2 X 1.5	8.4	28.8	112
1123529	3 G 1.5	8.9	43.2	135
1123530	4 G 1.5	9.6	57.6	163
1123531	5 G 1.5	10.5	72	196
1123532	7 G 1.5	11.4	100.8	253
1123533	12 G 1.5	15.1	172.8	396
1123534	18 G 1.5	18.0	259.2	589

Article number	Number of cores and mm² per conductor	Outer diameter [mm]	Copper index (kg/km)	Weight (kg/km)
1123535	25 G 1.5	21.1	360	801
1123537	3 G 2.5	10.1	72	189
1123538	4 G 2.5	11.0	96	232
1123539	5 G 2.5	12.1	120	279
1123541	12 G 2.5	17.9	288	603
1123544	3 G 4.0	11.4	115.2	260
1123545	4 G 4.0	12.5	153.6	322
1123546	5 G 4.0	13.7	192	387
1123548	4 G 6.0	13.9	230.4	431
1123549	5 G 6.0	15.8	288	533
1123550	4 G 10.0	17.9	384	734
1123551	4 G 16.0	20.7	614.4	1080
1123552	5 G 16.0	23.0	768	1303
1123553	4 G 25.0	25.2	960	1617

Unless specified otherwise, the shown product values are nominal values. Detailed values (e.g. tolerances) are available upon request.
Copper price basis: EUR 150/100 kg. Refer to catalogue appendix T17 for the definition and calculation of copper-related surcharges.
Please find our standard lengths at: www.lappkabel.de/en/cable-standardlengths
Packaging size: coil ≤ 30 kg or ≤ 250 m, otherwise drum
Please specify the preferred type of packaging (e.g. 1 x 500 m drum or 5 x 100 m coils).
Photographs and graphics are not to scale and do not represent detailed images of the respective products.

Similar products

- ÖLFLEX® CLASSIC 130 H BK 0,6/1 kV refer to main catalogue 2020/21

Accessories

- SKINTOP® ST-HF-M refer to main catalogue 2020/21



ÖLFLEX® CLASSIC 128 CH BK 0,6/1 kV

Cost-effective halogen-free control cable with improved fire characteristics, 0,6/1kV, with screen



Info

- For space-saving and cost-effective installation
- For use within public buildings and industrial plants
- EMC/Screened

Benefits

- Easy installation due to flexible design
- Space-saving installation due to small cable diameters

Application range

- Public buildings
- Plant engineering
Industrial machinery
Heating and air-conditioning systems
- Particularly where human and animal life as well as valuable property are exposed to high risk of fire hazards
- Suitable for outdoor applications
- In EMC-sensitive environments (electromagnetic compatibility)

Product features

- Flame-retardant according to IEC 60332-1-2 (flame spread on a single cable)
- No flame-propagation according to IEC 60332-3-24 respectively IEC 60332-3-25 (Flame spread on vertical cable or wire bundle)
- Halogen-free according to IEC 60754-1 (amount of halogen acid gas)
Corrosiveness of combustion gases according to IEC 60754-2 (degree of acidity)
- Low smoke density according to IEC 61034-2
- UV and weather-resistant according to ISO 4892-2
- Ozone-resistant according to EN 50396

Norm references / Approvals

- Based on EN 50525-3-11

Product Make-up

- Fine-wire strand made of bare copper wires
- Core insulation: Halogen-free
- Halogen-free plastic foil wrapping
- Tinned-copper braiding
- Outer sheath made of special halogen-free compound, black

Technical data

- Classification ETIM 5/6**
ETIM 5.0/6.0 Class-ID: EC000057
ETIM 5.0/6.0 Class-Description: Low voltage power cable
- Core identification code**
Up to 5 cores: colour-coded according to VDE 0293-308, refer to Appendix T9
From 6 cores: black with white numbers
- Conductor stranding**
Fine wire according to VDE 0295, class 5/IEC 60228 class 5
- Minimum bending radius**
Occasional flexing: 20 x outer diameter
Fixed installation: 6 x outer diameter
- Nominal voltage**
U0/U: 600/1000 V
- Test voltage**
Core/core: 4000 V
Core/screen: 2000 V
- Protective conductor**
G = with GN-YE protective conductor
X = without protective conductor
- Temperature range**
Occasional flexing: -5 °C to +70 °C
Fixed installation: -40 °C to +80 °C

Article number	Number of cores and mm ² per conductor	Outer diameter [mm]	Copper index (kg/km)	Weight (kg/km)
ÖLFLEX® CLASSIC 128 CH BK 0,6/1 kV				
1123557	2 X 1.0	8.2	39.5	107
1123558	3 G 1.0	8.6	51	129
1123559	4 G 1.0	9.2	62.8	153
1123560	5 G 1.0	10.0	76	181
1123561	7 G 1.0	10.7	97.2	220
1123562	12 G 1.0	14.0	169.1	343
1123564	25 G 1.0	19.0	315.5	667
1123565	2 X 1.5	9.2	53.2	135
1123566	3 G 1.5	9.7	69.5	164
1123567	4 G 1.5	10.4	86.5	199
1123568	5 G 1.5	11.3	104.3	236
1123569	7 G 1.5	12.2	136.5	292
1123570	12 G 1.5	16.3	238.3	498

Article number	Number of cores and mm ² per conductor	Outer diameter [mm]	Copper index (kg/km)	Weight (kg/km)
1123571	18 G 1.5	19.4	355.4	700
1123573	2 X 2.5	10.4	79.4	176
1123574	3 G 2.5	10.9	106.1	218
1123575	4 G 2.5	11.8	134.3	268
1123576	5 G 2.5	12.9	158.3	322
1123577	7 G 2.5	14.4	225	411
1123578	12 G 2.5	19.3	383.6	704
1123579	18 G 2.5	23.0	548.9	1058
1123580	25 G 2.5	26.8	761.7	1449
1123582	4 G 4.0	13.5	211.9	357
1123583	5 G 4.0	14.9	250.3	434
1123584	3 G 6.0	13.7	232.1	372
1123585	4 G 6.0	15.1	298.5	472
1123586	5 G 6.0	16.8	356.1	611

Unless specified otherwise, the shown product values are nominal values. Detailed values (e.g. tolerances) are available upon request.

Copper price basis: EUR 150/100 kg. Refer to catalogue appendix T17 for the definition and calculation of copper-related surcharges.

Please find our standard lengths at: www.lappkabel.de/en/cable-standardlengths

Packaging size: coil ≤ 30 kg or ≤ 250 m, otherwise drum

Please specify the preferred type of packaging (e.g. 1 x 500 m drum or 5 x 100 m coils).

Photographs and graphics are not to scale and do not represent detailed images of the respective products.

Similar products

- ÖLFLEX® CLASSIC 135 CH BK 0,6/1 kV refer to main catalogue 2020/21

Accessories

- SKINTOP® BRUSH ADD-ON refer to main catalogue 2020/21
- SKINTOP® MS-HF-M BRUSH refer to main catalogue 2020/21
- SKINTOP® MS-M BRUSH refer to main catalogue 2020/21



i Info

- Flexible Cord STOOW for NEC Extra-hard usage in the USA
- Broad application range (NFPA 70/NEC), NFPA 79 compliance
- FT4 + OIL RES I/II

ÖLFLEX® POWER MULTI
Flexible, oil resistant Power Cord: (UL) listed for Tray + Extra-hard usage per NEC; NFPA 79



Benefits

- Suitability for different operation types and locations in the USA as per NFPA/NEC under one LAPP part number, thanks to UL listings (UL) STOOW and (UL) TC, resp. TC-ER, as well as thanks to design and characteristics associated with these listings
- Apart from unprotected laying on tray in the USA thanks to TC(-ER) listing: ...further, normatively specified, unprotected wiring methods in the USA per application related NEC Articles, thanks to (UL) listing STOOW/ Extra-hard usage Flexible Cord

Application range

- Industrial machinery, plant engineering in the USA
- Unprotected 600V operation on cable tray in the USA, incl. 6 ft. Exposed Run laying sections for version with at least 3 conductors
- As per Article 400 of NEC/ NFPA 70: General Uses Permitted in the USA and General Uses Not Permitted to the overall group of Flexible Cords and Flexible Cables acc. to UL 62; Operating bids and limitations for Flexible Cords in special applications acc. to further NEC Articles, such as 501 (Class I Locations), 422 (Appliances), or 520 (specific locations for play and production of entertainment), etc.
- Further, typical locations in the USA, as specified by respective US installation standardization (e.g., NEC/ NFPA 70): Power cord for equipment, paint booths, appliances, factory installations (branch circuit), any power hook-up in the plant, for harnessed power connecting or extension cord set assemblies
- In hazardous locations in the USA, as per Chapter 5 of NEC/ NFPA 70: Classes I thru III, Divisions 1 and 2 each, plus intrinsically safe circuits, taking account of:
 - Provisions on cable design, cable type, installation, application in NEC Chapter 5 (esp.: Articles 500 thru 504);
 - This cable's design, approvals, component identification

Product features

- Highly flame retardant FT4
- Highly oil resistant OIL RES I/II
- Tested sunlight resistant per UL 1277, UL 62, UL 2556 in terms of UV resistance
- Tested for unprotected, direct burial in the USA per UL 1277

Norm references / Approvals

- Certified by UL per UL 1277 for TC 600V use in the USA, subject to individual third-party inspection: Generally UL Type TC (Tray Cable), and for at least 3 or more conductors TC-ER (Tray Cable for Exposed Run) in addition [UL CCN: QPOR; UL File No.: E171371]
- Certified by UL per UL 62 for STOOW use in the USA, subject to individual third-party inspection: UL Type STOOW (Extra-hard usage Flexible Cord) [UL CCN: ZJCZ; UL File No.: E146118]
- Certified by UL per CSA C22.2 No. 239, and CSA C22.2 No. 230 for possible CIC/TC use in Canada, subject to individual third-party inspection: c(UL) CIC/TC FT4 [UL CCN: QPOR7; UL File No.: E171371]
- Certified by UL per CSA C22.2 No. 49 for STOOW use in Canada, subject to individual third-party inspection: c(UL) STOOW [UL CCN: ZJCZ7; UL File No.: E146118]
- Certified by CSA per CSA C22.2 No. 210 for AWM use in Canada, subject to individual third-party inspection: CSA AWM II A/B FT4

Product Make-up

- Fine-wire strand made of bare copper wires
- Specially formulated PVC insulation
- Durable, black sheath made of specially formulated thermoplastic polymer for improved service life

Technical data

Classification ETIM 5/6
ETIM 5.0/6.0 Class-ID: EC001578
ETIM 5.0/6.0 Class-Description: Flexible cable

Core identification code
- Coloured conductors with numbers, plus ground in green/yellow (30 % stripe width);
- For 2-conductor cable only: No green/ yellow ground
- Example 3 conductors:
BLACK conductor: „1 - ONE“
WHITE conductor: „2 - TWO“
GREEN/YELLOW conductor: No Numbers
- Colour code:
2C: Black, White
3C: Black, White, Green-Yellow
4C: Black, White, Red, Green-Yellow
5C: Black, White, Red, Brown, Green-Yellow
6C or more: Black with white numbers, except for the included Green-Yellow ground

Conductor stranding
Fine wire according to DIN EN 60228 (VDE 0295), class 5 / IEC 60228 class 5

Minimum bending radius
Installation: 4 x outer diameter

Nominal voltage
UL/CSA TC/STOOW: 600 V
IEC U0/U: 300/500 V

Test voltage
2000 V

Protective conductor
G = with GN-YE protective conductor

Temperature range
UL/CSA TC: -25°C to +90°C;
Occasional flexing/ North America: -25°C to +105°C;
Fixed installation/ North America: -40°C to 105°C

Article number	Number of cores and mm ² per conductor	Outer diameter [mm]	Copper index (kg/km)	Weight (kg/km)
ÖLFLEX® POWER MULTI				
611803	3 G 1.0	9.4	29.763	92
611804	4 G 1.0	10.1	38.692	106
611805	5 G 1.0	12.0	49.109	122
611603	3 G 1.5	10.1	43.157	110
611604	4 G 1.5	10.9	58.038	128
611605	5 G 1.5	12.9	72.027	153
611612	12 G 1.5	18.3	172.775	330
611618	18 G 1.5	20.9	259.237	440
611625	25 G 1.5	24.5	360.134	598

Article number	Number of cores and mm ² per conductor	Outer diameter [mm]	Copper index (kg/km)	Weight (kg/km)
611403	3 G 2.5	13.8	72.027	137
611404	4 G 2.5	14.8	96.73	167
611405	5 G 2.5	16.8	120.541	198
611203	3 G 4.0	16.0	115.183	188
611205	5 G 4.0	18.8	191.972	286
611003	3 G 6.0	17.2	172.775	342
611004	4 G 6.0	18.6	230.664	402
610803	3 G 10.0	21.3	288.702	641
610804	4 G 10.0	24.0	383.944	844

Unless specified otherwise, the shown product values are nominal values. Detailed values (e.g. tolerances) are available upon request.
Copper price basis: EUR 150/100 kg. Refer to catalogue appendix T17 for the definition and calculation of copper-related surcharges.
Please find our standard lengths at: www.lappkabel.de/en/cable-standardlengths / Packaging size: coil ≤ 30 kg or ≤ 250 m, otherwise drum
Please specify the preferred type of packaging (e.g. 1 x 610 m drum or 8 x 76 m coils).
Photographs and graphics are not to scale and do not represent detailed images of the respective products. / *OD = Outer diameter

Harsh conditions • High mechanical and chemical resistance



ÖLFLEX® 409 CP

Screened, abrasion- and oil-resistant PUR control cable for increased application requirements - certified



Info

- Oil resistant and abrasion-proof
- UL/cUL certified for North America
- EMC compliant copper screening

Benefits

- Increased durability under harsh conditions thanks to robust PUR outer sheath
- Resistant to contact with many mineral oil-based lubricants, diluted acids, aqueous alkaline solutions and other chemical media
- Certified for the USA and Canada for export-oriented machine, appliance and apparatus manufacturers
- Copper braiding screens the cable against electromagnetic interference

Application range

- Appliance and apparatus construction
- Industrial machinery and machine tools
- Measurement, control and electrical applications
- Very suitable for oily wet areas within machinery and production lines that are subject to normal mechanical stress
- Under consideration of the temperature range also suitable for outdoor use

Product features

- High oil-resistance
- Flame-retardant
- Abrasion and notch-resistant
- UV-resistant according to ISO 4892-2
- Resistant to hydrolysis and microbes

Norm references / Approvals

- UL AWM Style 20234
- CUL AWM I/II A/B
- UL File No. E63634

Product Make-up

- Fine-wire, bare copper conductor
- Core insulation: special PVC
- Cores twisted in layers
- Plastic foil wrapping
- Tinned-copper braiding
- Special polyurethane outer sheath (PUR)
- Sheath colour: black (similar RAL 9005)

Technical data

Classification ETIM 5/6
ETIM 5.0/6.0 Class-ID: EC000104
ETIM 5.0/6.0 Class-Description: Control cable

Core identification code
Black with white numbers acc. to VDE 0293-334

Conductor stranding
Fine wire according to VDE 0295, class 5/IEC 60228 class 5

Minimum bending radius
Occasional flexing: 15 x outer diameter
Fixed installation: 4 x outer diameter

Nominal voltage
U₀/U: 300/500 V
UL/CSA: 1000 V

Test voltage
4000 V

Protective conductor
G = with GN-YE protective conductor
X = without protective conductor

Temperature range
Occasional flexing: -5 °C to +70 °C (UL: +80 °C)
Fixed installation: -40 °C to +80 °C

Article number	Number of cores and mm ² per conductor	Outer diameter [mm]	Copper index (kg/km)	Weight (kg/km)
ÖLFLEX® 409 CP				
1321852	2 X 0.75	7.0	29	75
1321103	3 G 0.75	7.3	37	89
1321104	4 G 0.75	7.8	44	104
1321105	5 G 0.75	8.4	53	120
1321107	7 G 0.75	9.0	67	146
1321110	10 G 0.75	10.9	94	196
1321112	12 G 0.75	11.2	107	219
1321118	18 G 0.75	12.9	152	298
1321125	25 G 0.75	14.8	200	387
1321902	2 X 1.0	7.3	34	84
1321203	3 G 1.0	7.6	43	99
1321204	4 G 1.0	8.1	53	116
1321205	5 G 1.0	8.8	64	137
1321207	7 G 1.0	9.4	83	167
1321210	10 G 1.0	11.5	116	228
1321212	12 G 1.0	11.8	133	255
1321218	18 G 1.0	13.8	191	355
1321225	25 G 1.0	15.7	272	474
1321952	2 X 1.5	7.9	43	99

Article number	Number of cores and mm ² per conductor	Outer diameter [mm]	Copper index (kg/km)	Weight (kg/km)
1321303	3 G 1.5	8.3	57	119
1321304	4 G 1.5	8.9	71	143
1321305	5 G 1.5	9.6	85	167
1321307	7 G 1.5	10.3	112	207
1321312	12 G 1.5	13.3	182	326
1321318	18 G 1.5	15.3	277	464
1321325	25 G 1.5	17.5	375	609
1321403	3 G 2.5	9.6	86	166
1321404	4 G 2.5	10.3	110	203
1321405	5 G 2.5	11.2	134	243
1321407	7 G 2.5	12.1	178	305
1321412	12 G 2.5	15.8	311	503
1321504	4 G 4.0	11.9	163	276
1321505	5 G 4.0	13.2	199	340
1321604	4 G 6.0	13.4	232	368
1321605	5 G 6.0	14.7	284	450
1321704	4 G 10.0	16.8	397	644
1321705	5 G 10.0	18.7	486	785
1321804	4 G 16.0	19.6	639	931
1321805	5 G 16.0	22.4	786	1142

Unless specified otherwise, the shown product values are nominal values. Detailed values (e.g. tolerances) are available upon request.

Copper price basis: EUR 150/100 kg. Refer to catalogue appendix T17 for the definition and calculation of copper-related surcharges.

Please find our standard lengths at: www.lappkabel.de/en/cable-standardlengths

Packaging size: coil ≤ 30 kg or ≤ 250 m, otherwise drum

Please specify the preferred type of packaging (e.g. 1 x 500 m drum or 5 x 100 m coils).

Photographs and graphics are not to scale and do not represent detailed images of the respective products.



ÖLFLEX® SERVO 2XSLCH-JB

EMC-optimised motor cable, low-capacitance, double screened and halogen-free with improved fire behaviour

i Info

- EMC-optimised design
- Halogen-free and highly flame-retardant
- 3+3 symmetry reduces common-mode interference effects and bearing currents



Benefits

- EMC-compliant installation of power drive systems conforming to EN 61800-3
- High power transmission for large drives
- Low capacitance design enables longer cable connection between frequency converter and motor
- Symmetrical 3+3 Version supports the reduction of damaging bearing currents
- Reduction of flame propagation, density and toxicity of smoke gases in event of fire

Application range

- Connecting cable between frequency converter and motor
- In dry, damp or wet interiors
- Paper industry, automotive industry
- Food production and packaging machinery
- Machine tools

Product features

- Low-capacitance design
- Fire behaviour:
 - Flame-retardant (IEC 60332-1-2)
 - Halogen-free (IEC 60754-1)
 - No corrosive gases (IEC 60754-2)
 - Low smoke density (IEC 61034-2)
 - Low toxicity (EN 50305)
- No flame-propagation according to IEC 60332-3-24 respectively IEC 60332-3-25 (Flame spread on vertical cable or wire bundle)

Norm references / Approvals

- Based on VDE 0276, 0250, 0207

Product Make-up

- Fine-wire, bare copper conductor
- Core insulation: XLPE
- Cores twisted concentrically (symmetrically splitted protective conductor of 3+3 version is gusset-filling divided between the power cores)
- Screening: wrapping of laminated aluminium foil in combination with tinned copper braiding
- Outer sheath: Halogen-free special compound, colour black (RAL 9005)

Technical data

- Classification ETIM 5/6**
ETIM 5.0/6.0 Class-ID: EC000057
ETIM 5.0/6.0 Class-Description: Low voltage power cable
- Core identification code**
Colours according to HD 308 S2
VDE 0293-308
- Conductor stranding**
Fine wire according to VDE 0295 Class 5 / IEC 60228 Class 5
- Minimum bending radius**
Occasional flexing: 15 x outer diameter
Fixed installation: 4 x outer diameter
- Nominal voltage**
U0/U: 600/1000 V
- Test voltage**
Core/Core: 4 kV
Core/Screen: 4 kV
- Protective conductor**
G = with GN-YE protective conductor
X = without protective conductor
Protective conductor of 3+3 version is gusset-filling divided between power cores
- Temperature range**
Flexing: -15°C to +90°C
Fixed installation: -40°C to +90°C

Article number	Number of cores and mm ² per conductor	Outer diameter [mm]	Copper index (kg/km)	Weight (kg/km)
ÖLFLEX® SERVO 2XSLCH-JB / 4-core version				
1133500	4 G1.5	10,9	95	230
1133501	4 G2.5	11,8	150	300
1133502	4 G4.0	14,1	235	485
1133503	4 G6.0	15,5	320	630
1133504	4 G10.0	18,2	533	860
1133505	4 G16.0	20,6	789	1290
1133506	4 G25.0	24,9	1236	1860
1133507	4 G35.0	27,9	1662	2610
1133508	4 G50.0	33,9	2345	2950
1133509	4 G70.0	38,9	3196	3950
1133510	4 G95.0	44,2	4316	5300
1133511	4 G120.0	51,3	5435	6600
1133512	4 G150.0	55,5	6394	7043
1133513	4 G185.0	60,5	7639	8384

Article number	Number of cores and mm ² per conductor	Outer diameter [mm]	Copper index (kg/km)	Weight (kg/km)
ÖLFLEX® SERVO 2XSLCH-JB / 3+3 core version				
1133514	3 X 1,5 + 3 G 0,25	10,9	88	140
1133515	3 X 2,5 + 3 G 0,5	11,7	144	220
1133516	3 X 4 + 3 G 0,75	13,0	224	323
1133517	3 X 6 + 3 G 1	14,3	276	420
1133518	3 X 10 + 3 G 1,5	16,7	491	615
1133519	3 X 16 + 3 G 2,5	18,9	723	819
1133520	3 X 25 + 3 G 4	22,5	1136	1325
1133521	3 X 35 + 3 G 6	25,5	1535	1718
1133522	3 X 50 + 3 G 10	30,9	2156	2399
1133523	3 X 70 + 3 G 10	35,2	2871	3056
1133524	3 X 95 + 3 G 16	39,9	3953	4162
1133525	3 X 120 + 3 G 16	46,1	4836	5074
1133526	3 X 150 + 3 G 25	50,0	5412	6128
1133527	3 X 185 + 3 G 35	54,5	7041	7500
1133528	3 X 240 + 3 G 50	62,9	8986	9770

Unless specified otherwise, the shown product values are nominal values. Detailed values (e.g. tolerances) are available upon request.
 Copper price basis: EUR 150/100 kg. Refer to catalogue appendix T17 for the definition and calculation of copper-related surcharges.
 Please find our standard lengths at: www.lappkabel.de/en/cable-standardlengths
 Packaging size: coil ≤ 30 kg or ≤ 250 m, otherwise drum
 Please specify the preferred type of packaging (e.g. 1 x 500 m drum or 5 x 100 m coils).
 Photographs and graphics are not to scale and do not represent detailed images of the respective products.

Similar products

- ÖLFLEX® SERVO 9YSLCY-JB refer to main catalogue 2020/21
- ÖLFLEX® SERVO 2YSLCY-JB refer to main catalogue 2020/21

Accessories

- SKINTOP® BRUSH ADD-ON refer to main catalogue 2020/21
- SKINTOP® MS-SC-M refer to main catalogue 2020/21
- SKINTOP® MS-M BRUSH refer to main catalogue 2020/21



ÖLFLEX® SERVO 3D 7DSL

Low capacitive hybrid servo cable with PUR outer sheath for three-dimensional robotic application - certified



Info

- One cable solution for servo drives
- Suitable for Hiperface DSL® and SCS open link interfaces
- 3D - Simultaneous bending and torsion

Benefits

- Allows much faster speed and accelerations which increases the economic efficiency of the machines
- Only one connection line between drive and motor-feedback system. Instead of the encoder cable a specific integrated data pair takes over the signalling.
- Less cables and reduced connection costs
- Space and weight savings thanks to hybrid cable design
- Increased durability under harsh conditions thanks to robust PUR outer sheath
- Resistant to contact with many mineral oil-based lubricants, diluted acids, aqueous alkaline solutions and other chemical media

Application range

- Connecting cable between servo controller and motor
- In industrial robots, moving machine parts or drag chains
- Automated handling equipment
- Particularly in wet areas of machine tools and transfer lines
- Inside of dresspacks of buckling arm robots and for use for gantry robots
- For indoor and outdoor use

Product features

- High oil-resistance
- Abrasion and notch-resistant
- Flammability: UL/CSA: VW-1, FT1 IEC/EN: 60332-1-2
- Flexible at low temperatures
- Low-capacitance design

Norm references / Approvals

- UL AWM Style 21223 cRU AWM I/II A/B FT1
- UL File No. E63634
- Designed for up to 5 million torsion cycles
- For use in power chains: Please comply with assembly guideline Appendix T3

Product Make-up

- Extra-fine-wire, bare copper conductor (power cores and control pair) and 19-wire, tinned copper conductor (data pair)
- Core insulation: Polypropylene (PP) respectively fluorinated ethylene propylene (FEP)
- Power cores with screened control pair and data pair twisted together
- Special tape wrapping
- Spiral shield made of tinned copper wires
- Wrapping of PTFE tape
- PUR outer sheath, black (similar RAL 9005)

Technical data

Classification ETIM 5/6
ETIM 5.0/6.0 Class-ID: EC000104
ETIM 5.0/6.0 Class-Description: Control cable

Core identification code
Power cores: black with marking U/L1/C/L+; V/L2; W/L3/D/L-; GN/YE protective conductor
Data pair: white, blue
Control pair: black, white

Conductor stranding
Extra-fine wire according to VDE 0295, class 6/IEC 60228 class 6
DSL data pair: 19-wired

Torsion
Torsion load max. ± 180 °/m

Minimum bending radius
Moved: 10 x outer diameter
Fixed installation: 5 x outer diameter

Nominal voltage
Power and control cores: IEC: U0/U: 600/1000 V
UL: 600 V
Data pair UL: 600 V

Test voltage
Power and control: 4 kV
Data pair: 1kV

Protective conductor
G = with GN-YE protective conductor

Temperature range
Flexing: -40°C to +80°C
Fixed installation: -50°C to +80°C

Article number	Number of cores and mm ² per conductor	Outer diameter [mm]	Copper index (kg/km)	Weight (kg/km)
ÖLFLEX® SERVO 3D 7DSL				
1023351	4 G 0,5 + (2 x 0,25) + (2 x 26AWG)	9.4	70	130
1023352	4 G 1,5 + (2 x 1,0) + (2 x 22AWG)	13.3	152	276
1023353	4 G 2,5 + (2 x 1,0) + (2 x 22AWG)	14.4	195	326

Unless specified otherwise, the shown product values are nominal values at room temperature. Detailed values (e.g. tolerances) are available upon request.
Copper price basis: EUR 150/100 kg. Refer to catalogue appendix T17 for the definition and calculation of copper-related surcharges.

Please find our standard lengths at: www.lappkabel.de/en/cable-standardlengths

HIPERFACE DSL® is a registered trademark of SICK AG, ACURO®link and SCS open link are registered trademarks of Hengstler GmbH
Photographs and graphics are not to scale and do not represent detailed images of the respective products.

Similar products

- ÖLFLEX® SERVO 7DSL refer to main catalogue 2020/21
- ÖLFLEX® SERVO FD 7DSL refer to main catalogue 2020/21
- ÖLFLEX® SERVO FD 70CS refer to page 13

Accessories

- Protective cable conduit systems and cable carrier systems refer to main catalogue 2020/21
- Circular connectors refer to main catalogue 2020/21



ÖLFLEX® SERVO FD 70CS

Low capacitive hybrid servo cables with PUR outer sheath for highly dynamic power chain application - certified

i Info

- One cable solutions for servo drives
- Suitable for various OEM transmission protocols
- Extended Line Performance - High power chain requirements



Benefits

- Allows much faster speed and accelerations which increases the economic efficiency of the machines
- Only one connection line between drive and motor-feedback system. Instead of the encoder cable integrated data pairs, quads or signal cores take over the signalling.
- Less cables and reduced connection costs
- Space and weight savings thanks to hybrid cable design
- Increased durability under harsh conditions thanks to robust PUR outer sheath
- Resistant to contact with many mineral oil-based lubricants, diluted acids, aqueous alkaline solutions and other chemical media

Application range

- Power drive systems in automation engineering
- Connecting cable between servo controller and motor
- In power chains or moving machine parts
- For use in assembling & pick-and-place machinery
- Particularly in wet areas of machine tools and transfer lines
- For indoor and outdoor use

Product features

- OCS - One Cable Solution
- High oil-resistance
- Abrasion and notch-resistant
- Flammability:
UL/CSA: VW-1, FT1
IEC/EN: 60332-1-2
- Halogen-free materials
- Flexible at low temperatures

Norm references / Approvals

- UL AWM Style 21223 or 20233
cRU AWM I/II A/B FT1
- UL File No. E63634
- For use in power chains: Please comply with assembly guideline Appendix T3

Product Make-up

- Extra-fine or fine wired conductor made of bare or tinned copper
- Core insulation: polypropylene (PP)
- Individual design depending on the item: power cores with screened control pair or bundle and specific data pairs, quads or signal cores twisted together
- Non-woven wrapping
- Tinned-copper braiding
- PUR outer sheath, orange (RAL 2003)

Technical data

- Classification ETIM 5/6**
ETIM 5.0/6.0 Class-ID: EC000104
ETIM 5.0/6.0 Class-Description: Control cable
- Core identification code**
Details see datasheet
- Conductor stranding**
Power cores and brake pairs or triplets: Extra-fine wire according to VDE 0295, class 6/IEC 60228 class 6
Signal cores, data pairs or star quads: Fine-wired
- Minimum bending radius**
Flexing: 7.5 x outer diameter
Fixed installation: 5 x outer diameter
- Nominal voltage**
Power and control cores:
Version 1,3 & 4: IEC U₀/U 600/1000 V
Version 2: IEC 300 V
UL all versions: see data sheet
Individual data pairs and quads: see data sheet
- Test voltage**
Details see datasheet
- Protective conductor**
G = with GN-YE protective conductor
- Temperature range**
Flexing: -40°C to +80°C
Fixed installation: -50°C to +80°C

Article number	Number of cores and mm ² per conductor	Outer diameter [mm]	Copper index (kg/km)	Weight (kg/km)
70CS Version 1				
1023375	4 G 1,5 + (2 x 0,75) + (4 x 24AWG)	13.3	154	252
70CS Version 2				
1023378	4 G 22AWG + (2 x 22AWG) + (4 x 26AWG)	9.8	75	128
1023379	4 G 19AWG + (2 x 21AWG) + (4 x 26AWG)	10.6	100	159
70CS Version 3				
1023370	4 G 1,5 + (2 x 0,75) + (2 x 24AWG + 2 x 2 x 28AWG)	13.6	153	248
1023371	4 G 2,5 + (2 x 1,0) + (2 x 24AWG + 2 x 2 x 28AWG)	14.7	202	306
1023372	4 G 4 + (2 x 1,0) + (2 x 24AWG + 2 x 2 x 28AWG)	16.0	270	394
70CS Version 4				
1023382	4 G 1,5 + (3 x 1,0) + (1 x 20AWG)	13.6	170	275
1023383	4 G 2,5 + (3 x 1,0) + (1 x 20AWG)	15.0	215	326
1023384	4 G 4 + (3 x 1,0) + (1 x 20AWG)	16.2	284	420

Unless specified otherwise, the shown product values are nominal values at room temperature. Detailed values (e.g. tolerances) are available upon request.

Copper price basis: EUR 150/100 kg. Refer to catalogue appendix T17 for the definition and calculation of copper-related surcharges.

Please find our standard lengths at: www.lappkabel.de/en/cable-standardlengths

Photographs and graphics are not to scale and do not represent detailed images of the respective products.

Similar products

- ÖLFLEX® SERVO 7DSL refer to main catalogue 2020/21
- ÖLFLEX® SERVO FD 7DSL refer to main catalogue 2020/21

Accessories

- Protective cable conduit systems and cable carrier systems refer to main catalogue 2020/21
- Circular connectors refer to main catalogue 2020/21



ÖLFLEX® SERVO FD 7TCE

Highly flexible, low capacitive servo motor cable with TC-ER (UL) or c(UL)-Listing for North America



Info

- Core Line Performance - Medium to increased travel lengths or acceleration
- Wide application range (NFPA 70/NEC)/ compliance with NFPA 79 for industrial machinery
- Low-capacitance design

Benefits

- Multi-standard certification offers universal application range, reduces part varieties and saves costs
- TC-ER and Flexible Motor Supply Cable listings enable open wiring on cable trays as well as the static or highly flexible usage for industrial machines with the same cable
- Cost-saving, easy installation due to omission of closed raceways (suitable for open wiring)
- Low capacitance design enables longer cable connection between frequency converter and motor
- Resistant to contact with many mineral oil-based lubricants, diluted acids, aqueous alkaline solutions and other chemical media
- Ideal for export-oriented machinery and equipment manufacturers thanks to high normative acceptance by the North American NEC (National Electrical Code)

Application range

- Connecting cable between servo controller and motor
- In power chains or moving machine parts
- Static open wiring on and between cable tray an industrial machine acc. NEC
- Industrial machinery and machine tools
- Linear robots, automated handling equipment
- Assembly lines, production lines, in all kinds of machines

Product features

- Oil-resistant according to UL OIL RES I & II
- Flame-retardant according to CSA FT4 UL Vertical-Tray Flame Test
- -40°C Cold Bend; -25°C Cold Impact; 90°C Wet or Dry
- Sunlight Resistant
- Direct Burial (according US standard)
- Low capacitance

Norm references / Approvals

- UL TC-ER (exposed run) per UL 1277
- Flexible Motor Supply Cable per UL 2277
- Class 1 Division 2 per NEC Article 501
- C(UL) CIC FT4 (18AWG - 14AWG); cRU AWM I/II A/B FT4
- For use in power chains: Please comply with assembly guideline Appendix T3

Product Make-up

- Extra-fine wire strand made of bare copper
- Core insulation: EPR compound
- Individual design depending on the item: power cores without or with one or two individually screened control core pairs twisted together in short lay lengths
- Non-woven wrapping
- Tinned-copper braiding
- Outer sheath: Specially formulated thermoplastic elastomer (TPE), orange

Technical data

Classification ETIM 5/6
ETIM 5.0 Class-ID: EC000057
ETIM 5.0 Class-Description: Low voltage power cable

Core identification code
Power cores: black with marking U/L1/C/L+; V/L2; W/L3/D /L-; GN/YE protective conductor
Optional designs with one pair of control cores: black; white
Two pairs of control cores: black with white numbers: 5, 6, 7, 8

Certifications
USA: UL TC-ER, Flexible Motor Supply
Canada: c(UL) CIC/TC FT4, cRU AWM I/II A/B FT4

Conductor stranding
Extra-fine wire according to VDE 0295, class 6/IEC 60228 class 6

Minimum bending radius
Flexing: up from 7.5 x outer diameter
Fixed installation: 5 x outer diameter

Nominal voltage
UL TC: 600V
UL Flexible Motor Supply: 1000V
c(UL) CIC/TC: 600V
cRU AWM: 1000V
IEC U0/U: 600/1000 V

Test voltage
Core/Core: 4 kV
Core/Screen: 2 kV

Protective conductor
G = with GN-YE protective conductor

Bending cycles & operation parameters
See Selection Table A2-1 in the appendix of our online catalogue

Temperature range
Flexing: -5°C to +90°C
Fixed installation: -40°C to +90°C

Article number	Number of cores and mm ² per conductor	Outer diameter [mm]	Copper index (kg/km)	Weight (kg/km)
ÖLFLEX® SERVO FD 7TCE				
700750	4 G 1.5	10.2	90.782	174
700751	4 G 2.5	11.4	141.382	230
700752	4 G 4.0	13.1	200.911	319
700753	4 G 6.0	15.0	282.763	431
700754	4 G 1,5 + (2 x 1,5)	12.7	144.358	259
700755	4 G 2,5 + (2 x 1,5)	13.8	199.423	356
700756	4 G 4 + (2 x 1,5)	16.1	273.834	447
700757	4 G 6 + (2 x 1,5)	17.1	345.269	537
700758	4 G 1 + 2 x (2 x 1,0)	13.3	151.799	280
700759	4 G 1,5 + 2 x (2 x 1,0)	14.8	190.493	355
700760	4 G 2,5 + 2 x (2 x 1,0)	15.9	277.699	410
700761	4 G 4 + (2 x 1,0) + (2 x 1,5)	17.9	318.481	525
700762	4 G 6 + (2 x 1,0) + (2 x 1,5)	18.8	389.916	613

Unless specified otherwise, the shown product values are nominal values at room temperature. Detailed values (e.g. tolerances) are available upon request.

Copper price basis: EUR 150/100 kg. Refer to catalogue appendix T17 for the definition and calculation of copper-related surcharges.

Please find our standard lengths at: www.lappkabel.de/en/cable-standardlengths

Photographs and graphics are not to scale and do not represent detailed images of the respective products.

Accessories

- Circular connectors refer to main catalogue 2020/21
- EMC refer to main catalogue 2020/21

DC application for the industry

Direct current (DC) serves as a future key technology for the integration of renewable energy sources and helps to avoid energy conversions within the production process. A simplified energy exchange between energy source and production plant/machine parts, as well as a process-optimized storage connection are

important advantages of this technology in order to be able to implement an intelligent energy supply in the industry. Lapp is working intensively on solutions and can actively contribute to the implementation and application of direct current in the production process with the following portfolio.

ÖLFLEX® DC – Product range

Product	Application range	Nominal voltage (power cores)	Cross section (mm ²) (power cores)	Temperature
ÖLFLEX® DC 100	Power cable for fixed installation and occasional flexible use	0,75/ 1,5 kV DC	1,5 - 185	Flexible: -5°C to +70°C Fixed installation: -40°C to +80°C
ÖLFLEX® DC SERVO 700	Power cable for DC drives & daisy chain applications	0,75/ 1,5 kV DC	2,5	Flexible: -5°C to +70°C Fixed installation: -40°C to +80°C
ÖLFLEX® DC CHAIN 800	Power cable for highly flexible use in constant motion within drag chains	0,75/ 1,5 kV DC	0,5 - 35	Flexible: -40°C to +105°C Fixed installation: -50°C to +105°C
ÖLFLEX® DC ROBOT 900	Power cable for highly flexible use with continuously alternating bending and torsional motion	0,75/ 1,5 kV DC	0,5 - 35	Flexible: -35°C to +90°C Fixed installation: -50°C to +90°C

Direct current improves energy and resource efficiency

Increase of availability

- Stability of energy networks due to reduced harmonics

Resource efficiency

- Less components and less space required
- Less wiring efforts

Energy efficiency

- Cross-machine recuperation
- Reduction of conversion losses from AC to DC
- Easier integration of renewable, decentralized energy sources

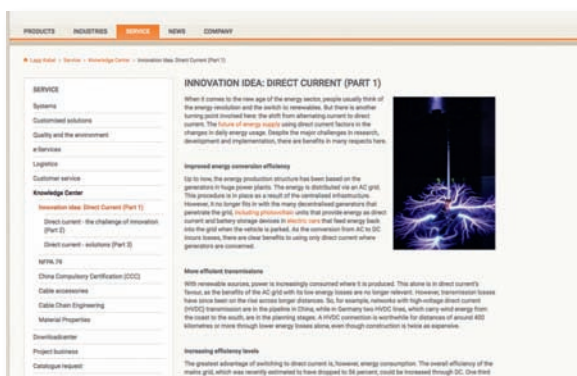

Knowledge Center

You can get further information online:

www.lappkabel.com/service/knowledge-center/innovation-idea-direct-current-part-1



Single core and Infrastructure





H07V-U

European <HAR> cable type certification

i Info

- CPR: Article number choice under www.lappkabel.com/cpr
- <HAR>
- Lengths suitable for TRONIC single core modules



Benefits

- Cables' <HAR> marking also stands for the international endorsement of national certification institutes' testing marks and certificates, e. g. <VDE><HAR>. The <HAR> marking is of special importance in case of goods traffic between European countries.

Application range

- Laying in tubes, exposed or buried in plaster, and in closed installation ducts
- For direct laying on racks, troughs and tubes only as potential equalisation conductor

Product features

- Flame-retardant according IEC 60332-1-2

Norm references / Approvals

- <HAR> cable type certification acc. EN 50525-2-31
- No cable type certified core insulation colours according to EN 50525-1/ VDE 0285-525-1: transparent, green (single colour), yellow (single colour), all double colours (except of green-yellow and yellow-green)

Product Make-up

- Solid bare copper conductor
- Core insulation: Based on PVC

Technical data

- Classification ETIM 5/6**
ETIM 5.0/6.0 Class-ID: EC000993
ETIM 5.0/6.0 Class-Description: Single core cable
- Conductor stranding**
Massive conductor according to VDE 0295 Class 1/ IEC 60228 Class 1
- Minimum bending radius**
According to EN 50565-1
Fixed installation: 4 x outer diameter
- Nominal voltage**
U0/U: 450/750 V
- Test voltage**
2500 V
- Current rating**
VDE 0298 Part 4
EN 50565-1/ VDE 0298-565-1
- Temperature range**
Fixed installation: -40°C to +80°C
Moved: +5°C to +70°C

Conductor cross-section (mm ²)	Outer diameter [mm]	m/ring	Copper index (kg/km)	Weight (kg/km)	grey	white	red	violet	blue
1.5	3.2 - 2.6	350	14.4	22	4527061X	4527051X	4527041X	4527071X	4527021X
2.5	3.9 - 3.2	200	24	37	4527062X	4527052X	4527042X	4527072X	4527022X

Conductor cross-section (mm ²)	Outer diameter [mm]	m/ring	Copper index (kg/km)	Weight (kg/km)	brown	black	green/yellow
1.5	3.2 - 2.6	350	14.4	22	4527031X	4527011X	4527001X
2.5	3.9 - 3.2	200	24	37	4527032X	4527012X	4527002X

Unless specified otherwise, the shown product values are nominal values. Detailed values (e.g. tolerances) are available upon request.
 Copper price basis: EUR 150/100 kg. Refer to catalogue appendix T17 for the definition and calculation of copper-related surcharges.
 Packaging size: Coil ≤ 30 kg, otherwise drum
 Photographs and graphics are not to scale and do not represent detailed images of the respective products.
 *for conventional use, **for careful bending; „OD“ = outer diameter

Similar products

- MULTI-STANDARD SC 2.1 refer to main catalogue 2020/21
- MULTI-STANDARD SC 2.2 refer to main catalogue 2020/21

Accessories

- DIN assorted boxes conductor end sleeves refer to main catalogue 2020/21
- PEW 8.87 crimping pliers refer to main catalogue 2020/21
- FLEXIMARK® Collar Snap-on refer to main catalogue 2020/21
- Mobile crimp tool crimping pliers refer to main catalogue 2020/21



N2XSY

PVC medium voltage cable with copper conductor



Info

- 3 voltage classes: 6/10 kV, 12/20 kV, 18/30 kV
- With copper conductor

Application range

- Power and control cable for fixed installation in the following applications:
- In water, in ground, outdoors and indoors
- In cable trays for power stations, industry, and distribution networks
- Burial without additional, suitable underground protection according to HD 620/VDE 0276-620 - Part 10-C (point 4): normal minimum installation depth 0.6 m, but at least 0.8 m under roads

VDE 0276-620, Part 10-C, point 5) when used outdoors; but always taking into consideration corrections/reductions to the current rating that may be necessary according to VDE 0298-4, and VDE 0298-4 (also refer to the catalogue appendix T12) for installation in and on buildings

Norm references / Approvals

- HD 620/ VDE 0276-620

Product Make-up

- Copper conductor
- Abbreviation „rm“:
r = round conductor form;
m = multi-wire conductor
- Core insulation: Cross-linked Polyethylen (XLPE)
- Screen made of copper wires with one or two copper bond counter spiral
- Outer sheath: PVC, red

Product features

- Flame-retardant according IEC 60332-1-2
- Current rating according to HD 620/ VDE 0276-620, Part 10-C, Table 7 (buried at +20 °C ground temperature according to HD 620/VDE 0276-620, Part 10-C, point 5) for routing underground and Table 8 (in the air at an air temperature of +30 °C according to HD 620/

Technical data

Classification ETIM 5/6
ETIM 5.0/6.0 Class-ID: EC001140
ETIM 5.0/6.0 Class-Description:
Medium voltage power cable

Conductor stranding
Multi-wire

Minimum bending radius
Fixed installation: 15 x outer diameter

Nominal voltage
U₀/U: 6/10 kV, 12/20 kV, 18/30 kV

Test voltage
Depending on nominal voltage:
6/10 kV: 15 kV
12/20 kV: 30 kV
18/30 kV: 45 kV

Temperature range
During installation: -5 °C to +50 °C
Fixed installation: -40 °C to +90 °C

Article number	Number of cores and mm ² per conductor	Outer diameter [mm]	Copper index (kg/km)	Weight (kg/km)
6/10 kV				
3037523	1X35 RM/16	24.0	518	867
3022192	1X50 RM/16	25.0	662	1001
38007455	1X70 RM/16	26.0	854	1232
3037524	1X95 RM/16	28.0	1094	1500
38101056	1X120 RM/16	30.0	1334	1746
1550537	1X150 RM/25	31.0	1723	2095
38007456	1X185 RM/25	33.0	2059	2472
1550538	1X240 RM/25	35.0	2587	3032
38100269	1X300 RM/25	37.0	3163	3637
38101815	1X400 RM/35	40.0	4234	4535
38101814	1X500 RM/35	43.0	5194	5566
38107775	1x630 RM/35	47.0	6442	6935
12/20 kV				
1552067	1X35 RM/16	28.0	518	1030
1552040	1X50 RM/16	29.0	662	1169
38300006	1X70 RM/16	31.0	854	1410
3801425	1X95 RM/16	32.0	1094	1689
38100617	1X120 RM/16	34.0	1334	1944
1550554	1X150 RM/25	35.0	1723	2301
38107776	1x185 RM/25	37.0	2059	2689
38300015	1X240 RM/25	39.0	2587	3262
38300017	1X300 RM/25	42.0	3163	3882
38101817	1X400 RM/35	44.0	4234	4797
38101816	1X500 RM/35	47.0	5194	5850
38107777	1x630 RM/35	51.0	6442	7237
38107778	1x800 RM/35	56.0	8074	9058
18/30 kV				
38107779	1x35 RM/16	24.0	518	770
38300014	1X50 RM/16	34.0	662	1403
38107780	1x70 RM/16	36.0	854	1656
38801995	1X95 RM/16	37.0	1094	1947
38300009	1X120 RM/16	39.0	1334	2213
38107781	1x150 RM/25	40.0	1723	2580
38107782	1x185 RM/25	42.0	2059	2980
38106711	1X240 RM/25	44.0	2587	3570
38107783	1x300 RM/25	47.0	3163	4208
38107784	1x400 RM/35	50.0	4234	5147
38107785	1x500 RM/35	53.0	5194	6244

Unless specified otherwise, the shown product values are nominal values. Detailed values (e.g. tolerances) are available upon request.
Aluminium price basis: excludes aluminium. Refer to catalogue appendix T17 for the application and definition of „Metal price basis“ and „Metal index“.
Please find our standard lengths at: www.lappkabel.de/en/cable-standardlengths
Photographs and graphics are not to scale and do not represent detailed images of the respective products.



N2XS2Y

PE medium voltage cable with copper conductor

i Info

- 3 voltage classes: 6/10 kV, 12/20 kV, 18/30 kV
- With copper conductor



Application range

- Power and control cable for fixed installation in the following applications:
- In water, in ground, outdoors and indoors
- In cable trays for power stations, industry, and distribution networks
- Burial without additional, suitable underground protection according to HD 620/VDE 0276-620 - Part 10-C (point 4): normal minimum installation depth 0.6 m, but at least 0.8 m under roads

Product features

- Suitable for installation or operation under high mechanical stress due to the PE-sheath
- Current rating according to HD 620/VDE 0276-620, Part 10-C, Table 7 (buried at +20 °C ground temperature according to HD 620/VDE 0276-620, Part 10-C, point 5) for routing underground and Table 8 (in the air at an air temperature of +30 °C according to HD 620/

VDE 0276-620, Part 10-C, point 5) when used outdoors; but always taking into consideration corrections/reductions to the current rating that may be necessary according to VDE 0298-4, and VDE 0298-4 (also refer to the catalogue appendix T12) for installation in and on buildings

Norm references / Approvals

- HD 620/ VDE 0276-620

Product Make-up

- Copper conductor
- Abbreviation „rm“: r = round conductor form; m = multi-wire conductor
- Core insulation: Cross-linked Polyethylen (XLPE)
- Screen made of copper wires with one or two copper bond counter spiral
- Outer sheath: PE, black

Technical data

Classification ETIM 5/6
 ETIM 5.0/6.0 Class-ID: EC001140
 ETIM 5.0/6.0 Class-Description: Medium voltage power cable

Conductor stranding
 Multi-wire

Minimum bending radius
 Fixed installation: 15 x outer diameter

Nominal voltage
 U₀/U: 6/10 kV, 12/20 kV, 18/30 kV

Test voltage
 Depending on nominal voltage:
 6/10 kV: 15 kV
 12/20 kV: 30 kV
 18/30 kV: 45 kV

Temperature range
 During installation: -20 °C to +50 °C
 Fixed installation: -40 °C to +90 °C

Article number	Number of cores and mm ² per conductor	Outer diameter [mm]	Copper index (kg/km)	Weight (kg/km)
6/10 kV				
38107786	1x35 RM/16	24.0	518	770
38001000	1X50 RM/16	25.0	662	900
1552070	1X70 RM/16	26.0	854	1123
38107787	1x70 RM/50	27.0	1238	1450
38107788	1x95 RM/16	28.0	1094	1384
38107789	1x120 RM/16	30.0	1334	1623
38107029	1X150 RM/25	31.0	1723	1966
38107790	1x185 RM/25	33.0	2059	2335
1550067	1X240 RM/25	35.0	2587	2885
38107791	1x300 RM/25	37.0	3163	3480
38107792	1x400 RM/35	41.0	4234	4381
38107793	1x500 RM/35	43.0	5194	5382
12/20 kV				
1552068	1X35 RM/16	28.0	518	914
1552069	1X50 RM/16	29.0	662	1049
1552041	1X70 RM/16	31.0	854	1289
3828017	1X95 RM/16	32.0	1094	1554
38107794	1x120 RM/16	34.0	1334	1802
1552047	1X150 RM/25	35.0	1723	2153
38107795	1x185 RM/25	37.0	2059	2533
38107796	1x240 RM/25	39.0	2587	3096
38107797	1x300 RM/25	42.0	3163	3705
38107798	1x300 RM/35	42.0	3274	3800
38107799	1x400 RM/35	44.0	4234	4519
38107800	1x500 RM/35	47.0	5194	5647
38107801	1x630 RM/35	51.0	6442	7049
18/30 kV				
3036224	1X50 RM/16	34.0	662	1260
38107802	1x70 RM/16	36.0	854	1656
38107803	1x95 RM/16	37.0	1094	1789
38107804	1x120 RM/16	39.0	1334	2048
38107805	1x150 RM/25	40.0	1723	2409
3028167	1X185 RM/25	42.0	2059	2802
38107806	1x240 RM/25	44.0	2587	3382
38107807	1x300 RM/25	47.0	3163	4009
38107808	1x400 RM/35	50.0	4234	4934
38107809	1x500 RM/35	53.0	5194	6009
38107810	1x630 RM/35	56.0	6442	7423

Unless specified otherwise, the shown product values are nominal values. Detailed values (e.g. tolerances) are available upon request.
 Aluminium price basis: excludes aluminium. Refer to catalogue appendix T17 for the application and definition of „Metal price basis“ and „Metal index“.
 Please find our standard lengths at: www.lappkabel.de/en/cable-standardlengths
 Photographs and graphics are not to scale and do not represent detailed images of the respective products.



N2XS(F)2Y

Longitudinally water-tight PE medium voltage cable with copper conductor



Info

- 3 voltage classes: 6/10 kV, 12/20 kV, 18/30 kV
- With copper conductor

Technical data

- Classification ETIM 5/6**
ETIM 5.0/6.0 Class-ID: EC001140
ETIM 5.0/6.0 Class-Description: Medium voltage power cable
- Conductor stranding**
Multi-wire
- Minimum bending radius**
Fixed installation: 15 x outer diameter
- Nominal voltage**
U₀/U: 6/10 kV, 12/20 kV, 18/30 kV
- Test voltage**
Depending on nominal voltage:
6/10 kV: 15 kV
12/20 kV: 30 kV
18/30 kV: 45 kV
- Temperature range**
During installation: -20°C to +50°C
Fixed installation: -40°C to +90°C

Application range

- Power and control cable for fixed installation in the following applications:
- In water, in ground, outdoors and indoors
- In cable trays for power stations, industry, and distribution networks
- Also suitable for applications where longitudinal water propagation inside the cable should be avoided.
- Burial without additional, suitable underground protection according to HD 620/VDE 0276-620 - Part 10-C (point 4): normal minimum installation depth 0.6 m, but at least 0.8 m under roads

VDE 0276-620, Part 10-C, point 5) when used outdoors; but always taking into consideration corrections/reductions to the current rating that may be necessary according to VDE 0298-4, and VDE 0298-4 (also refer to the catalogue appendix T12) for installation in and on buildings

Norm references / Approvals

- HD 620/ VDE 0276-620

Product Make-up

- Copper conductor
- Abbreviation „rm“:
r = round conductor form;
m = multi-wire conductor
- Core insulation: Cross-linked Polyethylen (XLPE)
- Screen made of copper wires with one or two copper bond counter spiral
- Longitudinally water-tight wrapping
- Outer sheath: PE, black

Product features

- Suitable for installation or operation under high mechanical stress due to the PE-sheath
- Current rating according to HD 620/ VDE 0276-620, Part 10-C, Table 7 (buried at +20 °C ground temperature according to HD 620/VDE 0276-620, Part 10-C, point 5) for routing underground and Table 8 (in the air at an air temperature of +30 °C according to HD 620/

Article number	Number of cores and mm ² per conductor	Outer diameter [mm]	Copper index (kg/km)	Weight (kg/km)
6/10 kV				
38107811	1x35 RM/16	24.0	518	770
38107812	1x50 RM/16	25.0	662	900
38106992	1X70 RM/16	26.0	854	1124
3029947	1X95 RM/16	28.0	1094	1385
38105277	1X120 RM/16	30.0	1334	1624
1552073	1X150 RM/25	31.0	1723	1967
38103192	1X185 RM/25	33.0	2059	2336
30013473	1X240 RM/25	35.0	2587	2886
38107813	1x300 RM/25	37.0	3163	3481
38107814	1x400 RM/35	40.0	4234	4383
38107815	1x500 RM/35	43.0	5194	5384
38107816	1x630 RM/35	47.0	6442	6738
12/20 kV				
38801817	1X35 RM/16	28.0	518	914
38107817	1x50 RM/16	29.0	662	1050
32700792	1X70 RM/16	31.0	854	1290
30013472	1X95 RM/16	32.0	1094	1555
38802324	1X120 RM/16	34.0	1334	1803
1552043	1X150 RM/25	35.0	1723	2155
38107818	1x185 RM/25	37.0	2059	2534
32703444	1X240 RM/25	39.0	2587	3098
38107819	1x300 RM/25	41.0	3163	3707
38107820	1x400 RM/35	44.0	4234	4610
1552048	1X500 RM/35	47.0	5194	5649
1552042	1X630 RM/35	51.0	6442	7051
18/30 kV				
38107821	1x50 RM/16	34.0	662	1261
38107822	1x70 RM/16	36.0	854	1507
38107823	1x95 RM/16	37.0	1094	1790
38107824	1x120 RM/16	39.0	1334	2050
1552044	1X150 RM/25	40.0	1723	2411
1550992	1X185 RM/25	42.0	2059	2803
38106652	1X240 RM/25	44.0	2587	3384
38107825	1x300 RM/25	46.0	3163	4011
38107826	1x400 RM/35	49.0	4234	4937
38104163	1X500 RM/35	53.0	5194	6012
38107827	1x630 RM/35	56.0	6442	7425
38107828	1x800 RM/35	61.0	8074	9226

Unless specified otherwise, the shown product values are nominal values. Detailed values (e.g. tolerances) are available upon request.

Aluminium price basis: excludes aluminium. Refer to catalogue appendix T17 for the application and definition of „Metal price basis“ and „Metal index“.

Please find our standard lengths at: www.lappkabel.de/en/cable-standardlengths

Photographs and graphics are not to scale and do not represent detailed images of the respective products.



N2XS(FL)2Y

Longitudinally and transversely water-tight PE medium voltage cable with copper conductor

i Info

- 3 voltage classes: 6/10 kV, 12/20 kV, 18/30 kV
- With copper conductor



Application range

- Power and control cable for fixed installation in the following applications:
- In water, in ground, outdoors and indoors
- In cable trays for power stations, industry, and distribution networks
- Also suitable for applications where longitudinal and transversal water propagation inside the cable should be avoided.
- Burial without additional, suitable underground protection according to HD 620/VDE 0276-620 - Part 10-C (point 4): normal minimum installation depth 0.6 m, but at least 0.8 m under roads

Product features

- Suitable for installation or operation under high mechanical stress due to the PE-sheath
- Current rating according to HD 620/VDE 0276-620, Part 10-C, Table 7 (buried at +20 °C ground temperature according to HD 620/VDE 0276-620, Part 10-C, point 5) for routing underground and Table 8 (in the air at an air temperature of +30 °C according to HD 620/

VDE 0276-620, Part 10-C, point 5) when used outdoors; but always taking into consideration corrections/reductions to the current rating that may be necessary according to VDE 0298-4, and VDE 0298-4 (also refer to the catalogue appendix T12) for installation in and on buildings

Norm references / Approvals

- HD 620/ VDE 0276-620

Product Make-up

- Copper conductor
- Abbreviation „rm“: r = round conductor form; m = multi-wire conductor
- Core insulation: Cross-linked Polyethylen (XLPE)
- Screen made of copper wires with one or two copper bond counter spiral
- Longitudinally water-tight wrapping
- Metal tape firmly connected with PE sheath
- Outer sheath: PE, black

Technical data

- Classification ETIM 5/6**
ETIM 5.0/6.0 Class-ID: EC001140
ETIM 5.0/6.0 Class-Description: Medium voltage power cable
- Conductor stranding**
Multi-wire
- Minimum bending radius**
Fixed installation: 15 x outer diameter
- Nominal voltage**
U₀/U: 6/10 kV, 12/20 kV, 18/30 kV
- Test voltage**
Depending on nominal voltage:
6/10 kV: 15 kV
12/20 kV: 30 kV
18/30 kV: 45 kV
- Temperature range**
During installation: -20°C to +50°C
Fixed installation: -40°C to +90°C

Article number	Number of cores and mm ² per conductor	Outer diameter [mm]	Copper index (kg/km)	Weight (kg/km)
6/10 kV				
38107829	1x35 RM/16	25.0	518	813
38107830	1x50 RM/16	26.0	662	944
38107831	1x70 RM/16	27.0	854	1170
38107832	1x95 RM/16	29.0	1094	1434
38107833	1x120 RM/16	31.0	1334	1675
38107834	1x150 RM/25	32.0	1723	2020
38107835	1x185 RM/25	34.0	2059	2391
38106510	1X240 RM/25	36.0	2587	2945
38107836	1x300 RM/25	38.0	3163	3543
38107837	1x400 RM/35	41.0	4234	4450
38107838	1x500 RM/35	44.0	5194	5455
38107839	1x630 RM/35	48.0	6442	6814
12/20 kV				
38107840	1x35 RM/16	29.0	518	963
38107841	1x50 RM/16	30.0	662	1100
38107842	1x70 RM/16	32.0	854	1336
38107843	1x95 RM/16	33.0	1094	1609
38107844	1x120 RM/16	35.0	1334	1860
1550991	1X150 RM/25	36.0	1723	2213
38107845	1x185 RM/25	38.0	2059	2595
38107846	1x240 RM/25	40.0	2587	3163
38107847	1x300 RM/25	42.0	3163	3776
38107848	1x400 RM/35	45.0	4234	4682
38107849	1x500 RM/35	48.0	5194	5726
38107850	1x630 RM/35	52.0	6442	7103
18/30 kV				
38107851	1x95 RM/16	38.0	1094	1852
38107852	1x150 RM/25	41.0	1723	2478
38107853	1x300 RM/25	47.0	3163	4087
38107854	1x400 RM/35	50.0	4234	5016

Unless specified otherwise, the shown product values are nominal values. Detailed values (e.g. tolerances) are available upon request.
Aluminium price basis: excludes aluminium. Refer to catalogue appendix T17 for the application and definition of „Metal price basis“ and „Metal index“.
Please find our standard lengths at: www.lappkabel.de/en/cable-standardlengths
Photographs and graphics are not to scale and do not represent detailed images of the respective products.



NA2XSY

PVC medium voltage cable with aluminium conductor



Info

- 3 voltage classes: 6 / 10 kV, 12 / 20 kV, 18 / 30 kV
- With aluminium conductor

Application range

- Power and control cable for fixed installation in the following applications:
- In water, in ground, outdoors and indoors
- In cable trays for power stations, industry, and distribution networks
- Burial without additional, suitable underground protection according to HD 620/VDE 0276-620 - Part 10-C (point 4): normal minimum installation depth 0.6 m, but at least 0.8 m under roads

VDE 0276-620, Part 10-C, point 5) when used outdoors; but always taking into consideration corrections/reductions to the current rating that may be necessary according to VDE 0298-4, and VDE 0298-4 (also refer to the catalogue appendix T12) for installation in and on buildings

Norm references / Approvals

- HD 620/ VDE 0276-620

Product Make-up

- Aluminium conductor
- Abbreviation „rm“:
r = round conductor form;
m = multi-wire conductor
- Core insulation: Cross-linked Polyethylene (XLPE)
- Screen made of copper wires with one or two copper bond counter spiral
- Outer sheath: PVC, red

Technical data

- Classification ETIM 5/6**
ETIM 5.0/6.0 Class-ID: EC001140
ETIM 5.0/6.0 Class-Description: Medium voltage power cable
- Conductor stranding**
Multi-wire
- Minimum bending radius**
Fixed installation: 15 x outer diameter
- Nominal voltage**
U₀/U: 6 / 10 kV, 12 / 20 kV, 18 / 30 kV
- Test voltage**
Depending on nominal voltage:
6 / 10 kV: 15 kV
12 / 20 kV: 30 kV
18 / 30 kV: 45 kV
- Temperature range**
During installation: -5 °C to +50 °C
Fixed installation: -40 °C to +90 °C

Product features

- Flame-retardant according IEC 60332-1-2
- Current rating according to HD 620/ VDE 0276-620, Part 10-C, Table 7 (buried at +20 °C ground temperature according to HD 620/VDE 0276-620, Part 10-C, point 5) for routing underground and Table 8 (in the air at an air temperature of +30 °C according to HD 620/

Article number	Number of cores and mm ² per conductor	Copper index (kg/km)	Alu index (kg/km)	Outer diameter [mm]	Weight (kg/km)
6 / 10 kV					
38107855	1x50 RM / 16	182	145	25.0	719
38107856	1x70 RM / 16	182	203	26.0	810
38107857	1x70 RM / 35	394	203	27.0	1000
38107858	1x95 RM / 16	182	276	28.0	921
38107859	1x120 RM / 16	182	348	30.0	1022
38107860	1x150 RM / 25	283	435	31.0	1209
38107861	1x185 RM / 25	283	537	33.0	1351
38107862	1x240 RM / 25	283	696	35.0	1561
38107863	1x300 RM / 25	283	870	37.0	1771
3038844	1X400 RM / 35	394	1160	40.0	2184
38107864	1x500 RM / 35	394	1450	43.0	2517
12 / 20 kV					
38107865	1x50 RM / 16	182	145	29.0	889
38107866	1x70 RM / 16	182	203	31.0	988
38107867	1x95 RM / 16	182	276	32.0	1109
38107868	1x120 RM / 16	182	348	34.0	1220
38107869	1x150 RM / 25	283	435	35.0	1414
38802239	1X185 RM / 25	283	537	37.0	1567
38107870	1x240 RM / 25	283	696	39.0	1791
38107871	1x300 RM / 25	283	870	41.0	2014
38107872	1x400 RM / 35	394	1160	44.0	2412
38107873	1x500 RM / 35	394	1450	47.0	2798
18 / 30 kV					
38107874	1x50 RM / 16	182	145	34.0	1124
38107875	1x70 RM / 16	182	303	36.0	1234
38107876	1x70 RM / 25	283	203	36.0	1300
38107877	1x95 RM / 16	182	276	37.0	1367
38107878	1x120 RM / 16	182	348	39.0	1488
38107879	1x150 RM / 25	283	435	40.0	1692
38107880	1x185 RM / 25	283	537	42.0	1858
38107881	1x240 RM / 25	283	696	44.0	2099
38107882	1x300 RM / 25	283	870	46.0	2339
38107883	1x400 RM / 35	394	1160	49.0	2758
38107884	1x500 RM / 35	394	1450	52.0	3189
38107885	1x630 RM / 35	394	1827	56.0	3724

Unless specified otherwise, the shown product values are nominal values. Detailed values (e.g. tolerances) are available upon request.

Aluminium price basis: excludes aluminium. Refer to catalogue appendix T17 for the application and definition of „Metal price basis“ and „Metal index“.

Please find our standard lengths at: www.lappkabel.de/en/cable-standardlengths

Photographs and graphics are not to scale and do not represent detailed images of the respective products.

Accessories

- Cable lugs and other connectors made of aluminium or bi-metal Al-Cu are available upon request



NA2XS2Y

PE medium voltage cable with aluminium conductor

i Info

- 3 voltage classes: 6/10 kV, 12/20 kV, 18/30 kV
- With aluminium conductor



- Application range**
- Power and control cable for fixed installation in the following applications:
 - In water, in ground, outdoors and indoors
 - In cable trays for power stations, industry, and distribution networks
 - Burial without additional, suitable underground protection according to HD 620/VDE 0276-620 - Part 10-C (point 4): normal minimum installation depth 0.6 m, but at least 0.8 m under roads

VDE 0276-620, Part 10-C, point 5) when used outdoors; but always taking into consideration corrections/reductions to the current rating that may be necessary according to VDE 0298-4, and VDE 0298-4 (also refer to the catalogue appendix T12) for installation in and on buildings

- Norm references / Approvals**
- HD 620/ VDE 0276-620

- Product features**
- Suitable for installation or operation under high mechanical stress due to the PE-sheath
 - Current rating according to HD 620/ VDE 0276-620, Part 10-C, Table 7 (buried at +20 °C ground temperature according to HD 620/VDE 0276-620, Part 10-C, point 5) for routing underground and Table 8 (in the air at an air temperature of +30 °C according to HD 620/

- Product Make-up**
- Aluminium conductor
 - Abbreviation „rm“: r = round conductor form; m = multi-wire conductor
 - Core insulation: Cross-linked Polyethylen (XLPE)
 - Screen made of copper wires with one or two copper bond counter spiral
 - Outer sheath: PE, black

Technical data

- Classification ETIM 5/6**
ETIM 5.0/6.0 Class-ID: EC001140
ETIM 5.0/6.0 Class-Description: Medium voltage power cable
- Conductor stranding**
Multi-wire
- Minimum bending radius**
Fixed installation: 15 x outer diameter
- Nominal voltage**
U₀/U: 6/10 kV, 12/20 kV, 18/30 kV
- Test voltage**
Depending on nominal voltage:
6/10 kV: 15 kV
12/20 kV: 30 kV
18/30 kV: 45 kV
- Temperature range**
During installation: -20 °C to +50 °C
Fixed installation: -40 °C to +90 °C

Article number	Number of cores and mm ² per conductor	Copper index (kg/km)	Alu index (kg/km)	Outer diameter [mm]	Weight (kg/km)
6/10 kV					
38107886	1x50 RM/16	182	145	25.0	617
38107887	1x70 RM/16	182	203	26.0	701
38107888	1x95 RM/16	182	276	28.0	805
38107889	1x120 RM/16	182	348	30.0	900
32702886	1X150 RM/25	283	435	31.0	1081
38107890	1x185 RM/25	283	537	33.0	1215
32702885	1X240 RM/25	283	696	35.0	1414
38107891	1x300 RM/25	283	870	37.0	1614
38107892	1x400 RM/35	394	1160	41.0	2022
38105313	1X500 RM/35	394	1450	43.0	2367
38107893	1x630 RM/35	394	1827	47.0	2815
12/20 kV					
38107894	1x35 RM/16	182	102	28.0	700
32701312	1X50 RM/16	182	145	29.0	767
38107895	1x70 RM/16	182	203	31.0	860
38107896	1x70 RM/25	283	203	31.0	950
38000020	1X95 RM/16	182	276	32.0	974
1552075	1X120 RM/16	182	348	34.0	1078
30018695	1X150 RM/25	283	435	35.0	1267
38106595	1X185 RM/25	283	537	37.0	1412
38106519	1X240 RM/25	283	696	39.0	1625
38107897	1x300 RM/25	283	870	41.0	1839
3033789	1X400 RM/35	394	1160	44.0	2224
38107898	1x500 RM/35	394	1450	47.0	2597
1550993	1X630 RM/35	394	1827	50.0	3281
1552072	1X800 RM/35	394	2320	56.0	3983
18/30 kV					
38107899	1x50 RM/16	182	145	34.0	980
38107900	1x70 RM/16	182	303	36.0	1083
38107901	1x95 RM/16	182	276	37.0	1209
38107902	1x120 RM/16	182	348	39.0	1324
38107903	1x150 RM/25	283	435	40.0	1522
38107904	1x185 RM/25	283	537	42.0	1680
38107905	1x240 RM/25	283	696	44.0	1910
38107906	1x300 RM/25	283	870	46.0	2141
38107907	1x400 RM/35	394	1160	49.0	2547
38107908	1x500 RM/35	394	1450	52.0	2956
38107909	1x630 RM/35	394	1827	56.0	3465

Unless specified otherwise, the shown product values are nominal values. Detailed values (e.g. tolerances) are available upon request.
 Aluminium price basis: excludes aluminium. Refer to catalogue appendix T17 for the application and definition of „Metal price basis“ and „Metal index“.
 Please find our standard lengths at: www.lappkabel.de/en/cable-standardlengths
 Photographs and graphics are not to scale and do not represent detailed images of the respective products.

- Accessories**
- Cable lugs and other connectors made of aluminium or bi-metal Al-Cu are available upon request



NA2XS(F)2Y

Longitudinally water-tight PE medium voltage cable with aluminium conductor



Info

- 3 voltage classes: 6/10 kV, 12/20 kV, 18/30 kV
- With aluminium conductor

Application range

- Power and control cable for fixed installation in the following applications:
- In water, in ground, outdoors and indoors
- In cable trays for power stations, industry, and distribution networks
- Also suitable for applications where longitudinal water propagation inside the cable should be avoided.
- Burial without additional, suitable underground protection according to HD 620/VDE 0276-620 - Part 10-C (point 4): normal minimum installation depth 0.6 m, but at least 0.8 m under roads

Product features

- Suitable for installation or operation under high mechanical stress due to the PE-sheath
- Current rating according to HD 620/VDE 0276-620, Part 10-C, Table 7 (buried at +20 °C ground temperature according to HD 620/VDE 0276-620, Part 10-C, point 5) for routing underground and Table 8 (in the air at an air temperature of +30 °C according to HD 620/

VDE 0276-620, Part 10-C, point 5) when used outdoors; but always taking into consideration corrections/reductions to the current rating that may be necessary according to VDE 0298-4, and VDE 0298-4 (also refer to the catalogue appendix T12) for installation in and on buildings

Norm references / Approvals

- HD 620 / VDE 0276-620

Product Make-up

- Aluminium conductor
- Abbreviation „rm“:
r = round conductor form;
m = multi-wire conductor
- Core insulation: Cross-linked Polyethylen (XLPE)
- Screen made of copper wires with one or two copper bond counter spiral
- Longitudinally water-tight wrapping
- Outer sheath: PE, black

Technical data

Classification ETIM 5/6
ETIM 5.0/6.0 Class-ID: EC001140
ETIM 5.0/6.0 Class-Description: Medium voltage power cable

Conductor stranding
Multi-wire

Minimum bending radius
Fixed installation: 15 x outer diameter

Nominal voltage
U₀/U: 6/10 kV, 12/20 kV, 18/30 kV

Test voltage
Depending on nominal voltage:
6/10 kV: 15 kV
12/20 kV: 30 kV
18/30 kV: 45 kV

Temperature range
During installation: -20°C to +50°C
Fixed installation: -40°C to +90°C

Article number	Number of cores and mm ² per conductor	Copper index (kg/km)	Alu index (kg/km)	Outer diameter [mm]	Weight (kg/km)
6/10 kV					
1552026	1 x 50 RM/16	182	145	25.0	617
38107610	1 x 70 RM/16	182	203	27.0	709
38107611	1 x 95 RM/16	182	276	28.0	805
38107612	1 x 120 RM/16	182	348	30.0	901
38801523	1 x 150 RM/25	283	435	31.0	1082
38106386	1 x 185 RM/25	283	537	33.0	1216
38801932	1 x 240 RM/25	283	696	35.0	1415
38802344	1 x 300 RM/25	283	870	37.0	1620
38107614	1 x 400 RM/35	394	1160	40.0	2024
38107615	1 x 400 RM/50	566	1160	40.0	2024
38107616	1 x 500 RM/35	394	1450	43.0	2369
38107617	1 x 630 RM/35	394	1827	47.0	2817
38107618	1 x 800 RM/35	394	2320	51.0	3381
38107619	1 x 1000 RM/35	394	2900	56.0	4100
12/20 kV					
38107620	1 x 50 RM/16	182	145	29.0	768
38000155	1 x 70 RM/16	182	203	31.0	868
38000184	1 x 95 RM/16	182	276	32.0	975
1552028	1 x 120 RM/16	182	348	34.0	1079
38107621	1 x 150 RM/16	182	435	35.0	1268
3037568	1 x 150 RM/25	283	435	35.0	1268
1552029	1 x 185 RM/25	283	537	37.0	1413
38801987	1 x 240 RM/25	283	696	39.0	626
38801756	1 x 300 RM/25	283	870	41.0	1845
38801724	1 x 400 RM/35	394	1160	44.0	2226
38801988	1 x 500 RM/35	394	1450	47.0	2599
38801986	1 x 630 RM/35	394	1827	51.0	3093
1552065	1 x 800 RM/35	394	2320	56.0	3727
38103208	1 x 1000 RM/35	394	2900	61.0	4450
18/30 kV					
38000116	1 x 50 RM/16	182	145	34.0	981
38107622	1 x 70 RM/16	182	203	36.0	1085
38000476	1 x 95 RM/16	182	276	37.0	1211
38107623	1 x 95 RM/35	394	396	37.0	1211
38106295	1 x 120 RM/16	182	348	39.0	1325
38105412	1 x 150 RM/25	283	435	40.0	1524
38106387	1 x 185 RM/25	283	537	42.0	1681
1552031	1 x 240 RM/25	283	696	44.0	1912
38105413	1 x 300 RM/25	283	870	46.0	2150
1552033	1 x 400 RM/35	394	1160	49.0	2550
1552045	1 x 500 RM/35	394	1450	52.0	2959
1552030	1 x 630 RM/35	394	1827	56.0	3498
38106514	1 x 800 RM/35	394	2320	61.0	4152

Unless specified otherwise, the shown product values are nominal values. Detailed values (e.g. tolerances) are available upon request.

Aluminium price basis: excludes aluminium. Refer to catalogue appendix T17 for the application and definition of „Metal price basis“ and „Metal index“.

Please find our standard lengths at: www.lappkabel.de/en/cable-standardlengths / Photographs and graphics are not to scale and do not represent detailed images of the respective products.



NA2XS(FL)2Y

Longitudinally and transversely water-tight PE medium voltage cable with aluminium conductor

Info

- 3 voltage classes: 6/10 kV, 12/20 kV, 18/30 kV
- With aluminium conductor



Application range

- Power and control cable for fixed installation in the following applications:
- In water, in ground, outdoors and indoors
- In cable trays for power stations, industry, and distribution networks
- Also suitable for applications where longitudinal and transversal water propagation inside the cable should be avoided.
- Burial without additional, suitable underground protection according to HD 620/VDE 0276-620 - Part 10-C (point 4): normal minimum installation depth 0.6 m, but at least 0.8 m under roads

Product features

- Suitable for installation or operation under high mechanical stress due to the PE-sheath
- Current rating according to HD 620/VDE 0276-620, Part 10-C, Table 7 (buried at +20 °C ground temperature according to HD 620/VDE 0276-620, Part 10-C, point 5) for routing underground and Table 8 (in the air at an air temperature of +30 °C according to HD 620/

VDE 0276-620, Part 10-C, point 5) when used outdoors; but always taking into consideration corrections/reductions to the current rating that may be necessary according to VDE 0298-4, and VDE 0298-4 (also refer to the catalogue appendix T12) for installation in and on buildings

Norm references / Approvals

- HD 620/ VDE 0276-620

Product Make-up

- Aluminium conductor
- Abbreviation „rm“: r = round conductor form; m = multi-wire conductor
- Core insulation: Cross-linked Polyethylen (XLPE)
- Screen made of copper wires with one or two copper bond counter spiral
- Longitudinally water-tight wrapping
- Metal tape firmly connected with PE sheath
- Outer sheath: PE, black

Technical data

- Classification ETIM 5/6**
 ETIM 5.0/6.0 Class-ID: EC001140
 ETIM 5.0/6.0 Class-Description: Medium voltage power cable
- Conductor stranding**
 Multi-wire
- Minimum bending radius**
 Fixed installation: 15 x outer diameter
- Nominal voltage**
 U_0/U : 6/10 kV, 12/20 kV, 18/30 kV
- Test voltage**
 Depending on nominal voltage:
 6/10 kV: 15 kV
 12/20 kV: 30 kV
 18/30 kV: 45 kV
- Temperature range**
 During installation: -20 °C to +50 °C
 Fixed installation: -40 °C to +90 °C

Article number	Number of cores and mm ² per conductor	Copper index (kg/km)	Alu index (kg/km)	Outer diameter [mm]	Weight (kg/km)
6/10 kV					
38107624	1 x 120 RM/16	182	348	31.0	951
38107625	1 x 150 RM/25	283	435	32.0	1134
38107626	1 x 240 RM/25	283	696	36.0	1473
38107627	1 x 400 RM/35	394	1160	41.0	2091
12/20 kV					
38107628	1 x 70 RM/16	182	203	32.0	914
38107629	1 x 70 RM/25	283	203	32.0	1015
38107630	1 x 95 RM/25	283	276	34.0	1100
38107631	1 x 120 RM/16	182	348	35.0	1136
38106494	1 x 150 RM/25	283	435	36.0	1327
38107252	1 x 185 RM/25	283	537	38.0	1474
38107253	1 x 240 RM/25	283	696	40.0	1691
38107632	1 x 300 RM/25	283	870	42.0	1914
38106656	1 x 400 RM/35	394	1160	45.0	2298
38107633	1 x 500 RM/35	394	1450	48.0	2675
18/30 kV					
38107634	1 x 70 RM/16	182	203	37.0	1144
38107635	1 x 95 RM/16	182	276	38.0	1273
38107636	1 x 120 RM/16	182	348	40.0	1389
38107637	1 x 150 RM/25	283	435	41.0	1590
38106590	1 x 185 RM/25	283	537	43.0	1750
38107638	1 x 240 RM/25	283	696	45.0	1984
38107639	1 x 300 RM/25	283	870	48.0	2225
38107640	1 x 400 RM/35	394	1160	50.0	2629
38107641	1 x 500 RM/35	394	1450	53.0	3042

Unless specified otherwise, the shown product values are nominal values. Detailed values (e.g. tolerances) are available upon request.
 Aluminium price basis: excludes aluminium. Refer to catalogue appendix T17 for the application and definition of „Metal price basis“ and „Metal index“.
 Please find our standard lengths at: www.lappkabel.de/en/cable-standardlengths
 Photographs and graphics are not to scale and do not represent detailed images of the respective products.

Accessories

- Cable lugs and other connectors made of aluminium or bi-metal Al-Cu are available upon request



ETHERLINE® T1 FLEX

Flexible use



Info

- Single Pair Ethernet
- Industrial Ethernet at the Edge
- High mechanical and chemical resistance

Benefits

- Up to 100 Mbit/s with only one twisted pair
- Industrial Ethernet up to the sensor/ actuator in the field level of Automation
- Lean and flexible cable construction

Application range

- 10/ 100 Mbit/s for Industrial Ethernet
- One Pair Ethernet
- For flexible applications (7-wire stranded conductor)
- Industrial use

Product features

- Halogen-free according to VDE 0472-815
- Oil-resistant according to EN 60811-404
- Flammability:
IEC/EN: 60332-1-2
UL/CSA: Horizontal Flame, FT2

Norm references / Approvals

- IEEE 802.3bw: 100BASE-T1
- IEEE 802.3cg: 10BASE-T1
- UL-AWM-Style 21198 (80 °C / 300 V)

Product Make-up

- 7-wire bare stranded copper conductor
- Core insulation: Based on Polyolefin
- Screening: wrapped with braided tinned-copper wires
- Outer sheath: PUR, violet (RAL 4001)

Technical data

Classification ETIM 5/6
ETIM 5.0/6.0 Class-ID: EC000830
ETIM 5.0/6.0 Class-Description: Data cable

Peak operating voltage
(not for power applications) 125 V

Minimum bending radius
Flexing: 15 x outer diameter
Fixed installation: 8 x outer diameter

Test voltage
C/C: 2000 V
C/S: 2000 V

Characteristic impedance
nom. 100 Ω

Temperature range
Fixed installation: -40 °C to +80 °C
Flexing: -30 °C to +70 °C

Article number	Article designation	Number of pairs and AWG per conductor	Outer diameter mm	Core diameter in mm	Weight (kg/km)
ETHERLINE® T1 FLEX					
2170924	ETHERLINE® T1 P FLEX 1x2xAWG18/7	2 x 1 x AWG18/7	8.0	2.55	61
2170921	ETHERLINE® T1 P FLEX 1x2xAWG26/7	2 x 1 x AWG26/7	4.7	1.1	25

Unless specified otherwise, the shown product values are nominal values. Detailed values (e.g. tolerances) are available upon request.

Copper price basis: EUR 150/100 kg. Refer to catalogue appendix T17 for the definition and calculation of copper-related surcharges.

Please find our standard lengths at: www.lappkabel.de/en/cable-standardlengths

Detailed data sheets are available upon request. Please specify the type/dimensions of the required cable.

Photographs and graphics are not to scale and do not represent detailed images of the respective products.



ETHERLINE® FIRE

Industrial Ethernet cable with insulation integrity

i Info

- Insulation integrity for at least 120 minutes in the event of fire

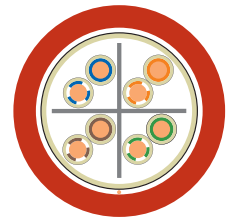

Benefits

- Ensures that the cable can still transmit data during and after a fire for 120 min (according to EN50200)
- High-quality, double screening ensures high transmission reliability in areas with electromagnetic interference

Application range

- In industrial areas that use fire as a tool
- Highly combustible or fire-prone areas
- For fixed installation
- For indoor use

Product features

- Fire behaviour:
 - Halogen-free (IEC 60754-1 & EN50267-2-1)
 - Flame-retardant (IEC 60332-1)
 - Fire retardant (IEC 60332-3-24)
 - Low smoke density (IEC 61034-2)
 - Circuit integrity (EN50200); 120 min

Product Make-up

- Solid bare copper conductor
- Core insulation: Based on Polyolefin
- Each insulation will be wrapped with a special tape (anti-fire barrier)
- Twisting: 2 twisted-pair cores, stranding from 4 pairs
- Halogen-free and flame-retardant FRNC outer sheath, colour: red (similar to RAL3000)

Technical data

- Classification ETIM 5/6**
ETIM 5.0/6.0 Class-ID: EC000830
ETIM 5.0/6.0 Class-Description: Data cable
- Peak operating voltage**
(not for power applications) 125 V
- Minimum bending radius**
Fixed installation: 15 x outer diameter
- Characteristic impedance**
nom. 100 Ω acc. to IEC 61156-5
- Temperature range**
Operation: -20 °C to +70 °C

Article number	Article designation	Number of pairs and AWG per conductor	Outer diameter mm	Core diameter in mm	Copper index (kg/km)	Weight (kg/km)
ETHERLINE® FIRE						
2170905	ETHERLINE® FIRE Cat.5e PH120	4 x 2 x AWG23/1	8.6	0.95	24	75
2170913	ETHERLINE® FIRE Cat.6 PH120	4 x 2 x AWG22/1	10.2	1.5	48	145

Unless specified otherwise, the shown product values are nominal values. Detailed values (e.g. tolerances) are available upon request. Copper price basis: EUR 150/100 kg. Refer to catalogue appendix T17 for the definition and calculation of copper-related surcharges. Detailed data sheets are available upon request. Please specify the type/dimensions of the required cable. Photographs and graphics are not to scale and do not represent detailed images of the respective products.



ETHERLINE® ACCESS NF



Benefits

- Compact design with high port density
- Reduced installation effort in existing networks
- Easy Configuration via web-interface
- Space saving and industrial grade DIN rail mounting

Application range

- Industrial networks

Product features

- NAT (Basic NAT, NAPT) and port forwarding
- Integrated Firewall feature
- RJ45 Ports: 10/100BaseT(X)

Norm references / Approvals

- UL 61010

Info

- Compact design
- Tailor-made solution

Technical data

Classification ETIM 5/6
 ETIM 5.0/6.0 Class-ID: EC000734
 ETIM 5.0/6.0 Class-Description:
 Network switch

power supply
 DC 24 V (18-30 V DC)

Protection rating
 IP20

Temperature range
 -40°C up to +75°C

Article number	Article designation	Type	number of ports	Product features	MTBF in years
ETHERLINE® ACCESS NF					
21700141	ETHERLINE ACCESS NF04T	Managed	4 x RJ45	NAT	>14,01

Photographs and graphics are not to scale and do not represent detailed images of the respective products.



ETHERLINE® ACCESS PNF



Benefits

- Compact design with high port density
- Easy Configuration via web-interface
- Space saving and industrial grade DIN rail mounting

Application range

- Industrial application
- PROFINET® - networks

Product features

- PROFINET® switches with 5, 8 and 16 ports
- PROFINET® Conformance Class B
- Prioritization of PROFINET® telegrams
- Neighbourhood detection LLDP
- RJ45 Ports: 10/100BaseT(X)

Norm references / Approvals

- UL 61010

Info

- Compact design
- Compatible for PROFINET® networks

Technical data

Classification ETIM 5/6
 ETIM 5.0/6.0 Class-ID: EC000734
 ETIM 5.0/6.0 Class-Description:
 Network switch

power supply
 DC 24 V (18-30 V DC)

Protection rating
 IP20

Temperature range
 -40°C up to +75°C

Article number	Article designation	Type	number of ports	Product features	MTBF in years
ETHERLINE® ACCESS PNF					
21700140	ETHERLINE ACCESS PNF04T	Managed	4 x RJ45	for Profinet	>15,21
21700142	ETHERLINE ACCESS PNF08T	Managed	8 x RJ45	for Profinet	>13,09
21700143	ETHERLINE ACCESS PNF16T	Managed	16 x RJ45	for Profinet	>9,64

Photographs and graphics are not to scale and do not represent detailed images of the respective products.



ETHERLINE® ACCESS UF

i Info

- Compact design



Benefits

- Compact design with high port density
- PROFINET® enabled device
- Space saving and industrial grade DIN rail mounting

Application range

- Industrial networks

Product features

- Switches with 5, 8 and 16 ports
- RJ45 Ports: 10/100BaseT(X)

Norm references / Approvals

- UL 61010

Technical data

- Classification ETIM 5/6**
ETIM 5.0/6.0 Class-ID: EC000734
ETIM 5.0/6.0 Class-Description: Network switch
- power supply**
DC 24 V (18-30 V DC)
- Protection rating**
IP20
- Temperature range**
-25°C to +60°C

Article number	Article designation	Type	number of ports	MTBF in years
ETHERLINE® ACCESS UF				
21700144	ETHERLINE ACCESS UF05T	Unmanaged	5 x RJ45	>35,55
21700145	ETHERLINE ACCESS UF08T	Unmanaged	8 x RJ45	>29,70
21700146	ETHERLINE ACCESS UF16T	Unmanaged	16 x RJ45	>16,62

Photographs and graphics are not to scale and do not represent detailed images of the respective products.



ETHERLINE® ACCESS U

Industrial unmanaged Ethernet switches



Info

- Redundant power inputs
- Robust metal housing and DIN rail mounting
- Fanless maintenance free

Benefits

- Improve your total cost of ownership with faster installation and lower downtime
- Most flexible and globally present solutions from one hand

Product features

- RJ45 Ports: 10/100BaseT(X)
- Packet Buffer Size: 512 kbit
- Broadcast storm protection
- Redundant Power Input: 24 VDC

Norm references / Approvals

- UL 61010
- Shock IEC 60068-2-27
- Freefall IEC60068-2-32
- Vibration IEC 60068-2-6

Technical data

Classification ETIM 5/6
 ETIM 5.0/6.0 Class-ID: EC000734
 ETIM 5.0/6.0 Class-Description:
 Network switch

power supply
 DC 24 V (18-30 V DC)

Protection rating
 IP 30

Temperature range
 -10°C to +60°C

Article number	Article designation	Type	number of ports	Product features
Unmanaged switches with RJ45				
21700123	ETHERLINE ACCESS U05T-2GEN	Unmanaged	5 x RJ45	
21700124	ETHERLINE ACCESS U08T-2GEN	Unmanaged	8 x RJ45	
21700120	ETHERLINE ACCESS U16T	Unmanaged	16 x RJ45	
Gigabit Unmanaged switches				
21700129	ETHERLINE ACCESS U08GT	Unmanaged	8 x RJ45	Gigabit
PoE Unmanaged Switches				
21700138	ETHERLINE ACCESS U04TP01T	Unmanaged	5 x RJ45	PoE

Photographs and graphics are not to scale and do not represent detailed images of the respective products.

Accessories

- ETHERLINE® EC FD Cat.5e RJ45 refer to main catalogue 2020/21



ETHERLINE® ACCESS M
Industrial managed Ethernet switches

i Info

- Redundant power inputs
- Robust metal housing and DIN rail mounting
- Fanless maintenance free



Benefits

- Improve your total cost of ownership with faster installation and lower downtime
- Most flexible and globally present solutions from one hand

Product features

- Simple setup of redundant networktopologies with reconfiguration time < 20 ms
- RJ45 Ports: 10/100BaseT(X)
- Packet Buffer Size: 1 Mbit
- Supported protocols: HTTP, Telnet, EtherNet/IP, Modbus/TCP, IPv6, and many more
- Redundant Power Input: 24 VDC

Norm references / Approvals

- UL 61010
- Shock IEC 60068-2-27
- Freefall IEC60068-2-32
- Vibration IEC 60068-2-6

Technical data

Classification ETIM 5/6
ETIM 5.0/6.0 Class-ID: EC000734
ETIM 5.0/6.0 Class-Description:
Network switch

power supply
DC 24 V (18-30 V DC)

Protection rating
IP 40

Temperature range
-40°C up to +75°C

Article number	Article designation	Type	number of ports	Product features
Managed Switches with RJ45				
21700125	ETHERLINE ACCESS M06T-2GEN	Managed	6 x RJ45	
21700126	ETHERLINE ACCESS M08T-2GEN	Managed	8 x RJ45	
Managed Switches with SFP				
21700136	ETHERLINE ACCESS M08T02SFP	Managed	8 x RJ45 + 2 x SFP	SFP Port
21700137	ETHERLINE ACCESS M08T02GSFP	Managed	8 x RJ45 + 2 x SFP Gbit/s	SFP Port

Photographs and graphics are not to scale and do not represent detailed images of the respective products.

Accessories

- ETHERLINE® EC FD Cat.5e RJ45 refer to main catalogue 2020/21



HITRONIC® SBX

Industrial splice boxes for splicing fibre optic cables



Product features

- SC-RJ variants are suitable for PROFINET® applications
- Mounting type on contract rail: TH35
- Three different cable inlets and positions on contract rail possible
- Available in 6x and 12x duplex adapter
- Plastic or metal version



Info

- For different connector types in singlemode und multimode versions

Article number	Article designation	Housing material	Colour	PU
Multimode G50 OM4				
29500792	HITRONIC SBX 12xST-D MT PG150 G50 OM4	metal		1 piece
29500796	HITRONIC SBX 12xSC-D VT PG150 G50 OM4	plastic	violet	1 piece
29500805	HITRONIC SBX 12xLC-D VT PG150 G50 OM4	plastic	violet	1 piece
29500777	HITRONIC SBX 6xST-D MT PG150 G50 OM4	metal		1 piece
29500782	HITRONIC SBX 6xSC-D VT PG150 G50 OM4	plastic	violet	1 piece
29500788	HITRONIC SBX 6XSC-RJ BG PG150 G50 OM4	plastic	beige	1 piece
29500801	HITRONIC SBX 6xLC-D VT PG150 G50 OM4	plastic	violet	1 piece
Multimode G50 OM3				
29500791	HITRONIC SBX 12xST-D MT PG150 G50 OM3	metal		1 piece
29500795	HITRONIC SBX 12xSC-D TQ PG150 G50 OM3	plastic	turquoise	1 piece
29500804	HITRONIC SBX 12xLC-D TQ PG150 G50 OM3	plastic	turquoise	1 piece
29500776	HITRONIC SBX 6xST-D MT PG150 G50 OM3	metal		1 piece
29500781	HITRONIC SBX 6xSC-D TQ PG150 G50 OM3	plastic	turquoise	1 piece
29500787	HITRONIC SBX 6XSC-RJ BG PG150 G50 OM3	plastic	beige	1 piece
29500800	HITRONIC SBX 6xLC-D TQ PG150 G50 OM3	plastic	turquoise	1 piece
Multimode G50 OM2				
29500790	HITRONIC SBX 12xST-D MT PG150 G50 OM2	metal		1 piece
29500794	HITRONIC SBX 12xSC-D BG PG150 G50 OM2	plastic	beige	1 piece
29500803	HITRONIC SBX 12xLC-D BG PG150 G50 OM2	plastic	beige	1 piece
29500775	HITRONIC SBX 6xST-D MT PG150 G50 OM2	metal		1 piece
29500780	HITRONIC SBX 6xSC-D BG PG150 G50 OM2	plastic	beige	1 piece
29500786	HITRONIC SBX 6XSC-RJ BG PG150 G50 OM2	plastic	beige	1 piece
29500799	HITRONIC SBX 6xLC-D BG PG150 G50 OM2	plastic	beige	1 piece
Multimode G62,5 OM1				
29500774	HITRONIC SBX 6xST-D MT PG150 G62.5 OM1	metal		1 piece
29500785	HITRONIC SBX 6XSC-RJ BG PG150 G62.5 OM1	plastic	beige	1 piece
29500798	HITRONIC SBX 6xLC-D BG PG150 G62.5 OM1	plastic	beige	1 piece
Singlemode E9/125 OS2				
29500793	HITRONIC SBX 12xST-D MT PG150 E9 OS2	metal		1 piece
29500797	HITRONIC SBX 12xSC-D BL PG150 E9 OS2	plastic	blue	1 piece
29500806	HITRONIC SBX 12xLC-D BL PG150 E9 OS2	plastic	blue	1 piece
29500778	HITRONIC SBX 6xST-D MT PG150 E9 OS2	metal		1 piece
29500783	HITRONIC SBX 6xSC-D BL PG150 E9 OS2	plastic	blue	1 piece
29500784	HITRONIC SBX 6xSC-D MT PG150 E9 OS2	metal		1 piece
29500789	HITRONIC SBX 6XSC-RJ BL PG150 E9 OS2	plastic	blue	1 piece
29500802	HITRONIC SBX 6xLC-D BL PG150 E9 OS2	plastic	blue	1 piece

Other types of connectors (e.g. LC, MTRJ, E2000) are available upon request. Judy Lim: This will not apply to Hitronic anymore, as LC will become a standard product and MTRJ/E2000 will be removed.

Photographs and graphics are not to scale and do not represent detailed images of the respective products.

EPIC® DATA TS
Din rail adapter for optical fibre

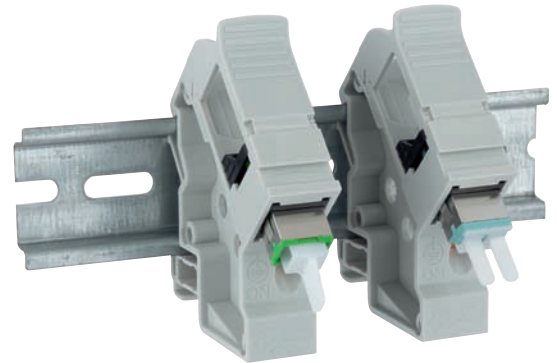

Info

- Mountable carrier

Product features

- Directly mountable on carrier acc. to DIN 50022 in industrial environment
- Available for breakout cables with clutch SC Simplex, SC-RJ and LC duplex
- Labeling for better identification
- Easy to install with screwdriver
- Suitable for GOF singlemode and multimode fibers
- Ideal for the industry due to its compact design
- Colour: grey (RAL 7035)
- Material housing: PC-GFIO
- Loading force ≥ 100 N
- Extraction force: ≥ 40 N

Technical data

 **Classification ETIM 5/6**
ETIM 5.0/6.0 Class-ID: EC001130
ETIM 5.0/6.0 Class-Description: Patch panel fibre optic

 **Protection rating**
IP 20

 **Temperature range**
-10 bis + 60°C (operation)

Article number	Article designation	PU
EPIC® DATA TS		
29500762	EPIC DATA TS GOF LC-D MM	1 piece
29500763	EPIC DATA TS GOF LC-D SM	1 piece
29500760	EPIC DATA TS GOF SC MM	1 piece
29500761	EPIC DATA TS GOF SC SM	1 piece
29500764	EPIC DATA TS GOF SC-RJ MM	1 piece
29500765	EPIC DATA TS GOF SC-RJ SM	1 piece

Photographs and graphics are not to scale and do not represent detailed images of the respective products.

Accessories

- GOF DUPLEX Patchcord refer to main catalogue 2020/21



EPIC® H-A 3 MTG

Innovative metal and plastic housing design



Info

- Small, rugged metal housing
- Integrated cable gland

EPIC® H-A 3 MTS

Innovative metal and plastic housing design



Info

- Small, rugged metal housing
- Integrated cable gland

Benefits

- Housing in plastic or metal version. For power supply in the smallest possible space

Application range

- Machine and equipment manufacturing
- Control engineering
- Electronic laboratory

Product features

- Hood
- Bolts for single lever
- Straight or side cable entry
- Versions with cable gland

Technical data

Classification ETIM 5/6
 ETIM 5.0/6.0 Class-ID: EC000437
 ETIM 5.0/6.0 Class-Description:
 Housing for industrial connectors

Material
EPIC® H-A 3 MTG
 Housing: powder-coated zinc die-casting, grey
 Lever: zinc-plated steel
EPIC® H-A 3 MTS
 Housing: powder-coated zinc die-casting, grey
 Lever: zinc-plated steel

IP **Protection rating**
 IP 65 (latched)
 NEMA 250 (latched)

DIN VDE **VDE-tested**
 Certified production control:
 VDE-REG. no.: B437
 UL-tested:
 UL File Number: E75770

Temperature range
 -40°C to +100°C,
 short-term up to +125°C

Article number	Article description	Material	Colour	Cable gland	Cable clamping range	Pieces / PU
H-A housing: hood (straight cable entry)						
19512102	H-A 3 MTGV 7-13	Zinc die-casting		yes	7.0 - 13.0	10
H-A housing: hood (side cable entry)						
10422507	H-A 3 MTSV 7-13	Zinc die-casting	grey	yes	7.0 - 13.0	10

Photographs and graphics are not to scale and do not represent detailed images of the respective products.



EPIC® H-A 3 MTGH
Innovative metal housing



i Info

- Small, rugged metal housing in high version

Benefits

- Housing for power supply in the smallest possible space

Application range

- Machine and equipment manufacturing
- Control engineering
- Electronic laboratory

Product features

- Hood, high version
- Bolts for single lever
- Straight cable entry
- Versions with / without cable gland

Technical data

<p>ETIM</p> <p>Classification ETIM 5/6 ETIM 5.0/6.0 Class-ID: EC000437 ETIM 5.0/6.0 Class-Description: Housing for industrial connectors</p>	<p>DIN VDE</p> <p>VDE-tested Certified production control: VDE-REG. no.: B437 UL-tested: UL File Number: E75770</p>
<p>Material</p> <p>Housing: powder-coated zinc die-casting, grey Lever: zinc-plated steel</p>	<p>Temperature range</p> <p>-40°C to +100°C, short-term up to +125°C</p>
<p>IP</p> <p>Protection rating IP 65 (latched) NEMA 250 (latched)</p>	

Article number	Article description	M	Cable gland	Cable clamping range	Material	Pieces / PU
EPIC® H-A 3 MTGH						
19512103	EPIC H-A 3 MTGH M25	25			Zinc die-casting	10
19512104	EPIC H-A 3 MTGHV 9-17		yes	9.0 - 17.0	Zinc die-casting	10

Photographs and graphics are not to scale and do not represent detailed images of the respective products.



EPIC® H-A 3 MEG

Innovative metal housing



Info

- Innovative screw mounted housing

Benefits

- Housing for power supply in the smallest possible space

Application range

- Machine and equipment manufacturing
- Control engineering
- Electronic laboratory

Product features

- Screw mounted housing
- 1 lever
- Screw mounted housing, flat gasket included

Technical data



Classification ETIM 5/6

ETIM 5.0/6.0 Class-ID: EC000437
ETIM 5.0/6.0 Class-Description:
Housing for industrial connectors



Material

Housing: powder-coated zinc die-casting, grey
Lever: zinc-plated steel
Sealing: NBR
Housing: grey thermoplastic, black
Lever: zinc-plated steel
Sealing: NBR



Protection rating

IP 65 (latched)
NEMA 250 (latched)



VDE-tested

Certified production control:
VDE-REG. no.: B437
UL-tested:
UL File Number: E75770



Temperature range

-40°C to +100°C,
short-term up to +125°C

Article number	Article description	Material	Pieces / PU
EPIC® H-A 3 MEG			
10422505	EPIC H-A 3 MEG	Zinc die-casting	10
10422506	EPIC H-A 3 MEGS	Zinc die-casting	10

Photographs and graphics are not to scale and do not represent detailed images of the respective products.



i Info

- EMC protection
- Corrosion-resistant
- Integrated cable gland

EPIC® ULTRA H-A 3 TG

The robust and reliable industry connector housing as EMC version



i Info

- EMC protection
- Corrosion-resistant
- Integrated cable gland

EPIC® ULTRA H-A 3 TS

The robust and reliable industry connector housing as EMC version



i Info

- EMC protection
- Corrosion-resistant

EPIC® ULTRA H-A 3 EGS

The robust and reliable industry connector housing as EMC version



Benefits

- Plugable with standard housings
- Optimum, low-resistance 360° screening
- All-purpose due to high corrosion resistance and high environmental protection.
- Space-saving due to compact dimensions
- High mechanical and chemical resistance

Application range

- In EMC-sensitive environments
- For fixed and flexible applications (e.g. machinery building, wind turbines)
- Construction machinery
- Electric motor manufacturing

Technical data

Classification ETIM 5/6
 ETIM 5.0/6.0 Class-ID: EC000437
 ETIM 5.0/6.0 Class-Description:
 Housing for industrial connectors

Material
 Housing: nickel-plated zinc diecasting
 Lever: stainless steel
 Sealing: NBR

IP Protection rating
 IP 65
 NEMA 250 (latched)

Temperature range
 -40°C to +100°C, short-term up to +125°C

Product features

- Resistance to cyclic salt spray is tested according to IEC 68-2-52, severity level 2
- Salt spray testing according to DIN EN ISO 9227, method NSS, period of test 480 hours
- Corrosion-resistant according to DIN EN 6988
- Delivery including stainless steel screw for the inserts

EPIC® ULTRA H-A 3 EGS

- Screw mounted housing with one cable entry

Article number	Article description	Braid diameter (min)	Clamping range min	Clamping range max	M	Pieces / PU
EPIC® ULTRA H-A 3 TG						
10423600	EPIC® ULTRA H-A 3 TGV 5-9 BRUSH	3	5	9		10
10423610	EPIC® ULTRA H-A 3 TGV 7-9 BRUSH	3	7	9		10
10423620	EPIC® ULTRA H-A 3 TGHV 6-13 BRUSH	6	6	13		10
10423630	EPIC® ULTRA H-A 3 TGHV 9-13,5 BRUSH	6	9	13.5		10
EPIC® ULTRA H-A 3 TS						
10423650	EPIC® ULTRA H-A 3 TSV 5-9 BRUSH	3	5	9		10
10423660	EPIC® ULTRA H-A 3 TSV 7-9 BRUSH	3	7	9		10
EPIC® ULTRA H-A 3 EGS						
10423640	EPIC ULTRA H-A 3 EGS M20				20	10

Photographs and graphics are not to scale and do not represent detailed images of the respective products.



EPIC® H-A 10

H-A connector insert up to 400V with service friendly screw connection



Info

- New higher voltage resistance, 400V in a small space
- Universal for current and voltage transmission

EPIC® H-A 16

H-A connector insert up to 400V with service friendly screw connection



Info

- New higher voltage resistance, 400V in a small space
- Universal for current and voltage transmission

Suitable housing

- EPIC® H-A 10
- EPIC® H-A 16

Similar products

- Further products with higher numbering in the internet. (H-A 32, H-A 48)

Benefits

- New higher voltage resistance, 400V in a small space
- Slim connector insert for standard application
- Service friendly screw connection for different cross section, PH1 screw heat suitable for electric screwdrivers
- Universal for current and voltage transmission
- Railway applications
 - Fire protection on railway vehicles: Test according EN 45545-2. Requirement sets R22 and R23. Hazard level HL1, HL2 and HL3

Application range

- Machine and equipment manufacturing
- Control engineering
- Plastics industry

Suitable tools

- Kraftform® adjustable torque screwdriver/ Kraftform Kompakt® Set

Technical data

	Classification ETIM 5/6 ETIM 5.0/6.0 Class-ID: EC000438 ETIM 5.0/6.0 Class-Description: Contact insert for industrial connectors		Contacts Copper alloy, hard silver-plated
	Rated voltage (V) IEC: 400 V UL: 600 V CSA: 600 V		Number of contacts EPIC® H-A 10 10 + PE EPIC® H-A 16 16 + PE
	Rated impulse voltage 4 kV		Termination methods Screw termination: 0.5 - 2.5 mm ²
	Rated current (A) IEC: 16 A UL: 14 A CSA: 16 A	Stripping length (mm)	8
	Pollution degree 3		Material PC, polycarbonate
	Flammability UL94 V-0		Cycle of mechanical operation 500
	Contact resistance 1.5 - 4 mohm		VDE-tested Certified production control: VDE-REG. no.: B437 UL-tested: UL File Number: E75770
			Temperature range -40°C to +120°C

Article number	Article description	Contact type	Wire protection	Number of operating contacts	Pieces / PU
H-A 10 screw termination					
10440100	H-A 10 SS	male	yes	1 - 10	5
10441100	H-A 10 BS	female	yes	1 - 10	5
10440000	H-A 10 SS	male		1 - 10	5
10441000	H-A 10 BS	female		1 - 10	5
H-A 16 screw termination					
10530000	H-A 16 SS	male	yes	1 - 16	5
10531000	H-A 16 BS	female	yes	1 - 16	5
10532000	H-A 16 SS	male		1 - 16	5
10533000	H-A 16 BS	female		1 - 16	5

Photographs and graphics are not to scale and do not represent detailed images of the respective products.

Similar products

- Further products with higher numbering in the internet. (H-A 32, H-A 48)



SKINTOP® HYGIENIC / SKINTOP® HYGIENIC SC

Info

- New: Available up to size M40x1,5
- Ideal for hygienic critical areas - resistant, edge-free, robust and reliable
- No gaps, voids or outer lying thread - so no risk of contamination of food machines, facilities or components
- Also available with EMC contact spring for screened cables



Benefits

- Hygienic Design for ideal cleaning results
- Smooth surfaces and no edges prevent the accumulation of fluids and formation of micro-organisms

Application range

- Food machinery, equipment and components
- For use in **product zone**
- Pharmaceutical industry

Norm references / Approvals

- EHEDG (TYPE EL Class I AUX) Hygienic design for machinery and components
- ECOLAB® Industry standard in the field of professional cleaning and disinfection in the food and beverage industry
- FDA 21 CFR 177.2600 Special sealing element for food and beverage industry in North America

- DIN EN 1672-2 Guideline for the design of machinery
- DIN EN ISO 14 159 Security of machinery Hygienic requirements for the design of machinery
- NSF/ANSI 169 Hygienic design for machinery and components

Product Make-up

- Material and shape provide an easy and safe cleaning
- By the blue coloring of the sealing material clearly distinguishable from foodstuffs
- One complete assembly is easily mounted from the outside
- Metric connection thread acc. to DIN EN 60423
- Basis for technical information DIN IEC 62444

Note

- Installation wrench for very high packing density on request

Technical data

Classification ETIM 5/6
 ETIM 5.0/6.0 Class-ID: EC000441
 ETIM 5.0/6.0 Class-Description: Cable screw gland

Certifications
 UL approval for M32x1,5 and M40x1,5 pending

Material
 Body: stainless steel - V4A (1.4404 / 316L)
 Insert: polyamide
 Sealing: special elastomer

Protection rating
 IP 68 - 10 bar
 IP 69
 NEMA Type 1, 2, 4x, 6, 12

Temperature range
 -20°C to +100°C

Article number	Article designation / size	Clamping range ØF mm	SW wrench size mm	Overall length C mm	Thread length D mm	Pieces / PU
SKINTOP® HYGIENIC						
53105100	M 12 x 1,5	4-6	16	38,4	6,5	5
53105110	M 16 x 1,5	6,5-9	20	41,4	7	5
53105120	M 20 x 1,5	9-12	24	46,4	8	5
53105130	M 25 x 1,5	11,5-15,5	29	48,9	8	5
53105140	M 32 x 1,5	16-20	36	56,0	9	5
53105141	M 40 x 1,5	22-27	45	62,0	9	5
SKINTOP® HYGIENIC SC						
53105300	M 12 x 1,5	4-6	16	39,9	6,5	5
53105301	M 16 x 1,5	6,5-9	20	43,4	7	5
53105302	M 20 x 1,5	9-12	24	46,4	8	5
53105303	M 25 x 1,5	11,5-15,5	29	48,9	8	5
53105314	M 32 x 1,5	16-20	36	56,0	9	5
53105315	M 40 x 1,5	22-27	45	62,0	9	5

Other sizes are available upon request.
 Photographs and graphics are not to scale and do not represent detailed images of the respective products.

Accessories

- SKINDICHT® SM-M INOX refer to main catalogue 2020/21

SKINTOP® cable glands nickel-plated brass metric • Flat cable



SKINTOP® FLAT

Cable gland with sealing insert for flat cables



Info

- Innovative, patented sealing construction enables IP68 over the entire clamping range

Benefits

- Specially designed sealing insert enables very high IP protection
- Wide, variable clamping ranges
- Suitable for both angular and round cable contours
- Even pressure distribution on the flat cable
- Halogen-free

Application range

- For inserting flat cables
- Conveyor and transport systems, indoor cranes and high-rack facilities
- Lifts
- Cable trolley systems
- Submersible pumps

Product Make-up

- Metric connection thread acc. to DIN EN 60423
- Technical information referring to DIN IEC 62444

Note

- Size M 63 x 1.5 and M 63 x 1.5 plus in preparation

Suitable tools

- SKINMATIC® QUICK Set 1
- SKINMATIC® MH Set
- SKINMATIC® RZ

Technical data

Classification ETIM 5/6
 ETIM 5.0/6.0 Class-ID: EC000441
 ETIM 5.0/6.0 Class-Description: Cable screw gland

Caution
 Tightening torques see installation instructions

Material
 Body: Nickel-plated brass
 Insert: Polyamid
 Sealing: NBR
 O-Ring: NBR

IP Protection rating
 IP 68 - 5 bar

Temperature range
 -20°C to +100°C

Article number	Article designation / size	Cable width min. / max. mm	Cable thickness min. / max. mm	SW wrench size mm	Overall length C mm	Thread length D mm	Pieces / PU
SKINTOP® FLAT							
53119375	M 25 x 1,5	11-16	3-6	29	37.5	8	5
53119376	M 32 x 1,5	15 - 20	3 - 7	36	42.2	9	5
53119377	M 40 x 1,5	18 - 28	3 - 9	45	49.5	9	5
53119378	M 50 x 1,5	26 - 33	5 - 11	54	52.0	10	5

Photographs and graphics are not to scale and do not represent detailed images of the respective products.

Accessories

- SKINDICHT® SM-M refer to main catalogue 2020/21

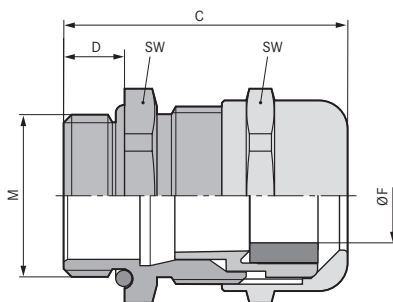



SKINTOP® MULTI



i Info

- Compact multi cable bushing system with innovative gel technology

Benefits

- Large clamping range of 4 mm and AS-I BUS entry system by elastic gel technology with innovative membrane technology
- Easy installation of the cables even for high packing density
- Optimum strain relief at the entire cable bundle
- Error reduction through clear assignment of cable to be installed by a clear marker of implementing points
- Not used bushings remain securely sealed

Application range

- Used in areas where a lot of cables and wires need to be inserted into housings with minimum space requirements
- For not harnessed cables and media hoses
- Apparatus and switch cabinet construction
- Automation technology

Product features

- Integrated seal for the cable & housing (captive)
- Halogen-free
- UV-, Ozon and oil resistant
- The adhesive gel provides a very easy positioning at the enclosure during the assembling

Norm references / Approvals

- UL 508A for Industrial Control Panels
- UL File No. E349737

Product Make-up

- For cut-outs for 24-pin industrial connectors (36 x 112 mm)

Included

- SKINTOP® MULTI including mounting material

Technical data

Classification ETIM 5/6
 ETIM 5.0/6.0 Class-ID: EC000240
 ETIM 5.0/6.0 Class-Description: Cable entry

Certifications
 UL File No. E349737
 Fire behaviour according to UL94 V-2

Note
 Individual hole configuration on request

Material
 Frame: Polycarbonat
 Sealing: Gel

Protection rating
 IP 68

Temperature range
 -30°C to +110°C

Article number	Article designation / size	Max. number of executions	Number of cables x cable Ø	Pieces / PU
SKINTOP® MULTI				
52220065	SKINTOP® MULTI Version 1	22	16 x 3-7 mm, 6 x 8-12 mm	1
52220073	SKINTOP® MULTI Version 2	21	5 x 2-6 mm, 8 x 4-8 mm, 3 x 5-9 mm, 2 x 8-12 mm, 1 x 12-16 mm, 2 x AS-I BUS / 2 x 2-4 mm	1
52220080	SKINTOP® MULTI Version 3	30	30 x 2-6 mm	1
52220085	SKINTOP® MULTI Version 4	11	8 x 8-12 mm, 2 x 12-16 mm, 1 x 16-20 mm	1
52220101	SKINTOP® MULTI Version 5	27	27 x 4-8 mm	1
52220104	SKINTOP® MULTI Version 6	24	10 x 2-6 mm, 8 x 4-8 mm, 4 x 7-11mm, 2 x 10-14mm	1

Photographs and graphics are not to scale and do not represent detailed images of the respective products.

Similar products

- SKINTOP® CUBE MULTI refer to main catalogue 2020/21
- SKINTOP® MULTI VENT refer to main catalogue 2020/21

Accessories

- SKINTOP® DIX-DV refer to main catalogue 2020/21



SKINTOP® MULTI-M

Cable bushing system with metric thread



Info

- Compact, round multi cable bushing system with innovative gel technology

Benefits

- Large clamping range of 4 mm per bushing due to elastic gel technology with innovative membrane technology
- Easy installation of the cables even for high packing density
- Optimum strain relief at the entire cable bundle
- Not used bushings remain securely sealed

Application range

- Used in areas where a lot of cables and wires need to be inserted into housings with minimum space requirements
- For not harnessed cables and media hoses
- Apparatus and switch cabinet construction
- Automation technology

Product features

- Cables can be inserted directly without using a pricking awl
- Secure sealing at the cable & housing
- High packing density
- Halogen-free and silicone-free
- UV-, Ozon and oil resistant

Norm references / Approvals

- UL pending

Included

- SKINTOP® MULTI-M including locknut and O-ring

Technical data

Classification ETIM 5/6
 ETIM 5.0/6.0 Class-ID: EC000240
 ETIM 5.0/6.0 Class-Description: Cable entry

Certifications
 UL pending
 Fire behaviour according to UL94 V-2

Note
 On request:
 - individual bushing configuration
 - other metric thread sizes

Material
 Frame: Polycarbonat
 Sealing: Gel
 O-Ring: NBR

Protection rating
 IP 68

Temperature range
 With O-ring: -30°C to +100°C
 Without O-ring: -30°C to +110°C

Article number	Article designation / size	Max. number of executions	Number of cables x cable Ø	SW wrench size mm	Pieces / PU
SKINTOP® MULTI-M					
52220110	M40x1,5	12	2 x 1-4 mm, 10 x 2-6 mm	46	1
52220111	M50x1,5	18	18 x 2-6 mm	55	1
52220112	M63x1,5	30	30 x 2-6 mm	66	1

Photographs and graphics are not to scale and do not represent detailed images of the respective products.

Similar products

- SKINTOP® DIX-M refer to main catalogue 2020/21
- SKINTOP® CUBE MULTI refer to main catalogue 2020/21
- SKINTOP® MULTI refer to page 41
- SKINTOP® MULTI VENT refer to main catalogue 2020/21

Accessories

- SKINTOP® DIX-DV refer to main catalogue 2020/21



SKINDICHT® MINI COLD

i Info

- For low temperature ranges up to -60°C

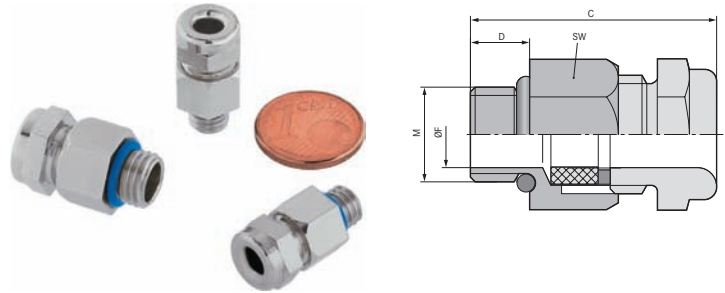

Benefits

- High degree of protection
- For the smallest conductor sizes
- Low height
- Gentle cable clamping
- High packing density

Application range

- For use wherever there is limited assembly space.
- Sensors
- Measurement and control technology

Product features

- Suitable for extreme minus temperatures

Technical data

Classification ETIM 5/6
 ETIM 5.0/6.0 Class-ID: EC000441
 ETIM 5.0/6.0 Class-Description: Cable screw gland

Caution
 Recommendation of torque
 M 6 x 1 1,5 Nm
 M 8 x 1 3,0 Nm
 M 10 x 1 6,0 Nm

Material
 Body: Nickel-plated brass
 Sealing: Silicone

IP Protection rating
 IP 66
 IP 68 - 5 bar

Temperature range
 -60°C to +100°C

Article number	Article designation / size	Clamping range ØF mm	SW wrench size mm	Overall length C mm	Thread length D mm	Clear opening F (mm)	Pieces / PU
SKINDICHT® MINI COLD							
52001877	M 6 x 1	2 - 3	9	19.7	5	3	50
52001878	M 8 x 1	3,5 - 5	11	20.5	5	5	50
52001879	M 10 x 1	5 - 7	14	22.3	5	7	50

Photographs and graphics are not to scale and do not represent detailed images of the respective products.

Accessories

- SKINDICHT® SM-M refer to main catalogue 2020/21



SKINDICHT® TWIST-M

Swivelling coupler with hexagonal collar



Benefits

- Exact positioning of e.g. elbowed fittings
- Swivelling coupler with increased sealing
- Prevents cables and conduits to get damaged due to (unintentionally) encountered torsional stress

Application range

- Control cabinet manufacturing
- Control systems
- Mechanical engineering
- For mobile equipment and machines
- In combination with metric threaded (conduit) fittings

Product features

- Swivelling upper part
- High sealing performance

Technical data



Classification ETIM 5/6

ETIM 5.0/6.0 Class-ID: EC000441
ETIM 5.0/6.0 Class-Description: Cable screw gland



Note

On request: size M12, M32, M40, M50, M63



Material

Body: nickel-plated brass
Spring ring: spring steel
Sealing: FKM



Protection rating

IP 68



Temperature range

-20°C up to +200°C

Article number	Thread, male M1	Thread, female M2	SW wrench size mm	Pieces / PU
SKINDICHT® TWIST-M				
52104731	16 x 1.5	16 x 1.5	20	10
52104732	20 x 1.5	20 x 1.5	24	10
52104733	25 x 1.5	25 x 1.5	29	5

Photographs and graphics are not to scale and do not represent detailed images of the respective products.

Accessories

- SKINDICHT® SM-M refer to main catalogue 2020/21



SILVYN® MSK-U-M

Universal metric threaded coupler with integrated cable strain relief, for use with conduit fittings

i Info

- Integrated SKINTOP® cable strain relief



Benefits

- Optimum cable and conduit strain relief
- Maximum cable sealing
- Fast and easy assembly
- Wide clamping range
- Anti-turn protection

Application range

- In combination with metric threaded conduit fittings
- Used in areas where cables and wires need to be provided with strain relief and additional sealing

Product features

- Combination of SILVYN® and SKINTOP®

Note

- For suitable accessories, refer to SKINTOP® metric accessories

Technical data

Classification ETIM 5/6
 ETIM 5.0/6.0 Class-ID: EC001180
 ETIM 5.0/6.0 Class-Description: Screw connection for protective metallic hose

Note
 On request: size M40, M50, M63

Material
 Body: nickel-plated brass
 Insert: Polyamide
 Sealing ring: CR/NBR
 O-ring: NBR

Protection rating
 Cable: IP 68
 Conduit: depending on the used conduit system

Temperature range
 Fixed: -40°C up to +100°C
 Dynamic: -25°C up to +100°C

Article number	Metric size	Clamping range in mm	Suitable gland size	Pieces / PU
SILVYN® MSK-U-M				
55506129	12 x 1.5	3.5 - 7.0	M 12 x 1,5	5
55506130	16 x 1.5	4.5 - 10.0	M 16 x 1,5	5
55506131	20 x 1.5	7.0 - 13.0	M 20 x 1,5	5
55506132	25 x 1.5	9.0 - 17.0	M 25 x 1,5	5
55506133	32 x 1.5	11.0 - 21.0	M 32 x 1,5	5

Photographs and graphics are not to scale and do not represent detailed images of the respective products.

Accessories

- SKINDICHT® SM-M refer to main catalogue 2020/21
- SKINTOP® DIX-M refer to main catalogue 2020/21
- SKINTOP® DIX-M AUTOMATION refer to main catalogue 2020/21
- SKINTOP® DIX-DV refer to main catalogue 2020/21



FLEXIMARK® Software 11.0



Info

- Technical support available in English free of charge (Phone: +4615577764, E-mail: support@fleximark.se)

Benefits

- For ease of use, the interface has been designed to be familiar to users of Microsoft® Office applications
- Enables printing of barcodes, QR-codes, logos, other pictures and serial codes
- Module marking for creation of panel strips
- Improved usability
- Image library including symbols used in electrical engineering

Application range

- Marking software that enables you to print all kinds of FLEXIMARK® labels easily and quickly

Product features

- Printer: laser, thermal transfer
- Available languages: German, English, Swedish and French
- Available barcodes: QR-Code, EAN-8, EAN-13, EAN-128, Code-128, Code-39, interleaved 2/5, UPC-A
- System requirements:
20 MB free hard disc space
Printer and driver for Microsoft® Windows 2000 or higher

Note

- Download www.lappkabel.com/service/downloadcenter/markingsystem
- Online update service for new labels via Internet

Included

- Operating manual and help function in the program

Article number	Article designation	Language	PU
FLEXIMARK® Software 11.0			
83251090	FLEXIMARK® Software 11.0	DE / EN / SE / FR	1

Photographs and graphics are not to scale and do not represent detailed images of the respective products.



FLEXIMARK® thermal printer SQUIX and EOS5*

i Info

- Technical support available in English free of charge (Phone: +4615577764, E-mail: support@fleximark.se)



Benefits

- High print speed (up to 150 mm/sec)
- High print resolution: 300 dpi
- Simple communication with FLEXIMARK® Software
- Basic maintenance such as cleaning the label sensor, changing the print head or print roller, can be easily done by yourself

Application range

- Printing on a variety of different materials (among others FLEXIMARK® shrink tube, cablelabel PUR and TA foam component marking)
- The thermal transfer printing method increases the smudge and scratch resistance of the printed surface, and provides increased resistance to oils and chemicals as well

Note

- For cutting of e.g. shrink tubes use optional cutter for the EOS 5
- For perforating flat shrink tubes use thermal transfer printer SQUIX together with the optional perforation cutter

Included

- FLEXIMARK® Software
- FLEXIMARK® thermal printer SQUIX or EOS5 with operating manual and service manual
- Windows® driver
- Power supply USB cable (length 1.8 m)

Technical data

Classification ETIM 5/6
 ETIM 5.0/6.0 Class-Description: Accessories for fax/printer/MFC

Dimensions
 SQUIX: 274x242x446 mm (HxWxD)
 EOS5: 245x264x412mm (HxWxD)

Label rolls
 Material thickness:
 0.055-1.2 mm (SQUIX)
 0.055-0.7 mm (EOS5)
 Carrier width:
 10-120 mm (SQUIX)
 10-116 mm (EOS5)
 Max. core diameter Ø:
 38.0-100.0mm (SQUIX)
 38-76mm (EOS5)

Ribbons
 Run length up to 500m (SQUIX) or 360m (EOS5)

Speed
 EOS5: Up to 150.00 mm/s
 SQUIX: Up to 300,00 mm/s

Weight
 SQUIX: 9.0 kg
 EOS5: 5 kg

Material
 Labels or continuous material on coils

Article number	Article designation	PU
FLEXIMARK® thermal printer SQUIX and EOS5*		
83259532	FLEXIMARK® Thermoprint EOS5/300	1
83259602	FLEXIMARK® Thermoprinter SQUIX 4/300M	1
83259536	FLEXIMARK® Cutter EOS5	1
83259603	FLEXIMARK® Perforation cutter PCU400 SQUIX	1

* Trade product, no Lapp product
 Photographs and graphics are not to scale and do not represent detailed images of the respective products.
 FLEXIMARK® products are sold in packaging units. As example if you like to order 640 labels of LCK 32 you just need to order 1 PU instead of 640 single labels.

Accessories

- FLEXIMARK® ribbons SQUIX, EOS4 and EOS5 refer to main catalogue 2020/21

PEW 12 universal tool



Benefits

- Parallel jaw closing
- Ergonomic handles
- One or two-hand operation
- Inserts are easily changeable

Application range

- Compatible with most of the crimping dies for the PEW 12 system (see product description of the crimping dies)
- Crimping of almost all crimped connections with conductor cross-sections 0.08-95 mm²

Product features

- Version PEW 12S has a larger opening angle and is therefore intended for the larger PEW 12S crimping dies (see item description of the crimping dies)

Included

- Crimping tool will be delivered without case and without inserts
- Empty case included placeholders for 15 crimping dies and 4 locators

Technical data

ETIM	Classification ETIM 5/6
	ETIM 5.0/6.0 Class-ID: EC000168 ETIM 5.0/6.0 Class-Description: Crimp tool cable lugs, cable end sleeves, screen connection
RAL	Colour delivered Burnished Chrome-plated pressing pliers available upon request (article no. 61813800)

Article number	Article designation	Pieces / PU
Pliers		
61813807	PEW 12 without inserts	1
61814610	PEW 12S without inserts	1
61813819	Case for PEW 12	1

Photographs and graphics are not to scale and do not represent detailed images of the respective products.

Accessories

- Crimping inserts for PEW 12 system refer to page 49

E-PEW 12 universal tool



Benefits

- Electromechanical tool with Li-Ion battery
- Dependable, reliable, low maintenance
- Precise tap positioning of contacts
- Quickstop, no overcrimping
- Process monitoring on multifunction display:
 - Battery charge level
 - Service interval display
 - Overheating / overload warning

Application range

- Compatible with most of the crimping dies for the PEW 12 system (see product description of the crimping dies)
- Crimping of almost all crimped connections with conductor cross-sections 0.08-95 mm²
- Various applications in the cable assembly

Included

- Supplied in plastic case (500 x 420 x 125 mm)
- Tool without crimping dies and locators
- Including battery and battery recharger

Technical data

ETIM	Classification ETIM 5/6
	ETIM 5.0/6.0 Class-ID: EC000168 ETIM 5.0/6.0 Class-Description: Crimp tool cable lugs, cable end sleeves, screen connection
RAL	Colour delivered Black

Article number	Article designation	Weight (kg)
E-PEW 12 universal tool		
61813817	E-PEW 12	4.7

Photographs and graphics are not to scale and do not represent detailed images of the respective products.

Accessories

- Crimping inserts for PEW 12 system refer to page 49

Crimping inserts for PEW 12 system

Benefits

- Product code is engraved on the upper and on the lower part of the die set
- Inserts are easily changeable

Note

- High flexibility: Interchangeable inserts that fit into either the PEW 12 / PEW 12S manual crimping tool, the E-PEW 12 electric crimping tool or the CM 25-1 crimping machine (compatibility see table)

Included

- Crimping dies are delivered without tool

Info

- Extended portfolio

Technical data



Classification ETIM 5/6

ETIM 5.0/6.0 Class-ID: EC001282
 ETIM 5.0/6.0 Class-Description: Insert for crimp tool cable lugs, cable end sleeves, screen connection



Article number	Article designation	Suitable for	Pressing range (mm ²)	Crimping profile	Shield Ø mm	PEW 12	PEW 12S	E-PEW	CM 25-1	Pieces / PU
Insulated and non-insulated conductor end sleeves										
61813802	PEW 12.090		0,5 - 6,0	trapezoid		x		x	x	1
61813803	PEW 12.091		10,0 - 25,0	w-pressing		x		x	x	1
61813993	PEW 12.331		35,0 - 50,0	w-pressing		x		x		1
61813911	PEW 12S.093		70	w-pressing			x	x		1
61813912	PEW 12S.094		95	w-pressing			x	x		1
TWIN end sleeves										
61813913	PEW 12.090-6		2x0,5 - 2x4	trapezoid		x		x	x	1
61815642	PEW 12.097		2x6 - 2x16	w-pressing		x		x	x	1
Insulated cable lugs and panel connectors										
61813914	PEW 12.064		0,14 - 1	conical ISO crimp		x		x		1
61813915	PEW 12.064 Locator		0,14 - 1			x		x		1
61813812	PEW 12.060		0,5 - 6,0	conical ISO crimp		x		x		1
Non-insulated cable lugs										
61813916	PEW 12.1071		0,5 - 10	w-pressing		x		x	x	1
61813862	PEW 12.033		16 - 25	mandrel pressing		x		x	x	1
Non-insulated panel connectors										
61814600	PEW 12.045	Tab width 2,8	0,1 - 2,5	roller pressing		x		x		1
61814601	PEW 12.045 Locator	Tab width 2,8	0,1 - 2,5			x		x	x	1
61813991	PEW 12.838	Tab width 4,8	0,5 - 1,5	roller pressing		x		x	x	1
61813992	PEW 12.838 Locator	Tab width 4,8	0,5 - 1,5			x		x	x	1
61813808	PEW 12.050	Tab width 6,3	0,5 - 6,0	roller pressing		x		x	x	1
61813809	PEW 12.050 Locator	Tab width 6,3	0,5 - 6,0			x		x	x	1
61815643	PEW 12.743	Tab width 6,3	1,5 - 2,5	roller pressing		x		x	x	1
61815644	PEW 12.743 Locator	Tab width 6,3	1,5 - 2,5			x		x	x	1
61815645	PEW 12.745-1	Tab width 6,3	4 - 6	roller pressing		x		x	x	1
61815646	PEW 12.745-1 Locator	Tab width 6,3	4 - 6			x		x	x	1
One piece screen connectors RSK										
61815635	PEW 12.1448/101 A	RSK 5101		special crimping profile	1,2-1,7	x		x		1
61815636	PEW 12.1449/101 B	RSK 5101		special crimping profile	1,8-2,2	x		x		1
61815637	PEW 12.1450/201 C	RSK 5201		special crimping profile	2,2-2,5	x		x		1
61815638	PEW 12.1341/201 D	RSK 5201		special crimping profile	2,5-3,0	x		x		1
61815639	PEW 12.1451/201 E	RSK 5201		special crimping profile	3,0-3,3	x		x		1
61815640	PEW 12.1452/201 F	RSK 5201		special crimping profile	3,3-3,6	x		x		1
61815641	PEW 12.1453/301 G	RSK 5301		special crimping profile	3,6-4,1	x		x		1
61813869	PEW 12.374/301 H	RSK 5301		special crimping profile	4,1-4,7	x		x		1
61813868	PEW 12.373/301 J	RSK 5301		special crimping profile	4,7-5,1	x		x		1
61813864	PEW 12.599/401 K	RSK 5401		special crimping profile	5,1-5,8	x		x		1
61813865	PEW 12.375/401 L	RSK 5401		special crimping profile	5,8-6,3	x		x		1
61813866	PEW 12.354/401 M	RSK 5401		special crimping profile	6,3-7,0	x		x		1
61813867	PEW 12.619/401 N	RSK 5401		special crimping profile	7,0-7,6	x		x		1
Two-part screen connectors SHIELD-KON®										
61813881	PEW 12.1425 SK	GSC 101 / 128 / 149 / 156 / 175		hexagonal pressing		x		x		1
61813882	PEW 12.1426 SK	GSC 187 / 194 / 199 / 205 / 219 / 225 / 232		hexagonal pressing		x		x		1
61813883	PEW 12.1427 SK	GSC 261 / 275 / 281 / 287 / 297		hexagonal pressing		x		x		1
61813884	PEW 12.1428 SK	GSC 312 / 327 / 348		hexagonal pressing		x		x		1
61813885	PEW 12.1429 SK	GSC 359 / 375		hexagonal pressing		x		x		1
61813886	PEW 12.1430 SK	GSC 405 / 415 / 425		hexagonal pressing		x		x		1
61813887	PEW 12S.1440 SK	GSC 460 / 500		hexagonal pressing			x	x		1

Photographs and graphics are not to scale and do not represent detailed images of the respective products.



Shrink tube PROTECT-HF

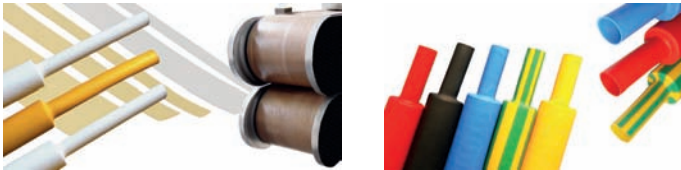

Info

- Thin walled
- Halogen-free

Benefits

- Flexible
- Halogen-free products do not develop corrosive or toxic gases in the event of a fire, are flame-retardant, show little fire propagation and develop only little smoke
- PROTECT-HF RW: Can be flattened for marking purposes, suitable for railway applications

Application range

- Insulation, protection and cable bundling
- Green-yellow shrink tube: For identifying and marking earthing connectors and cables
- PROTECT-HF RW: For railway applications and marking systems

Product features

- Halogen-free
- Good chemical resistance
- Flame retardant
- Silicone-free
- UV-resistant (only colour: black)

Norm references / Approvals

- PROTECT-HF / Box: Flammability class FMVSS 302
- PROTECT-HF RW: Flammability class ASTM D 635-HB, Railway normative (BS-6853 (1999) Vehicle category 1A, EN 45545-2 HL 3, LUL 1-085 A3), Boeing BSS 7239 toxic gas generation M7

Included

- PROTECT-HF Box: Stackable boxes for easy storage
- PROTECT-HF: Plastic bag with 1.22 m units
- PROTECT-HF RW: Delivered on spool

Suitable tools

- HG 2320 hot-air pistol refer to main catalogue 2020/21

Technical data

	Classification ETIM 5/6 ETIM 5.0/6.0 Class-ID: EC000217 ETIM 5.0/6.0 Class-Description: Shrink tubing
	On request Other colours are available upon request
	Note Thin walled Dielectric strength: 20 kV/mm
	Info Shrinking ratio: 2:1
	Colour delivered Black, Green-yellow, Yellow, White
	Material Polyolefin
	Temperature range Shrinking temperature: +90°C PROTECT-HF / Box: -30 °C to +105 °C PROTECT-HF RW: -55°C to +105°C

Article number	Article description	Colour	Shrinkage range (mm)	Panel thickness, shrunk +/- 0.1 mm	Contents (m)	PU
Shrink tube PROTECT-HF Box						
61742489	PROTECT-HF Box 1,2/0,6 BK	black	1.2 - 0.6	0,41	15	1
61742490	PROTECT-HF Box 1,6/0,8 BK	black	1.6 - 0.8	0,43	15	1
61742491	PROTECT-HF Box 2,4/1,2 BK	black	2.4 - 1.2	0,51	15	1
61742492	PROTECT-HF Box 3,2/1,6 BK	black	3.2 - 1.6	0,51	15	1
61742493	PROTECT-HF Box 4,8/2,4 BK	black	4.8 - 2.4	0,51	12	1
61742494	PROTECT-HF Box 6,4/3,2 BK	black	6.4 - 3.2	0,65	12	1
61742495	PROTECT-HF Box 9,5/4,7 BK	black	9.5 - 4.7	0,65	10	1
61742496	PROTECT-HF Box 12,7/6,4 BK	black	12.7 - 6.4	0,65	8	1
61742497	PROTECT-HF Box 19,1/9,5 BK	black	19.1 - 9.5	0,77	5	1
61742498	PROTECT-HF Box 25,4/12,7 BK	black	25.4 - 12.7	0,89	3	1
Shrink tube PROTECT-HF						
61742472	PROTECT-HF 1,2/0,6 BK	black	1.2 - 0.6	0,41	61	1
61742473	PROTECT-HF 1,6/0,8 BK	black	1.6 - 0.8	0,43	61	1
61742474	PROTECT-HF 2,4/1,2 BK	black	2.4 - 1.2	0,51	61	1
61742475	PROTECT-HF 3,2/1,6 BK	black	3.2 - 1.6	0,51	61	1
61742476	PROTECT-HF 4,8/2,4 BK	black	4.8 - 2.4	0,51	61	1
61742477	PROTECT-HF 6,4/3,2 BK	black	6.4 - 3.2	0,65	30.5	1
61742478	PROTECT-HF 9,5/4,7 BK	black	9.5 - 4.7	0,65	30.5	1
61742479	PROTECT-HF 12,7/6,4 BK	black	12.7 - 6.4	0,65	30.5	1
61742480	PROTECT-HF 19,1/9,5 BK	black	19.1 - 9.5	0,77	30.5	1
61742481	PROTECT-HF 25,4/12,7 BK	black	25.4 - 12.7	0,89	18.3	1
61742482	PROTECT-HF 3,2/1,6 GN/YE	green-yellow	3.2 - 1.6	0,51	61	1
61742483	PROTECT-HF 4,8/2,4 GN/YE	green-yellow	4.8 - 2.4	0,51	61	1
61742484	PROTECT-HF 6,4/3,2 GN/YE	green-yellow	6.4 - 3.2	0,65	30.5	1
61742485	PROTECT-HF 9,5/4,7 GN/YE	green-yellow	9.5 - 4.7	0,65	30.5	1
61742486	PROTECT-HF 12,7/6,4 GN/YE	green-yellow	12.7 - 6.4	0,65	30.5	1
61742487	PROTECT-HF 19,1/9,5 GN/YE	green-yellow	19.1 - 9.5	0,77	30.5	1
61742488	PROTECT-HF 25,4/12,7 GN/YE	green-yellow	25.4 - 12.7	0,89	18.3	1

Article number	Article description	Colour	Shrinkage range (mm)	Panel thickness, shrunk +/- 0.1 mm	Contents (m)	PU
Shrink tube PROTECT-HF RW						
61742499	PROTECT-HF RW 2,4/1,2 BK	black	2.4 - 1.2	0.43 - 0.6	300	1
61742501	PROTECT-HF RW 3,2/1,6 BK	black	3.2 - 1.6	0.55 - 0.72	300	1
61742502	PROTECT-HF RW 4,8/2,4 BK	black	4.8 - 2.4	0.55 - 0.72	300	1
61742503	PROTECT-HF RW 6,4/3,2 BK	black	6.4 - 3.2	0.65 - 0.8	300	1
61742504	PROTECT-HF RW 9,5/4,7 BK	black	9.5 - 4.7	0.65 - 0.75	150	1
61742505	PROTECT-HF RW 12,7/6,4 BK	black	12.7 - 6.4	0.65 - 0.75	100	1
61742506	PROTECT-HF RW 19,1/9,5 BK	black	19.1 - 9.5	0.7 - 0.85	50	1
61742507	PROTECT-HF RW 25,4/12,7 BK	black	25.4 - 12.7	0.85 - 1.0	50	1
61742508	PROTECT-HF RW 2,4/1,2 WH	white	2.4 - 1.2	0.43 - 0.6	300	1
61742509	PROTECT-HF RW 3,2/1,6 WH	white	3.2 - 1.6	0.55 - 0.72	300	1
61742510	PROTECT-HF RW 4,8/2,4 WH	white	4.8 - 2.4	0.55 - 0.72	300	1
61742511	PROTECT-HF RW 6,4/3,2 WH	white	6.4 - 3.2	0.65 - 0.8	300	1
61742512	PROTECT-HF RW 9,5/4,7 WH	white	9.5 - 4.7	0.65 - 0.75	150	1
61742513	PROTECT-HF RW 12,7/6,4 WH	white	12.7 - 6.4	0.65 - 0.75	100	1
61742514	PROTECT-HF RW 19,1/9,5 WH	white	19.1 - 9.5	0.7 - 0.85	50	1
61742523	PROTECT-HF RW 25,4/12,7 WH	white	25.4 - 12.7	0.85 - 1.0	50	1
61742515	PROTECT-HF RW 2,4/1,2 YE	yellow	2.4 - 1.2	0.43 - 0.6	300	1
61742516	PROTECT-HF RW 3,2/1,6 YE	yellow	3.2 - 1.6	0.55 - 0.72	300	1
61742517	PROTECT-HF RW 4,8/2,4 YE	yellow	4.8 - 2.4	0.55 - 0.72	300	1
61742518	PROTECT-HF RW 6,4/3,2 YE	yellow	6.4 - 3.2	0.65 - 0.8	300	1
61742519	PROTECT-HF RW 9,5/4,7 YE	yellow	9.5 - 4.7	0.65 - 0.75	150	1
61742520	PROTECT-HF RW 12,7/6,4 YE	yellow	12.7 - 6.4	0.65 - 0.75	100	1
61742521	PROTECT-HF RW 19,1/9,5 YE	yellow	19.1 - 9.5	0.7 - 0.85	50	1
61742522	PROTECT-HF RW 25,4/12,7 YE	yellow	25.4 - 12.7	0.85 - 1.0	50	1

Photographs and graphics are not to scale and do not represent detailed images of the respective products.

CHAMPION Drum dispenser

Info

- For professional and gentle unwinding of even sensitive cables

Technical data

Dimensions
52: 577x565x120mm
67: 727x565x120mm

General data
Weight:
52: 7.2kg
67: 9.3kg
Material: glass-fiber reinforced polyamide and aluminium

- Benefits**
- Robust construction with 200kg load capacity
 - Safer stability thanks to noise-reducing rubber feet
 - Easily adjustable carrier rollers with 3 different positions
 - Maintenance-free

- Application range**
- Drum dispenser for everyday use in the workshop or on the construction site
 - Also as storage solution in the workshop
 - With additional rollers for mobile use

- Product features**
- For drum diameter from 150 up to 900mm
 - Available in two sizes for drums up to 520 or 670mm width
 - Lightweight hybrid frame made of glass fiber reinforced polyamide and aluminium
 - Provided with 4 non-slip rubber feet
 - Optionally with 4 rollers for drum transport



Article number	Article designation
CHAMPION Drum dispenser	
85008070	CHAMPION 52
85008071	CHAMPION 67
85008072	CHAMPION Steering rollers set
85008073	CHAMPION Rubber feet (4 pc)

Photographs and graphics are not to scale and do not represent detailed images of the respective products.

Notes

Reach us around the world

...or closer to home. To contact your local LAPP representative:

PLEASE VISIT

www.lappgroup.com/worldwide

Enter the world
of LAPP:



Follow LAPP on:



Image source: LAPP, Maiwolf, Wolfram Scheible, Bystronic glass, Comau SpA, EMAG, Fotolia, iStock

The following applies for the use of our products

The conformity of our products to the relevant European directives and compliance with the provisions contained therein shall be indicated by the CE marking.

The safety of our products is closely associated with how they are used. A knowledge of and adherence to the respective international/national standards of use (e.g. DIN VDE 0100; 0298) are

mandatory. There are particular risks if installed improperly. This applies to all our products/items:

Processing is only to be done by an authorised electrician! Otherwise, there is the risk of an electric shock or a fire ignited by electric current!

Safety

Without exception, our products are tested for application safety in accordance with defined standards and our own regulations, which complement the standards. Relevant legal requirements and safety regulations are also observed. Provided due care and attention is paid, the possibility of product-specific danger to the user may thus reasonably be excluded. Where products are used carelessly or incorrectly, however, considerable danger to persons and the

environment may arise. For this reason, our cables must only be processed and/or used responsibly by trained electricians or specialists. This catalogue contains general information for the application of each product. Independent of such information, the application standards DIN VDE 0298 and DIN VDE 0891 for cables will apply. Excerpts from these standards, as well as complementary selection and application tables, design and installation

guidelines, are contained in the tables in the appendix to this catalogue. Our machines and installation tools are - where necessary - designed in accordance with the machine guidelines and display the CE identification mark. It must be noted, however, that our machines and installation tools must only be used by trained specialist personnel and for the purpose for which they were designed.

©Copyright by U.I. Lapp GmbH. Reprinting or reproduction of the text or the illustrations may be made only with written approval and with correct indication of source. We reserve the right to make modifications to our products, especially those based on technical improvements or continued development. All illustrations and numerical data etc. are therefore without warranty and are subject to change.



ÖLFLEX®
Power and control cables



UNITRONIC®
Data communication systems



ETHERLINE®
Data communication systems
for ETHERNET technology



HITRONIC®
Optical transmission systems



EPIC®
Industrial connectors



SKINTOP®
Cable glands



SILVYN®
Protective cable conduit systems
and cable carrier systems



FLEXIMARK®
Marking systems

Follow LAPP on



Terms of Trade:

Our general conditions of sale
can be downloaded from our website
www.lappgroup.com/terms



www.lappgroup.com

To contact your local LAPP representative,
please visit www.lappgroup.com/worldwide