

# THE WORLD OF LAPP

Automation & Network Guide



**LAPP GROUP**





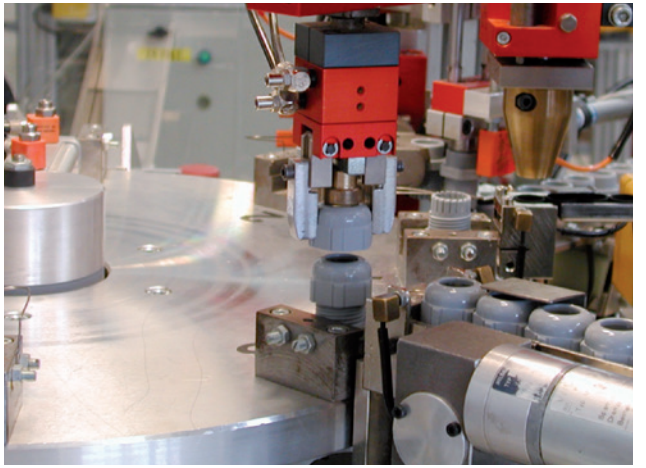





Automation & Network  
made by Lapp

































# Legend for icons

## INDUSTRIES

	Automation
	e-Mobility
	Food & Beverage
	Mechanical and Plant Engineering
	Oil & Gas
	Rail
	Solar Energy
	Wind Energy

## PRODUCT CHARACTERISTICS

	Good chemical resistance		Suitable for outdoor use
	ETIM		Flame-retardant
	Wide clamping range		Halogen-free
	Heat-resistant		Cold-resistant
	Assembly time		Corrosion-resistant
	Oil-resistant		Maximum vibration protection
	Space requirement		Mechanical resistance
	Power chain		Low weight
	Acid-resistant		Optimum strain relief
	Reliability		Robust
	Integrated SKINTOP® cable gland		Temperature-resistant
	Voltage		Torsion-resistant
	Connector with standard housing unit		UV-resistant
	Interference signals		Waterproof
	Variety of approval certifications		Torsion load

**Please note:** the purpose of the icons is to provide you with a quick overview and a rough indication of the product features to which the corresponding information relates. You can find details of product characteristics in the “technical data” sections on the product pages.

Bem-vindo

**Добро пожаловать**

Witamy

Varmt välkommen

欢迎光临 **Vítáme vás**

Hoş geldiniz

**Herzlich willkommen**

Ласкаво просимо

Bienvenue  
환영합니다

*Hartelijk welkom*

**Welcome**

Bienvenidos

Bine ați venit

**Benvenuti**

**Welcome**

To contact your local Lapp Group representative please visit [www.lappgroup.com/worldwide](http://www.lappgroup.com/worldwide)

▶ THIS CATALOGUE  
IS VALID FROM  
NOVEMBER 2014.



# Content

Informations  
about the  
company

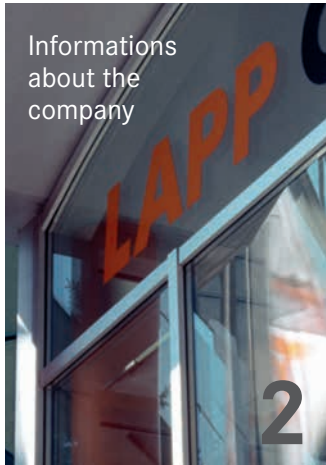

2

ÖLFLEX®  
Power and  
control cables



5

UNITRONIC®  
Data communication  
systems



21

ETHERLINE®  
Data communication  
systems for  
ETHERNET technology



141

HITRONIC®  
Optical transmission  
systems



201

EPIC®  
Industrial connectors



255

SKINTOP®  
Cable glands



259

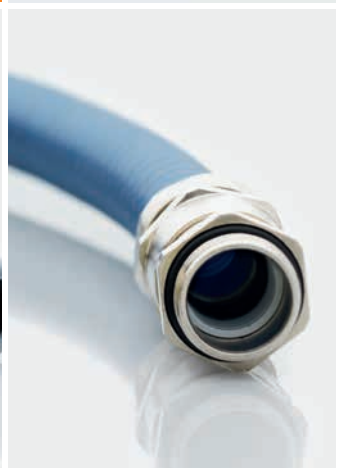

FLEXIMARK®  
Marking systems



271

Appendix



275



## Brand quality from Stuttgart



### ÖLFLEX® Power and control cables

The world's first brand cable is available in the most varied of versions to match maximum requirements.

**Key features:** Oil-resistant, flexible and available to match almost any requirement or environmental condition – also free of halogens.

**Fields of application:** Multipurpose. Special variants are increasingly in demand in the area of renewable energies.



### EPIC® Industrial connectors

The brand for strong and reliable connections.

**Key features:** Robust square and circular connectors. Flexible system consisting of housings, inserts, contacts and accessories – the tailor-made solution for every requirement. Similarly, EPIC® SOLAR plugs for photovoltaics are also part of the extensive product range. **Fields of application:** Mechanical and systems engineering, drive technology, automation.



### UNITRONIC® Data communication systems

The ideal brand for fast, trend-setting and reliable data transfer. **Key features:** UNITRONIC® are not only data lines, but also bus lines, which together with active sensor/actuator modules or gateways provide a perfect system for automation. **Fields of application:** Measurement, control, regulation, bus or LAN networks.



### SKINTOP® Cable glands

The brand for quickly fastened, centred and hermetically sealed cable entries. **Key features:** Large clamping areas, optimum strain reliefs, wide range of versions such as SKINTOP® CLICK, COLD or CUBE. **Fields of application:** Everywhere, where cables must be fastened reliably and quickly.



### ETHERLINE® Data communication systems for ETHERNET technology

The brand for network solutions, safety systems and firewalls in the industrial networking sector. **Key features:** System solutions consisting hardware, software, consulting, network design and support. **Fields of application:** Factory automation, renewable energy, building technology, structured cabling.



### SILVYN® Protective cable conduit systems and cable carrier systems

The brand for all-round cable protection. **Key features:** The product range includes SILVYN® cable protection hoses for perfect protection against mechanical and chemical loads, along with SILVYN® CHAIN energy supply chains for highly dynamic applications. **Fields of application:** Everywhere where cables have to be additionally protected or routed.



### HITRONIC® Optical transmission systems

The brand for split-second, fault-free, intercept-free data transport. **Key features:** The HITRONIC® product range includes fibre optic cables in a range of versions along with suitable accessories such as splice boxes, wall distributors or couplings. **Fields of application:** Office and industrial sector, renewable energy.



### FLEXIMARK® Marking systems

The brand for permanent, clearly arranged cable markings. **Key features:** Comprehensive range – from manual labelling solutions to digital identification. Withstands high chemical, thermal and mechanical loads. **Fields of application:** All cable, single cores, control cabinets.

# Reliably connecting the world

We want to help you become even more productive and successful. This is why we work tirelessly on optimising our processes. We do everything to make sure we always find the best solution for you and also provide you with quick, efficient and effective support.

No matter where you are – we are always by your side. Our plants, sales companies, partners and, above all, our competent teams of advisers ensure we offer you a comprehensive service on every continent. We do not simply distribute cable technology, we also

manufacture our products ourselves – which represents another advantage for you. As a manufacturer with 17 of our own production facilities, you will benefit from our expertise in the development, design and manufacture of cables, system products and cable accessories. Thanks to this expertise, we can guarantee that Lapp will provide you with the quality that you require and that you demand.

You can always rely on quality from Lapp – wherever you are in the world. This is also embodied by our strong brands.



[www.lappgroup.com/worldwide](http://www.lappgroup.com/worldwide)



## Product finder – don't search, find it!

The Lapp Group not only offers you more than 40,000 articles, but also the quickest way to find the right cables, connectors and whatever else you need.

- Straightforward selection of the desired filter properties for quickly finding the product of your choice.
- Possible to order immediately from the e-shop.
- Fast interactive product finder.

Simply use our product finder at

[www.lappgroup.com/productfinder](http://www.lappgroup.com/productfinder)

### CABLE ASSEMBLY FINDER

Based on criteria such as the number of pins, connector/female, sheath material and cable length, you are able to find the suitable cable assembly in a matter of moments from the following areas:

- UNITRONIC® Sensor/actuator
- ETHERLINE® Industrial Ethernet
- UNITRONIC® Fieldbus
- HITRONIC® Fibre optic cable

[www.lappgroup.com/assemblyfinder](http://www.lappgroup.com/assemblyfinder)

### CABLE FINDER

Based on criteria such as the number of cores, cross-section in mm<sup>2</sup> and nominal voltage, it directs you to the correct article in seconds.

[www.lappgroup.com/cablefinder](http://www.lappgroup.com/cablefinder)

### CABLE GLAND FINDER

Use the SKINTOP® Finder to help you identify the cable gland you need and the required accessories. What's more, the online catalogue provides you with a direct route to your order or to more detailed product information.

[www.lappgroup.com/cable-glandfinder](http://www.lappgroup.com/cable-glandfinder)

### CONNECTOR FINDER

Design, insert, housing and counterpart. These four selections take you to the appropriate connector in just a few clicks.

[www.lappgroup.com/connectorfinder](http://www.lappgroup.com/connectorfinder)

### CONNECTOR HOUSING CONFIGURATOR

Configure your own individual industrial connector housing with locking concept and cable entries.

[www.lappgroup.com/connector-housing](http://www.lappgroup.com/connector-housing)

### CABLE MARKING FINDER

Use our FLEXIMARK® Cable Marking Finder to quickly identify the appropriate marking and labelling for your application. You can also view the corresponding accessories and more detailed product information.

[www.lappgroup.com/markfinder](http://www.lappgroup.com/markfinder)

### CHARGING CABLE CONFIGURATOR

The Charging Cable Configurator enables you to find the cables and connectors you need to create the perfect charging cable in no time.

[www.lappgroup.com/emobility-cablefinder](http://www.lappgroup.com/emobility-cablefinder)





# ÖLFLEX®

Power and control cables

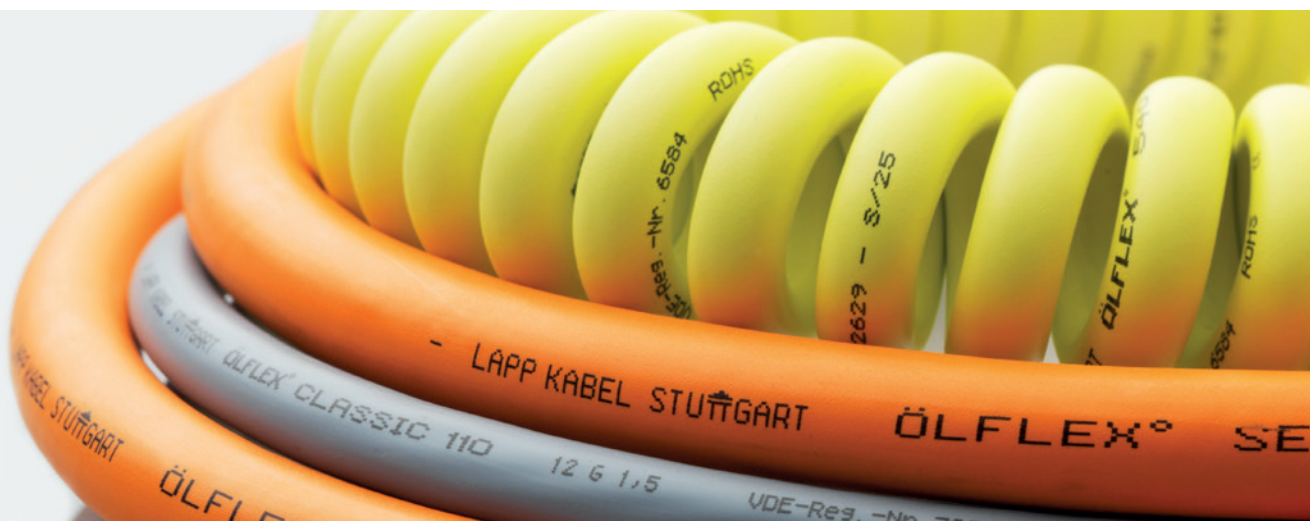

Assemblies, Connectors and Flexible Cables for Drive Systems..... 6

**Product Pages** ..... 7

For current information see [www.lappgroup.com/products](http://www.lappgroup.com/products)

## Assemblies, Connectors and Flexible Cables for Drive Systems

Whether you need the connector, the cable or even the entire assembly for your application, we offer everything from a single source. We also supply the single-cable solution (Hiperface DSL). In our catalogue, we can only present a certain part of our product range. Feel free to contact us.

### Assemblies for drive systems

**Cost reduction:**

Compared with self-assembly => cost reduction in logistics, construction, installation, and purchasing.

**100% safety:**

Cables and connectors are carefully matched to the requirements. All cable sets are individually tested = 100% inspection. (Test logs)

**Just in time:**

All cable assemblies can also be supplied at very short notice.

Standard assemblies for all current drives. Assemblies according to customer requirements for your drive system, even in small batches.

Encoder assembly



Motor assembly



Customer specific assembly



### Connector for drive systems

**Complete range:**

All circular connectors from EPIC® M12 to EPIC® LS3 as well as the EPIC® rectangular connectors.

**Service:**

Data sheets, installation instructions and 3D models are available.

**Quality:**

The connectors feature only the highest quality materials, such as FKM seals, gold-plated contacts, which come with a closed sleeve in the mating area, integrated SKINTOP® EMC cable gland and much more.

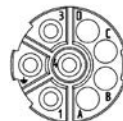

### Flexible motor and encoder cables for drive systems

**Complete range:**

Various cable types in stock for static or highly flexible applications in servo drive systems from renowned manufacturers.

**Service:**

Available from stock as coils, on drum or custom cutting length.

**Quality:**

Proven ÖLFLEX® quality – tested according to strict testing requirements and under the latest laboratory and test conditions.

LAPP KABEL STUTTGART ÖLFLEX® SERVO FD 798 CP

LAPP KABEL STUTTGART ÖLFLEX® SERVO FD 796 CP CE



## Servo harnessing according to SEW®



### Benefits

- Servomotors, resolvers and encoder cables for fixed installation or application in power supply chains
- Outer sheath makes them particularly suitable for use in industrial areas

### Application range

- Plant engineering
- Servo drives and servo assemblies

### Product features

- Design according to specific drive systems:
- Flame-retardant according IEC 60332-1-2

### Note

- For the highly flexible version, please observe the assembly guidelines for cables in power chain systems.
- Maximum cable length must comply with the specifications set by the manufacturer of the respective servo drives
- The technical data correspond to the cables used

### Design

- Other versions and lengths can be delivered upon request.

### Technical data

	<b>Classification</b> ETIM 5.0 Class-ID: EC000104 ETIM 5.0 Class-Description: Control cable
	<b>Approvals</b> Power cable: UL AWM Style 2587
	<b>Minimum bending radius</b> Power cable occasional flexing: 15 x cable diameter Signal cable for flexible installation: 15 x outer diameter
	<b>Nominal voltage</b> Power cable: power cores: IEC 750 V, UL 600 V Signal cores: IEC 350 V, UL 600 V Signal cable: 250 V
	<b>Test voltage</b> Power cable: 2 KV Signal cable: 1.5 KV
	<b>Temperature range</b> Flexing power cable: -10 °C to +80 °C Signal cable flexing: -5 °C to +70 °C

Article number	Length (m)	SEW item designation	Static	Highly flexible	Number of cores and mm² per conductor	Copper index kg/ 1.000 pieces	Other dimensions	PU
<b>Motor cables</b>								
70430251	10.0	05904544	•		4G 1,5	880.0	Other lengths are available upon request	1
70430250	10.0	13324853	•		4G1,5+3x1	1,510.0	Other lengths are available upon request	1
<b>Assemblies for signal transmission systems</b>								
70430249	10.0	13324535	•		6x2x0,25	695.0	Other lengths are available upon request	1
70430252	10.0	1995405		•	6x2x0,25	718.0	Other lengths are available upon request	1

Unless specified otherwise, the shown product values are nominal values. Detailed values (e.g. tolerances) are available upon request.  
Copper price basis: EUR 150/100kg. Refer to catalogue appendix T17 for the definition and calculation of copper-related surcharges.  
SEW® is a registered trademark of SEW Eurodrive GmbH & Co KG, Ernst-Blickle Str. 42, D-76646 Bruchsal  
Article numbers refer to genuine Lapp products.  
Photographs are not to scale and do not represent detailed images of the respective products.

**Assembled cables**

Servo applications - power drive systems



**Servo harnessing according to SIEMENS® 6FX5002-**



**Benefits**

- This cable is designed according to SIEMENS® standard. 6FX5002 is the high-quality, yet more economical, version of the highly flexible 6FX8002 version.
- 100% compatible with SIEMENS® systems
- The oil-resistant PVC sheath enables usage in industrial environments
- Fixed installation

**Application range**

- Plant engineering
- Servo drives and servo assemblies

**Product features**

- Design according to SIEMENS® standard 6FX 5002
- Outer sheath: special PVC compound, flame-retardant according to IEC 332.1,

**Note**

- Maximum cable length must comply with the specifications set by the manufacturer of the respective servo drives
- The technical data correspond to the cables used

**Design**

- Other versions and lengths can be delivered upon request.

**Technical data**



**Approvals**

Power cable:  
VDE-registered  
UL/CSA AWM Style 2570  
Signal cables:  
UL/CSA AWM style 2502



**Conductor stranding**

Extra-fine wire strand made of bare copper wires according to VDE 0295 class 6/IEC 60228 class 6



**Minimum bending radius**

Fixed installation: 5 x outer diameter  
Flexible use: 12 x outer diameter



**Nominal voltage**

Signal cables:  
- 30 V AC/DC (UL/CSA)  
- 30 V AC (IEC)  
Power cable:  
- Power cores:  
1000 V (UL/CSA)  
600/1000 V (IEC)  
- Control cores:  
750 V (UL/CSA)  
30 V AC (IEC)



**Temperature range**

Fixed installation: -20°C to +80°C  
Flexible use: 0°C to +60°C

Article number	Length (m)	SIEMENS® assembly designation	SIEMENS® cable designation	Copper index kg/1.000 pieces	Other dimensions	PU
<b>Assemblies for signal transmission systems</b>						
74305559	10.0	6FX5002-2AD00-1BA0	6FX5008-1BD41	630.0	Other lengths are available upon request	1
74305659	10.0	6FX5002-2AD04-1BA0	6FX5008-1BD41	630.0	Other lengths are available upon request	1
74305759	10.0	6FX5002-2AH00-1BA0	6FX5008-1BD21	770.0	Other lengths are available upon request	1
74305859	10.0	6FX5002-2CA11-1BA0	6FX5008-1BD21	770.0	Other lengths are available upon request	1
74306059	10.0	6FX5002-2CA31-1BA0	6FX5008-1BD51	690.0	Other lengths are available upon request	1
74306159	10.0	6FX5002-2CA34-1BA0	6FX5008-1BD51	690.0	Other lengths are available upon request	1
74306659	10.0	6FX5002-2CF01-1BA0	6FX5008-1BD41	630.0	Other lengths are available upon request	1
74306759	10.0	6FX5002-2CF02-1BA0	6FX5008-1BD41	630.0	Other lengths are available upon request	1
74306859	10.0	6FX5002-2CH00-1BA0	6FX5008-1BD41	630.0	Other lengths are available upon request	1
74307059	10.0	6FX5002-2EQ10-1BA0	6FX5008-1BD51	690.0	Other lengths are available upon request	1
74307159	10.0	6FX5002-2EQ14-1BA0	6FX5008-1BD51	690.0	Other lengths are available upon request	1
70430150	10.0	6FX5002-2DC00-1BA0	6FX2008-1DC00	370.0	Other lengths are available upon request	1
70430069	10.0	6FX5002-2DC10-1BA0	6FX2008-1DC00	370.0	Other lengths are available upon request	1
70430151	10.0	6FX5002-2DC20-1BA0	6FX2008-1DC00	370.0	Other lengths are available upon request	1
<b>Assemblies for motors without brake</b>						
74307259	10.0	6FX5002-5CA01-1BA0	6FX5008-1BB11	880.0	Other lengths are available upon request	1
74307459	10.0	6FX5002-5CA05-1BA0	6FX5008-1BB11	880.0	Other lengths are available upon request	1
74308259	10.0	6FX5002-5CA31-1BA0	6FX5008-1BB21	1,320.0	Other lengths are available upon request	1
74308559	10.0	6FX5002-5CA41-1BA0	6FX5008-1BB31	1,950.0	Other lengths are available upon request	1
74308659	10.0	6FX5002-5CA51-1BA0	6FX5008-1BB41	2,800.0	Other lengths are available upon request	1
70430003	10.0	6FX5002-5CS01-1BA0	6FX5008-1BB11	880.0	Other lengths are available upon request	1
70430004	10.0	6FX5002-5CS11-1BA0	6FX5008-1BB21	1,940.0	Other lengths are available upon request	1
<b>Assemblies for motors with brake</b>						
74308959	10.0	6FX5002-5DA01-1BA0	6FX5008-1BA11	1,500.0	Other lengths are available upon request	1
74309159	10.0	6FX5002-5DA05-1BA0	6FX5008-1BA11	1,430.0	Other lengths are available upon request	1
74309960	10.0	6FX5002-5DA31-1BA0	6FX5008-1BA21	1,940.0	Other lengths are available upon request	1
74313361	10.0	6FX5002-5DA41-1BA0	6FX5008-1BA31	2,720.0	Other lengths are available upon request	1
74313661	10.0	6FX5002-5DA51-1BA0	6FX5008-1BA41	3,510.0	Other lengths are available upon request	1
70430001	10.0	6FX5002-5DS01-1BA0	6FX5008-1BA11	1,500.0	Other lengths are available upon request	1
70430002	10.0	6FX5002-5DS11-1BA0	6FX5008-1BA21	1,940.0	Other lengths are available upon request	1

Unless specified otherwise, the shown product values are nominal values. Detailed values (e.g. tolerances) are available upon request.

Copper price basis: EUR 150/100kg. Refer to catalogue appendix T17 for the definition and calculation of copper-related surcharges.

Siemens part designations (6FX5002/5008, 6FX7002/7008, 6FX8002/8008) are registered trademarks of Siemens AG, and are listed for comparison purposes only. DESINA® is a registered trademark of the German Machine Tool Builders' Association.

Article numbers refer to genuine Lapp products.

Photographs are not to scale and do not represent detailed images of the respective products.





## Servo harnessing according to SIEMENS® 6FX 8002-



**Technical data**

**Classification**  
ETIM 5.0 Class-ID: EC000104  
ETIM 5.0 Class-Description: Control cable

**Approvals**  
Power cable:  
VDE-registered  
UL AWM Style 21223  
CSA AWM I/II, A/B 1000 V 80° FT 1  
Sensor leads: UL/CSA AWM Style 20236

**Minimum bending radius**  
Power cable:  
Fixed: 4 x D  
Dynamic: 1.5 mm² - 16 mm²: 7.5 x D  
25 mm² - 50 mm²: 10 x D  
Signal cable:  
Fixed: 4 x D  
Dynamic: 8 x D

**Nominal voltage**  
Signal cables:  
- 30 V AC/DC (UL/CSA)  
- 30 V AC (IEC)  
Power cable:  
- Power cores:  
600/1000 V (IEC)  
1000 V (UL/CSA)  
- Control cores:  
250 V AC (IEC)  
1000 V (UL/CSA)

**Temperature range**  
Fixed installation: -50°C to +80°C  
Flexing: -20°C to +60°C

- Benefits**
- Highly flexible servomotor and sensor cables that are designed for use in power chains
  - 100% compatible with SIEMENS® systems
  - The oil-resistant PUR sheath enables usage in industrial environments

- Application range**
- Plant engineering
  - Servo drives and servo assemblies

- Product features**
- Abrasion and cut-resistant, halogen-free, oil-resistant
  - Extra-fine strand made of copper wires:
    - > Signal cables: tinned
    - > Power cables: bare

- Design according to SIEMENS® standard 6FX 8002
- PUR outer sheath
- Signal cables: green (RAL 6018)
- Servo cable: orange (RAL 2003)

- Note**
- Please comply with the assembly guidelines for cables in power chain systems.
  - Maximum cable length must comply with the specifications set by the manufacturer of the respective servo drives
  - The technical data correspond to the cables used

- Design**
- Other versions and lengths can be delivered upon request.

Article number	Length (m)	SIEMENS® assembly designation	SIEMENS® cable designation	Copper index kg/1.000 pieces	Other dimensions	PU
<b>Assemblies for signal transmission systems</b>						
70301549	10.0	6FX8002-2AD00-1BA0	6FX8008-1BD41	660.0	Other lengths are available upon request	1
74303559	10.0	6FX8002-2AD04-1BA0	6FX8008-1BD41	660.0	Other lengths are available upon request	1
70389020	10.0	6FX8002-2AH00-1BA0	6FX8008-1BD41	770.0	Other lengths are available upon request	1
70301550	10.0	6FX8002-2CA11-1BA0	6FX8008-1BD21	770.0	Other lengths are available upon request	1
70301553	10.0	6FX8002-2CA31-1BA0	6FX8008-1BD51	860.0	Other lengths are available upon request	1
70301554	10.0	6FX8002-2CA34-1BA0	6FX8008-1BD51	860.0	Other lengths are available upon request	1
70301563	10.0	6FX8002-2CG00-1BA0	6FX8008-1BD21	770.0	Other lengths are available upon request	1
70301564	10.0	6FX8002-2CH00-1BA0	6FX8008-1BD41	660.0	Other lengths are available upon request	1
70301567	10.0	6FX8002-2EQ10-1BA0	6FX8008-1BD51	860.0	Other lengths are available upon request	1
70391522	10.0	6FX8002-2EQ14-1BA0	6FX8008-1BD51	860.0	Other lengths are available upon request	1
70301568	10.0	6FX8002-2CF01-1BA0	6FX8008-1BD41	660.0	Other lengths are available upon request	1
70301569	10.0	6FX8002-2CF02-1BA0	6FX8008-1BD41	660.0	Other lengths are available upon request	1
70301575	10.0	6FX8002-4AA21-1BA0	6FX8008-1BD61	540.0	Other lengths are available upon request	1
70430149	10.0	6FX8002-2DC00-1BA0	6FX8008-2DC00	410.0	Other lengths are available upon request	1
70431018	10.0	6FX8002-2DC10-1BA0	6FX8008-2DC00	410.0	Other lengths are available upon request	1
70430096	10.0	6FX8002-2DC20-1BA0	6FX8008-2DC00	410.0	Other lengths are available upon request	1
<b>Assemblies for motors without brake</b>						
70301578	10.0	6FX8002-5CA01-1BA0	6FX8008-1BB11	840.0	Other lengths are available upon request	1
70301601	10.0	6FX8002-5CA05-1BA0	6FX8008-1BB11	900.0	Other lengths are available upon request	1
70301583	10.0	6FX8002-5CA31-1BA0	6FX8008-1BB21	1,350.0	Other lengths are available upon request	1
70301585	10.0	6FX8002-5CA41-1BA0	6FX8008-1BB31	2,060.0	Other lengths are available upon request	1
70301586	10.0	6FX8002-5CA51-1BA0	6FX8008-1BB41	2,710.0	Other lengths are available upon request	1
70430007	10.0	6FX8002-5CS01-1BA0	6FX8008-1BB11	960.0	Other lengths are available upon request	1
70430008	10.0	6FX8002-5CS11-1BA0	6FX8008-1BB21	1,280.0	Other lengths are available upon request	1
<b>Assemblies for motors with brake</b>						
70301588	10.0	6FX8002-5DA01-1BA0	6FX8008-1BA11	1,430.0	Other lengths are available upon request	1
70301600	10.0	6FX8002-5DA05-1BA0	6FX8008-1BA11	1,430.0	Other lengths are available upon request	1
70301594	10.0	6FX8002-5DA31-1BA0	6FX8008-1BA21	1,860.0	Other lengths are available upon request	1
70301597	10.0	6FX8002-5DA41-1BA0	6FX8008-1BA31	2,610.0	Other lengths are available upon request	1
70301598	10.0	6FX8002-5DA51-1BA0	6FX8008-1BA41	3,300.0	Other lengths are available upon request	1
70430005	10.0	6FX8002-5DS01-1BA0	6FX8008-1BA11	1,430.0	Other lengths are available upon request	1
70430006	10.0	6FX8002-5DS11-1BA0	6FX8008-1BA21	1,870.0	Other lengths are available upon request	1

Unless specified otherwise, the shown product values are nominal values. Detailed values (e.g. tolerances) are available upon request.  
Copper price basis: EUR 150/100kg. Refer to catalogue appendix T17 for the definition and calculation of copper-related surcharges.  
Siemens part designations (6FX5002/5008, 6FX7002/7008, 6FX8002/8008) are registered trademarks of Siemens AG, and are listed for comparison purposes only. DESINA® is a registered trademark of the German Machine Tool Builders' Association.  
Article numbers refer to genuine Lapp products.  
Other designs and lengths are available upon request.  
Photographs are not to scale and do not represent detailed images of the respective products.

**Assembled cables**

Servo applications - power drive systems



## Servo harnessing according to INDRAMAT® IKG / RKL



**Benefits**

- Highly flexible servomotor cables that are designed for use in power chains.
- 100% compatible with INDRAMAT® systems
- The oil-resistant PUR sheath enables usage in industrial environments

**Application range**

- Plant engineering
- Servo drives and servo assemblies

**Product features**

- In accordance with INDRAMAT® standard IKG/RKL

**Note**

- Please comply with the assembly guidelines for cables in power chain systems.
- Maximum cable length must comply with the specifications set by the manufacturer of the respective servo drives
- The technical data correspond to the cables used

**Design**

- Other versions and lengths can be delivered upon request.

**Technical data**

- Classification**  
ETIM 5.0 Class-ID: EC000104  
ETIM 5.0 Class-Description: Control cable
- Approvals**  
UL/CSA AWM Style 20234
- Minimum bending radius**  
Fixed installation: 6 x outer diameter  
Flexible use: 10 x outer diameter
- Nominal voltage**  
Power cores:  
- 1000 V (UL/CSA)  
- 600/1000 V (IEC)  
Control cores:  
250 V AC (IEC)  
1000 V (UL/CSA)
- Temperature range**  
Fixed installation: -50°C to +80°C  
Flexible: -30 °C to +60 °C

Article number	Length (m)	INDRAMAT® ordering designation	Cable designation	Copper index kg/1.000 pieces	Other dimensions	PU
<b>Assemblies to INDRAMAT® standard IKG</b>						
70345476	10.0	IKG4009-010	INK0653	1,700.0	Other lengths are available upon request	1
70345503	10.0	IKG4087-010	INK0603	3,060.0	Other lengths are available upon request	1
70345521	10.0	IKG4163-010	INK0605	5,650.0	Other lengths are available upon request	1
70345522	10.0	IKG4170-010	INK0605	5,650.0	Other lengths are available upon request	1
70345541	10.0	IKG4020-010	INK0653	1,700.0	Other lengths are available upon request	1
70345542	10.0	IKG4018-010	INK0653	1,700.0	Other lengths are available upon request	1
70345543	10.0	IKG4016-010	INK0653	1,700.0	Other lengths are available upon request	1
70345545	10.0	IKG4050-010	INK0650	1,890.0	Other lengths are available upon request	1
<b>Assemblies to INDRAMAT® standard RKL</b>						
70410000	10.0	RKL4330-010	INK0606	6,700.0	Other lengths are available upon request	1
70392839	10.0	RKL4302-010	INK0653	1,700.0	Other lengths are available upon request	1
70410001	10.0	RKL4303-010	INK0653	1,700.0	Other lengths are available upon request	1

Unless specified otherwise, the shown product values are nominal values. Detailed values (e.g. tolerances) are available upon request.  
 Copper price basis: EUR 150/100kg. Refer to catalogue appendix T17 for the definition and calculation of copper-related surcharges.  
 Indramat part designations (IKG, IKS, INK, INS, RKL and RKG) are registered trademarks of Bosch Rexroth AG, and are listed for comparison purposes only.  
 Article numbers refer to genuine Lapp products.  
 Other designs and lengths are available upon request.  
 Photographs are not to scale and do not represent detailed images of the respective products.



## Servo harnessing according to INDRAMAT® IKS / RKG



### Benefits

- Highly flexible feedback cables that are designed for use in power chains
- 100% compatible with INDRAMAT® systems
- The oil-resistant PUR sheath enables usage in industrial environments

### Application range

- Plant engineering
- Servo drives and servo assemblies

### Product features

- In accordance with INDRAMAT® standard IKS/RKG

### Note

- Please comply with the assembly guidelines for cables in power chain systems.
- Maximum cable length must comply with the specifications set by the manufacturer of the respective servo drives
- The technical data correspond to the cables used

### Design

- Other versions and lengths can be delivered upon request.

### Technical data

**Classification**  
 ETIM 5.0 Class-ID: EC000104  
 ETIM 5.0 Class-Description: Control cable

**Approvals**  
 UL/CSA AWM Style 20236

**Minimum bending radius**  
 Fixed installation: 5 x outer diameter  
 Flexible use: 10 x outer diameter

**Nominal voltage**  
 300 V

**Temperature range**  
 Fixed installation: -30 °C to +90 °C  
 Flexible: -30 °C to +80 °C

Article number	Length (m)	INDRAMAT® ordering designation	Cable designation	Copper index kg/ 1.000 pieces	Other dimensions	PU
<b>Assemblies to INDRAMAT® standard IKS</b>						
70335583	10.0	IKS4374-010	INK0448	600.0	Other lengths are available upon request	1
70335584	10.0	IKS4376-010	INK0448	700.0	Other lengths are available upon request	1
70335595	10.0	IKS4103-010	INK0448	700.0	Other lengths are available upon request	1
70335596	10.0	IKS4153-010	INK0448	700.0	Other lengths are available upon request	1
<b>Assemblies to INDRAMAT® standard RKG</b>						
70392984	10.0	RKG4200-010	INK0448	600.0	Other lengths are available upon request	1
70410002	10.0	RKG4201-010	INK0448	600.0	Other lengths are available upon request	1

Unless specified otherwise, the shown product values are nominal values. Detailed values (e.g. tolerances) are available upon request.

Copper price basis: EUR 150/100kg. Refer to catalogue appendix T 17 for the definition and calculation of copper-related surcharges.

Indramat part designations (IKG, IKS, INK, INS, RKL and RKG) are registered trademarks of Bosch Rexroth AG, and are listed for comparison purposes only.

Article numbers refer to genuine Lapp products.

Other designs and lengths are available upon request.

Photographs are not to scale and do not represent detailed images of the respective products.

Assembled cables

Servo applications - power drive systems



Servo harnessing according to LENZE®



Benefits

- Servomotors, resolvers and encoder cables for fixed installation or application in power supply chains
- 100% compatible with specific drive systems
- Outer sheath makes them particularly suitable for use in industrial areas

Application range

- Plant engineering
- Servo drives and servo assemblies

Product features

- Design according to specific drive systems:
- Designs for fixed installation: PVC outer sheath, flame-retardant in accordance with IEC 332.1, UL/CSA-approved PP core insulation.
- Designs for highly flexible use: oil-resistant PUR sheath in accordance with VDE472-803 Part B, flame-retardant in accordance with IEC 60332.1-2, TPE core insulation.

Note

- For the highly flexible version, please observe the assembly guidelines for cables in power chain systems.
- Maximum cable length must comply with the specifications set by the manufacturer of the respective servo drives
- The technical data correspond to the cables used

Design

- Other versions and lengths can be delivered upon request.

Technical data



Classification

ETIM 5.0 Class-ID: EC000104  
ETIM 5.0 Class-Description:  
Control cable



Approvals

Resolver and encoder cable:  
UL AWM Style 2464 for fixed installation versions, Style 21165 for highly flexible applications.  
Motor cable:  
UL AWM Style 2570 for fixed installation version; Style 20940 for high flexibility use.



Minimum bending radius

Fixed installation: 7.5 x outer diameter  
Flexible use: 10 x outer diameter



Nominal voltage

Resolver and encoder cable:  
30 V (VDE), 300 V (UL/CSA)  
Resolver and encoder cable:  
30 V (VDE), 300 V (UL/CSA)



Test voltage

Resolver and encoder cable: 1.5 kV  
Motor cable:  
- Power cores: 4 kV  
- Control cores: 2 kV



Temperature range

Fixed installation: -25°C to +80°C  
Flexible use: -5°C to +70°C

Article number	Length (m)	LENZE® item designation	Static	Highly flexible	Number of cores and mm <sup>2</sup> per conductor	Copper index kg/1.000 pieces	Other dimensions	PU
<b>Servo cables</b>								
74320320	10.0	EWLM-010GM-015	•		4 G 1,5+(2x0,5)	1,060.0	Other lengths are available upon request	1
74320499	10.0	EWLM-010GM-025	•		4 G 2,5+(2x0,5)	1,560.0	Other lengths are available upon request	1
74321272	10.0	EWLM-010GMS-015		•	4 G 1,5+(2x0,5)	1,060.0	Other lengths are available upon request	1
74321426	10.0	EWLM-010GMS-025		•	4 G 2,5+(2x0,5)	1,530.0	Other lengths are available upon request	1
70415002	10.0	EYP-0003-A-0100-M01-A00	•		4 G 1.5	1,060.0	Other lengths are available upon request	1
<b>Fan cables</b>								
74322480	10.0	EWLL-010GM	•		5 G 0.5	240.0	Other lengths are available upon request	1
74322629	10.0	EWLL-010GMS		•	5 G 0.5	240.0	Other lengths are available upon request	1
70415001	10.0	EYL-0001-V-0100L02-J02		•	5 G 0.75	360.0	Other lengths are available upon request	1
<b>Resolver cables</b>								
74320540	10.0	EWLR-010GM-T	•		3x (2x0,14) + 1x (2x0,5)	430.0	Other lengths are available upon request	1
74323073	10.0	EWLR-010GMS-T		•	3x (2x0,14) + 1x (2x0,5)	430.0	Other lengths are available upon request	1
70415005	10.0	EYF-0020-A-0100-F01-S04		•	3x (2x0,14) + 3x 0,14	370.0	Other lengths are available upon request	1
<b>Encoder cables</b>								
74323522	10.0	EWLE-010GM-T	•		4x (2x0,14) + 1x (2x1,0)	650.0	Other lengths are available upon request	1
74323672	10.0	EWLE-010GMS-T		•	4x (2x0,14) + 1x (2x1,0)	650.0	Other lengths are available upon request	1

Unless specified otherwise, the shown product values are nominal values. Detailed values (e.g. tolerances) are available upon request.

Copper price basis: EUR 150/100kg. Refer to catalogue appendix T17 for the definition and calculation of copper-related surcharges.

Lenze® part designations (EWLM\_, EWLR\_, EWLE\_, EWLL\_, EYL und EYP) are registered trademarks of Lenze® AG, and are listed for comparison purposes only. DESINA® is a registered trademark of the German Machine Tool Builders' Association.

Article numbers refer to genuine Lapp products.

Photographs are not to scale and do not represent detailed images of the respective products.





## ÖLFLEX® SERVO FD 796 CP

High-end servo cable, screened

LAPP KABEL STUÏGART ÖLFLEX® SERVO FD 796 CP CE



Info

- Extended Line for heavy duty in power chain applications
- EMC-compliant

### Benefits

- Allows much faster speed and accelerations which increases the economic efficiency of the machines
- Multi-standard = fewer part varieties = cost savings
- Suitable for use with servomotor drives from leading manufacturers
- To substitute 7 ÖLFLEX® SERVO FD product lines:  
755CP/-755CP DESINA/-781CP/-785CP/-785CP DESINA/-790CP/-795CP

### Application range

- Connecting cable between servo controller and motor
- In power chains or moving machine parts
- For use in assembling & pick-and-place machinery
- Particularly in wet areas of machine tools and transfer lines
- Assembly lines, production lines, in all kinds of machines

### Product features

- Dynamic performance in power chains: Acceleration up to 50 m/s<sup>2</sup>. Travel speeds up to 5 m/s. Travel distances up to 100 m.
- Low-capacitance design
- Halogen-free materials
- Flame retardancy: UL/CSA: VW-1, FT1 IEC/EN: 60332-1-2
- Oil-resistant

### Norm references / Approvals

- VDE - Reg. - No. 8591  
UL AWM Style 20234  
CSA AWM I/II, A 1000V 80° FT 1
- For use in power chains: Please comply with the assembly guidelines listed in Appendix T3
- UL File No. E63634

### Design

- Extra-fine wire strand made of bare copper wires (class 6)
- Core insulation: polypropylene (PP)
- Individual design depending on the item: power cores with or without one pair, or with two control core pairs, in pairs, with screening, twisted together in short lay lengths
- Non-woven wrapping
- Tinned-copper braiding
- PUR outer sheath, orange (RAL 2003)

### Technical data

- Classification**  
ETIM 5.0 Class-ID: EC000104  
ETIM 5.0 Class-Description: Control cable
- Core identification code**  
Power: black cores with marking U/L1/C/L+; V/L2; W/L3/D /L- and 1 green-yellow core  
Optional designs with one pair of control cores: black; white  
Two pairs of control cores: black with white numbers: 5, 6, 7, 8
- Specific insulation resistance**  
> 20 GOhm x cm
- Conductor stranding**  
Extra-fine wire according to VDE 0295, class 6/IEC 60228 class 6
- Minimum bending radius**  
For flexible use:  
7.5 x outer diameter (1.5-16 mm<sup>2</sup>)  
10 x outer diameter (25-50 mm<sup>2</sup>)  
Fixed installation: 4 x outer diameter
- Nominal voltage**  
VDE: power cores and control cores: U<sub>0</sub>/U: 600/1000 V  
UL & CSA: 1000 V
- Test voltage**  
Core/Core: 4 kV  
Core/Screen: 4 kV
- Protective conductor**  
G = with GN-YE protective conductor
- Temperature range**  
Flexing: -40°C to +90°C  
(UL/CSA: +80°C)  
Fixed installation: -50°C to +90°C  
(UL/CSA: +80°C)

Article number	Number of cores and mm <sup>2</sup> per conductor	Outer diameter (mm)	Copper index (kg/km)	Weight (kg/km)
<b>ÖLFLEX® SERVO FD 796 CP</b>				
0027950	4 G 1,5	9.1	79.0	140
0027951	4 G 2,5	10.6	129.0	197
0027952	4 G 4	11.9	186.0	268
0027953	4 G 6	14.5	296.0	397
0027954	4 G 10	17.5	449.0	591
0027955	4 G 16	21.6	716.0	955
0027956	4 G 25	25.2	1,073.0	1337
0027957	4 G 35	28.6	1,480.0	1769
0027958	4 G 50	33.4	2,115.0	2468
0027959	4 G 1,5 + (2 x 1,5)	11.6	135.0	261
0027960	4 G 2,5 + (2 x 1,5)	13.4	188.0	318
0027961	4 G 4 + (2 x 1,5)	14.8	235.0	385
0027962	4 G 6 + (2 x 1,5)	16.8	329.0	486
0027963	4 G 10 + (2 x 1,5)	19.4	515.0	701

Article number	Number of cores and mm <sup>2</sup> per conductor	Outer diameter (mm)	Copper index (kg/km)	Weight (kg/km)
0027964	4 G 16 + (2 x 1,5)	23.1	757.0	1048
0027965	4 G 25 + (2 x 1,5)	26.6	1,147.0	1532
0027966	4 G 35 + (2 x 1,5)	30.9	1,538.0	2097
0027967	4 G 50 + (2 x 1,5)	34.0	2,181.0	2721
0027969	4 G 1,5 + 2 x (2 x 0,75)	12.2	159.0	313
0027970	4 G 2,5 + 2 x (2 x 1,0)	14.6	207.0	395
0027980	4 G 4 + 2 x (2 x 1,0)	16.1	274.0	466
0027971	4 G 4 + (2 x 1,0) + (2 x 1,5)	16.3	344.0	485
0027972	4 G 6 + (2 x 1,0) + (2 x 1,5)	18.1	436.0	588
0027973	4 G 10 + (2 x 1,0) + (2 x 1,5)	21.8	610.0	819
0027974	4 G 16 + 2 x (2 x 1,5)	25.5	801.0	1135
0027975	4 G 25 + 2 x (2 x 1,5)	28.8	1,187.0	1559
0027976	4 G 35 + 2 x (2 x 1,5)	30.9	1,588.0	2093
0027977	4 G 50 + 2 x (2 x 2,5)	36.3	2,557.0	2920

Unless specified otherwise, the shown product values are nominal values. Detailed values (e.g. tolerances) are available upon request. Please find our standard lengths at: [www.lappkabel.de/en/cable-standardlengths](http://www.lappkabel.de/en/cable-standardlengths)  
Photographs are not to scale and do not represent detailed images of the respective products.

### Accessories

- Circular connectors refer to page 256
- SKINTOP® EMC/Earthing refer to page 263

**Power chain applications**

Servo applications - power drive systems, approved



**New**

**ÖLFLEX® SERVO FD 798 CP**

High-end resolver/encoder cable, screened

LAPP KABEL STUÏGART ÖLFLEX® SERVO FD 798 CP



Info

- Extended Line for heavy duty in power chain applications
- EMC-compliant

**Benefits**

- Thin, optimised for weight and volume
- Also suitable for mobile outdoor use
- Suitable for use with encoders & resolvers from leading manufacturers
- To substitute 4 ÖLFLEX® SERVO FD product lines: -760CP/-760CP DESINA®/-770CP/ -770CP DESINA®

**Application range**

- Connecting cable between servo controller and encoder/resolver
- Connecting cable between servo controller and speed generators
- In power chains or moving machine parts
- Particularly in wet areas of machine tools and transfer lines
- Assembly lines, production lines, in all kinds of machines

**Product features**

- Dynamic performance in power chains: Acceleration up to 50 m/s<sup>2</sup>. Travel speeds up to 5 m/s. Travel distances up to 100 m.
- Low-capacitance design
- Halogen-free materials
- Flame retardancy: UL/CSA: VW-1, FT1 IEC/EN: 60332-1-2
- Oil-resistant

**Norm references / Approvals**

- UL AWM Style 20236
- CSA AWM IA/B; IIA/B FT 1
- For use in power chains: Please comply with the assembly guidelines listed in Appendix T3
- UL File No. E63634

**Design**

- Fine-wire or extra-fine wire, tinned-copper conductor
- Core insulation: polypropylene (PP)
- Cores (or core pairs) twisted in layers or bundles
- Refer to data sheet for more details
- Non-woven wrapping
- PUR outer sheath, green (RAL 6018)

**Technical data**



**Classification**

ETIM 5.0 Class-ID: EC000104  
ETIM 5.0 Class-Description: Control cable



**Core identification code**

Details see datasheet ÖLFLEX® SERVO FD 798 CP



**Specific insulation resistance**

> 20 GOhm x cm



**Conductor stranding**

Fine wire or extra-fine wire



**Minimum bending radius**

Flexible use: 7.5 x outer diameter  
Fixed installation: 4 x outer diameter



**Nominal voltage**

IEC: 30 V  
UL & CSA: 30 V



**Test voltage**

Core/core: 1500 V rms  
Core/screen: 750 V rms



**Temperature range**

Flexing: -40°C to +90°C (UL/CSA: +80°C)  
Fixed installation: -50°C to +90°C (UL/CSA: +80°C)

Article number	Number of cores and mm <sup>2</sup> per conductor	Outer diameter (mm)	Copper index (kg/km)	Weight (kg/km)
<b>ÖLFLEX® SERVO FD 798 CP</b>				
0036910	4x2x0,34+4x0,5	8.9	79.0	125
0036911	3x(2x0,14)+2x(0,5)	8.9	70.0	120
0036912	3x(2x0,14)+4x0,14+2x0,5	8.8	68.0	110
0036913	3x(2x0,14)+4x0,14+2x0,5+4x0,22	9.4	80.0	130
0036914	9x0,5	8.8	71.0	110
0036915	4x2x0,25+2x1,0	8.8	63.0	109
0036916	6x2x0,25+2x0,5	10.3	67.0	121
0036917	10x0,14+2x0,5	7.7	41.0	82
0036918	10x0,14+4x0,5	8.1	54.0	98
0036920	4x2x0,14+4x0,5	8.2	51.0	95
0036921	4x2x0,25	7.6	38.0	75
0036923	8x2x0,18	7.8	51.0	85
0036924	4x2x0,18	6.4	30.0	52
0036926	12x0,22	6.9	44.0	73
0036927	4x2x0,25+2x0,5	8.5	62.0	98
0036928	2x2x0,14+2x(2x0,14)+4x0,5+(4x0,14)	9.1	79.0	135
0036929	2x(2x0,25)+2x0,5	8.7	46.0	98
0036930	2x2x0,25+2x0,5	7.3	38.0	72

Unless specified otherwise, the shown product values are nominal values. Detailed values (e.g. tolerances) are available upon request. Copper price basis: EUR 150/100kg. Refer to catalogue appendix T17 for the definition and calculation of copper-related surcharges.

Please find our standard lengths at: [www.lappkabel.de/en/cable-standardlengths](http://www.lappkabel.de/en/cable-standardlengths)

Packaging size: coil ≤ 30 kg or ≤ 250 m, otherwise drum

Please specify the preferred type of packaging (e.g. 1 x 500 m drum or 5 x 100 m coils).

DESINA® is a registered trademark of the German Machine Tool Builders' Association

Photographs are not to scale and do not represent detailed images of the respective products.

**Accessories**

- Circular connectors refer to page 256
- SILVYN® CHAIN cable protection and guiding systems



**New**

# ÖLFLEX® SERVO FD 7DSL / ÖLFLEX® SERVO 7DSL

Hybrid cables



**Info**

- Suitable for Hiperface DSL® motor-feedback systems
- EMC-compliant



**Benefits**

- Less cables and reduced connection costs
- Only one connection line between drive and motor-feedback system
- Multi-standard = fewer part varieties = cost savings
- Easy to install

**Application range**

- Power drive systems in automation engineering
- Connecting cable between servo controller and motor
- In power chain applications (FD version) or for fixed installation
- For use in assembling & pick-and-place machinery
- Particularly in wet areas of machine tools and transfer lines

**Product features**

- Low-adhesive surface
- Flame retardancy: UL/CSA: VW-1, FT1 IEC/EN: 60332-1-2
- Oil-resistant
- Low-capacitance design

**Norm references / Approvals**

- UL-AWM-Style 21223 (highly flexible use) UL-AWM-Style 2570 (fixed installation design) cRU AWM I/II A/B FT1
- Designs for power chain use: Travel distances up to 20m (horizontal)
- For use in power chains: Please comply with the assembly guidelines listed in Appendix T3
- UL File No. E63634

**Design**

- Design for highly flexible use: Polypropylen (PP) core insulation, PUR outer sheath, halogen-free
- Design for fixed installation: Polypropylen (PP) core insulation, PVC outer sheath
- Refer to data sheet (available upon request) for more details
- Outer sheath colour: Orange (RAL 2003)

**Technical data**

- Classification**  
ETIM 5.0 Class-ID: EC000104  
ETIM 5.0 Class-Description: Control cable
- Core identification code**  
Power: black cores with marking U/L1/C/L+; V/L2; W/L3/D /L- and 1 green-yellow core  
Signal pair: white, blue  
Control pair (optional): black with white numbers 5,6
- Specific insulation resistance**  
> 20 GOhm x cm
- Minimum bending radius**  
For flexible use: 7.5 x outer diameter  
Fixed installation: 5 x outer diameter
- Nominal voltage**  
Power and control: IEC: U<sub>0</sub>/U: 600/1000 V  
UL: 1000 V  
Signal pair: 300 V
- Test voltage**  
Power and control: 4 kV  
Signal pair: 1kV
- Protective conductor**  
G = with GN-YE protective conductor
- Temperature range**  
Flexing: -40°C to +90°C (UL: +80°C)  
Fixed installation: -40°C to +70°C (UL: +80°C)

Article number	Number of cores and mm <sup>2</sup> per conductor	Outer diameter (mm)	Copper index (kg/km)	Weight (kg/km)
<b>Hybrid cables for power chain applications</b>				
1023275	4 G 1,5 + (2 x 22AWG)	11.2	115.0	198
1023276	4 G 2,5 + (2 x 22AWG)	12.6	160.0	269
1023277	4 G 4 + (2 x 22AWG)	14.0	218.0	343
1023278	4 G 1,5 + (2 x 1,0) + (2 x 22AWG)	13.2	152.0	256
1023279	4 G 2,5 + (2 x 1,0) + (2 x 22AWG)	14.0	195.0	313
1023280	4 G 4 + (2 x 1,0) + (2 x 22AWG)	15.8	268.0	407
<b>Hybrid cables for fixed installation</b>				
1023290	4 G 1,5 + (2 x 22AWG)	11.2	110.0	194
1023291	4 G 2,5 + (2 x 22AWG)	12.6	148.0	253
1023292	4 G 4 + (2 x 22AWG)	14.0	208.0	332
1023293	4 G 1,5 + (2 x 1,0) + (2 x 22AWG)	13.2	140.0	250
1023294	4 G 2,5 + (2 x 1,0) + (2 x 22AWG)	14.0	185.0	285
1023295	4 G 4 + (2 x 1,0) + (2 x 22AWG)	15.8	248.0	390

Unless specified otherwise, the shown product values are nominal values. Detailed values (e.g. tolerances) are available upon request. Please find our standard lengths at: [www.lappkabel.de/en/cable-standardlengths](http://www.lappkabel.de/en/cable-standardlengths)  
HIPERFACE DSL® is a registered trademark of SICK AG  
Photographs are not to scale and do not represent detailed images of the respective products.

**Similar products**

- ÖLFLEX® SERVO FD 796 CP refer to page 13

**Accessories**

- Protective cable conduit systems and cable carrier systems refer to page
- Circular connectors refer to page 256

**Servo applications**

PVC sheath, approved



**SERVO Cables in acc. to SEW® Standard**

Servo cable, approved



**Info**

- Servo drives
- EMC-compliant

**Benefits**

- Multi-standard = fewer part varieties = cost savings

**Application range**

- Specially designed to connect SEW servo-motors
- Connecting cable between servo controller and motor
- Plant engineering
- Machine tools
- Printing machines

**Product features**

- For fixed installation or applications with occasional movements
- Oil-resistant
- Flame-retardant according IEC 60332-1-2
- Flame-retardant according to UL VW1/CSA FT1

**Norm references / Approvals**

- UL-AWM-Style 2570
- Based on VDE 0250 / 0285
- UL File No. E63634

**Design**

- Fine-wire strand made of bare copper wires
- Core insulation: TPE
- Control core triplet with laminated aluminium film and a layer of tinned-copper wires
- Cores twisted in short lay lengths
- Tinned-copper braiding
- PVC outer sheath, orange (RAL 2003)

**Technical data**

- Core identification code**  
Power: black cores with U, VV, WWW printing and 1 core gnye  
Control cores: black cores with numbers 1, 2 and 3
- Specific insulation resistance**  
> 20 GOhm x cm
- Conductor stranding**  
Fine wire according to VDE 0295 Class 5/ IEC 60228 Class 5
- Minimum bending radius**  
Occasional flexing: 15 x outer diameter  
Fixed installation: 4 x outer diameter
- Nominal voltage**  
Power cores: IEC 750 V, UL 600 V  
Control cores: 1 mm<sup>2</sup> and 1.5 mm<sup>2</sup>: IEC 350 V, UL 600 V
- Test voltage**  
2000 V
- Protective conductor**  
G = with GN-YE protective conductor
- Temperature range**  
Flexing: -10°C to +80°C  
Fixed installation: -40°C to +80°C

Article number	Number of cores and mm <sup>2</sup> per conductor	Outer diameter (mm)	Copper index (kg/km)	Weight (kg/km)
<b>Servo cables</b>				
0038060	4 G 1,5 + (3 x 1,0)	11.8	151.0	300
0038061	4 G 2,5 + (3 x 1,0)	13.4	212.9	370
0038062	4 G 4 + (3 x 1,0)	15.0	281.8	476
0038063	4 G 6 + (3 x 1,5)	17.0	392.8	625
0038064	4 G 10 + (3 x 1,5)	20.0	625.1	1024

Unless specified otherwise, the shown product values are nominal values. Detailed values (e.g. tolerances) are available upon request.  
Copper price basis: EUR 150/100kg. Refer to catalogue appendix T17 for the definition and calculation of copper-related surcharges.  
Please find our standard lengths at: [www.lappkabel.de/en/cable-standardlengths](http://www.lappkabel.de/en/cable-standardlengths)  
Packaging size: coil ≤ 30 kg or ≤ 250 m, otherwise drum  
Please specify the preferred type of packaging (e.g. 1 x 500 m drum or 5 x 100 m coils).  
SEW® is a registered trademark of SEW Eurodrive GmbH & Co KG, Ernst-Blickle Str. 42, D-76646 Bruchsal  
Photographs are not to scale and do not represent detailed images of the respective products.

**Accessories**

- SKINTOP® MS-SC-M refer to page 263
- SKINTOP® MS-M BRUSH refer to page 264





## SERVO cables in acc. to SIEMENS® Standard 6FX 5008- Motor and resolver/encoder cables

**Info**

- Servo drives
- EMC-compliant



**Benefits**

- New motor & servomotor cables up to 6 mm<sup>2</sup>: low capacitance characteristics due to PP insulation
- Multi-standard = fewer part varieties = cost savings

**Application range**

- Servo applications - power drive systems
- Plant engineering
- Machine tool manufacture
- Printing machines

**Product features**

- Oil-resistant
- Flame-retardant according to IEC 60332-1-2 & CSA FT1

**Norm references / Approvals**

- Power cable: VDE-registered UL/CSA AWM Style 2570
- Signal cables: UL/CSA AWM style 2502
- UL File No. E63634

**Design**

- Design according to SIEMENS® standard 6FX 5008
- Core insulation: up to 6 mm<sup>2</sup> = PP; 10 mm<sup>2</sup> and larger = PVC
- Core and pairs are twisted together
- Tinned-copper braiding
- Outer sheath made of special PVC compound
- Signal cables: green (RAL 6018)
- Motor and servomotor cables: orange (RAL 2003)

**Technical data**

**Classification**  
ETIM 5.0 Class-ID: EC000104  
ETIM 5.0 Class-Description: Control cable

**Conductor stranding**  
Fine wire according to VDE 0295, class 5/IEC 60228 class 5

**Minimum bending radius**  
For fixed installation: 5 x outer diameter  
For flexible use: 15 x outer diameter

**Nominal voltage**  
Signal cables:  
- 30 V AC/DC (UL/CSA)  
- 30 V AC (IEC)  
Power cable:  
- Power cores: 1000 V (UL/CSA) 600/1000 V (IEC)  
- Control cores: 1000 V (UL/CSA) 30 V AC (IEC)

**Test voltage**  
Power cable:  
Power cores: 4000 V eff.  
Control cores: 2000 V eff.  
Signal cables: 500 V rms

**Temperature range**  
Fixed installation: -20°C to +80°C  
Flexing: from -0°C to +60°C

Article number	Number of cores and mm <sup>2</sup> per conductor	Reference article no.	Outer diameter (mm)	Copper index (kg/km)	Weight (kg/km)
<b>Signal cables</b>					
0025724	4 x 2 x 0,38 + 4 x 0,5	6FX5008-1BD21	9.0	76.4	120
0025725	3 x (2 x 0,14) + 4 x 0,14 + 2 x 0,5	6FX5008-1BD41	8.9	63.0	100
0025726	3 x (2 x 0,14) + 4 x 0,14 + 2 x 0,5 + 4 x 0,23	6FX5008-1BD51	9.5	69.0	139
<b>Motor cables</b>					
00257001	4 G 1.5	6FX5008-1BB11 LC	8.0	88.0	131
00257011	4 G 2.5	6FX5008-1BB21 LC	9.6	132.0	219
00257021	4 G 4	6FX5008-1BB31 LC	11.0	195.0	312
00257031	4 G 6	6FX5008-1BB41 LC	13.1	280.0	380
0025704	4 G 10	6FX5008-1BB51	19.3	445.0	620
0025705	4 G 16	6FX5008-1BB61	23.3	715.0	1060
0025706	4 G 25	6FX5008-1BB25	26.9	1,110.0	1640
0025707	4 G 35	6FX5008-1BB35	30.3	1,540.0	2310
0025708	4 G 50	6FX5008-1BB50	36.5	2,160.0	3240
<b>Servo cables</b>					
00257151	4 G 1,5 + (2 x 1,5)	6FX5008-1BA11 LC	10.4	150.0	248
00257161	4 G 2,5 + (2 x 1,5)	6FX5008-1BA21 LC	12.0	194.0	310
00257171	4 G 4 + (2 x 1,5)	6FX5008-1BA31 LC	13.6	272.0	445
00257181	4 G 6 + (2 x 1,5)	6FX5008-1BA41 LC	15.6	351.0	554
0025719	4 G 10 + (2 x 1,5)	6FX5008-1BA51	21.0	536.0	806

Unless specified otherwise, the shown product values are nominal values. Detailed values (e.g. tolerances) are available upon request.

Copper price basis: EUR 150/100kg. Refer to catalogue appendix T17 for the definition and calculation of copper-related surcharges.

Please find our standard lengths at: [www.lappkabel.de/en/cable-standardlengths](http://www.lappkabel.de/en/cable-standardlengths)

Packaging size: coil ≤ 30 kg or ≤ 250 m, otherwise drum

Please specify the preferred type of packaging (e.g. 1 x 500 m drum or 5 x 100 m coils).

Siemens part designations (6FX5002/5008, 6FX7002/7008, 6FX8002/8008) are registered trademarks of Siemens AG, and are listed for comparison purposes only. DESINA® is a registered trademark of the German Machine Tool Builders' Association.

Article numbers refer to genuine Lapp products.

Photographs are not to scale and do not represent detailed images of the respective products.

**Similar products**

- ÖLFLEX® SERVO FD 796 CP refer to page 13
- SERVO cables in acc. to SIEMENS® Standard 6FX 8PLUS refer to page 18

**Accessories**

- Circular connectors refer to page 256
- SKINTOP® EMC/Earthing refer to page 263

**Power chain applications**

Servo applications - power drive systems, approved



**SERVO cables in acc. to SIEMENS® Standard 6FX 8PLUS**

**Motor and resolver/encoder cables**



**Info**

- Extended Line for heavy duty in power chain applications
- EMC-compliant

**Benefits**

- Allows much faster speed and accelerations which increases the economic efficiency of the machines
- Multi-standard = fewer part varieties = cost savings

**Application range**

- Connecting cable between servo controller and encoder/resolver
- Connecting cable between servo controller and motor
- For use in assembling & pick-and-place machinery
- Particularly in wet areas of machine tools and transfer lines
- Assembly lines, production lines, in all kinds of machines

**Product features**

- Abrasion and cut-resistant, halogen-free, oil-resistant
- Flame-retardant according to IEC 60332-1-2 & CSA FT1
- Designed for 5 up to 10 million bending/unbending cycles in the power chain

**Norm references / Approvals**

- Power cable: VDE-registered UL AWM Style 21223 CSA AWM I/II, A/B 1000 V 80° FT 1
- Sensor leads: UL/CSA AWM Style 20236
- For horizontal travel distances up to 100m
- For use in power chains: Please comply with the assembly guidelines listed in Appendix T3
- UL File No. E63634

**Design**

- Extra-fine strand made of copper wires:
  - > Signal cables: tinned
  - > Power cables: bare
- Core insulation: polypropylene (PP)
- Tinned-copper braiding
- PUR outer sheath
- Signal cables: green (RAL 6018)
- Servo cable: orange (RAL 2003)

**Technical data**

- Conductor stranding**  
Extra-fine wire according to VDE 0295, class 6/IEC 60228 class 6
- Minimum bending radius**  
Power cable:  
Fixed: 4 x D  
Dynamic: 1.5 mm<sup>2</sup> - 16 mm<sup>2</sup>: 7.5 x D  
25 mm<sup>2</sup> - 50 mm<sup>2</sup>: 10 x D  
Signal cable:  
Fixed: 4 x D  
Dynamic: 8 x D
- Nominal voltage**  
Signal cables: 30 V AC/DC  
Power cable:  
- Power cores: 600/1000 V (IEC) 1000 V (UL/CSA)  
- Control cores: 24 V AC/DC (IEC) 1000 V (UL/CSA)
- Test voltage**  
Power cable: 4 KV  
Signal cables: 500 V
- Temperature range**  
Flexing: -20°C to +60°C  
Fixed installation: -50°C to +80°C

Article number	Number of cores and mm <sup>2</sup> per conductor	Reference article no.	Outer diameter (mm)	Copper index (kg/km)	Weight (kg/km)
<b>Feedback / signal cables</b>					
00277101	8 x 2 x 0,18	6FX8008-1BD11	7.8	54.0	85
00277111	4 x 2 x 0,38 + 4 x 0,5	6FX8008-1BD21	8.9	77.0	120
00277121	3 x (2 x 0,14) + 2 x (0,5)	6FX8008-1BD31	8.9	69.0	113
00277131	3 x (2 x 0,14) + 4 x 0,14 + 2 x 0,5	6FX8008-1BD41	8.8	66.0	101
00277141	3 x (2 x 0,14) + 4 x 0,14 + 2 x 0,5 + 4 x 0,22	6FX8008-1BD51	9.4	86.0	139
00277151	4 x 2 x 0,18	6FX8008-1BD61	6.4	34.2	53
00277161	2 x 2 x 0,18	6FX8008-1BD71	5.0	23.1	36
00277171	12 x 0,22	6FX8008-1BD81	6.9	48.0	76
00277992	2 x 2 x 0,15 + 1 x 2 x 0,38	6FX8008-2DC00	7.2	39.0	67
<b>Motor cables</b>					
0027784	4 G 1.5	6FX8008-1BB11-Plus	9.1	90.0	150
0027785	4 G 2.5	6FX8008-1BB21-Plus	10.6	132.0	220
0027786	4 G 4	6FX8008-1BB31-Plus	11.9	204.0	300
0027787	4 G 6	6FX8008-1BB41-Plus	14.5	315.0	450
0027788	4 G 10	6FX8008-1BB51-Plus	17.5	488.0	660
0027789	4 G 16	6FX8008-1BB61-Plus	21.6	769.0	1010
<b>Servo cables</b>					
0027790	4 G 1,5 + (2 x 1,5)	6FX8008-1BA11-Plus	11.6	146.0	230
0027791	4 G 2,5 + (2 x 1,5)	6FX8008-1BA21-Plus	13.4	187.0	300
0027792	4 G 4 + (2 x 1,5)	6FX8008-1BA31-Plus	14.8	258.0	380
0027793	4 G 6 + (2 x 1,5)	6FX8008-1BA41-Plus	16.8	365.0	530
0027794	4 G 10 + (2 x 1,5)	6FX8008-1BA51-Plus	19.4	560.0	765
0027795	4 G 16 + (2 x 1,5)	6FX8008-1BA61-Plus	23.1	816.0	1090
0027796	4 G 25 + (2 x 1,5)	6FX8008-1BA25-Plus	26.6	1,166.0	1530
0027797	4 G 35 + (2 x 1,5)	6FX8008-1BA35-Plus	30.9	1,554.0	2040
0027798	4 G 50 + (2 x 1,5)	6FX8008-1BA50-Plus	34.0	2,188.0	2760

Unless specified otherwise, the shown product values are nominal values. Detailed values (e.g. tolerances) are available upon request.  
 Copper price basis: EUR 150/100kg. Refer to catalogue appendix T17 for the definition and calculation of copper-related surcharges.  
 Please find our standard lengths at: [www.lappkabel.de/en/cable-standardlengths](http://www.lappkabel.de/en/cable-standardlengths)  
 Packaging size: coil ≤ 30 kg or ≤ 250 m, otherwise drum  
 Please specify the preferred type of packaging (e.g. 1 x 500 m drum or 5 x 100 m coils).  
 Siemens part designations (6FX5002/5008, 6FX7002/7008, 6FX8002/8008) are registered trademarks of Siemens AG, and are listed for comparison purposes only  
 Cables for power chain use should only be handled on drums prior to installation.  
 Article numbers refer to genuine Lapp products.  
 Photographs are not to scale and do not represent detailed images of the respective products.

**Similar products**

- ÖLFLEX® SERVO FD 796 CP refer to page 13

**Accessories**

- Circular connectors refer to page 256
- SKINTOP® EMC/Earthing refer to page 263



## SERVO cables in acc. to INDRAMAT® Standard INK

Motor and resolver/encoder cables

**Info**

- Servo drives
- EMC-compliant



### Benefits

- Multi-standard = fewer part varieties = cost savings
- Also suitable for mobile outdoor use

### Application range

- Connecting cable between servo controller and encoder/resolver
- Connecting cable between servo controller and motor
- Particularly in wet areas of machine tools and transfer lines
- Assembly lines, production lines, in all kinds of machines

### Product features

- Abrasion and cut-resistant
- Oil-resistant
- Flame-retardant according to IEC 60332-1-2 & CSA FT 1
- Halogen-free
- Designed for 2 up to 8 million bending/un-bending cycles in power chain applications

### Norm references / Approvals

- Power cable: UL style 20234
- Signal cables: UL Style 20236
- For horizontal travel distances up to 100m
- For use in power chains: Please comply with the assembly guidelines listed in Appendix T3
- UL File No. E63634

### Design

- In accordance with INDRAMAT® standard INK (also suitable for pre-assembled versions, IKS and IKG)
- Core insulation: TPE
- Refer to data sheet (available upon request) for more details
- Tinned-copper braiding
- PUR outer sheath, orange (RAL 2003)

### Technical data

**Conductor stranding**  
Extra-fine wire according to IEC 60228 class 6

**Minimum bending radius**  
Power cable:  
Fixed installation: 4 x outer diameter  
For flexible use: 7.5 x outer diameter  
Signal cables:  
Fixed installation: 5 x outer diameter  
For flexible use: 10 x D

**Nominal voltage**  
Power cable:  
- Power cores: 600/1000 V (IEC) 1000 V (UL/CSA)  
- Control cores: 250 V AC (IEC) 1000 V (UL/CSA)  
Signalling cables: 300 V (IEC), 300 V (UL/CSA)

**Test voltage**  
Power cable:  
Power cores: 4000 V eff.  
Control cores: 2000 V eff.  
Signal cables: 500 V rms

**Temperature range**  
Fixed installation: -50°C to +80°C  
Flexing: -30°C to +80°C

Article number	Number of cores and mm <sup>2</sup> per conductor	Reference article no.	Outer diameter (mm)	Copper index (kg/km)	Weight (kg/km)
<b>Feedback / encoder / resolver cables</b>					
7072400	4 x 2 x 0,25 + 2 x 1,0	INK-0209	8.8	74.0	120
7072401	4 x 2 x 0,25 + 2 x 0,5	INK-0448	8.5	70.0	100
7072402	9 x 0,5	INK-0208	8.8	75.0	126
7072414	4 x 1,0 + 4 x 2 x 0,14 + 4 x 0,14	INK-0532	9.7	81.0	140
7072415	2 x (2 x 0,25) + 2 x 0,5	INK-0234	8.7	46.0	90
7072416	2 x 2 x 0,25 + 2 x 0,5	INK-0750	7.6	35.0	92
<b>Servo cables</b>					
7072417	4 G 0,75 + 2 x 0,5	INK-0670	10.0	73.0	132
7072403	4 G 1,0 + 2 x (2 x 0,75)	INK-0653	11.5	170.0	226
7072404	4 G 1,5 + 2 x (2 x 0,75)	INK-0650	12.2	189.0	268
7072405	4 G 2,5 + 2 x (2 x 1,0)	INK-0602	15.1	212.0	320
7072406	4 G 4 + (2 x 1,0) + (2 x 1,5)	INK-0603	16.0	306.0	470
7072407	4 G 6 + (2 x 1,0) + (2 x 1,5)	INK-0604	18.8	366.0	600
7072408	4 G 10 + (2 x 1,0) + (2 x 1,5)	INK-0605	22.0	565.0	850
7072409	4 G 16 + 2 x (2 x 1,5)	INK-0606	25.2	838.0	1020
7072410	4 G 25 + 2 x (2 x 1,5)	INK-0607	28.0	1,231.0	1420

Unless specified otherwise, the shown product values are nominal values. Detailed values (e.g. tolerances) are available upon request.

Copper price basis: EUR 150/100kg. Refer to catalogue appendix T17 for the definition and calculation of copper-related surcharges.

Please find our standard lengths at: [www.lappkabel.de/en/cable-standardlengths](http://www.lappkabel.de/en/cable-standardlengths)

Packaging size: coil ≤ 30 kg or ≤ 250 m, otherwise drum

Please specify the preferred type of packaging (e.g. 1 x 500 m drum or 5 x 100 m coils).

Indramat part designations (IKG, IKS, INK, INS, RKL and RKG) are registered trademarks of Bosch Rexroth AG, and are listed for comparison purposes only.

Cables for power chain use should only be handled on drums prior to installation.

Article numbers refer to genuine Lapp products.

Photographs are not to scale and do not represent detailed images of the respective products.

### Similar products

- ÖLFLEX® SERVO FD 796 CP refer to page 13

### Accessories

- Circular connectors refer to page 256
- SKINTOP® EMC/Earthing refer to page 263

**Power chain applications**

Servo applications - power drive systems, approved



**SERVO cables in acc. to LENZE® Standard**

Motor and resolver/encoder cables



**Info**

- Servo drives
- EMC-compliant

**Benefits**

- Motor cables with low-capacitance
- Multi-standard = fewer part varieties = cost savings

**Application range**

- Connecting cable between servo controller and encoder/resolver
- Connecting cable between servo controller and motor
- Plant engineering
- Particularly in wet areas of machine tools and transfer lines
- Assembly lines, production lines, in all kinds of machines

**Norm references / Approvals**

- Resolver and encoder cable: UL AWM Style 2464 for fixed installation versions, Style 21165 for highly flexible applications.
- Motor cable: UL AWM Style 2570 for fixed installation version; Style 20940 for high flexibility use.
- Designed for power chain use: for travel distances up to 100 m (horizontal)
- For use in power chains: Please comply with the assembly guidelines listed in Appendix T3
- UL File No. E63634

**Design**

- Design according to LENZE® standard:
- Designs for fixed installation: PVC outer sheath, flame-retardant in accordance with IEC 332.1, UL/CSA-approved PP core insulation.
- Designs for highly flexible use: oil-resistant PUR sheath in accordance with VDE472-803 Part B, flame-retardant in accordance with IEC 60332.1-2, TPE core insulation.
- Refer to data sheet (available upon request) for more details
- Signal cables: green (RAL 6018)
- Servo cable: orange (RAL 2003)

**Technical data**

**Core identification code**  
Encoder cables  
- 7072508 (fixed installation) bk/ye+bk/gn+bk/rd+bk/bl + bk/wt  
- 7072517 (flexible installation) gn/ye+bl/rd+gy/pk+bk/vi + bn/wt  
Resolver cables:  
- 7072507 (fixed installation) black/yellow + black/green + black/red + black/white  
- 7072516 (flexible application) green/yellow + blue/red + grey/pink + brown/white

**Minimum bending radius**  
Flexible use: 10 x outer diameter  
Fixed installation: 7.5 x cable diameter

**Nominal voltage**  
Resolver and encoder cable: 30 V (VDE), 300 V (UL/CSA)  
Motor cable: Power cores:  $U_0/U$  0.6/1 kV (VDE), 600 V (UL/CSA)

**Test voltage**  
Resolver and encoder cable: 1.5 kV  
Motor cable: - Power cores: 4 kV  
- Control cores: 2 kV

**Temperature range**  
Flexing: -5°C to +70°C  
Fixed installation: -40°C to +80°C

Article number	Number of cores and mm <sup>2</sup> per conductor	Outer diameter (mm)	Copper index (kg/km)	Weight (kg/km)
<b>Motor cables for fixed installation</b>				
7072500	4 G 1,0 + (2 x 0,5)	10.0	81.0	128
7072501	4 G 1,5 + (2 x 0,5)	11.2	106.0	173
7072502	4 G 2,5 + (2 x 0,5)	12.3	153.0	244
<b>Resolver/encoder cable, screened</b>				
7072507	3 x (2 x 0,14) + 1 x (2 x 0,5)	9.3	43.0	91
7072508	4 x (2 x 0,14) + 1 x (2 x 1,0)	11.0	65.0	136
<b>Motor cables for power chain application</b>				
7072509	4 G 1,0 + (2 x 0,5)	10.0	81.0	151

Article number	Number of cores and mm <sup>2</sup> per conductor	Outer diameter (mm)	Copper index (kg/km)	Weight (kg/km)
7072510	4 G 1,5 + (2 x 0,5)	11.5	106.0	192
7072511	4 G 2,5 + (2 x 0,5)	13.2	153.0	271
7072512	4 G 4 + (2 x 1,0)	14.6	235.0	373
7072513	4 G 6 + (2 x 1,0)	16.8	316.0	477
7072514	4 G 10 + (2 x 1,0)	20.1	513.0	710
7072515	4 G 16 + (2 x 1,0)	23.8	710.0	1015
<b>Resolver &amp; encoder cable for power chain applications</b>				
7072516	3 x (2 x 0,14) + 1 x (2 x 0,5)	10.0	44.0	107
7072517	4 x (2 x 0,14) + 1 x (2 x 1,0)	11.5	65.0	145

Unless specified otherwise, the shown product values are nominal values. Detailed values (e.g. tolerances) are available upon request.  
Copper price basis: EUR 150/100kg. Refer to catalogue appendix T17 for the definition and calculation of copper-related surcharges.  
Please find our standard lengths at: [www.lappkabel.de/en/cable-standardlengths](http://www.lappkabel.de/en/cable-standardlengths)  
Packaging size: coil ≤ 30 kg or ≤ 250 m, otherwise drum  
Please specify the preferred type of packaging (e.g. 1 x 500 m drum or 5 x 100 m coils).  
Lenze® part designations (EWLM\_, EWL\_R\_, EWLE\_, EWLL\_, EYL and EYP) are registered trademarks of Lenze® AG, and are listed for comparison purposes only. DESINA® is a registered trademark of the German Machine Tool Builders' Association.  
Cables for power chain use should only be handled on drums prior to installation.  
Article numbers refer to genuine Lapp products.  
Photographs are not to scale and do not represent detailed images of the respective products.

**Accessories**

- Circular connectors refer to page 256
- SKINTOP® EMC/Earthing refer to page 263





**UNITRONIC®**  
Data communication systems



## Bus systems

### Application areas for bus cables

- Plant engineering and construction
- Factory Automation (field busses like PROFIBUS, INTERBUS, DeviceNet, CAN etc.)
- Process Automation (chemical, petro-chemical industry etc.)
- Building Automation (building management)

### Overview of the most common bus systems

#### AS-Interface (AS-I)

Developed to have an inexpensive alternative on the lower Fieldbus level (sensor/actuator) of Automation. Used very often in connection with Ethernet, PROFIBUS, CAN and DeviceNet.

#### PROFIBUS

We distinguish between PROFIBUS DP and PROFIBUS PA. The DP variant dominates worldwide with a bit rate of 1.5 Mbit/s up to 12 Mbit/s PROFIBUS PA is the leader in Process Automation in Europe.

#### CAN/CANopen

Originally developed for cars. Used in industry in an extremely broad range of applications.

#### DeviceNet™

Prior Fieldbussystem in North America. Developed by Allen Bradley (Rockwell Automation). Based on CAN.

#### Fieldbus Foundation™

Bus system for use in Process Automation.

#### SafetyBUS

Bus systems are developed especially for safety-relevant areas. They operate either completely independently (e.g: SaftyBUS p®) or are part of an overall system (e.g. PROFIsafe, INTERBUS Safty, DeviceNet Safty etc.).

#### INTERBUS®

One of the first field bus systems used in the automotive industry.

#### European Installation Bus EIB/KNX

Bus system for Building Automation. Operates primarily with low bit rate.

#### Other bus systems

For dedicated bus systems or modified system solutions based on standardized systems.

### Bus systems

Application areas for bus cables .....	22
Overview of the most common bus systems .....	22

### Fieldbussystem

Quickfinder bus cables .....	23
Quickfinder connectors .....	25
PROFIBUS quick and easy .....	26
Quickfinder fieldbus cables (continuation) .....	27
The complete range .....	29
Fieldbus sensor/actuator cabling .....	30
Type designation UNITRONIC® Fieldbus .....	31
Worldwide connections. We deliver them with systems.....	33
1a. Sensor/actuator cordsets .....	35
1b. Selector: M8/M12 connectors (field attachable) – sensor cable .....	39
1c. Valve connectors .....	41
1d. Selector: Flush-type connectors .....	43
2. Selector: Structured Fieldbus wiring for passive S/A distribution box to PLC I/O .....	43
3. Selector: Bus-compatible S/A boxes active (IP65/67) .....	45
4. Selector: Bus-compatible S/A boxes active (IP30/IP67).....	47

Product Pages .....	49
---------------------	----

For current information see [www.lappgroup.com/products](http://www.lappgroup.com/products)

CAN = Controller Area Network  
 DeviceNet™ = registered trademark of Open Device Vendors Association (ODVA)  
 Fieldbus Foundation™ = registered trademark of Fieldbus Foundation™  
 SafetyBUS p® = registered trademark of Pilz GmbH & Co. KG  
 INTERBUS® = registered trademark of Phoenix Contact GmbH & Co  
 Lapp Kabel is a member of the PROFIBUS user organisation e. V. (PNO)



## Quickfinder bus cables

Bus system	Inst. area	Application/cabling	Outer sheath material	Approval	Characteristics	Article designation	Article number	Page	Connectors
PROFIBUS DP (150 Ω)	indoor (UV = outdoor)	static	PVC	UL/CSA (CMX)		UNITRONIC® BUS PB	2170220	51	1,2,7,8,13,14,19,20,21,22,25,26,27
				UL/CSA (CMG)	Fast Connect, UV-resistant	UNITRONIC® BUS PB A	2170219	51	1,2,7,8,13,14,19,20,21,22,25,26,27
					105 °C	UNITRONIC® BUS PB FC	2170820	51	3,4,9,11,15,16,23
				UL/CSA (PLTC-ER)	PLTC-ER approval for cable trays	UNITRONIC® BUS PB 105	2170630	54	1,2,7,8,13,14,19,20,21,22,25,26,27
						UNITRONIC® BUS PB TRAY	2170856	52	1,2,7,8,13,14,19,20,21,22,25,26,27
			H	UL/CSA (CM)	Fast Connect, halogen-free	UNITRONIC® BUS PB H FC	2170326	51	3,4,9,11,15,16,23
				UL/CSA (CMG)	Fast Connect, halogen-free	UNITRONIC® BUS PB FRNC FC	2170853	56	3,4,9,11,15,16,23,26,27
			PUR	UL/CSA (CMX)	Fast Connect, oil resistant	UNITRONIC® BUS PB P FC	2170330	51	3,4,9,11,15,16,23
			ROBUST		higher chemical resistance, UV-resistant	UNITRONIC® BUS PB ROBUST	2170620	53	1,2,7,8,13,14,19,20,21,22
		PE		Fast Connect, food & beverage industry, black, UV-resistant	UNITRONIC® BUS PB PE FC	2170333	51	3,4,9,11,15,16,23	
				food & beverage industry, black, UV-resistant	UNITRONIC® BUS PB PE	2170233	51	1,2,7,8,13,14,19,20,21,22,25,26,27	
		TPE		105 °C; temporary up to 120 °C	UNITRONIC® BUS PB 105 plus	2170635	54	1,2,7,8,13,14,19,20,21,22,25,26,27	
		FEP		180 °C heat resistant, -50 °C cold resistant	UNITRONIC® BUS PB HEAT 180	3031981	55	1,2,7,8,13,14,19,20,21,22,25,26,27	
		static/flexible	PVC	UL/CSA (CMG)	vibration resistant, UV-resistant	UNITRONIC® BUS PB 7-W A	2170824	51	1,2,7,8,13,14,19,20,21,22,28,29
					Fast Connect, vibration resistant, UV-resistant, black	UNITRONIC® BUS PB Y 7-W FC BK	2170310	60	5,6,10,12,17,18,24,28,29
				UL/CSA (CMG)	Fast Connect, vibration resistant, UV-resistant	UNITRONIC® BUS PB 7-W FC	2170826	51	5,6,10,12,17,18,24,28,29
			H		vibration resistant, COMBI 3 x 1 mm <sup>2</sup>	UNITRONIC® BUS PB COMBI 7-W	2170225	51	
					halogen-free	UNITRONIC® BUS PB H 7-W	2170226	51	1,2,7,8,13,14,19,20,21,22,28,29
					UNITRONIC® BUS PB H 7-W	2170222	61	1,2,7,8,13,14,19,20,21,22,28,29	
	high flexible	PUR		drag chain suitable, halogen-free, oil resistant	UNITRONIC® BUS PB FD P	2170222	61	1,2,7,8,13,14,19,20,21,22,28,29	
			UL/CSA (CMX)	drag chain suitable, halogen-free, oil resistant	UNITRONIC® BUS PB FD P A	2170822	62	1,2,7,8,13,14,19,20,21,22,28,29	
			UL/CSA (CMX)	Fast Connect, drag chain suitable, oil resistant	UNITRONIC® BUS PB FD P FC	2170322	63	5,6,12,12,17,18,24,28,29	
				drag chain suitable, oil resistant, COMBI 3 x 1 mm <sup>2</sup>	UNITRONIC® BUS PB FD P COMBI	2170227	65		
			drag chain suitable, oil resistant, COMBI 4 x 1.5 mm <sup>2</sup>	UNITRONIC® BUS PB FD P HYBRID	2170495	65			
		PVC	UL/CSA (CMG)	drag chain suitable, oil resistant, UV-resistant, COMBI 4 x 1.5 mm <sup>2</sup>	UNITRONIC® BUS PB FD Y HYBRID	2170875	66		
		FRNC	UL/CSA (CMG)	Fast Connect, drag chain suitable, halogen-free, flame retardant	UNITRONIC® BUS PB FD FRNC FC	2170854	64	5,6,10,12,17,18,24,28,29	
	torsion	PUR	UL/CSA (CMX)	torsion, halogen-free	UNITRONIC® BUS PB TORSION	2170332	67	1,2,7,8,13,14,19,20,21,22,28,29	
	festoon	PVC	UL/CSA (CMG)	cable trolley, festoon, UV-resistant	UNITRONIC® BUS PB FESTOON	2170331	68	1,2,7,8,13,14,19,20,21,22,28,29	
outdoor & burial	static	PVC		UV-resistant, armoured, max. EMV-protection	UNITRONIC® BUS PB ARM	2170247	55		
				UV-resistant, burial, black	UNITRONIC® BUS PB Yv	2170223	57		
				UV-resistant, burial, black	UNITRONIC® BUS PB YY	2170236	58	1,2,7,8,13,14,19,20,21,22,25,26,27***	
		PVC/PE		Fast Connect, UV-resistant, burial, black	UNITRONIC® BUS PB BURIAL FC	2170323	59	3,4,9,11,15,16,23****	
PROFIBUS PA (100 Ω)	indoor	static	PVC		Ex area, blue	UNITRONIC® BUS PA BU	2170234	*	28,29
	indoor/outdoor	static	PVC	UL/CSA (CMG)	UV-resistant, black	UNITRONIC® BUS PA BK	2170235	*	
					Fast Connect, Ex area, oil resistant, UV-resistant, blue	UNITRONIC® BUS PA FC (BU)	2170334	*	
					Fast Connect, oil resistant, UV-resistant, black	UNITRONIC® BUS PA FC (BK)	2170335	*	
CAN CANopen (120 Ω)	indoor	static	PVC	UL/CSA (CMX)	vibration resistant	UNITRONIC® BUS CAN 1X2X0,22	2170260	78	33,34,30,31
						UNITRONIC® BUS CAN 2X2X0,22	2170261	78	33,34,30,31
						UNITRONIC® BUS CAN 1X2X0,34	2170263	78	33,34,30,31
						UNITRONIC® BUS CAN 2X2X0,34	2170264	78	
						UNITRONIC® BUS CAN 1X2X0,5	2170266	78	33,34,30,31
						UNITRONIC® BUS CAN 2X2X0,5	2170267	78	
						UNITRONIC® BUS CAN 1X2X0,75	2170269	78	
		UNITRONIC® BUS CAN 2X2X0,75	2170270	78					
		static/flexible	PVC	UL/CSA (PLTC-ER)	PLTC-ER approval for cable tray	UNITRONIC® BUS CAN TRAY 2x2x0,34	2170857	79	
		high flexible	PUR	UL/CSA (CMX)	drag chain suitable, oil resistant, halogen-free	UNITRONIC® BUS CAN FD P 1X2X0,25	2170272	78	33,34,30,31
						UNITRONIC® BUS CAN FD P 2X2X0,25	2170273	78	
						UNITRONIC® BUS CAN FD P 1X2X0,34	2170275	78	33,34,30,31
						UNITRONIC® BUS CAN FD P 2X2X0,34	2170276	78	
						UNITRONIC® BUS CAN FD P 1X2X0,5	2170278	78	33,34,30,31
	UNITRONIC® BUS CAN FD P 2X2X0,5					2170279	78		
outdoor & burial	static	PVC/PE		UV-resistant, burial, black	UNITRONIC® BUS CAN BURIAL 2X2X0,5	2170500	*		
DeviceNet (120 Ω)	indoor (UV = outdoor)	static	FRNC	UL/CSA (CMG) Germ. Lloyd	vibration resistant, halogen-free, UV-resistant	UNITRONIC® BUS DN THICK FRNC	2170340	76	
						UNITRONIC® BUS DN THIN FRNC	2170341	76	33,34,30,31
			PVC	UL/CSA (CMG)	vibration resistant, oil resistant, UV-resistant	UNITRONIC® BUS DN THICK Y	2170342	76	
						UNITRONIC® BUS DN THIN Y	2170343	76	33,34,30,31
						UNITRONIC® BUS DN THICK Y ECO	2170362	*	
	UL/CSA (CMG)	vibration resistant, UV-resistant	UNITRONIC® BUS DN THIN Y ECO	2170363	*	33,34,30,31			

See continuation page 27

### Legend

\*see [www.lappgroup.com/products](http://www.lappgroup.com/products)  
 \*\*data sheet on [www.lappgroup.com/products](http://www.lappgroup.com/products)  
 \*\*\*second outer sheath PVC need to be removed before harnessing  
 \*\*\*\*second outer sheath PE need to be removed before harnessing  
 Please see detailed technical information on the data sheet ([www.lappgroup.com/products](http://www.lappgroup.com/products)).

7-W: 7-Wire: 7-stranded litz, dedicated for vibrating machine parts  
 CAN: Controller Area Network  
 FC: Fast Connect (cable construction for fast connector harnessing)  
 FD: high flexible (german - "Flexible Dauerbiegung")  
 FRNC: Flame Retardant Not Corrosive

H: halogen-free  
 LD: Long Distance  
 P: PUR - Polyurethan - oil resistant  
 PA: Process Automation  
 PB: PROFIBUS

PE: Polyethlen: can be used in food & beverage industry  
 PROFIBUS PA: PROFIBUS for Process Automation, especially in hazardous areas  
 ROBUST: extended use: Water, chemical resistance, soap, tensile  
 vibration resistant: Vibration resistant because single core ist 7-wire stranded  
 Y: PVC - Polyvinylchlorid

# Fieldbus systems

Quickfinder connectors					
No.	Cable type	Core dimension	Article designation	Article number	Page
<b>PROFIBUS D-SUB</b>					
1	solid + flexible	≤ 1 mm <sup>2</sup>	ED-PB-35	21700507	69
2	solid + flexible	≤ 1 mm <sup>2</sup>	ED-PB-35-PG	21700506	69
3	solid	0.64 mm	ED-PB-35-FC	21700511	70
4	solid	0.64 mm	ED-PB-35-PG-FC	21700513	70
5	flexible	0.64 mm	ED-PB-35-FC-FLEX	21700514	70
6	flexible	0.64 mm	ED-PB-35-PG-FC-FLEX	21700515	70
7	solid + flexible	≤ 1 mm <sup>2</sup>	ED-PB-90	21700504	69
8	solid + flexible	≤ 1 mm <sup>2</sup>	ED-PB-90-PG	21700503	69
9	solid	0.64 mm	ED-PB-90-FC	21700502	70
10	flexible	0.64 mm	ED-PB-90-FC-FLEX	21700528	70
11	solid	0.64 mm	ED-PB-90-PG-FC	21700501	70
12	flexible	0.64 mm	ED-PB-90-PG-FC-FLEX	21700527	70
13	solid + flexible	≤ 1 mm <sup>2</sup>	ED-PB-90-LED	21700530	69
14	solid + flexible	≤ 1 mm <sup>2</sup>	ED-PB-90-PG-LED	21700529	69
15	solid	0.64 mm	ED-PB-90-LED-FC	21700547	70
16	solid	0.64 mm	ED-PB-90-PG-LED-FC	21700546	70
17	flexible	0.64 mm	ED-PB-90-LED-FC-FLEX	21700549	70
18	flexible	0.64 mm	ED-PB-90-PG-LED-FC-FLEX	21700539	70
19	solid + flexible	≤ 1 mm <sup>2</sup>	ED-PB-90-ATEX	21700543	71
20	solid + flexible	≤ 1 mm <sup>2</sup>	ED-PB-90-PG-ATEX	21700542	71
21	solid + flexible	≤ 1 mm <sup>2</sup>	ED-PB-90-RP-PG	21700541	72
22	solid + flexible	≤ 1 mm <sup>2</sup>	ED-PB-AX	21700505	69
23	solid	0.64 mm	ED-PB-AX-FC	21700544	70
24	flexible	0.64 mm	ED-PB-AX-FC-FLEX	21700545	70
<b>PROFIBUS D-SUB solid metal</b>					
25	solid	≤ 0.5 mm <sup>2</sup>	ED-PB-35-PG-ST-PRO	21700564	74
26	solid	≤ 0.5 mm <sup>2</sup>	ED-PB-90-PG-ST-PRO	21700565	74
27	solid	≤ 0.5 mm <sup>2</sup>	ED-PB-AX-PG-ST-PRO	21700566	74
<b>PROFIBUS M12</b>					
28	flexible	0.25 - 0.75 mm <sup>2</sup>	AB-C5-M12MSB-PG9-SH-AU	22260653	133
29	flexible	0.25 - 0.75 mm <sup>2</sup>	AB-C5-M12FSB-PG9-SH-AU	22260646	133
<b>CAN BUS /DeviceNet M12</b>					
30	flexible	0.25 - 0.75 mm <sup>2</sup>	AB-C5-M12MS-PG9-SH	22260135	133
31	flexible	0.25 - 0.75 mm <sup>2</sup>	AB-C5-M12FS-PG9-SH	22260136	133
<b>CAN/CANopen/DeviceNet</b>					
32	solid + flexible	≤ 1 mm <sup>2</sup>	ED-CAN-90	21700537	80
33	solid + flexible	≤ 1 mm <sup>2</sup>	ED-CAN-90-PG	21700536	80
34	solid + flexible	≤ 1 mm <sup>2</sup>	ED-CAN-AX	21700538	80
<b>AS-Interface distributor</b>					
No.	Cable type	Distributor	Article designation	Article number	Page
41	flexible	1 x AS-I → 2-pin M12	AB-ASI-J-Y-N-M12FS	22260800	124
42	flexible	2 x AS-I → 4-pin M12	AB-ASI-J-Y-B-M12FS	22260801	124
43	flexible	1 x AS-I → 2 x AS-I	AB-ASI-J-Y-Y-N	22260802	124
44	flexible	1 x AS-I → 2-pin M12 1m	AB-ASI-J-Y-N-PUR-1,0-M12FS	22260803	124
45	flexible	1 x AS-I → 2-pin M12 2m	AB-ASI-J-Y-N-PUR-2,0-M12FS	22260804	124
46	flexible	2 x AS-I → 4-pin M12 1m	AB-ASI-J-Y-B-PUR-1,0-M12FS	22260805	124
47	flexible	2 x AS-I → 4-pin M12 2m	AB-ASI-J-Y-B-PUR-2,0-M12FS	22260806	124

### Legend

35°	35 degree	FSB	Female Straight Bus
90°	90 degree	MSB	Male Straight Bus
ATEX	ATEX (atmosphère explosible)	PB	PROFIBUS
AX	axial (180°)	PG	service port
CAN	CAN bus	PG9	PG9 cable screw connection
ED	EPIC® Data	RP	Repeater
FC	Fast Connect	ST	spring type
FLEX	flexible		

Please see detailed technical information on the data sheet ([www.lappgroup.com/products](http://www.lappgroup.com/products)).

# Fieldbus systems

PROFIBUS quick and easy						
No.	Cable type	Article designation	Article number	Page		
<b>PROFIBUS D-SUB /M12</b>						
1	EPIC® Data, metallized plastic	ED-PB-90-M12	21700521	73		
2	EPIC® Data, metallized plastic	ED-PB-90-PG-M12	21700520	73		
3	EPIC® Data PRO, solid metall	ED-PB-35-PG-M12-PRO	21700561	74		
4	EPIC® Data PRO, solid metall	ED-PB-90-PG-M12-PRO	21700562	74		
5	EPIC® Data PRO, solid metall	ED-PB-AX-PG-M12-PRO	21700563	74		
<b>M12 PROFIBUS Termination Resistors</b>						
6	360° metall shielded, female straight	AB-C5-M12FS-PB-TR-SH	22261001	134		
7	Plastic, male straight	AB-C4-M12MS-PB-TR	22260722	134		
<b>PROFIBUS CORDS M12-male connector/M12-female connector</b>						
8	UNITRONIC® PROFIBUS M12 cable, PUR high flexible, straight 0.3 m	AB-PB-M12MS-0,3PUR-M12FS	22260773	130		
9	UNITRONIC® PROFIBUS M12 cable, PUR high flexible, straight 1 m	AB-PB-M12MS-1,0-PUR-M12FS	22260774	130		
10	UNITRONIC® PROFIBUS M12 cable, PUR high flexible, straight 2 m	AB-PB-M12MS-2,0-PUR-M12FS	22260775	130		
11	UNITRONIC® PROFIBUS M12 cable, PUR high flexible, straight 5 m	AB-PB-M12MS-5,0-PUR-M12FS	22260776	130		
12	UNITRONIC® PROFIBUS M12 cable, PUR high flexible, straight 10 m	AB-PB-M12MS-10,0-PUR-M12FS	22260777	130		
13	UNITRONIC® PROFIBUS M12 cable, PUR high flexible, straight 15 m	AB-PB-M12MS-15,0-PUR-M12FS	22260907	130		
14	UNITRONIC® PROFIBUS M12 cable, PUR high flexible, straight 20 m	AB-PB-M12MS-20,0-PUR-M12FS	22260908	130		
15	UNITRONIC® PROFIBUS M12 cable, PUR high flexible, M12 angled 5 m	AB-PB-M12MA-5,0PUR-M12FA	22260079	130		
16	UNITRONIC® PROFIBUS M12 cable, PUR high flexible, M12 angled 10 m	AB-PB-M12MA-10,0PUR-M12FA	22260904	130		
17	UNITRONIC® PROFIBUS M12 cable, PUR hochflexibel, M12 angled 15 m	AB-PB-M12MA-15,0PUR-M12FA	22260905	130		
<b>EPIC® Data PROFIBUS (Optical Link Module)</b>						
18	PROFIBUS-connector with optical HFBR interface (λ = 650 nm), 90°	ED-PB-90-PG-FO-HFBR-650	21700568	75		
19	PROFIBUS-connector with optical SMA interface (λ = 650 nm), 90°	ED-PB-90-PG-FO-SMA-650	21700569	75		
20	PROFIBUS-connector with optical (BFOC)ST interface (λ = 650 nm), 90°	ED-PB-90-PG-FO-BFOC-650	21700570	75		

### Legend

35°	35 degree	FC	Fast connect	MS	Male straight
90°	90 degree	FLEX	Flexible	PB	PROFIBUS
AB	Automation Bus	FO	Fiber Optic	PG	Programing/service port
ATEX	ATEX (Atmosphère explosible)	FS	Female straight	RP	Repeater
AX	Axial (180°)	HFBR	HFBR interface (compatible with HP Versatile Link connectors and components series)	SMA	SMA interface
BFOC	BFOC (ST) interface			ST	Spring type
ED	EPIC® Data				
FA	Female angled	MA	Male angled		

Please see detailed technical information on the data sheet ([www.lappgroup.com/products](http://www.lappgroup.com/products)).

## Quickfinder fieldbus cables (continuation)

Bus system	Inst. area	Application/cabling	Outer sheath material	Approval	Characteristics	Article designation	Article number	Page	Connectors
DeviceNet (120 Ω)	indoor (UV = outdoor)	high flexible	PUR	UL/CSA (CMX)	drag chain suitable, halogen-free, UV-resistant	UNITRONIC® BUS DN THICK FD P	2170344	77	33,34,30,31
			PVC	UL/CSA (CMG)	drag chain suitable, oil resistant, UV-resistant	UNITRONIC® BUS DN THIN FD P	2170345	77	
					UNITRONIC® BUS DN THICK FD Y	2170346	77		
					UNITRONIC® BUS DN THIN FD Y	2170347	77		
AS-Interface (AS-I) (70 – 140 Ω)	indoor	static/flexible	EPDM (Rubber)		food & beverage industry, halogen-free	UNITRONIC® BUS ASI (G) YE	2170228	49	41-47
					Long Distance, saving of power supplies	UNITRONIC® BUS ASI (G) BK	2170229	49	
						UNITRONIC® BUS ASI LD(G) YE 2x2,5	2170371	49	
			TPE			UNITRONIC® BUS ASI LD(G) BK 2x2,5	2170372	49	
					oil resistant, cold flexible	UNITRONIC® BUS ASI (TPE) YE	2170230	49	
						UNITRONIC® BUS ASI (TPE) BK	2170231	49	
		PVC	UL/CSA (CMG)	oil resistant	UNITRONIC® BUS ASI (TPE) RD	2170232	49		
					UNITRONIC® BUS ASI (PVC) A YE	2170842	49		
				oil resistant	UNITRONIC® BUS ASI (PVC) A BK	2170843	49		
		high flexible	PUR	UL (AWM)	drag chain, oil resistant, Long Distance, halogen-free	UNITRONIC® BUS ASI (PVC) A RD	2170844	49	
						UNITRONIC® BUS ASI FD P FRNC YE	2170357	50	
						UNITRONIC® BUS ASI FD P FRNC BK	2170358	50	
TPE	UL (AWM) CSA		drag chain, oil resistant, cold flexible, Long Distance, halogen-free	UNITRONIC® BUS ASI LD FD P YE 2x2,5	2170318	50			
				UNITRONIC® BUS ASI LD FD P BK 2x2,5	2170319	*			
			drag chain suitable, oil resistant, 105 °C	UNITRONIC® BUS ASI FD (TPE) A YE	2170830	50			
			UNITRONIC® BUS ASI FD (TPE) A BK	2170831	50				
RS485, RS422 Bus systems (100 – 120 Ω)	indoor	static	PVC			UNITRONIC® BUS LD 1x2x0,22	2170203	*	Standard D-SUB connector 9-pos.
						UNITRONIC® BUS LD 2x2x0,22	2170204	*	
						UNITRONIC® BUS LD 3x2x0,22	2170205	*	
					UL/CSA (CMX)	UNITRONIC® BUS LD A 1x2x0,22	2170803	*	
						UNITRONIC® BUS LD FD P 1x2x0,25	2170213	*	
		high flexible	PUR	UL/CSA (CMX)	drag chain suitable, oil resistant	UNITRONIC® BUS LD FD P 2x2x0,25	2170214	*	
						UNITRONIC® BUS LD FD P 3x2x0,25	2170215	*	
						UNITRONIC® BUS LD FD P A 1x2x0,25	2170813	*	
						UNITRONIC® BUS LD FD P A 2x2x0,26	2170814	*	
						drag chain suitable, oil resistant	UNITRONIC® BUS LD FD P A 3x2x0,27	2170815	
Fieldbus Foundation™ (100 Ω)	indoor/outdoor	flexible	PVC	UL/CSA (CMG)	105 °C, UV-resistant, yellow	UNITRONIC® BUS FF 3	2170350	*	
					105 °C, UV-resistant, yellow	UNITRONIC® BUS FF 2	2170352	*	
		static	PVC	UL/CSA (CMG)	105 °C, UV-resistant, armoured, ++ EMV, yellow	UNITRONIC® BUS FF 3 ARM (YE)	2170351	*	
					105 °C, UV-resistant, armoured, ++ EMV, blue	UNITRONIC® BUS FF 3 ARM (BU)	2170353	*	
CC-Link® (110 Ω)	indoor/outdoor	flexible	PVC	UL (CM) CLPA	UV-resistant	UNITRONIC® BUS CC	2170360	*	
	indoor	high flexible	PUR	UL (AWM)	drag chain suitable, halogen-free, oil resistant,	UNITRONIC® BUS CC FD P FRNC	2170370	*	
SafetyBUS (120 Ω)	indoor	static	H		halogen-free, vibration resistant	UNITRONIC® BUS SAFETY	2170295	*	
		high flexible	PUR		drag chain suitable, halogen-free	UNITRONIC® BUS SAFETY FD P	2170885	*	
INTERBUS (100 Ω)	indoor	static	PVC		vibration resistant	UNITRONIC® BUS IBS	2170206	*	Standard D-SUB connector 9-pos.
				UL/CSA (CMX)	vibration resistant	UNITRONIC® BUS IBS A	2170209	*	
		PUR		vibration resistant, COMBI 3 x 1 mm <sup>2</sup>	UNITRONIC® BUS IBS P COMBI	2170208	*		
				drag chain suitable	UNITRONIC® BUS IBS FD P	2170216	*		
	high flexible	PUR	UL/CSA (CMX)	drag chain suitable, COMBI 3 x 1 mm <sup>2</sup>	UNITRONIC® BUS IBS FD P COMBI	2170218	*		
					UNITRONIC® BUS IBS FD P COMBI A	2170818	*		
					vibration resistant	UNITRONIC® BUS IBS Yv	2170207	*	
					vibration resistant	UNITRONIC® BUS IBS Yv COMBI	2170217	*	
European Installation Bus EIB/KNX	indoor	static	PVC			UNITRONIC® BUS EIB	2170240	*	
			H		halogen-free	UNITRONIC® BUS EIB H	2170241	*	
			PVC		COMBI 3 x 1.5 mm <sup>2</sup>	UNITRONIC® BUS EIB COMBI	2170242	*	

### Legend

7-W:	7-Wire: 7-stranded litz, dedicated for vibrating machine parts	PA:	Process Automation
CAN:	Controller Area Network	PB:	PROFIBUS
FC:	Fast Connect (cable construction for fast connector harnessing)	PE:	Polyethlen: can be used in food & beverage industry
FD:	high flexible (german – "Flexible Dauerbiegung")	PROFIBUS PA:	PROFIBUS for Process Automation, especially in hazardous areas
FRNC:	Flame Retardant Not Corrosive	ROBUST:	extended use: Water, chemical resistance, soap, tensile
H:	halogen-free	vibration resistant:	Vibration resistant because single core ist 7-wire stranded
LD:	Long Distance	Y:	PVC – Polyvinylchlorid
P:	PUR – Polyurethan – oil resistant		

\*see [www.lappgroup.com/products](http://www.lappgroup.com/products)

\*\*\*second outer sheath PVC need to be removed before harnessing

\*\*\*\*second outer sheath PE need to be removed before harnessing

Please see detailed technical information on the data sheet ([www.lappgroup.com/products](http://www.lappgroup.com/products)).

Adapter					
AS-Interface distributor					
No.	Cable type	Distributor	Article designation	Article number	Page
41	flexible	1 x AS-I → 2-pos. M12	AB-ASI-J-Y-N-M12FS	22260800	124
42	flexible	2 x AS-I → 4-pos. M12	AB-ASI-J-Y-B-M12FS	22260801	124
43	flexible	1 x AS-I → 2 x AS-I	AB-ASI-J-Y-Y-N	22260802	124
44	flexible	1 x AS-I → 2-pos. M12 1m	AB-ASI-J-Y-N-PUR-1,0-M12FS	22260803	124
45	flexible	1 x AS-I → 2-pos. M12 2m	AB-ASI-J-Y-N-PUR-2,0-M12FS	22260804	124
46	flexible	2 x AS-I → 4-pos. M12 1m	AB-ASI-J-Y-B-PUR-1,0-M12FS	22260805	124
47	flexible	2 x AS-I → 4-pos. M12 2m	AB-ASI-J-Y-B-PUR-2,0-M12FS	22260806	124





## The complete range

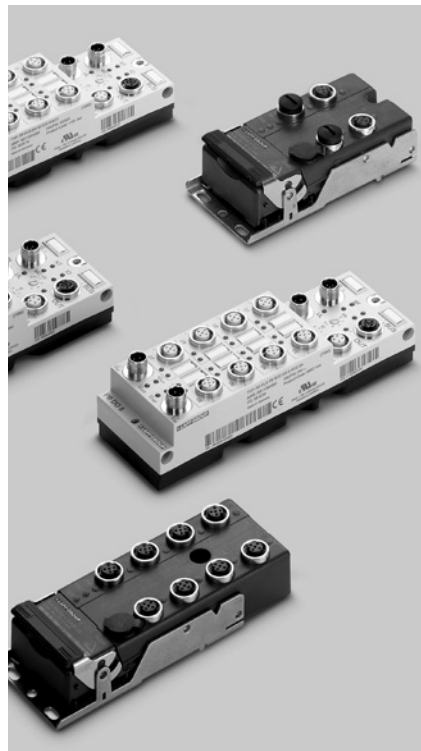

### Sensor/Actuator boxes

Sensor/actuator boxes with the standardized connection technology provide connections to all commercially available sensors and -actuators and are the solution for decentralizing small numbers of I/O's. Sensor/actuator boxes can be connected to the Profibus, DeviceNet™ and CANopen fieldbus systems. Regardless of -whether you are installing them

on profiles, on flat surfaces or under rough conditions - the assembly concept ensures flexibility and reduces the installation costs. The devices enable assembly in two directions and are thus suitable for every application. The arrangement of connectors minimizes the installation time even under rough conditions.

### Sensor/Actuator cables

A comprehensive range of pre-assembled conductors with M8-, M12- and valve-connectors for rapid wiring of sensors and actuators in the field are available. Sensor/actuator cables with LEDs

can be used for simplified control of signal status. Shielded wiring types are also available for those applications with higher EMV capability.

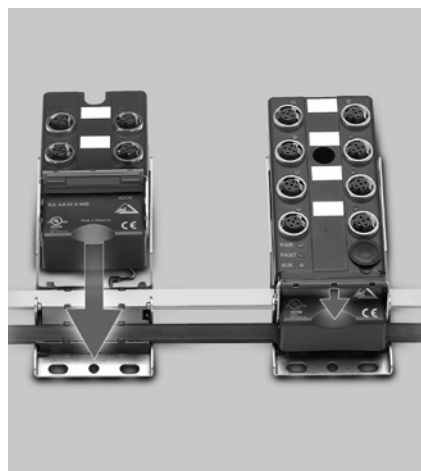

### AS-I boxes - Easy cabling in the lower field level

The AS-I devices were designed for efficiently networking sensors and actuators in the AS-I network and allow for fast and safe installation with tool-free contacting.

connection to the AS-I flat conductors. They are pressed into the corresponding guide aids and the module electronics are moved forward. The devices are connected to the AS-I flat conductors using the penetration technique by snapping the hinged section into place.

AS-I devices can be installed quickly and easily. The locking mechanism allows a tool-free



### Sensor/Actuator flush type connectors and customer assembled plug connectors

M8 and M12 flush type connectors with integrated braid for device connection to the PCB is available. Freely customizable plug connectors can be used for rapid assem-

bly of individual wiring lengths of M8 and M12 sensor/actuator cables. Here it is possible to choose between versions with screw or fast connectors.

## Fieldbus sensor/actuator cabling

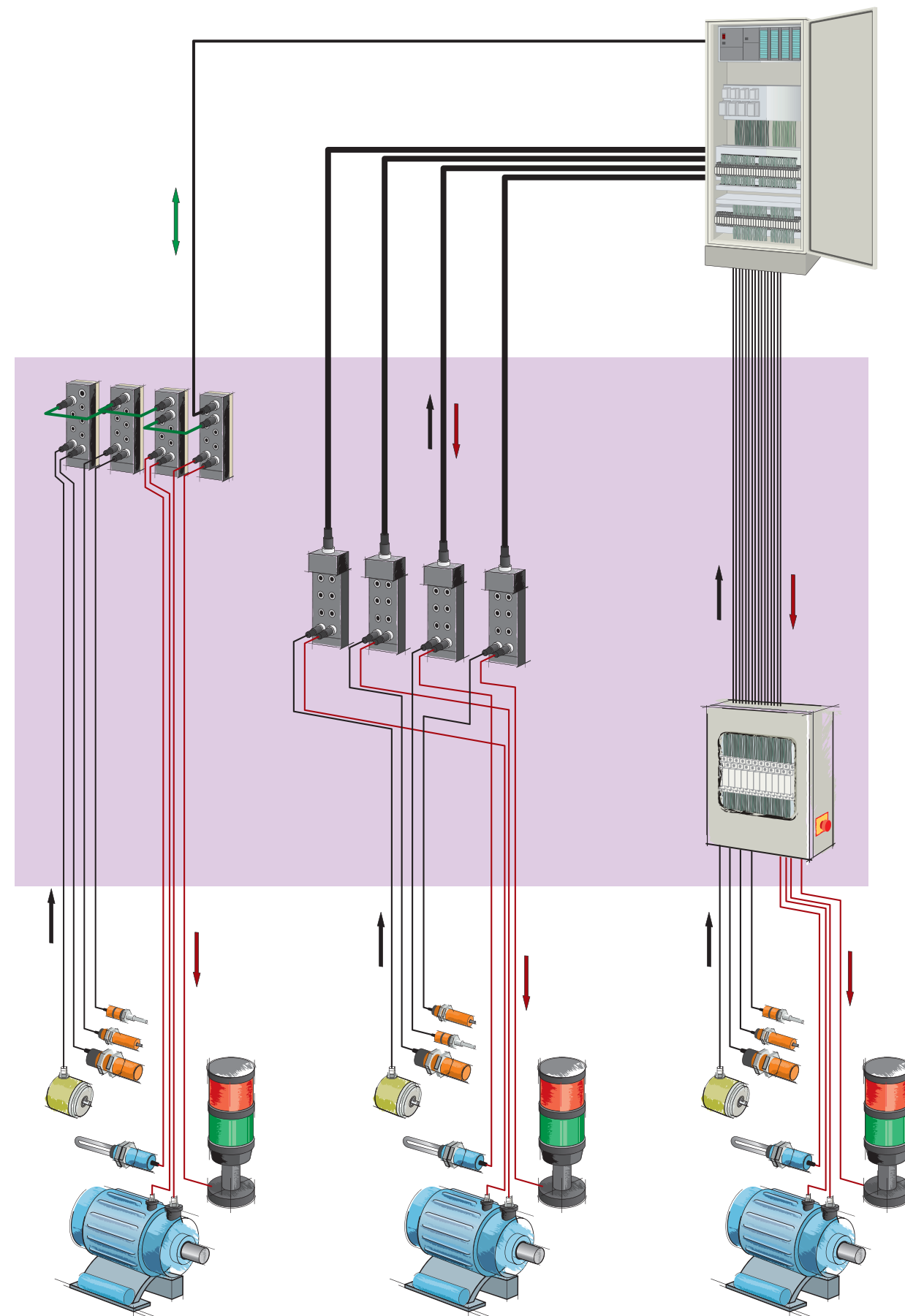

## Type designation UNITRONIC® Fieldbus

### 1. S/A cabling



S/A cable

Example 1.1: **AB-C3-M8MS-2,0PUR-M12FA-2L**

<b>AB-C</b>	<b>3</b>	-	<b>M8MS</b>	-	<b>2,0</b>	-	<b>PUR</b>	-	<b>M12FA</b>	-	<b>2L</b>	-	<b>SH</b>
Automation bus cordset	Number of pin		Connection left		Cable length in m		Material of cable		Connection right		Number of LEDs		shielded Version
	3		M8MS (M8 connector straight)		0,3		PUR		M8FA (M8 socket angled)		2L		
	4		M12MS (M12 connector straight)		0,6		PVC		M8FS (M8 socket straight)		3L		
	5				1,0				<b>M12FA (M12 socket angled)</b>				
	8				2,0				M12FS (M12 socket straight)				
					...								

<b>Automation bus Power cable</b>	
AB-PC	4

Example 1.2: **AB-C3-M12MS-0,3PUR-A-1L-S**



Valve connector

<b>AB-C</b>	<b>3</b>	-	<b>M12MS</b>	-	<b>0,3</b>	-	<b>PUR</b>	-	<b>A</b>	-	<b>1L</b>	-	<b>S</b>
Automation bus cordset	Number of pin		Connection left		Cable length in m		Material of cable		Type of valve connector		Number of LEDs		with protection
	3		M12MS (M12 connector straight)		0,3		PUR		<b>A (Type A)</b>		1L		<b>S (Z diode)</b>
	4				0,6				AD (Type AD)		2L		SV (Varistor)
	5				1,0				B (Type B)				
	8				2,0				BI (Type BI)				
					...				C (Type C)				
					...				CI (Type CI)				

Example 1.3: **AB-C5-M12FS-PG9-SH**



Connector (field attachable)

<b>AB-C</b>	<b>5</b>	-	<b>M12FS</b>	-	<b>PG9</b>	-	<b>SH</b>
Automation bus cordset	Number of pin		Connectors		Cable connection		shielded Version
	3		M8MS (M8 connector straight)		PG7		SH
	4		M8FS (M8 socket straight)		<b>PG9</b>		
	5		M12MS (M12 connector straight)		F0,34 (fast connect, max. 0.34 mm² conductor cross-section)		
			M12MA (M12 connector angled)		F0,75 (fast connect, max. 0.75 mm² conductor cross-section)		
			<b>M12FS (M12 socket straight)</b>		P (Piercing)		
			M12FA (M12 socket angled)		M16 – 0,5 (flush-type connector with 0.5 m PUR litz wire)		
					PG9 – 0,5 (flush-type connector with 0.5 m PUR litz wire)		
					PG9 – 0,5 (flush-type connector M8 with 0.5 m PUR litz wire)		
					PG9/M16-PO-0,5 (flush-type connector, can be positioned with 0.5 m PUR litz wire)		

**DSI**  
Mounting type (flush-type connector)  
DSI (Data Socket Inside – rear mounting)

### 2. S/A box passiv



Example 2.1: **AB-B8-M12L-16-10,0PUR**

<b>AB-B</b>	<b>8</b>	-	<b>M12</b>	-	<b>L</b>	-	<b>16</b>	-	<b>10,0</b>	-	<b>PUR</b>
Automation bus-Box	Number of slots		S/A connection		LED		Number of inputs/outputs		Master cable connection		Material of cable
	4		M8		L		4		5,0 (5.0 m length of master cable)		PUR
	6		M12				6		<b>10,0 (10.0 m length of master cable)</b>		
	8						8		C (pluggable, for master cable bulk stock)		
	10						10		M12 (M12 master cable connection)		
							12		M16 (M16 master cable connection)		
							16				

### 3. S/A box active



Example 3.1: **AB-ASI-DI4DO4-M12-2A**

<b>AB-</b>	<b>ASI</b>	-	<b>DI4</b>	-	<b>DO4</b>	-	<b>2A</b>
Automation bus	Interface		Digital inputs		Digital outputs		max. output current each channel
	<b>ASI (AS-Interface)</b>		2		2		0.5A
	PB (PROFIBUS)		4		3		2A
	CAN (CANopen)		8		4		3A
	DN (DeviceNet)		16		8		
					R4 (4 outputs (relay contacts))		

### 4. Pre-assembled bus cables



Example 4.1: **AB-PB-M12MS-10,0PUR-M12FS**

<b>AB-</b>	<b>PB</b>	-	<b>M12MS</b>	-	<b>10,0</b>	-	<b>PUR</b>	-	<b>M12FS</b>
Automation bus	Interface		Connection left		Cable length in m		Material of cable		Connection right
	<b>PB (PROFIBUS)</b>		M12MS (M12 connector straight)		0,3		PUR		M12FS (M12 socket straight)
	CAN (CANopen)		M12MA (M12 connector angled)		0,6				M12FA (M12 socket angled)
	DN (DeviceNet)				1,0				
					...				
					10,0				



Worldwide connections. We deliver them with systems.

**1** UNITRONIC®  
Data Communication Systems

**2** UNITRONIC® LAN  
LAN Cables for building

**3** HITRONIC®  
Glass Optical Fibre (GOF)

**4** ETHERLINE®  
LAN Cables for industry

**5** SILVYN®  
Protective Cable Conduit Systems

**6** ÖLFLEX®  
Servo Cables, Harnessings

**7** ÖLFLEX®  
Halogen-free Connection  
and Control Cables

**8** FLEXIMARK®  
Marking Systems

**9** UNITRONIC® BUS  
Bus Cables

**10** HITRONIC®  
Polymer Optical Fibre (POF)  
Plastic Cladded Fiber (PCF)

**11** SILVYN® CHAIN  
Chain Systems

**12** UNITRONIC® Feldbus  
Fieldbus Systems

**13** EPIC®  
Rectangular Connectors

**14** SKINTOP®  
Cable Entry Systems

**15** EPIC®  
Circular Connectors

**16** ÖLFLEX®  
Single Cores, Ground Straps

**17** ÖLFLEX®  
ROBOT Cables

**18** ÖLFLEX®  
CRANE F Cables

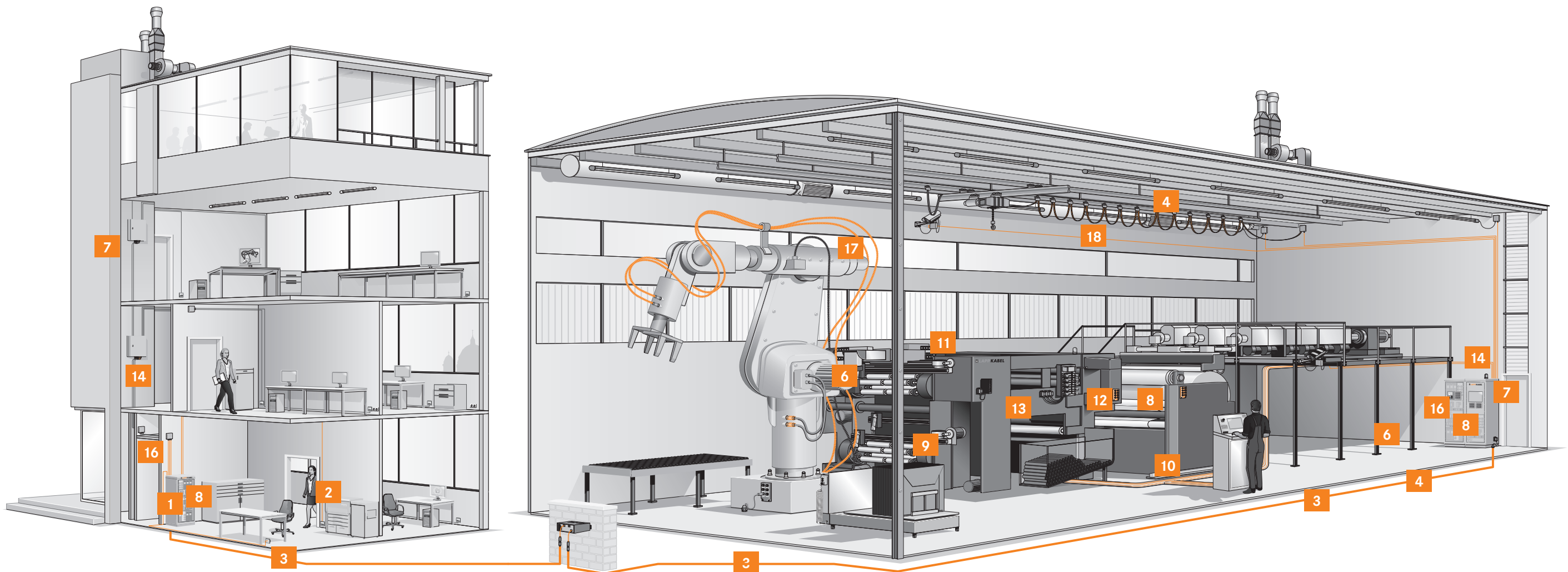

## 1a. Sensor/actuator cordsets



S/A selector	M8 connector										M12 connector								M12 connector shielded (SH)						Free conductor end to the direct connection at field attachable connectors		Page													
	straight (M8MS)					angled (M8MA)					straight (M12MS)				angled (M12MA)				straight (M12MS ... SH)																					
	3-pin		4-pin			3-pin		4-pin			3-pin		4-pin		5-pin		8-pin		3-pin		4-pin		5-pin																	
	Article number	Page	Article number	Page	Article number	Page	Article number	Page	Article number	Page	Article number	Page	Article number	Page	Article number	Page	Article number	Page	Article number	Page	Article number	Page	Article number	Page				Article number	Page											
S/A cable with free conductor end to the direct connection at: - sensors/actuators and - field attachable connectors	2.0 m	22260204	84	22260300	90	22260053	84	22260056	90	22260221	81	22260320	87	22260400	92	22260091	95	22260223	81	22260301	87	22260402	92	22260094	*	22260453	96	22260459	96	22260465	96									
	5.0 m	22260205	84	22260308	90	22260987	84	22260057	90	22260222	81	22260321	87	22260401	92	22260092	95	22260224	81	22260302	87	22260403	92	22260095	*	22260454	96	22260460	96	22260466	96									
	10.0 m	22260218	84	22260318	90	22260055	84	22260058	90	22260249	81	22260342	87	22260414	92	22260093	95	22260256	81	22260303	87	22260417	92	22260096	*	22260455	96	22260461	96	22260467	96									
M8 socket	straight socket (M8FS)	3-pin	0.3 m	22260206	85	<b>Example:</b> S/A cable, 3-pos., PUR halogen-free BK, straight M8 plug, on straight M8 socket, l = 0.3 m (AB-C3-M8MS-0,3PUR-M8FS)					22260225	83																	2.0 m	22260202	84									
			0.6 m	22260207	85						22260226	83																	5.0 m	22260200	84									
			1.0 m	22260208	85						22260227	83																	10.0 m	22260219	84									
			2.0 m	22260209	85						22260228	83																												
	4-pin	0.3 m		22260313	91						22260347	89																	2.0 m	22260309	90									
		0.6 m		22260314	91						22260349	89																	5.0 m	22260310	90									
		1.0 m		22260315	91						22260350	89																	10.0 m	22260317	90									
		2.0 m		22260316	91						22260348	89																												
	angled socket (M8FA)	3-pin	0.3 m	22260210	85						22260229	83																	2.0 m	22260203	84									
			0.6 m	22260211	85						22260230	83																	5.0 m	22260201	84									
			1.0 m	22260212	85						22260231	83																	10.0 m	22260220	84									
			2.0 m	22260213	85						22260232	83																												
	4-pin	0.3 m				22260059	91																						2.0 m	22260311	90									
		0.6 m				22260060	91																						5.0 m	22260312	90									
		1.0 m				22260061	91																						10.0 m	22260319	90									
		2.0 m				22260062	91																																	
angled socket with LEDs (M8FA-2L)	3-pin	0.3 m	22260214	85						22260267	83																	2.0 m	22260275	84										
		0.6 m	22260215	85						22260268	83																	5.0 m	22260276	84										
		1.0 m	22260216	85						22260269	83																	10.0 m	22260277	84										
		2.0 m	22260217	85						22260270	83																													
M12 socket	straight socket (M12FS)	3-pin	0.3 m	22260241	86						22260233	82																	2.0 m	22260257	81									
			0.6 m	22260242	86						22260234	82																	5.0 m	22260250	81									
			1.0 m	22260243	86						22260235	82																	10.0 m	22260251	81									
			2.0 m	22260244	86						22260236	82																												
	4-pin	0.3 m							22260328	88						22260304	88																	2.0 m	22260322	87				
		0.6 m							22260329	88						22260305	88																	5.0 m	22260323	87				
		1.0 m							22260330	88						22260306	88																	10.0 m	22260343	87				
		2.0 m							22260331	88						22260307	88																							
	5-pin	0.3 m									22260410	93																						2.0 m	22260404	92				
		0.6 m									22260411	93																						5.0 m	22260405	92				
		1.0 m									22260412	93																						10.0 m	22260415	92				
		2.0 m									22260413	93																												
	8-pin	0.3 m													22260097	95																						2.0 m	22260726	94
		0.6 m													22260098	95																						5.0 m	22260728	94
		1.0 m													22260099	95																						10.0 m	22260729	94
		2.0 m													22260042	95																								
	straight socket with LEDs (M12FS-2L)	3-pin	0.3 m																													2.0 m	22260252	81						
			0.6 m																											5.0 m	22260265	81								
			1.0 m																											10.0 m	22260266	81								
			2.0 m																																					
4-pin	0.3 m																													2.0 m	22260344	87								
	0.6 m																												5.0 m	22260345	87									
	1.0 m																												10.0 m	22260346	87									
	2.0 m																																							

See continuation page 37

Please see detailed technical information on the data sheet ([www.lappgroup.com/products](http://www.lappgroup.com/products)).



## 1b. Selector: M8/M12 connectors (field attachable) – sensor cable

Connectors							Sensor cable																								
							UNITRONIC® SENSOR										UNITRONIC® SENSOR FD UL/AWM						UNITRONIC® SENSOR FD shielded			UNITRONIC®					
							S-LiYY (3x0,25)	S-LiYY (3x0,34)	S-LiYY (4x0,25)	S-LiYY (4x0,34)	DESINA (4x0,34)	S-LiYY1Y (4x0,34)	S-LiY1Y (5x0,25)	LiY1Y (3x0,25)	LiY1Y (3x0,34)	LiY1Y (4x0,25)	LiY1Y (4x0,34)	LiY1Y (5x0,25)	LiY1Y (5x0,34)	LiY1Y (8x0,25)	LiY1Y (3x0,34)	LiY1Y (4x0,34)	LiY1Y (5x0,34)	LiYY 4x0,75	LiYY 5x0,75	LiYCY 4x0,75	LiYCY 5x0,75	LiYCY 8x0,25	FD CP plus 5x0,25)	FD CP plus 5x0,34)	
Outer diameter [mm]	4.2	4.8	4.5	4.8	5.2	4.8	4.9	4,4	4.6	4,7	4.7	5.1	4.7	5.9	4,6	4,7	5,1	6.1	6.9	7.0	7.6	7.1	6.2	6.8							
Article number	7038883	7038859	7038884	7038860	0040434	7038861	7038862	7038883	7038864	7038884	7038865	7038866	7038867	7038868	7038885	7038886	7038887	0028604	0028605	0034704	0034705	0034408	0028892	0028901							
Connection	Number of pin	Version	Connection type	Conductor cross-section [mm²]	Cable diameter [mm]	Article number	Page	115	115	115	115	115	115	115	115	115	115	115	115	115	115	115	115	115							
M8	3-pin	socket, straight	Screw	0.14 - 0.5	3.5 - 5.0	22260125	114	X	X					X	X																
		connector, straight	Screw	0.14 - 0.5	3.5 - 5.0	22260120	114	X	X					X	X																
		socket, straight	Piercing	0.14 - 0.38	3.0 - 5.0	22260124	114	X	X					X	X																
		connector, straight	Piercing	0.14 - 0.38	3.0 - 5.0	22260122	114	X	X					X	X																
		socket, straight	IDC	0.08 - 0.25	2.5 - 5.0	22260994	114	X						X																	
		socket, straight	IDC	0.25 - 0.5	2.5 - 5.0	22260986	114	X	X					X	X																
		connector, straight	IDC	0.08 - 0.25	2.5 - 5.0	22260993	114	X						X																	
	connector, straight	IDC	0.25 - 0.5	2.5 - 5.0	22260985	114	X	X					X	X																	
	4-pin	socket, straight	Screw	0.14 - 0.5	3.5 - 5.0	22260126	114			X						X	X														
		connector, straight	Screw	0.14 - 0.5	3.5 - 5.0	22260121	114			X						X	X														
		socket, straight	IDC	0.08 - 0.25	2.5 - 5.0	22260045	114			X						X															
		socket, straight	IDC	0.25 - 0.5	2.5 - 5.0	22260046	114			X	X					X	X														
		connector, straight	IDC	0.08 - 0.25	2.5 - 5.0	22260043	114			X						X															
		connector, straight	IDC	0.25 - 0.5	2.5 - 5.0	22260044	114			X	X					X	X														
socket, straight		Piercing	0.14 - 0.38	3.5 - 5.0	22260119	114			X	X					X	X															
connector, straight	Piercing	0.14 - 0.38	3.0 - 5.0	22260123	114			X	X					X	X																
M12	4-pin	socket, straight	Screw	0.25 - 0.75	4.0 - 6.0	22260640	113			X	X					X															
		socket, straight	Screw	0.25 - 0.75	6.0 - 8.0	22260641	113												X		X										
		socket, angled	Screw	0.25 - 0.75	4.0 - 6.0	22260636	113			X	X					X															
		connector, straight	Screw	0.25 - 0.75	4.0 - 6.0	22260649	113			X	X					X															
		connector, angled	Screw	0.25 - 0.75	6.0 - 8.0	22260995	113												X		X										
		socket, angled	Screw	0.25 - 0.75	4.0 - 6.0	22260647	113			X	X					X															
		connector, straight	IDC	0.14 - 0.34	3.5 - 6.0	22260131	113				X	X	X			X															
	socket, straight	IDC	0.34 - 0.75	4.0 - 8.0	22260133	113			X	X	X				X																
	connector, straight	IDC	0.14 - 0.34	3.5 - 6.0	22260132	113			X	X	X				X																
	connector, straight	IDC	0.34 - 0.75	4.0 - 8.0	22260134	113			X	X	X				X																
	5-pin	socket, straight	Screw	0.25 - 0.75	4.0 - 6.0	22260127	113						X			X	X														
		socket, straight	Screw	0.25 - 0.75	6.0 - 8.0	22260644	113													X		X									
		socket, straight	SKINTOP®	0.25 - 0.75	6.0 - 8.0	22260997	113													X		X									
		socket, angled	Screw	0.25 - 0.75	4.0 - 6.0	22260128	113						X			X	X														
socket, angled		Screw	0.25 - 0.75	6.0 - 8.0	22260638	113						X			X	X															
connector, straight		Screw	0.25 - 0.75	4.0 - 6.0	22260129	113						X			X	X															
connector, straight		Screw	0.25 - 0.75	6.0 - 8.0	22260651	113														X		X									
connector, straight		SKINTOP®	0.25 - 0.75	6.0 - 8.0	22260996	113														X		X									
connector, angled		Screw	0.25 - 0.75	4.0 - 6.0	22260130	113						X			X	X															
connector, angled		Screw	0.25 - 0.75	6.0 - 8.0	22260648	113									X	X															
8-pin	connector, straight, shielded	Screw	0.25 - 0.75	6.0 - 8.0	22260135	113													X		X		X	X							
	socket, straight, shielded	Screw	0.25 - 0.75	6.0 - 8.0	22260136	113													X		X		X	X							
	connector, straight, shielded	Screw	0.25 - 0.75	6.0 - 8.0	22260825	113													X				X	X							
	socket, straight, shielded	Screw	0.25 - 0.75	6.0 - 8.0	22260826	113													X				X	X							

### Legend

\*see [www.lappgroup.com/products](http://www.lappgroup.com/products)

Please see detailed technical information on the data sheet ([www.lappgroup.com/products](http://www.lappgroup.com/products)).



1c. Valve connectors



S/A

Connectortype		with M12 connector straight					Free conductor end to the direct connection at field attachable connectors				
Article designation	Version	Length	3-pos.	Page	5-pos.	Page	Length	3-pos.	Page	5-pos.	Page
Type A (18 mm)	PE bridged with 1 LED and protective circuit (Z diode) PUR cable	0.3 m	22260550	104			2.0 m	22260584	104		
		0.6 m	22260551	104			5.0 m	22260576	104		
		1.0 m	22260552	104			10.0 m	22260577	104		
		2.0 m	22260553	104							
Type B (10 mm)		0.3 m	22260558	104			2.0 m	22260585	104		
		0.6 m	22260559	104			5.0 m	22260578	104		
		1.0 m	22260560	104			10.0 m	22260579	104		
		2.0 m	22260561	104							
Type BI (11 mm)		0.3 m	22260554	104			2.0 m	22260586	104		
		0.6 m	22260555	104			5.0 m	22260580	104		
		1.0 m	22260556	104			10.0 m	22260581	104		
		2.0 m	22260557	104							
Type C (8 mm)		0.3 m	22260566	104			2.0 m	22260587	104		
		0.6 m	22260567	104			5.0 m	22260582	104		
		1.0 m	22260568	104			10.0 m	22260583	104		
		2.0 m	22260569	104							
Type CI (9.4 mm)	0.3 m	22260562	104			2.0 m	22260588	104			
	0.6 m	22260563	104			5.0 m	22260574	104			
	1.0 m	22260564	104			10.0 m	22260575	104			
	2.0 m	22260565	104								
Type AD (18 mm)	for pressure switch 2 LEDs PUR cable	0.3 m			22260573	104	2.0 m			22260589	104
		0.6 m			22260572	104	5.0 m			22260590	104
		1.0 m			22260571	104	10.0 m			22260591	104
		2.0 m			22260570	104					



Suitable field attachable connectors (screw connection)				
		Connector	Article number	Page
M8	3-pos.	Connector straight	22260120	114
	4-pos.	Connector straight	22260134	113
M12	5-pos.	Connector straight	22260129	113
		Connector angled	22260130	113

## 1d. Selector: Flush-type connectors

		Flush-type connector with 0.5 m PUR single liz						
		Connection	Number of poles	Mounting type	Article designation	Article number	Page	
Front mounting	M8 socket		3	M8 x 0.5 (SW 10 mm)	AB-C3-M8FS-0,5	22260102	118	
			4		AB-C4-M8FS-0,5	22260103	118	
		M8 connector			3	AB-C3-M8MS-0,5	22260100	118
					4	AB-C4-M8MS-0,5	22260101	118
	M12 socket		4	M16 x 1.5 (SW 17 mm)	AB-C4-M12FS-M16-0,5	22260107	116	
			4	M16 x 1.5 (SW 17 mm)	AB-C4-M12FS-M16-PO-0,5	22260085	116	
			4	PG9 (SW 17 mm)	AB-C4-M12FS-PG9-0,5	22260114	116	
			4	PG9 (SW 17 mm)	AB-C4-M12FS-PG9-PO-0,5	22260089	116	
			5	M16 x 1.5 (SW 17 mm)	AB-C5-M12FS-M16-0,5	22260105	116	
			5	M16 x 1.5 (SW 17 mm)	AB-C5-M12FS-M16-PO-0,5	22260086	116	
			5	PG9 (SW 17 mm)	AB-C5-M12FS-PG9-0,5	22260111	116	
			5	PG9 (SW 17 mm)	AB-C5-M12FS-PG9-PO-0,5	22260090	116	
		M12 connector		4	M16 x 1.5 (SW 17 mm)	AB-C4-M12MS-M16-0,5	22260108	116
				4	M16 x 1.5 (SW 17 mm)	AB-C4-M12MS-M16-PO-0,5	22260083	116
			4	PG9 (SW 17 mm)	AB-C4-M12MS-PG9-0,5	22260113	116	
			4	PG9 (SW 17 mm)	AB-C4-M12MS-PG9-PO-0,5	22260087	116	
			5	M16 x 1.5 (SW 17 mm)	AB-C5-M12MS-M16-0,5	22260106	116	
			5	M16 x 1.5 (SW 17 mm)	AB-C5-M12MS-M16-PO-0,5	22260084	116	
Rear mounting	M12 socket		4	PG9 (SW 17 mm)	AB-C4-DSI-M12FS-PG9-0,5	22260118	116	
			5	PG9 (SW 17 mm)	AB-C5-DSI-M12FS-PG9-0,5	22260116	116	
	M12 connector		4	PG9 (SW 17 mm)	AB-C4-DSI-M12MS-PG9-0,5	22260117	116	
			5	PG9 (SW 17 mm)	AB-C5-DSI-M12MS-PG9-0,5	22260115	116	

Suitable fitting nut		
SW [mm]	Article number	Page
10	22260104	118
19	22260110	118
18	22260109	118
19	22260110	118
18	22260109	118
19	22260110	118
18	22260109	118
18	included	
18	included	
18	included	
18	included	

Suitable S/A connection		
Number of poles	straight connector	angled connector
3	C3-M8MS	C3-M8MA
4	C4-M8MS	C4-M8MA
3	C3-M8FS	C3-M8FA
4	C4-M8FS	C4-M8FA
4	C4-M12MS	C4-M12MA
5	C5-M12MS	C5-M12MA
4	C4-M12FS	C4-M12FA
5	C5-M12FS	C5-M12FA
4	C4-M12MS	C4-M12MA
5	C5-M12MS	C5-M12MA
4	C4-M12FS	C4-M12FA
5	C5-M12FS	C5-M12FA

S/A

## 2. Selector: Structured Fieldbus wiring for passive S/A distribution box to PLC I/O

S/A connection (box)						Status indication (box)	Characteristics of S/A distribution box	Article designation	Article number						
Socket**	Number of S/A slots	S/A type of signal	PE-connection	Pins than a single slot	S/A box incl. master cable				S/A box incl. master cable						
									5.0 m	Page	10.0 m	Page			
M12	4	2-/3-wire, PNP	x	simply	S/A distribution box M12 with <b>fixed assembled master cable</b> , PUR, metal thread with quick locking system, drag chain suitable	AB-B4-M12L-4-x,yPUR	22260018	107	22260019	107					
	4	2-/3-/4-wire, PNP	x	double		AB-B4-M12L-8-x,yPUR	22260020	107	22260021	107					
	4	2-/3-wire, PNP/NPN	x	simply		AB-B4-M12-4-x,yPUR	22260010	107	22260011	107					
	4	2-/3-/4-wire, PNP/NPN	x	double		AB-B4-M12-8-x,yPUR	22260012	107	22260013	107					
	6	2-/3-wire, PNP	x	simply		AB-B6-M12L-6-5.0PUR	22260970	107							
	8	2-/3-wire, PNP	x	simply		AB-B8-M12L-8-x,yPUR	22260022	107	22260023	107					
	8	2-/3-/4-wire, PNP	x	double		AB-B8-M12L-16-x,yPUR	22260024	107	22260025	107					
	8	2-/3-wire, PNP/NPN	x	simply		AB-B8-M12-8-x,yPUR	22260014	107	22260015	107					
M8	4	2-/3-wire, PNP		simply	S/A distribution box M8 with <b>fixed assembled master cable</b> , PUR, metal thread, drag chain suitable	AB-B4-M8L-4-x,yPUR	22260026	105	22260027	105					
	6	2-/3-wire, PNP				AB-B6-M8L-6-x,yPUR	22260028	105	22260029	105					
	8	2-/3-wire, PNP				AB-B8-M8L-8-x,yPUR	22260030	105	22260031	105					
	10	2-/3-wire, PNP				AB-B10-M8L-10-x,yPUR	22260032	105	22260033	105					
M8	4	2-/3-wire, PNP		simply	S/A distribution box M8 and <b>master cable connection M16</b>	AB-B4-M8L-4-M16	22260034	106	22260607	110	22260608	110			
	6	2-/3-wire, PNP				AB-B6-M8L-6-M16	22260035	106	22260609	110	22260610	110			
	8	2-/3-wire, PNP				AB-B8-M8L-8-M16	22260036	106	22260611	110	22260612	110			
	10	2-/3-wire, PNP				AB-B10-M8L-10-M16	22260037	106	22260613	110	22260614	110			
	4	2-/3-wire, PNP				S/A distribution box M8 and <b>master cable connection M12</b>	AB-B4-M8L-4-M12	22260038	106	22260615	111	22260616	111		
	6	2-/3-wire, PNP				AB-B6-M8L-6-M12	22260039	106	22260615	111	22260616	111			
M12	4	2-/3-wire, PNP/NPN	x	simply	S/A distribution box M12 with <b>pluggable master cable connection</b> , metal thread with quick locking system, master cable as bulk stock (optional connection hood 22260009)	AB-B4-M12-4-C	22260005	108				7038880	109		
	4	2-/3-wire, PNP	x			AB-B4-M12L-4-C	22260001	108							
	4	2-/3-/4-wire, PNP/NPN	x	double		AB-B4-M12-8-C	22260006	108					7038881	109	
	4	2-/3-/4-wire, PNP	x			AB-B4-M12L-8-C	22260002	108							
	8	2-/3-/4-wire, PNP/NPN	x	simply		AB-B8-M12-8-C	22260007	108							
	8	2-/3-wire, PNP	x			AB-B8-M12L-8-C	22260003	108							
	8	2-/3-/4-wire, PNP/NPN	x	double		AB-B8-M12-16-C	22260008	108						7038882	109
	8	2-/3-/4-wire, PNP	x			AB-B8-M12L-16-C	22260004	108							

Legend: \*\*see www.lappgroup.com/products \*\*Screw plug for unoccupied sockets: M12: 22260605, M8: 22260606. Please see detailed technical information on the data sheet (www.lappgroup.com/products).

PLC

### 3. Selector: Bus-compatible S/A boxes active (IP65/67)

Bus	Digital inputs/outputs						Type of connection (M12)/type of signal			Article designation	Page
	Inputs			Outputs			PNP		max. connectable type of connection (input)		
	4	8	16	4	8	I <sub>max</sub> /channel	Sensor	Actuator			
PROFIBUS	x						2-/3-,4-wire		4x 4-wire 3x 4-wire + 2x 3-/2-wire 2x 4-wire + 4x 3-/2-wire 1x 4-wire + 6x 3-/2-wire 8x 3-/2-wire	AB-PB-DI8-M12 22260738	121
		x					2-/3-,4-wire		8x 4-wire 7x 4-wire + 2x 2-/3-wire 6x 4-wire + 4x 2-/3-wire ... 16x 2-/3-wire	AB-PB-DI16-M12 22260739	121
	x			x		2 A	2-/3-,4-wire	2-/3-wire	2x 4-wire 1x 4-wire + 2x 2-/3-wire 4x 2-/3-wire	AB-PB-DI4DO4-M12-2A 22260740	121
	x				x	0.5 A	2-/3-,4-wire	2-/3-wire	4x 4-wire 3x 4-wire + 2x 3-/2-wire 2x 4-wire + 4x 3-/2-wire 1x 4-wire + 6x 3-/2-wire 8x 3-/2-wire	AB-PB-DI8DO8-M12-0,5A 22260762	121
					x	2 A		2-/3-wire		AB-PB-DO8-M12-2A 22260742	121
DeviceNet	x						2-/3-,4-wire		4x 4-wire 3x 4-wire + 2x 3-/2-wire 2x 4-wire + 4x 3-/2-wire 1x 4-wire + 6x 3-/2-wire 8x 3-/2-wire	AB-DN-DI8-M12 22260743	122
		x					2-/3-,4-wire		8x 4-wire 7x 4-wire + 2x 2-/3-wire 6x 4-wire + 4x 2-/3-wire ... 16x 2-/3-wire	AB-DN-DI16-M12 22260744	122
	x			x		2 A	2-/3-,4-wire	2-/3-wire	2x 4-wire 1x 4-wire + 2x 2-/3-wire 4x 2-/3-wire	AB-DN-DI4DO4-M12-2A 22260745	122
	x				x	0.5 A	2-/3-,4-wire	2-/3-wire	4x 4-wire 3x 4-wire + 2x 3-/2-wire 2x 4-wire + 4x 3-/2-wire 1x 4-wire + 6x 3-/2-wire 8x 3-/2-wire	AB-DN-DI8DO8-M12A-0,5A 22260763	122
					x	2 A		2-/3-wire		AB-DN-DO8-M12-2A 22260747	122
CANopen	x						2-/3-,4-wire		4x 4-wire 3x 4-wire + 2x 3-/2-wire 2x 4-wire + 4x 3-/2-wire 1x 4-wire + 6x 3-/2-wire 8x 3-/2-wire	AB-CAN-DI8-M12 22260748	123
			x				2-/3-,4-wire		8x 4-wire 7x 4-wire + 2x 2-/3-wire 6x 4-wire + 4x 2-/3-wire ... 16x 2-/3-wire	AB-CAN-DI16-M12 22260749	123
	x			x		2 A	2-/3-,4-wire	2-/3-wire	2x 4-wire 1x 4-wire + 2x 2-/3-wire 4x 2-/3-wire	AB-CAN-DI4DO4-M12-2A 22260750	123
	x				x	0.5 A	2-/3-,4-wire	2-/3-wire	4x 4-wire 3x 4-wire + 2x 3-/2-wire 2x 4-wire + 4x 3-/2-wire 1x 4-wire + 6x 3-/2-wire 8x 3-/2-wire	AB-CAN-DI8DO8-M12A-0,5A 22260764	123
					x	2 A		2-/3-wire		AB-CAN-DO8-M12-2A 22260752	123



Length	Pre-assembled bus cables double-sided		Pre-assembled bus cables single-sided				Bus cable as bulk stock	Suitable M12 connector		Suitable EPIC® data connector (9-pos. D-Sub.)		PLC interface
	M12 connector on M12 socket		M12 connector on free conductor end		M12 socket on free conductor end			Article number	Page	Article number	Page	
	Article number	Page	Article number	Page	Article number	Page						
0.2 m	22260955						see UNITRONIC® bus cables	M12 socket 22260646	133	21700507 (35°)	69	PROFIBUS
0.3 m	22260773					21700506 (35°, PG)				69		
1 m	22260774		22260767		22260770	21700504 (90°)				69		
2 m	22260775	130	22260768	129	22260771	21700503 (90°, PG)				69		
5 m	22260776		22260769		22260772	21700530 (90°, LED)				69		
10 m	22260777					21700529 (90°, PG, LED)				69		
15 m	22260907					21700543 (90°, ATEX)				71		
20 m	22260908					21700542 (90°, PG, ATEX)	71					
										21700505 (AX)	69	
0.3 m	22260795						see UNITRONIC® bus cables	M12 socket 22260135	133	21700537 (90°)	80	DeviceNet
1 m	22260796		22260789		22260792	21700536 (90°, PG)						
2 m	22260797	132	22260790	131	22260793	21700538 (AX)						
5 m	22260798		22260791		22260794							
10 m	22260799											
0.3 m	22260795						see UNITRONIC® bus cables	M12 socket 22260135	133	21700537 (90°)	80	CANopen
1 m	22260796		22260789		22260792	21700536 (90°, PG)						
2 m	22260797	132	22260790	131	22260793	21700538 (AX)						
5 m	22260798		22260791		22260794							
10 m	22260799											

PLC

Power connection cable\*\* (power cable) for external and operation voltage

S/A box	Length	M12 connector straight on M12 socket straight		M12 connector straight on free conductor end		M12 socket straight on free conductor end	
		Article number	Page	Article number	Page	Article number	Page
PROFIBUS DeviceNet CANopen	0.3 m	22260784	138				
	1 m	22260785	138				
	2 m	22260786	138	22260778	137	22260781	137
	5 m	22260787	138	22260779	137	22260782	137
	10 m	22260788	138	22260780	137	22260783	137

Legend

\*see [www.lappgroup.com/products](http://www.lappgroup.com/products)  
 \*\*One operation voltage supply is needed for DI boxes  
 Operation voltage and external supply voltage is needed for DI/DO boxes  
 Special cable lengths, other outer sheath materials (e.g. PVC) and individual connector types on request.  
 Please see detailed technical information on the data sheet ([www.lappgroup.com/products](http://www.lappgroup.com/products)).

## 4. Selector: Bus-compatible S/A boxes active (IP30/IP67)

PLC interface	Digital inputs/outputs							Type of connection/ type of signal			S/A distribution box (active), AS-Interface					Distributor on AS-Interface								Bus cable as bulk stock				
	Inputs				Outputs			PNP			Article designation	Article number	Page	Product features	Type of connection	for 1 AS-Interface flat cable				for 2 AS-Interface flat cable								
	2	4	8	2	3	4	8	I <sub>max</sub> /channel	Sensor	Actuator						1 m	2 m	5 m	10 m	1 m	2 m	5 m	10 m					
AS-Interface		x							3 A	2-/3-wire	2-/3-wire	AB-ASI-DI4DOR4-3A	22260807	120	AS-Interface module (IP30), LED, metal housing, plug-in connection	Screw/tension plug terminal (see table AS-Interface network components (AB-ASI-XS/AB-ASI-XT))												see UNITRONIC® bus cable
		x							2 A	2-/3-wire	2-/3-wire	AB-ASI-DI4DO4-2A	22260808	120					22260800 & Power cable (22260778) see page 137	22260800 & Power cable (22260779) see page 137	22260800 & Power cable (22260780) see page 137			22260801 & Power cable (22260778) see page 137	22260801 & Power cable (22260779) see page 137	22260801 & Power cable (22260780) see page 137		
				x						2 A	2-/3-wire	2-/3-wire	AB-ASI-DI8DO8-2A	22260809			120											
		x								1 A	2-/3-wire	2-/3-wire	AB-ASI-M12-DI4DO4-M8-1A	22260759	119	AS-Interface module (IP67), LED, metal thread	3-pos. M8	22260803 see page 124	22260804 see page 124				22260805 see page 124	22260806 see page 124				
		x			x					2A	2-/3-/4-wire	2-/3-wire	AB-ASI-DI2DO2-M12-2A	22260755	119			4-pos. M12	integrated bus connection (UNITRONIC® BUS AS-I)									
		x				x				2 A	2-/3-/4-wire	2-/3-wire	AB-ASI-DI4DO3-M12-2A	22260756	119													
	x								2 A	2-/3-/4-wire	2-/3-wire	AB-ASI-DI4DO4-M12-2A	22260757	119														

### Legend

\*\*Relay contact  
Please see detailed technical information on the data sheet ([www.lappgroup.com/products](http://www.lappgroup.com/products)).

AS-Interface network components						
Product	Article designation	Article number	Page	Suitable accessories	Article number	Page
AS-Interface network extension with LED diagnostic	AB-ASI-NE200LED	22260813	127	Distributor M12 on AS-Interface bus cable	22260800	124
AS-Interface network extension with remote diagnostic	AB-ASI-NE200	22260814				
AS-Interface counter module	AB-ASI-C	22260810	125	Screw plug terminal (4x4 pos.)	22260817	128
				Tension plug terminal (4x4 pos.)	22260818	
AS-Interface power supply	AB-ASI-PS-1A	22260812	126			
AS-Interface clip clamp	ASI-clip clamp	61825000	*			
AS-Interface end sealing	AB-ASI-PC-BK	22260047	*			
H-Distributor	AB-ASI-J-Y-Y-N	22260802	124			
Screw plug terminal (4x4 pos.)	AB-ASI-XS4	22260817	128			
Screw plug terminal (2x16 pos.)	AB-ASI-XS16	22260815	128			
Tension plug terminal (4x4 pos.)	AB-ASI-XT4	22260818	128			
Tension plug terminal (8x4 pos.)	AB-ASI-XT16	22260816	128			
SKINTOP® cable glands, black, M20	SKINTOP® ST-M 20x1,5 BK	53111220	*	SKINTOP® DIX-M ASI M20, seals for 1 AS-Interface bus cable	53611001	*
SKINTOP® cable glands, black, M25	SKINTOP® ST-M 25x1,5 BK	53111230	*	SKINTOP® DIX-M ASI DUO M25, seals for 2 AS-Interface bus cables	53611004	*
				SKINTOP® DIX-M RJ45 M25, seals for pre-assembled cable with RJ-45 connector	53440980	*
SKINTOP® cable glands, black, M32	SKINTOP® ST-M 32x1,5 BK	53111240	*	SKINTOP® DIX-M Fieldbus M32, seals for pre-assembled S/A cable	53440970	*

### Legend

\*see [www.lappgroup.com/products](http://www.lappgroup.com/products)  
Please see detailed technical information on the data sheet ([www.lappgroup.com/products](http://www.lappgroup.com/products)).





**New**

## UNITRONIC® BUS ASI

**Info**

- "LD" = Long Distance



**Benefits**

- The new BUS ASI LD 2 x 2.5 (Long Distance) allows even modules located further away to be connected. AS-I power supplies can be reduced. The BUS ASI LD is downwards-compatible with version 1.5.
- The rubber versions are halogen-free

**Application range**

- Communication at sensor/actuator level
- UNITRONIC® Fieldbus sensor-/actuator wiring
- For fixed installation as well as occasional flexing at free, non-continuously recurring movement without tensile load
- The TPE version has an oil-resistant outer sheath. It is suitable for wet areas, in particular in conjunction with water-soluble cooling lubricants.

**Product features**

- Data and power are transmitted via an unshielded, geometrically coded two-core flat cable (protection against polarity reversal).
- The conductor is contacted by "piercing technology" within the ASI modules.
- The sensors are connected to the ASI modules (coupling modules) using round cables (connection cables).

**Norm references / Approvals**

- ASI is standardised Europe-wide in EN 50295 and internationally in IEC 62026-2.
- PVC version has UL/CSA (CMG) approval.
- UL/CSA version: CMGc(UL)us or (UL)CL2 or AWM 300V FT4 approval

**Design**

- Extra-fine wire, tinned copper strands
- Core insulation: blue and brown
- Profiled outer sheath made of rubber (G), thermoplastic elastomers (TPE) or PVC
- Colour: yellow (RAL 1023) or black (RAL 9005)
- Colour: red (RAL 3000)

**Technical data**

- Peak operating voltage**  
Yellow: 300 V (not for power applications)  
Black: 300 V (not for power applications)  
Red: 300 V
- Conductor resistance**  
1.5 mm<sup>2</sup>: max. 13.7 Ohm/km  
2.5 mm<sup>2</sup>: max. 8.21 Ohm/km
- Minimum bending radius**  
Fixed installation: 12 mm  
Flexible use 24 mm
- Test voltage**  
Core/core: 2000 V
- Temperature range**  
Dependent on outer sheath material:  
PVC: -30°C to +90°C  
Other materials: -40°C to +85°C  
During installation:  
PVC -20 °C to +90 °C  
Other materials:  
-30 °C to +85 °C

Article number	Article designation	Outer sheath material	Outer sheath colour	Application	Number of cores and mm <sup>2</sup> per conductor	Copper index (kg/km)	Weight (kg/km)
<b>For fixed and flexible applications (19-wire stranded conductor)</b>							
2170228	UNITRONIC® BUS ASI (G)	EPDM (rubber)	yellow	Data and power transmission	2 x 1,5	29.0	85
2170229	UNITRONIC® BUS ASI (G)	EPDM (rubber)	black	Transmission of 30 V DC auxiliary power	2 x 1,5	29.0	85
2170371	UNITRONIC® BUS ASI LD (G)	EPDM (rubber)	yellow	Data and power transmission	2 x 2,5	48.0	85
2170372	UNITRONIC® BUS ASI LD (G)	EPDM (rubber)	black	Transmission of 30 V DC auxiliary power	2 x 2,5	48.0	85
2170230	UNITRONIC® BUS ASI (TPE)	TPE	yellow	Data and power transmission	2 x 1,5	29.0	64
2170231	UNITRONIC® BUS ASI (TPE)	TPE	black	Transmission of 30 V DC auxiliary power	2 x 1,5	29.0	64
2170232	UNITRONIC® BUS ASI (TPE)	TPE	red	Transmission of 230 V AC auxiliary power	2 x 1,5	29.0	64
2170842	UNITRONIC® BUS ASI (PVC) A	PVC UL/CSA (CMG)	yellow	Data and power transmission	2 x 1,5	29.0	70
2170843	UNITRONIC® BUS ASI (PVC) A	PVC UL/CSA (CMG)	black	Transmission of 30 V DC auxiliary power	2 x 1,5	29.0	70
2170844	UNITRONIC® BUS ASI (PVC) A	PVC UL/CSA (CMG)	red	Transmission of 230 V AC auxiliary power	2 x 1,5	29.0	70

Unless specified otherwise, the shown product values are nominal values. Detailed values (e.g. tolerances) are available upon request. Copper price basis: EUR 150/100kg. Refer to catalogue appendix T17 for the definition and calculation of copper-related surcharges. Please find our standard lengths at: [www.lappkabel.de/en/cable-standardlengths](http://www.lappkabel.de/en/cable-standardlengths) Lapp Kabel is a member of the AS-International Association Photographs are not to scale and do not represent detailed images of the respective products.

**Accessories**

- SKINTOP® DIX-M AUTOMATION refer to page 267
- UNIVERSAL STRIP stripping and cutting tool
- AS-I clip clamp / AS-I end sealing
- AS-I STRIP special stripping tool
- AS-I STRIP special
- SKINTOP® DIX ASI



New

## UNITRONIC® BUS ASI FD

Highly flexible application

LAPP KABEL STUTTGART UNITRONIC® BUS ASI FD

LAPP KABEL STUTTGART UNITRONIC® BUS ASI FD



Info

- “FD” = suitable for power chains
- “LD” = Long Distance

**Benefits**

- The new BUS ASI LD 2 x 2.5 (Long Distance) allows even modules located further away to be connected. AS-I power supplies can be reduced. The BUS ASI LD is downwards-compatible with version 1.5.
- For highly flexible applications (power chains, moving machine parts)
- High oil-resistance

**Application range**

- Communication at sensor/actuator level
- UNITRONIC® Fieldbus sensor-/actuator wiring

**Product features**

- PUR versions are halogen-free according to IEC 60754-1
- Flame-retardant according to IEC 60332-1-2, UL FT-2 flame test
- Data and power are transmitted via an unscreened, geometrically coded two-core flat cable (protection against polarity reversal).
- The conductor is contacted by “piercing technology” within the ASI modules.
- The sensors are connected to the ASI modules (coupling modules) using round cables (connection cables).

**Norm references / Approvals**

- ASI is standardised Europe-wide in EN 50295 and internationally in IEC 62026-2.
- TPE variant: UL AWM Style 2103 CSA AWM II A/B
- PUR versions: UL AWM Style 20549

**Design**

- Extra-fine wire, tinned copper strands
- Core insulation: blue and brown
- Profiled outer sheath: TPE or PUR
- Colour: yellow (RAL 1023) or black (RAL 9005)

**Technical data**

- Peak operating voltage**  
300 V (not for power applications)
- Conductor resistance**  
1.5 mm<sup>2</sup>: max. 13.7 Ohm/km  
2.5 mm<sup>2</sup>: max. 8.21 Ohm/km
- Minimum bending radius**  
Fixed installation: 12 mm  
Flexing without fixing: 24 mm  
Flexing with fixing: 60 mm (15 x D)
- Test voltage**  
Core/core: 2000 V
- Temperature range**  
Fixed installation:  
-40°C to +80°C (TPE +105°C)  
Flexing without fixing:  
-30°C to +70°C (TPE +105°C)

Article number	Article designation	Outer sheath material	Outer sheath colour	Application	Number of cores and mm <sup>2</sup> per conductor	Copper index (kg/km)	Weight (kg/km)
<b>For highly flexible applications (power chains, moving machine parts)</b>							
2170357	UNITRONIC® BUS ASI FD P FRNC	PUR UL/CSA (AWM)	yellow	Data and power transmission	2 x 1,5	29.0	64
2170358	UNITRONIC® BUS ASI FD P FRNC	PUR UL/CSA (AWM)	black	Transmission of 30 V DC auxiliary power	2 x 1,5	29.0	64
2170317	UNITRONIC® BUS ASI LD FD P	PUR UL/CSA (AWM)	yellow	Data and power transmission	2 x 2,5	48.0	74
2170318	UNITRONIC® BUS ASI LD FD P	PUR UL/CSA (AWM)	black	Transmission of 30 V DC auxiliary power	2 x 2,5	48.0	74
2170830	UNITRONIC® BUS ASI FD (TPE) A	TPE UL/CSA (AWM)	yellow	Data and power transmission	2 x 1,5	29.0	64
2170831	UNITRONIC® BUS ASI FD (TPE) A	TPE UL/CSA (AWM)	black	Transmission of 30 V DC auxiliary power	2 x 1,5	29.0	64

Unless specified otherwise, the shown product values are nominal values. Detailed values (e.g. tolerances) are available upon request.  
 Copper price basis: EUR 150/100kg. Refer to catalogue appendix T17 for the definition and calculation of copper-related surcharges.  
 Please find our standard lengths at: [www.lappkabel.de/en/cable-standardlengths](http://www.lappkabel.de/en/cable-standardlengths)  
 Lapp Kabel is a member of the AS-International Association  
 Photographs are not to scale and do not represent detailed images of the respective products.

**Accessories**

- SKINTOP® DIX-M AUTOMATION refer to page 267
- UNIVERSAL STRIP stripping and cutting tool
- AS-I clip clamp / AS-I end sealing
- AS-I STRIP special stripping tool
- AS-I STRIP special
- SKINTOP® DIX ASI



## UNITRONIC® BUS PB

### Fixed installation

**Info**

- Lapp Kabel is a member of the PROFIBUS User Organisation (PNO)
- A for Advanced here: UL and CSA approvals

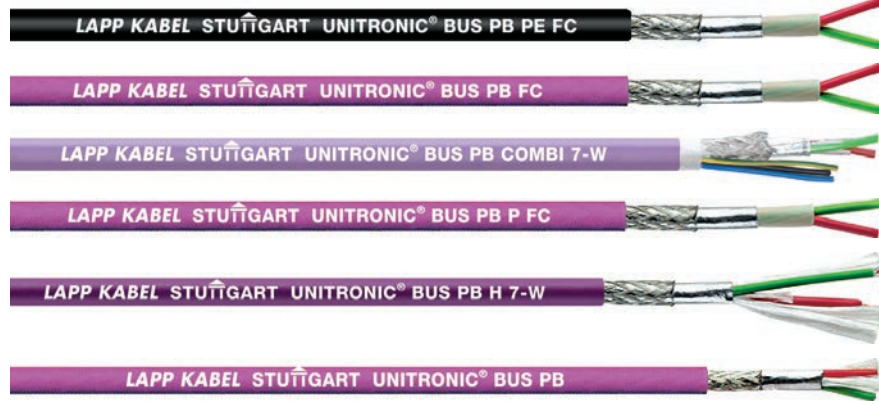

#### Application range

- For fixed installation
- Maximum electromagnetic screening
- Dry or damp rooms
- Item nos. 2170233, 2170333, 2170820, 2170824, 2170826 are all UV-resistant

#### Product features

- These bus cables can be used for PROFIBUS-DP as well as for PROFIBUS-FMS and FIP
- Based on the bit rates listed, in accordance with PNO specifications the following maximum cable lengths for a bus segment apply (cable type A, PROFIBUS-DP):  
 93.75 kbit/s = 1200 m  
 187.5 kbit/s = 1000 m  
 500 kbit/s = 400 m  
 1.5 Mbit/s = 200 m  
 12.0 Mbit/s = 100 m

#### Norm references / Approvals

- In accordance with DIN 19245 and EN 50170, e.g. for SIEMENS SIMATIC NET, also suitable for FIP (Factory Instrumentation Protocol)
- See below for UL approval type

#### Design

- FC: "Fast Connect" cable design
- P: Polyurethane
- H: Halogen-free
- PE: polyethylene, black Outer sheath, e.g. for the food and beverage industry
- 7-W: 7-wire, e.g. for applications where vibrations occur
- COMBI: Data transmission and power supply in one cable

#### Technical data

- Mutual capacitance** (800 Hz): max. 30 nF/km
- Peak operating voltage** (not for power applications) 250 V
- Conductor resistance** (loop): max. 133 ohm/km
- Minimum bending radius** Fixed installation: see data sheet
- Test voltage** Core/core: 1500 V rms
- Characteristic impedance** 150 ± 15 Ohm

Article number	Article designation	Number of pairs and conductor diameter (mm)	Outer diameter (mm)	Copper index (kg/km)	Weight (kg/km)
<b>For fixed installation - conventional cable assembly</b>					
2170220	UNITRONIC® BUS PB	1 x 2 x 0.64	8.0	30.1	74
2170233	UNITRONIC® PB PE	1 x 2 x 0.64	8.0	30.1	57
2170226	UNITRONIC® BUS PB H 7-W	1 x 2 x 0.64	8.0	30.1	55
2170225	UNITRONIC® BUS PB COMBI 7-W	1 x 2 x 0,64 Ø + 3 x 1,0 mm <sup>2</sup>	9.8	59.0	92
<b>For fixed installation - UL/CSA CMX approval</b>					
2170219	UNITRONIC® BUS PB A	1 x 2 x 0.64	8.0	30.1	57
<b>For fixed installation - UL/CSA CMG approval</b>					
2170824	UNITRONIC® BUS PB 7-W A	1 x 2 x 0.64	8.0	30.1	55
<b>For fixed installation - "Fast Connect" cable assembly</b>					
2170333	UNITRONIC® BUS PB PE FC	1 x 2 x 0.64	8.0	26.0	67
<b>For fixed installation - UL/CSA CMX approval</b>					
2170330	UNITRONIC® BUS PB P FC	1 x 2 x 0.64	8.0	26.0	71
<b>For fixed installation - "Fast Connect" cable assembly - UL/CSA CMG approval</b>					
2170820	UNITRONIC® BUS PB FC	1 x 2 x 0.64	8.0	26.0	84
2170826	UNITRONIC® BUS PB 7-W FC	1 x 2 x 0.64	8.0	26.0	67
2170326	UNITRONIC® BUS PB-H FC	1 x 2 x 0.64	8.0	26.0	72

Unless specified otherwise, the shown product values are nominal values. Detailed values (e.g. tolerances) are available upon request. Copper price basis: EUR 150/100kg. Refer to catalogue appendix T17 for the definition and calculation of copper-related surcharges.

Please find our standard lengths at: [www.lappkabel.de/en/cable-standardlengths](http://www.lappkabel.de/en/cable-standardlengths)

Packaging size: coil ≤ 30 kg or ≤ 250 m, otherwise drum

Please specify the preferred type of packaging (e.g. 1 x 500 m drum or 5 x 100 m coils).

SIMATIC NET® is a registered trademark of Siemens AG

Lapp Kabel is a member of the PROFIBUS user organisation (PNO)

Photographs are not to scale and do not represent detailed images of the respective products.

#### Similar products

- UNITRONIC® BUS PB ROBUST refer to page 53
- UNITRONIC® BUS PB 105 refer to page 54

#### Accessories

- EPIC® Data Connectors refer to page 69
- FC STRIP stripping tool
- SENSOR STRIP stripping tool



New

## UNITRONIC® BUS PB TRAY

Fixed installation



Info

- PLTC-ER (power limited tray cable exposed run) for unprotected use on cable trays

### Benefits

- Cables can be used for PROFIBUS-DP as well as PROFIBUS-FMS and FIP
- PLTC-ER approval for open wiring between cable tray and industrial machines/plants acc. to NEC 725.154 (D)
- No additional protection of the cable needed

### Application range

- For fixed installation or applications with occasional movements
- PROFIBUS DP (in accordance with DIN 19245 and EN 50170, e.g. for SIEMENS SIMATIC® NET, also suitable for FIP - Factory Instrumentation Protocol).

### Product features

- UV-resistant UL SUN RES
- Oil-resistant according to UL OIL RES I
- Flame retardant acc. UL 1685 - FT4 (vertical tray)
- Based on the bit rates listed, in accordance with PNO specifications the following maximum cable lengths for a bus segment apply (cable type A, PROFIBUS-DP):  
 93.75 kbit/s = 1200 m  
 187.5 kbit/s = 1000 m  
 500 kbit/s = 400 m  
 1.5 Mbit/s = 200 m  
 12.0 Mbit/s = 100 m

### Norm references / Approvals

- C(UL)us Typ CMG (75°C) nach UL 444 / CSA 22.2
- UL Type PLTC-ER acc. to UL 13

### Design

- Bare copper wire, 0,64 mm diameter
- Core colours: red, green
- Overall screening with copper braid and plastic-laminated aluminium foil
- PVC inner sheath and outer sheath
- Colour: violet (RAL 4001)

### Technical data

- Mutual capacitance**  
(1 kHz): max. 30 nF/km
- Peak operating voltage**  
(not for power applications) 250 V
- Impedance**  
150 +/- 15 Ohm
- Conductor resistance**  
(loop): max. 110 ohm/km
- Minimum bending radius**  
Fixed installation: 8 x outer diameter
- Test voltage**  
Core/core: 2000 V
- Characteristic impedance**  
150 ± 15 Ohm
- Temperature range**  
Flexing: -10°C to +70°C  
Fixed installation: -40°C to +80°C

Article number	Article designation	Number of pairs and conductor diameter (mm)	Outer diameter (mm)	Copper index (kg/km)	Weight (kg/km)
<b>UNITRONIC® BUS PB TRAY</b>					
2170856	UNITRONIC® BUS PB TRAY	1x2x0,64	8.4	26.0	82

Unless specified otherwise, the shown product values are nominal values. Detailed values (e.g. tolerances) are available upon request.  
 Copper price basis: EUR 150/100kg. Refer to catalogue appendix T17 for the definition and calculation of copper-related surcharges.  
 Please find our standard lengths at: [www.lappkabel.de/en/cable-standardlengths](http://www.lappkabel.de/en/cable-standardlengths)  
 Packaging size: coil ≤ 30 kg or ≤ 250 m, otherwise drum  
 Please specify the preferred type of packaging (e.g. 1 x 500 m drum or 5 x 100 m coils).  
 SIMATIC® is a registered trademark of SIEMENS AG. FIP is a registered trademark of World FIP  
 Lapp Kabel is a member of the PROFIBUS user organisation (PNO)  
 Photographs are not to scale and do not represent detailed images of the respective products.

### Accessories

- EPIC® Data Connectors refer to page 69





## UNITRONIC® BUS PB ROBUST

Fixed installation

LAPP KABEL STUTTGART UNITRONIC® BUS PB ROBUST



### Benefits

- Robust PROFIBUS cable for use under harsh environmental conditions

### Application range

- For use for PROFIBUS-DP or FIP in harsh industrial environments
- Fixed installation

### Product features

- Significantly extended use and application areas, water and chemical resistance for use in industrial conditions.
- High resistance to tensides, soaps etc.
- UV-resistant
- Flame-retardant according IEC 60332-1-2
- Based on the bit rates listed, in accordance with PNO specifications the following maximum cable lengths for a bus segment apply (cable type A, PROFIBUS-DP):  
 93.75 kbit/s = 1200 m  
 187.5 kbit/s = 1000 m  
 500 kbit/s = 400 m  
 1.5 Mbit/s = 200 m  
 12.0 Mbit/s = 100 m

### Design

- Solid and bare copper conductor
- Foam Skin - core isolation (O2YS)
- Overall screening with copper braid and plastic-laminated aluminium foil
- Tin-plated copper wire braiding
- With conventional cable design, but with an outer sheath made of special TPE

### Technical data

- Mutual capacitance**  
(1 kHz): approx. 28.5 nF/km
- Peak operating voltage**  
(not for power applications) 250 V
- Minimum bending radius**  
Fixed installation: 75 mm
- Test voltage**  
Core/core: 1500 V rms  
Core/screen: 1500 V
- Characteristic impedance**  
(3 - 20 MHz): 150 ± 15 Ohm
- Temperature range**  
-40°C to +80°C

Article number	Article designation	Number of pairs and conductor diameter (mm)	Outer diameter (mm)	Copper index (kg/km)	Weight (kg/km)
<b>for fixed installation</b>					
2170620	UNITRONIC® BUS PB ROBUST	1 x 2 x 0.64	8.0	26.0	55

Unless specified otherwise, the shown product values are nominal values. Detailed values (e.g. tolerances) are available upon request.  
 Copper price basis: EUR 150/100kg. Refer to catalogue appendix T 17 for the definition and calculation of copper-related surcharges.  
 Please find our standard lengths at: [www.lappkabel.de/en/cable-standardlengths](http://www.lappkabel.de/en/cable-standardlengths)  
 Packaging size: coil ≤ 30 kg or ≤ 250 m, otherwise drum  
 Please specify the preferred type of packaging (e.g. 1 x 500 m drum or 5 x 100 m coils).  
 SIMATIC® is a registered trademark of SIEMENS AG. FIP is a registered trademark of World FIP  
 Lapp Kabel is a member of the PROFIBUS user organisation (PNO)  
 Photographs are not to scale and do not represent detailed images of the respective products.

### Accessories

- EPIC® Data Connectors refer to page 69



## UNITRONIC® BUS PB 105

### Fixed installation

LAPP KABEL STUÏGART UNITRONIC® BUS PB 105

#### ■ Benefits

- A standard PROFIBUS cable can only be used up to a max. temperature of 80°C
- This enables an extended area of application

#### ■ Application range

- Cable has been designed for use in factory halls where temperatures up to max. 105°C may occur.

#### ■ Product features

- Flame-retardant according IEC 60332-1-2
- Oil-resistant

#### ■ Design

- Stranded conductor, 7-wire, bare
- Core insulation: PP
- Overall screening with copper braid and plastic-laminated aluminium foil
- Tin-plated copper wire braiding
- PVC outer sheath for use up to 105°C

#### ■ Suitable connectors

- EPIC® Data Connectors Page 69

#### ■ Technical data

- Mutual capacitance**  
Approx. 28.5 nF/km
- Peak operating voltage**  
max. 100 V (not for power applications)
- Minimum bending radius**  
Fixed installation: 45 mm once  
Flexing: 65 mm
- Test voltage**  
Core/core: 1500 V rms  
Core/screen: 1500 V
- Characteristic impedance**  
(3 - 20 MHz): 150 ± 15 Ohm
- Temperature range**  
-30°C to +105°C

Article number	Article designation	Number of pairs and conductor diameter (mm)	Outer diameter (mm)	Copper index (kg/km)	Weight (kg/km)
<b>UNITRONIC® BUS PB 105</b>					
2170630	UNITRONIC® BUS PB 105	1 x 2 x 0.64	8.0	30.1	72

Unless specified otherwise, the shown product values are nominal values. Detailed values (e.g. tolerances) are available upon request.  
Copper price basis: EUR 150/100kg. Refer to catalogue appendix T17 for the definition and calculation of copper-related surcharges.  
Please find our standard lengths at: [www.lappkabel.de/en/cable-standardlengths](http://www.lappkabel.de/en/cable-standardlengths)  
Lapp Kabel is a member of the PROFIBUS user organisation (PNO)  
Photographs are not to scale and do not represent detailed images of the respective products.

#### ■ Accessories

- Multipurpose shears A and B

New

## UNITRONIC® BUS PB 105 plus

LAPP KABEL STUÏGART UNITRONIC® BUS PB 105 plus

#### ■ Benefits

- No need for additional cable protection against high temperatures
- High temperature resistance

#### ■ Application range

- For installation in hollow shaft between gear units and pitch system
- Suitable for fixed installation and occasionally flexible use in high temperature areas

#### ■ Product features

- Permanent load up to +105°C, temporary load +120°C

#### ■ Norm references / Approvals

- In accordance with DIN 19245 and EN 50170, e.g. for SIEMENS SIMATIC NET, also suitable for FIP (Factory Instrumentation Protocol)

#### ■ Design

- Stranded conductor, 7-wire, bare
- Core insulation: polypropylene (PP)
- Overall screening with copper braid and plastic-laminated aluminium foil
- Outer sheath: TPE-based



#### Info

- Cables for bus systems PROFIBUS-DP/FMS/FIP
- Lapp Kabel is a member of the PROFIBUS User Organisation (PNO)

#### ■ Technical data

- Mutual capacitance**  
(800 Hz): max. 30 nF/km
- Peak operating voltage**  
(not for power applications) 250 V
- Minimum bending radius**  
Fixed installation: 45 mm once  
Flexing: 65 mm
- Test voltage**  
Core/core: 1500 V rms  
Core/screen: 1500 V eff.
- Characteristic impedance**  
(3 - 20 MHz): 150 ± 15 Ohm
- Temperature range**  
Fixed installation: -40°C to +105°C  
Short-term: up to +120 °C

Article number	Article designation	Number of pairs and conductor diameter (mm)	Outer diameter (mm)	Copper index (kg/km)
<b>UNITRONIC® BUS PB 105 plus</b>				
2170635	UNITRONIC® BUS PB 105 plus	1x2x0,64	8.0	30.1

Photographs are not to scale and do not represent detailed images of the respective products.



**New**

## UNITRONIC® BUS PB HEAT 180

LAPP KABEL STUÏTGART UNITRONIC® BUS PB HEAT 180

### Benefits

- No need for additional cable protection against high temperatures
- High temperature resistance

### Application range

- Fixed installation
- For use in high temperature areas with up to 180 °C

### Product features

- High oil-resistance

### Design

- Solid and bare copper conductor
- Wire insulation Fluorethylen
- Overall screening with copper braid and plastic-laminated aluminium foil
- Screening: wrapped with braided tinned-copper wires
- Outer Sheath: Perfluorethylenpropylen, FEP, violet

### Suitable connectors

- EPIC® Data Connectors Page 69

### Technical data

- Mutual capacitance**  
approx. 28 nF / km
- Peak operating voltage**  
(not for power applications) 250 V
- Minimum bending radius**  
Repeated: 7 x Outer Diameter  
Single: 5 x Outer Diameter
- Test voltage**  
3600 V DC (3 sec.)
- Characteristic impedance**  
(3 - 20 MHz): 150 ± 15 Ohm
- Temperature range**  
-50 to +180 °C

Article number	Article designation	Number of pairs and conductor diameter (mm)	Copper index (kg/km)	Weight (kg/km)
<b>UNITRONIC® BUS PB HEAT 180</b>				
3031981	UNITRONIC® BUS PB HEAT 180 1X(2X0,64)	1 x 2 x 0,64	21.7	0.064

Unless specified otherwise, the shown product values are nominal values. Detailed values (e.g. tolerances) are available upon request.

Please find our standard lengths at: [www.lappkabel.de/en/cable-standardlengths](http://www.lappkabel.de/en/cable-standardlengths)

Packaging size: coil ≤ 30 kg or ≤ 250 m, otherwise drum

SIMATIC® is a registered trademark of SIEMENS AG. FIP is a registered trademark of World FIP

Lapp Kabel is a member of the PROFIBUS user organisation (PNO)

Photographs are not to scale and do not represent detailed images of the respective products.



## UNITRONIC® BUS PB ARM

Fixed installation

LAPP KABEL STUÏTGART UNITRONIC® BUS PB ARM

### Benefits

- EMC-optimised design

### Application range

- For use for PROFIBUS-DP or FIP in harsh industrial environments
- PROFIBUS DP (in accordance with DIN 19245 and EN 50170, e.g. for SIEMENS SIMATIC® NET, also suitable for FIP - Factory Instrumentation Protocol).

### Product features

- Flame-retardant according IEC 60332-1-2
- UV-resistant

### Design

- Solid and bare copper conductor
- Foam Skin - core isolation (O2YS)
- Overall screening with copper braid and plastic-laminated aluminium foil
- Overlapping plastic tape
- Copper tape, welded longitudinally
- Outer sheath: PVC

### Technical data

- Mutual capacitance**  
(800 Hz): max. 30 nF/km
- Peak operating voltage**  
(not for power applications) 100 V
- Minimum bending radius**  
Fixed installation: 7.5 x outer diameter  
Fixed installation: 3.5 x cable diameter once
- Test voltage**  
3600 V DC (3 sec.)
- Characteristic impedance**  
150 ± 15 Ohm
- Temperature range**  
-40 °C to +70 °C

Article number	Article designation	Number of pairs and conductor diameter (mm)	Outer diameter (mm)	Copper index (kg/km)	Weight (kg/km)
<b>UNITRONIC® BUS PB ARM</b>					
2170247	UNITRONIC® BUS PB ARM	1 x 2 x 0.65	11.1	86.9	131

Unless specified otherwise, the shown product values are nominal values. Detailed values (e.g. tolerances) are available upon request.

Copper price basis: EUR 150/100kg. Refer to catalogue appendix T17 for the definition and calculation of copper-related surcharges.

Please find our standard lengths at: [www.lappkabel.de/en/cable-standardlengths](http://www.lappkabel.de/en/cable-standardlengths)

Packaging size: coil ≤ 30 kg or ≤ 250 m, otherwise drum

Please specify the preferred type of packaging (e.g. 1 x 500 m drum or 5 x 100 m coils).

SIMATIC® is a registered trademark of SIEMENS AG. FIP is a registered trademark of World FIP

Lapp Kabel is a member of the PROFIBUS user organisation (PNO)

Photographs are not to scale and do not represent detailed images of the respective products.



## UNITRONIC® BUS PB FRNC FC

### Fixed installation

LAPP KABEL STUÏGART UNITRONIC® BUS PB FRNC FC



**Info**

- FRNC = Flame Retardant Non Corrosive
- Reduction of flame-propagation and density and toxicity of smoke gases in the event of fire
- Minimisation of damage to buildings and production facilities
- Safety for staff and in areas with high density of people

#### ■ Benefits

- Halogen-free and highly flame-retardant
- Cables can be used for PROFIBUS-DP as well as PROFIBUS-FMS and FIP
- For use where the combination of a halogen-free outer sheath with properties similar to PUR and enhanced flame-retardance is required
- Fast Connect (FC) cable design

#### ■ Application range

- This cable provides special advantages for use in sensitive areas where fire propagation must be avoided and the presence of toxic fumes would cause personal injury and damage to equipment.

#### ■ Product features

- The cable is UL/CSA-approved (CMG)
- Halogen-free
- High flame retardancy in accordance with IEC 60332-3 and FT4
- Oil-resistant
- Based on the bit rates listed, in accordance with PNO specifications the following maximum cable lengths for a bus segment apply (cable type A, PROFIBUS-DP):  
 93.75 kbit/s = 1200 m  
 187.5 kbit/s = 1000 m  
 500 kbit/s = 400 m  
 1.5 Mbit/s = 200 m  
 12.0 Mbit/s = 100 m

#### ■ Design

- Solid, bare, single-wire copper conductor
- PE core insulation
- Inner sheath, screening foil and braiding
- Thermoplastic outer sheath
- Colour: violet (RAL 4001)

#### ■ Technical data



**Approvals**  
UL/CSA (CMG)



**Mutual capacitance**  
Approx. 28.5 nF/km



**Peak operating voltage**  
(not for power applications) 250 V



**Minimum bending radius**  
80mm



**Test voltage**  
Core/core: 1500 V rms  
Core/screen: 1500 V



**Characteristic impedance**  
(3 - 20 MHz): 150 ± 15 Ohm



**Temperature range**  
-30°C to +80°C

Article number	Article designation	Number of pairs and conductor diameter (mm)	Outer diameter (mm)	Copper index (kg/km)	Weight (kg/km)
2170853	UNITRONIC® BUS PB FRNC FC	1 x 2 x 0.64	8.0	30.1	75

Unless specified otherwise, the shown product values are nominal values. Detailed values (e.g. tolerances) are available upon request.  
 Copper price basis: EUR 150/100kg. Refer to catalogue appendix T17 for the definition and calculation of copper-related surcharges.  
 Please find our standard lengths at: [www.lappkabel.de/en/cable-standardlengths](http://www.lappkabel.de/en/cable-standardlengths)  
 Packaging size: coil ≤ 30 kg or ≤ 250 m, otherwise drum  
 Please specify the preferred type of packaging (e.g. 1 x 500 m drum or 5 x 100 m coils).  
 Lapp Kabel is a member of the PROFIBUS user organisation (PNO)  
 Photographs are not to scale and do not represent detailed images of the respective products.

#### ■ Accessories

- EPIC® Data Connectors refer to page 69
- FC STRIP stripping tool



## UNITRONIC® BUS PB Yv

Suitable for outdoor use and direct burial, UV-resistant



### Benefits

- Rugged, UV-resistant and weatherproof
- Cables can be used for PROFIBUS-DP as well as PROFIBUS-FMS and FIP

### Application range

- PROFIBUS DP (in accordance with DIN 19245 and EN 50170, e.g. for SIEMENS SIMATIC® NET, also suitable for FIP - Factory Instrumentation Protocol).

### Product features

- Reinforced outer sheath made of PVC

### Design

- Solid and bare copper conductor
- Foam Skin - core isolation (O2YS)
- Overall screening with copper braid and plastic-laminated aluminium foil
- Tin-plated copper wire braiding
- Outer sheath: reinforced PVC, black

### Technical data

- Mutual capacitance**  
(800 Hz): max. 30 nF/km
- Peak operating voltage**  
(not for power applications) 250 V
- Minimum bending radius**  
Fixed installation: 75 mm once  
Fixed installation: 150 mm
- Test voltage**  
Core/core: 1500 V rms  
Core/screen: 1500 V
- Characteristic impedance**  
150 ± 15 Ohm
- Temperature range**  
Flexing: -5°C to +50°C  
Fixed installation: -40°C to +80°C

Article number	Article designation	Number of pairs and conductor diameter (mm)	Outer diameter (mm)	Copper index (kg/km)	Weight (kg/km)
<b>Suitable for outdoor use and direct burial</b>					
2170223	UNITRONIC® BUS PB Yv	1 x 2 x 0.64	9.4	30.1	106

Unless specified otherwise, the shown product values are nominal values. Detailed values (e.g. tolerances) are available upon request.

Copper price basis: EUR 150/100kg. Refer to catalogue appendix T17 for the definition and calculation of copper-related surcharges.

Please find our standard lengths at: [www.lappkabel.de/en/cable-standardlengths](http://www.lappkabel.de/en/cable-standardlengths)

Packaging size: coil ≤ 30 kg or ≤ 250 m, otherwise drum

Please specify the preferred type of packaging (e.g. 1 x 500 m drum or 5 x 100 m coils).

SIMATIC® is a registered trademark of SIEMENS AG. FIP is a registered trademark of World FIP

Lapp Kabel is a member of the PROFIBUS user organisation (PNO)

Photographs are not to scale and do not represent detailed images of the respective products.





## UNITRONIC® BUS PB YY

Suitable for outdoor use and direct burial, UV-resistant



### Benefits

- Rugged, UV-resistant and weatherproof
- Cables can be used for PROFIBUS-DP as well as PROFIBUS-FMS and FIP

### Application range

- PROFIBUS DP (in accordance with DIN 19245 and EN 50170, e.g. for SIEMENS SIMATIC® NET, also suitable for FIP - Factory Instrumentation Protocol).

### Product features

- Dual PVC outer sheath

### Design

- Solid and bare copper conductor
- PE core insulation
- Overall screening with copper braid and plastic-laminated aluminium foil
- Tin-plated copper wire braiding
- PVC outer sheath, violet, OD 7.5 mm  
PVC outer sheath, black, OD 9.5 mm

### Technical data

- Mutual capacitance**  
(800 Hz): max. 30 nF/km
- Peak operating voltage**  
(not for power applications) 250 V
- Minimum bending radius**  
Fixed installation: 75 mm once  
Fixed installation: 150 mm
- Test voltage**  
Core/core: 1500 V rms  
Core/screen: 1500 V
- Characteristic impedance**  
150 ± 15 Ohm
- Temperature range**  
Flexing: -5°C to +50°C  
Fixed installation: -40°C to +80°C

Article number	Article designation	Number of pairs and conductor diameter (mm)	Outer diameter (mm)	Copper index (kg/km)	Weight (kg/km)
<b>Suitable for outdoor use and direct burial</b>					
2170236	UNITRONIC® BUS PB YY	1 x 2 x 0.64	9.5	30.1	87

Unless specified otherwise, the shown product values are nominal values. Detailed values (e.g. tolerances) are available upon request.  
 Copper price basis: EUR 150/100kg. Refer to catalogue appendix T17 for the definition and calculation of copper-related surcharges.  
 Please find our standard lengths at: [www.lappkabel.de/en/cable-standardlengths](http://www.lappkabel.de/en/cable-standardlengths)  
 Packaging size: coil ≤ 30 kg or ≤ 250 m, otherwise drum  
 Please specify the preferred type of packaging (e.g. 1 x 500 m drum or 5 x 100 m coils).  
 SIMATIC® is a registered trademark of SIEMENS AG. FIP is a registered trademark of World FIP  
 Lapp Kabel is a member of the PROFIBUS user organisation (PNO)  
 Photographs are not to scale and do not represent detailed images of the respective products.

### Accessories

- EPIC® Data Connectors refer to page 69
- Multipurpose shears A and B



## UNITRONIC® BUS PB BURIAL FC

Suitable for outdoor use and direct burial, UV-resistant



### Benefits

- Fast Connect (FC) cable design
- Rugged, UV-resistant and weatherproof
- Cables can be used for PROFIBUS-DP as well as PROFIBUS-FMS and FIP

### Application range

- PROFIBUS DP (in accordance with DIN 19245 and EN 50170, e.g. for SIEMENS SIMATIC® NET, also suitable for FIP - Factory Instrumentation Protocol).

### Product features

- Second PE outer sheath

### Design

- Solid and bare copper conductor
- Foam Skin - core isolation (O2YS)
- Overall screening with copper braid and plastic-laminated aluminium foil
- Tin-plated copper wire braiding
- PVC outer sheath, violet, OD 8 mm
- PE outer sheath, black, OD 10.8 mm

### Technical data

- Mutual capacitance**  
(800 Hz): max. 30 nF/km
- Peak operating voltage**  
(not for power applications) 100 V
- Minimum bending radius**  
Fixed installation:  
3.5 x cable diameter once  
Fixed installation: 7.5 x cable diameter
- Test voltage**  
3600 V DC (3 sec.)
- Characteristic impedance**  
150 ± 15 Ohm
- Temperature range**  
-40 °C to +60 °C

Article number	Article designation	Number of pairs and conductor diameter (mm)	Outer diameter (mm)	Copper index (kg/km)	Weight (kg/km)
<b>Suitable for outdoor use and direct burial</b>					
2170323	UNITRONIC® BUS PB BURIAL FC	1 x 2 x 0.64	10.8	26.0	115

Unless specified otherwise, the shown product values are nominal values. Detailed values (e.g. tolerances) are available upon request.  
 Copper price basis: EUR 150/100kg. Refer to catalogue appendix T17 for the definition and calculation of copper-related surcharges.  
 Please find our standard lengths at: [www.lappkabel.de/en/cable-standardlengths](http://www.lappkabel.de/en/cable-standardlengths)  
 Packaging size: coil ≤ 30 kg or ≤ 250 m, otherwise drum  
 Please specify the preferred type of packaging (e.g. 1 x 500 m drum or 5 x 100 m coils).  
 SIMATIC® is a registered trademark of SIEMENS AG. FIP is a registered trademark of World FIP  
 Lapp Kabel is a member of the PROFIBUS user organisation (PNO)  
 Photographs are not to scale and do not represent detailed images of the respective products.

### Accessories

- EPIC® Data Connectors refer to page 69
- FC STRIP stripping tool



**New**

**UNITRONIC® BUS PB Y 7-W FC BK**

Suitable for outdoor use, UV-resistant

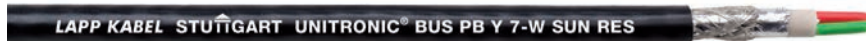

**Benefits**

- UV and weather-resistant in black
- 7-W: 7-wire, e.g. for applications where vibrations occur
- Fast Connect (FC) cable design
- Cables can be used for PROFIBUS-DP as well as PROFIBUS-FMS and FIP

**Application range**

- PROFIBUS DP (in accordance with DIN 19245 and EN 50170, e.g. for SIEMENS SIMATIC® NET, also suitable for FIP - Factory Instrumentation Protocol).

**Product features**

- PVC compound TM2 acc. to EN 50363-4-1
- Resistant to acids, alkalis and certain oils at room temperature

**Design**

- Stranded conductor, 7-wire, bare
- Foam Skin - core isolation (O2YS)
- Overall screening with copper braid and plastic-laminated aluminium foil
- Tin-plated copper wire braiding
- PVC outer sheath, black

**Suitable tools**

- FC STRIP stripping tool

**Technical data**

- Mutual capacitance**  
(800 Hz): max. 30 nF/km
- Peak operating voltage**  
(not for power applications) 250 V
- Minimum bending radius**  
Fixed installation: 8 x outer diameter  
Flexing: 15 x outer diameter
- Test voltage**  
Core/core: 1500 V rms  
Core/screen: 1500 V
- Characteristic impedance**  
150 ± 15 Ohm
- Temperature range**  
Flexing: -10°C to +70°C  
Fixed installation: -40°C to +80°C

Article number	Article designation	Number of pairs and conductor diameter (mm)	Outer diameter (mm)	Copper index (kg/km)	Weight (kg/km)
<b>UNITRONIC® BUS PB Y 7-W FC BK</b>					
2170310	UNITRONIC® BUS PB Y 7-W FC BK	1 x 2 x 0.64	7.8	30.1	80

Unless specified otherwise, the shown product values are nominal values. Detailed values (e.g. tolerances) are available upon request.  
 Copper price basis: EUR 150/100kg. Refer to catalogue appendix T17 for the definition and calculation of copper-related surcharges.  
 Please find our standard lengths at: [www.lappkabel.de/en/cable-standardlengths](http://www.lappkabel.de/en/cable-standardlengths)  
 Packaging size: coil ≤ 30 kg or ≤ 250 m, otherwise drum  
 Please specify the preferred type of packaging (e.g. 1 x 500 m drum or 5 x 100 m coils).  
 SIMATIC® is a registered trademark of SIEMENS AG. FIP is a registered trademark of World FIP  
 Lapp Kabel is a member of the PROFIBUS user organisation (PNO)  
 Photographs are not to scale and do not represent detailed images of the respective products.

**Accessories**

- EPIC® Data Connectors refer to page 69
- FC STRIP stripping tool

ÖLFLEX®  
 UNITRONIC®  
 ETHERLINE®  
 HITRONIC®  
 EPIC®  
 SKINTOP®  
 FLEXIMARK®  
 APPENDIX



## UNITRONIC® BUS PB FD P

Highly flexible application

LAPP KABEL STUÏGART UNITRONIC® BUS PB FD P



### Benefits

- For use where the combination of a halogen-free outer sheath with properties similar to PUR and enhanced flame-retardance is required
- For highly flexible applications (power chains, moving machine parts)
- Cables can be used for PROFIBUS-DP as well as PROFIBUS-FMS and FIP

### Application range

- PROFIBUS DP (in accordance with DIN 19245 and EN 50170, e.g. for SIEMENS SIMATIC® NET, also suitable for FIP - Factory Instrumentation Protocol).
- Suitable for torsional applications which are typical for the loop in wind turbine generators (WTG)

### Product features

- Halogen-free
- Flame-retardant according IEC 60332-1-2
- Oil-resistant
- Based on the bit rates listed, in accordance with PNO specifications the following maximum cable lengths for a bus segment apply (cable type A, PROFIBUS-DP):  
 93.75 kbit/s = 1200 m  
 187.5 kbit/s = 1000 m  
 500 kbit/s = 400 m  
 1.5 Mbit/s = 200 m  
 12.0 Mbit/s = 100 m

### Design

- Foam Skin - core isolation (O2YS)
- Overall screening with copper braid and plastic-laminated aluminium foil
- Tin-plated copper wire braiding
- Outer sheath: PUR compound

### Technical data

- Mutual capacitance**  
(800 Hz): max. 30 nF/km
- Peak operating voltage**  
(not for power applications) 250 V
- Torsion movement in WTG**  
TW-0 & TW-2, refer to Appendix T0
- Minimum bending radius**  
65 mm
- Test voltage**  
Core/core: 1500 V rms
- Characteristic impedance**  
150 ± 15 Ohm
- Temperature range**  
Flexing: -30°C to +70°C  
Fixed installation: -40°C to +80°C

Article number	Article designation	Number of pairs and conductor diameter (mm)	Outer diameter (mm)	Copper index (kg/km)	Weight (kg/km)
<b>For highly flexible applications (e.g. power chains) - conventional cable assembly</b>					
2170222	UNITRONIC® BUS PB FD P 1x2x0,64	1 x 2 x 0.64	8.0	30.1	64

Unless specified otherwise, the shown product values are nominal values. Detailed values (e.g. tolerances) are available upon request.  
 Copper price basis: EUR 150/100kg. Refer to catalogue appendix T17 for the definition and calculation of copper-related surcharges.  
 Please find our standard lengths at: [www.lappkabel.de/en/cable-standardlengths](http://www.lappkabel.de/en/cable-standardlengths)  
 Packaging size: coil ≤ 30 kg or ≤ 250 m, otherwise drum  
 Please specify the preferred type of packaging (e.g. 1 x 500 m drum or 5 x 100 m coils).  
 SIMATIC® is a registered trademark of SIEMENS AG. FIP is a registered trademark of World FIP  
 Lapp Kabel is a member of the PROFIBUS user organisation (PNO)  
 Photographs are not to scale and do not represent detailed images of the respective products.

### Accessories

- EPIC® Data Connectors refer to page 69





## UNITRONIC® BUS PB FD P A

Highly flexible application

LAPP KABEL STUTTGART UNITRONIC® BUS PB FD P A



### Info

- A for Advanced here: UL and CSA approvals

### Benefits

- For use where the combination of a halogen-free outer sheath with properties similar to PUR and enhanced flame-retardance is required
- Cables can be used for PROFIBUS-DP as well as PROFIBUS-FMS and FIP
- For highly flexible applications (power chains, moving machine parts)

### Application range

- PROFIBUS DP (in accordance with DIN 19245 and EN 50170, e.g. for SIEMENS SIMATIC® NET, also suitable for FIP - Factory Instrumentation Protocol).
- Suitable for torsional applications which are typical for the loop in wind turbine generators (WTG)

### Product features

- Halogen-free
- Flame-retardant according IEC 60332-1-2
- Oil-resistant
- Based on the bit rates listed, in accordance with PNO specifications the following maximum cable lengths for a bus segment apply  
(cable type A, PROFIBUS-DP):  
93.75 kbit/s = 1200 m  
187.5 kbit/s = 1000 m  
500 kbit/s = 400 m  
1.5 Mbit/s = 200 m  
12.0 Mbit/s = 100 m

### Norm references / Approvals

- Approval: UL/CSA type CMX in accordance with UL 444 and CSA C22.2 no. 214

### Design

- Stranded bare copper wire
- Foam Skin - core isolation (O2YS)
- Overall screening with copper braid and plastic-laminated aluminium foil
- Screening: wrapped with braided tinned-copper wires
- Outer sheath: PUR compound

### Technical data

- Mutual capacitance**  
(800 Hz): max. 30 nF/km
- Peak operating voltage**  
(not for power applications) 250 V
- Torsion movement in WTG**  
TW-0 & TW-2, refer to Appendix T0
- Minimum bending radius**  
65 mm
- Test voltage**  
Core/core: 1500 V rms
- Characteristic impedance**  
150 ± 15 Ohm
- Temperature range**  
Flexing: -30°C to +70°C  
Fixed installation: -40°C to +80°C

Article number	Article designation	Number of pairs and conductor diameter (mm)	Outer diameter (mm)	Copper index (kg/km)	Weight (kg/km)
<b>Highly flexible application</b>					
2170822	UNITRONIC® BUS PB FD P A	1 x 2 x 0.64	8.0	30.1	58

Unless specified otherwise, the shown product values are nominal values. Detailed values (e.g. tolerances) are available upon request.  
Copper price basis: EUR 150/100kg. Refer to catalogue appendix T 17 for the definition and calculation of copper-related surcharges.  
Please find our standard lengths at: [www.lappkabel.de/en/cable-standardlengths](http://www.lappkabel.de/en/cable-standardlengths)  
Packaging size: coil ≤ 30 kg or ≤ 250 m, otherwise drum  
Please specify the preferred type of packaging (e.g. 1 x 500 m drum or 5 x 100 m coils).  
SIMATIC® is a registered trademark of SIEMENS AG. FIP is a registered trademark of World FIP  
Lapp Kabel is a member of the PROFIBUS user organisation (PNO)  
Photographs are not to scale and do not represent detailed images of the respective products.

### Accessories

- EPIC® Data Connectors refer to page 69



## UNITRONIC® BUS PB FD P FC

Highly flexible application

LAPP KABEL STUTTGART UNITRONIC® BUS PB FD P FC

### Benefits

- Fast Connect (FC) cable design
- Cables can be used for PROFIBUS-DP as well as PROFIBUS-FMS and FIP
- For highly flexible applications (power chains, moving machine parts)

### Application range

- PROFIBUS DP (in accordance with DIN 19245 and EN 50170, e.g. for SIEMENS SIMATIC® NET, also suitable for FIP - Factory Instrumentation Protocol).

### Product features

- Flame-retardant according IEC 60332-1-2
- Oil-resistant
- Based on the bit rates listed, in accordance with PNO specifications the following maximum cable lengths for a bus segment apply (cable type A, PROFIBUS-DP):  
 93.75 kbit/s = 1200 m  
 187.5 kbit/s = 1000 m  
 500 kbit/s = 400 m  
 1.5 Mbit/s = 200 m  
 12.0 Mbit/s = 100 m

### Norm references / Approvals

- Approval: UL/CSA type CMX in accordance with UL 444 and CSA C22.2 no. 214

### Design

- Stranded bare copper wire
- Foam Skin - core isolation (O2YS)
- Overall screening with copper braid and plastic-laminated aluminium foil
- Screening: wrapped with braided tinned-copper wires
- Outer sheath: PUR compound

### Technical data

- Mutual capacitance**  
(800 Hz): max. 30 nF/km
- Peak operating voltage**  
(not for power applications) 250 V
- Minimum bending radius**  
Flexing: 15 x outer diameter
- Test voltage**  
3600 V DC (3 sec.)
- Characteristic impedance**  
150 ± 15 Ohm
- Temperature range**  
Flexing: -30°C to +70°C  
Fixed installation: -40°C to +80°C

Article number	Article designation	Number of pairs and conductor diameter (mm)	Outer diameter (mm)	Copper index (kg/km)	Weight (kg/km)
<b>Highly flexible application</b>					
2170322	UNITRONIC® BUS PB FD P FC	1 x 2 x 0.64	8.0	26.0	79

Unless specified otherwise, the shown product values are nominal values. Detailed values (e.g. tolerances) are available upon request.  
 Copper price basis: EUR 150/100kg. Refer to catalogue appendix T17 for the definition and calculation of copper-related surcharges.  
 Please find our standard lengths at: [www.lappkabel.de/en/cable-standardlengths](http://www.lappkabel.de/en/cable-standardlengths)  
 Packaging size: coil ≤ 30 kg or ≤ 250 m, otherwise drum  
 Please specify the preferred type of packaging (e.g. 1 x 500 m drum or 5 x 100 m coils).  
 SIMATIC® is a registered trademark of SIEMENS AG. FIP is a registered trademark of World FIP  
 Lapp Kabel is a member of the PROFIBUS user organisation (PNO)  
 Photographs are not to scale and do not represent detailed images of the respective products.

### Accessories

- EPIC® Data Connectors refer to page 69
- FC STRIP stripping tool



## UNITRONIC® BUS PB FD FRNC FC

Highly flexible application



### ■ Benefits

- Fast Connect (FC) system
- For use where the combination of a halogen-free outer sheath with properties similar to PUR and enhanced flame-retardance is required
- For highly flexible applications (power chains, moving machine parts)
- Cables can be used for PROFIBUS-DP as well as PROFIBUS-FMS and FIP

### ■ Application range

- For highly flexible use in energy supply chains or permanently moving machines and linear robots
- This cable provides special advantages for use in sensitive areas where fire propagation must be avoided and the presence of toxic fumes would cause personal injury and damage to equipment.

### ■ Product features

- The cable is UL/CSA-approved (CMG)
- Halogen-free
- High flame retardancy in accordance with IEC 60332-3 and FT4
- Oil-resistant
- Based on the bit rates listed, in accordance with PNO specifications the following maximum cable lengths for a bus segment apply (cable type A, PROFIBUS-DP):  
93.75 kbit/s = 1200 m  
187.5 kbit/s = 1000 m  
500 kbit/s = 400 m  
1.5 Mbit/s = 200 m  
12.0 Mbit/s = 100 m

### ■ Design

- Stranded bare copper wire
- Foam Skin - core isolation (O2YS)
- Overall screening with copper braid and plastic-laminated aluminium foil
- Screening: wrapped with braided tinned-copper wires
- Outer sheath: PUR compound

### ■ Technical data

- Mutual capacitance**  
nom. 28 nF/km
- Peak operating voltage**  
(not for power applications) 250 V
- Minimum bending radius**  
Fixed installation: 10 x outer diameter  
Flexing: 15 x outer diameter
- Test voltage**  
Core/core: 1500 V rms
- Characteristic impedance**  
(3 - 20 MHz): 150 ± 15 Ohm
- Temperature range**  
Flexing: -30°C to +70°C  
Fixed installation: -40°C to +80°C

Article number	Article designation	Number of pairs and conductor diameter (mm)	Outer diameter (mm)	Copper index (kg/km)	Weight (kg/km)
<b>UNITRONIC® BUS PB FD FRNC FC</b>					
2170854	UNITRONIC® BUS PB FD FRNC FC	1x2x0,64	8.0	26.0	75

Unless specified otherwise, the shown product values are nominal values. Detailed values (e.g. tolerances) are available upon request.  
Copper price basis: EUR 150/100kg. Refer to catalogue appendix T17 for the definition and calculation of copper-related surcharges.  
Please find our standard lengths at: [www.lappkabel.de/en/cable-standardlengths](http://www.lappkabel.de/en/cable-standardlengths)  
Packaging size: coil ≤ 30 kg or ≤ 250 m, otherwise drum  
Please specify the preferred type of packaging (e.g. 1 x 500 m drum or 5 x 100 m coils).  
Lapp Kabel is a member of the PROFIBUS user organisation (PNO)  
Photographs are not to scale and do not represent detailed images of the respective products.

### ■ Accessories

- EPIC® Data Connectors refer to page 69
- FC STRIP stripping tool



## UNITRONIC® BUS PB FD P COMBI

Highly flexible application

LAPP KABEL STÜTGART UNITRONIC® BUS PB FD P COMBI

### Benefits

- For use where the combination of a halogen-free outer sheath with properties similar to PUR and enhanced flame-retardance is required
- For highly flexible applications (power chains, moving machine parts)
- Cables can be used for PROFIBUS-DP as well as PROFIBUS-FMS and FIP

### Application range

- PROFIBUS DP (in accordance with DIN 19245 and EN 50170, e.g. for SIEMENS SIMATIC® NET, also suitable for FIP - Factory Instrumentation Protocol).

### Product features

- HYBRID: cable for data transmission + power supply
- Flame-retardant according to IEC 60332.1.2

### Design

- Cores for Power Supply 3 x 1.0 mm<sup>2</sup> (AWG 18)
- Core insulation: Based on Polyolefin
- PUR-based outer sheath

### Technical data

- Mutual capacitance** (800 Hz): max. 30 nF/km
- Peak operating voltage** (not for power applications) 100 V
- Minimum bending radius** Flexing: 145 mm
- Test voltage** Core/core: 600 V
- Characteristic impedance** 150 ± 15 Ohm
- Temperature range** Flexing: -5°C to +50°C Fixed installation: -40°C to +80°C

Article number	Article designation	Number of pairs and conductor diameter (mm)	Outer diameter (mm)	Copper index (kg/km)	Weight (kg/km)
<b>Highly flexible application</b>					
2170227	UNITRONIC® BUS PB FD P COMBI	1 x 2 x 0.64 Ø + 3 x 1.0 mm <sup>2</sup>	10.1	59.0	125

Unless specified otherwise, the shown product values are nominal values. Detailed values (e.g. tolerances) are available upon request. Copper price basis: EUR 150/100kg. Refer to catalogue appendix T17 for the definition and calculation of copper-related surcharges. Please find our standard lengths at: [www.lappkabel.de/en/cable-standardlengths](http://www.lappkabel.de/en/cable-standardlengths) Packaging size: coil ≤ 30 kg or ≤ 250 m, otherwise drum Please specify the preferred type of packaging (e.g. 1 x 500 m drum or 5 x 100 m coils). SIMATIC® is a registered trademark of SIEMENS AG. FIP is a registered trademark of World FIP Lapp Kabel is a member of the PROFIBUS user organisation (PNO) Photographs are not to scale and do not represent detailed images of the respective products.



## UNITRONIC® BUS PB FD P HYBRID

Highly flexible application

LAPP KABEL STÜTGART UNITRONIC® BUS PB FD P HYBRID

### Benefits

- For use where the combination of a halogen-free outer sheath with properties similar to PUR and enhanced flame-retardance is required
- For highly flexible applications (power chains, moving machine parts)
- Cables can be used for PROFIBUS-DP as well as PROFIBUS-FMS and FIP

### Application range

- PROFIBUS DP (in accordance with DIN 19245 and EN 50170, e.g. for SIEMENS SIMATIC® NET, also suitable for FIP - Factory Instrumentation Protocol).

### Product features

- HYBRID: cable for data transmission + power supply
- Flame-retardant according IEC 60332-1-2
- Oil-resistant

### Design

- Cores for Power Supply 4 x 1.5 mm<sup>2</sup> (AWG 16)

### Technical data

- Mutual capacitance** (800 Hz): max. 30 nF/km
- Peak operating voltage** (not for power applications) 100 V
- Minimum bending radius** Flexing: 15 x outer diameter
- Test voltage** Core/core: 600 V Core/screen: 600 V
- Characteristic impedance** 150 ± 15 Ohm
- Temperature range** Flexing: -30°C to +60°C Fixed installation: -40°C to +70°C

Article number	Article designation	Number of pairs and conductor diameter (mm)	Outer diameter (mm)	Copper index (kg/km)	Weight (kg/km)
<b>Highly flexible application</b>					
2170495	UNITRONIC® BUS PB FD P HYBRID	1 x 2 x 0.64 Ø + 4 x 1.5 mm <sup>2</sup>	11.3	89.0	148

Unless specified otherwise, the shown product values are nominal values. Detailed values (e.g. tolerances) are available upon request. Copper price basis: EUR 150/100kg. Refer to catalogue appendix T17 for the definition and calculation of copper-related surcharges. Please find our standard lengths at: [www.lappkabel.de/en/cable-standardlengths](http://www.lappkabel.de/en/cable-standardlengths) Packaging size: coil ≤ 30 kg or ≤ 250 m, otherwise drum Please specify the preferred type of packaging (e.g. 1 x 500 m drum or 5 x 100 m coils). SIMATIC® is a registered trademark of SIEMENS AG. FIP is a registered trademark of World FIP Lapp Kabel is a member of the PROFIBUS user organisation (PNO) Photographs are not to scale and do not represent detailed images of the respective products.





## UNITRONIC® BUS PB FD Y HYBRID

Highly flexible application



### Benefits

- For highly flexible applications (power chains, moving machine parts)
- Cables can be used for PROFIBUS-DP as well as PROFIBUS-FMS and FIP
- CL3 for installation on trays

### Application range

- PROFIBUS DP (in accordance with DIN 19245 and EN 50170, e.g. for SIEMENS SIMATIC® NET, also suitable for FIP - Factory Instrumentation Protocol).

### Product features

- HYBRID: cable for data transmission + power supply

### Norm references / Approvals

- With UL/CSA approval (CMG, CL3, SUN RES, Oil Res I)
- Flame-retardant according to CSA FT4 UL Vertical-Tray Flame Test
- Oil-resistant according to UL OIL RES I

### Design

- Outer sheath: special PVC compound
- Cores for Power Supply  
4 x 1.5 mm<sup>2</sup> (AWG16)

### Technical data

- Peak operating voltage**  
600 V (not for power applications)
- Minimum bending radius**  
Fixed installation:  
10 x cable diameter  
Flexing: 15 x outer diameter
- Test voltage**  
Core/core: 2000 V  
Core/screen: 2000 V
- Characteristic impedance**  
150 ± 15 Ohm
- Temperature range**  
-5°C to +80°C

Article number	Article designation	Number of pairs and conductor diameter (mm)	Outer diameter (mm)	Copper index (kg/km)	Weight (kg/km)
<b>Highly flexible application</b>					
2170875	UNITRONIC® BUS PB FD Y HYBRID	1 x 2 x 0.64 Ø + 4 x 1.5 mm <sup>2</sup>	11.3	89.0	155

Unless specified otherwise, the shown product values are nominal values. Detailed values (e.g. tolerances) are available upon request.  
 Copper price basis: EUR 150/100kg. Refer to catalogue appendix T17 for the definition and calculation of copper-related surcharges.  
 Please find our standard lengths at: [www.lappkabel.de/en/cable-standardlengths](http://www.lappkabel.de/en/cable-standardlengths)  
 Packaging size: coil ≤ 30 kg or ≤ 250 m, otherwise drum  
 Please specify the preferred type of packaging (e.g. 1 x 500 m drum or 5 x 100 m coils).  
 SIMATIC® is a registered trademark of SIEMENS AG. FIP is a registered trademark of World FIP  
 Lapp Kabel is a member of the PROFIBUS user organisation (PNO)  
 Photographs are not to scale and do not represent detailed images of the respective products.



## UNITRONIC® BUS PB TORSION

Highly flexible application

LAPP KABEL STUTTGART UNITRONIC® BUS PB TORSION



### Benefits

- For use where the combination of a halogen-free outer sheath with properties similar to PUR and enhanced flame-retardance is required
- Cables can be used for PROFIBUS-DP as well as PROFIBUS-FMS and FIP

### Application range

- PROFIBUS DP (in accordance with DIN 19245 and EN 50170, e.g. for SIEMENS SIMATIC® NET, also suitable for FIP - Factory Instrumentation Protocol).

### Product features

- TORSION: for torsional stress, e.g. robot application; ± 180° per 1 m
- Halogen-free
- Flame-retardant according IEC 60332-1-2
- Based on the bit rates listed, in accordance with PNO specifications the following maximum cable lengths for a bus segment apply (cable type A, PROFIBUS-DP):  
 93.75 kbit/s = 1200 m  
 187.5 kbit/s = 1000 m  
 500 kbit/s = 400 m  
 1.5 Mbit/s = 200 m  
 12.0 Mbit/s = 100 m

### Norm references / Approvals

- Approval: UL type CMX in accordance with UL 444

### Design

- PE core insulation

### Technical data

- Mutual capacitance**  
(800 Hz): max. 30 nF/km
- Peak operating voltage**  
(not for power applications)  
300 V
- Torsion movement in WTG**  
Max. torsion load  
± 180°/m
- Minimum bending radius**  
Fixed installation: 4 x outer diameter  
Flexing: 7.5 x outer diameter
- Test voltage**  
3600 V DC (3 sec.)
- Characteristic impedance**  
150 ± 15 Ohm
- Temperature range**  
Operating temperature: -25°C to 75°C  
Storage temp.: -40°C to 80°C

Article number	Article designation	Number of pairs and conductor diameter (mm)	Outer diameter (mm)	Copper index (kg/km)	Weight (kg/km)
<b>Highly flexible application</b>					
2170332	UNITRONIC® BUS PB TORSION	1 x 2 x 0.8	8.0	31.0	66

Unless specified otherwise, the shown product values are nominal values. Detailed values (e.g. tolerances) are available upon request.  
 Copper price basis: EUR 150/100kg. Refer to catalogue appendix T 17 for the definition and calculation of copper-related surcharges.  
 Please find our standard lengths at: [www.lappkabel.de/en/cable-standardlengths](http://www.lappkabel.de/en/cable-standardlengths)  
 Packaging size: coil ≤ 30 kg or ≤ 250 m, otherwise drum  
 Please specify the preferred type of packaging (e.g. 1 x 500 m drum or 5 x 100 m coils).  
 SIMATIC® is a registered trademark of SIEMENS AG. FIP is a registered trademark of World FIP  
 Lapp Kabel is a member of the PROFIBUS user organisation (PNO)  
 Photographs are not to scale and do not represent detailed images of the respective products.

### Accessories

- EPIC® Data Connectors refer to page 69



## UNITRONIC® BUS PB FESTOON

Highly flexible application



### ■ Benefits

- Cables can be used for PROFIBUS-DP as well as PROFIBUS-FMS and FIP
- CL3 for installation on trays

### ■ Application range

- PROFIBUS DP (in accordance with DIN 19245 and EN 50170, e.g. for SIEMENS SIMATIC® NET, also suitable for FIP - Factory Instrumentation Protocol).

### ■ Product features

- FESTOON: for cable trolley (festoon)
- Based on the bit rates listed, in accordance with PNO specifications the following maximum cable lengths for a bus segment apply  
(cable type A, PROFIBUS-DP):  
93.75 kbit/s = 1200 m  
187.5 kbit/s = 1000 m  
500 kbit/s = 400 m  
1.5 Mbit/s = 200 m  
12.0 Mbit/s = 100 m

### ■ Norm references / Approvals

- With UL/CSA approval (CMG, CL3, SUN RES, Oil Res I)
- Flame-retardant according to CSA FT4 UL Vertical-Tray Flame Test
- Oil-resistant according to UL OIL RES I

### ■ Design

- Outer sheath: special PVC compound

### ■ Technical data

- Mutual capacitance**  
(800 Hz): max. 30 nF/km
- Peak operating voltage**  
600 V (not for power applications)
- Minimum bending radius**  
Flexing: 70 mm  
Fixed installation: 30 mm once
- Test voltage**  
Core/core: 2000 V
- Characteristic impedance**  
150 ± 15 Ohm
- Temperature range**  
Flexing: -5°C to +70°C  
Fixed installation: -40°C to +80°C

Article number	Article designation	Number of pairs and conductor diameter (mm)	Outer diameter (mm)	Copper index (kg/km)	Weight (kg/km)
<b>Highly flexible application</b>					
2170331	UNITRONIC® BUS PB Festoon	1 x 2 x 0.64	8.0	26.0	64

Unless specified otherwise, the shown product values are nominal values. Detailed values (e.g. tolerances) are available upon request.  
Copper price basis: EUR 150/100kg. Refer to catalogue appendix T 17 for the definition and calculation of copper-related surcharges.  
Please find our standard lengths at: [www.lappkabel.de/en/cable-standardlengths](http://www.lappkabel.de/en/cable-standardlengths)  
Packaging size: coil ≤ 30 kg or ≤ 250 m, otherwise drum  
Please specify the preferred type of packaging (e.g. 1 x 500 m drum or 5 x 100 m coils).  
SIMATIC® is a registered trademark of SIEMENS AG. FIP is a registered trademark of World FIP  
Lapp Kabel is a member of the PROFIBUS user organisation (PNO)  
Photographs are not to scale and do not represent detailed images of the respective products.

### ■ Accessories

- EPIC® Data Connectors refer to page 69



## EPIC® Data PROFIBUS Connectors with Screw Terminals

**Info**

- Fully compatible with market standard
- Optional LED diagnostics



### Benefits

- Small design
- Secure PROFIBUS network connection
- Improved electromagnetic compatibility (EMC) by metallized housing
- Easy connection of PROFIBUS cable by proven screw clamp connection
- Standardised interfaces

### Application range

- Automation technology
- Mechanical engineering
- Plant engineering
- Tool shop
- Control engineering

### Product features

- Screw termination
- Switchable bus termination is integrated
- Switch can also be operated when the connector is plugged and setting is clearly visible
- When used as a through connector (two cable connections, node) the switch must be in the "OFF" position. If used as a terminating connector (one cable connection, segment end), the switch must be in the "ON" position.
- If the switch is in the "ON" position the outgoing bus cable is disconnected

### Norm references / Approvals

- D-Sub (9 pos) pin assignment in accordance with PROFIBUS
- IEC 61158, IEC 61784
- UL File: E331560

### Design

- D-Sub plug, 9-pin, fixing screws 4-40 UNC
- Metallised housing
- Cable outlet: 35° / 90° / 180°
- For cable outer diameter: 5 ... 8 mm
- Status LEDs indicate: bus operation - (green) station transmission - (blue) terminating resistance - (orange)

### Suitable cables

- Cables for bus systems PROFIBUS-DP/ FMS/FIP Page 51
- Cables for bus system PROFIBUS-PA

### Suitable tools

- Kraftform® adjustable torque screwdriver/ Kraftform Kompakt® Set

### Technical data

**Dimensions**  
 54 mm x 40 mm x 17 mm - 35°  
 64 mm x 40 mm x 17 mm - 90°  
 68 mm x 40 mm x 17 mm - 180°  
 (LxWxH)

**Connection type**  
 Screwing

**Degree of soiling**  
 2

**Weight**  
 Approx. 40 g

**Protection rating**  
 IP20

**Terminating resistor**  
 Integrated resistor integrated

**Transmission rate**  
 max. 12 MBit/s

**Interfaces**  
 PROFIBUS station:  
 D-Sub socket, 9-pin  
 PROFIBUS cable:  
 4 terminal blocks for wires  
 up to 1.0 mm<sup>2</sup> (solid / flexible)

**Current consumption**  
 max. 12,5 mA (35 mA - LED version)

**Permissible ambient conditions**  
 Operating temperature:  
 -25°C to +85°C  
 Relative humidity:  
 max. 75 % at +25°C

**Supply voltage**  
 4.75 to 5.25 V DC  
 (supplied from terminal)

Article number	Article designation	Cable outlet	PG	Diagnostic LEDs	Pieces / PU
<b>EPIC® Data PROFIBUS Connectors with 35° cable outlet</b>					
21700507	ED-PB-35	35°	no	no	1
21700506	ED-PB-35-PG	35°	yes	no	1
<b>EPIC® Data PROFIBUS Connectors with 90° cable outlet</b>					
21700504	ED-PB-90	90°	no	no	1
21700503	ED-PB-90-PG	90°	yes	no	1
<b>EPIC® Data PROFIBUS Connectors with 90° cable outlet and LED diagnostic</b>					
21700530	ED-PB-90-LED	90°	no	yes	1
21700529	ED-PB-90-PG-LED	90°	yes	yes	1
<b>EPIC® Data PROFIBUS Connectors with 180° (axial) cable outlet</b>					
21700505	ED-PB-AX	180°	no	no	1

Unless specified otherwise, the shown product values are nominal values. Detailed values (e.g. tolerances) are available upon request.  
 PG = programming interface (= 2nd D-Sub)  
 Photographs are not to scale and do not represent detailed images of the respective products.





## EPIC® Data PROFIBUS Connectors Fast Connect



**Info**

- Fully compatible with market standard
- Optional LED diagnostics

### Benefits

- Cost-saving due to quick installation (Plug & Play)
- Small design
- Secure PROFIBUS network connection
- Simple to use, as compatible with the market standard
- Improved electromagnetic compatibility (EMC) by metallized housing

### Application range

- Automation technology
- Mechanical engineering
- Plant engineering
- Tool shop
- Control engineering

### Product features

- Visual bus connection control
- Switchable bus termination is integrated
- When used as a through connector (two cable connections, node) the switch must be in the "OFF" position. If used as a terminating connector (one cable connection, segment end), the switch must be in the "ON" position.
- If the switch is in the "ON" position the outgoing bus cable is disconnected
- Type 'FC': for solid conductor or 7-wire stranded conductor  
Type 'FC-FLEX': for 19- or 7-wire stranded conductor

### Norm references / Approvals

- IEC 61158, IEC 61784
- UL File: E331560
- D-Sub (9 pos) pin assignment in accordance with PROFIBUS

### Design

- D-Sub plug, 9-pin, fixing screws 4-40 UNC
- Metallised housing
- Cable outlet: 35° / 90° / 180°
- For cable outer diameter: 8 mm
- Status LEDs indicate: bus operation - (green) station transmission - (blue) terminating resistance - (orange)

### Suitable cables

- Cables for bus systems PROFIBUS-DP/ FMS/FIP Page 51
- Cables for bus system PROFIBUS-PA

### Suitable tools

- FC STRIP stripping tool
- Kraftform® adjustable torque screwdriver/ Kraftform Kompakt® Set

### Technical data

**Dimensions**  
 95 mm x 70 mm x 17 mm - 35°  
 72 mm x 40 mm x 17 mm - 90°  
 70 mm x 35 mm x 17 mm - 180°  
 (LxWxH)

**Connection type**  
 Fast Connect

**Degree of soiling**  
 2

**Weight**  
 Approx. 50 g

**Protection rating**  
 IP20

**Terminating resistor**  
 Integrated resistor integrated

**Transmission rate**  
 max. 12 MBit/s

**Interfaces**  
 PROFIBUS station:  
 SUB-D socket, 9-pin  
 PROFIBUS cable:  
 FC standard cable, Ø 0.64 mm

**Current consumption**  
 max. 12,5 mA (35 mA - LED version)

**Permissible ambient conditions**  
 Operating temperature:  
 -25 °C to +85 °C  
 Relative humidity:  
 max. 75 % at +25 °C  
 \*The max. temperature for UL is 60 °C.

**Supply voltage**  
 4.75 to 5.25 V DC  
 (supplied from terminal)

Article number	Article designation	Cable outlet	PG	Diagnostic LEDs	Pieces / PU
<b>EPIC® Data PROFIBUS Connectors with 35° cable outlet</b>					
21700511	ED-PB-35-FC	35°	no	no	1
21700513	ED-PB-35-PG-FC	35°	yes	no	1
21700514	ED-PB-35-FC-FLEX	35°	no	no	1
21700515	ED-PB-35-PG-FC-FLEX	35°	yes	no	1
<b>EPIC® Data PROFIBUS Connectors with 90° cable outlet</b>					
21700502	ED-PB-90-FC	90°	no	no	1
21700501	ED-PB-90-PG-FC	90°	yes	no	1
21700528	ED-PB-90-FC-FLEX	90°	no	no	1
21700527	ED-PB-90-PG-FC-FLEX	90°	yes	no	1
<b>EPIC® Data PROFIBUS Connectors with 90° cable outlet and LED diagnostic</b>					
21700547	ED-PB-90-LED-FC	90°	no	yes	1
21700546	ED-PB-90-PG-LED-FC	90°	yes	yes	1
21700549	ED-PB-90-LED-FC-FLEX	90°	no	yes	1
21700539	ED-PB-90-PG-LED-FC-FLEX	90°	yes	yes	1
<b>EPIC® Data PROFIBUS Connectors with 180° (axial) cable outlet</b>					
21700544	ED-PB-AX-FC	180° axial	no	no	1
21700545	ED-PB-AX-FC-FLEX	180° axial	no	no	1

Unless specified otherwise, the shown product values are nominal values. Detailed values (e.g. tolerances) are available upon request.  
 PG = programming interface (= 2nd D-Sub)  
 Photographs are not to scale and do not represent detailed images of the respective products.



## EPIC® Data PROFIBUS Connectors ATEX Screw Terminals

**Info**

- Fully compatible with market standard



### Benefits

- For use within intrinsically-safe circuits in zone 2 areas with an explosion hazard (explosive gas atmosphere occurs only rarely and briefly)
- Standardised interfaces
- Improved electromagnetic compatibility (EMC) by metallized housing
- Easy connection of bus cables by proven screw clamp connection
- Secure PROFIBUS network connection

### Application range

- Automation technology
- Mechanical engineering
- Plant engineering
- Tool shop
- Control engineering

### Product features

- Screw termination
- Switchable bus termination is integrated
- Switch can also be operated when the connector is plugged and setting is clearly visible
- When used as a through connector (two cable connections, node) the switch must be in the "OFF" position. If used as a terminating connector (one cable connection, segment end), the switch must be in the "ON" position.
- If the switch is in the "ON" position the outgoing bus cable is disconnected

### Norm references / Approvals

- UL File: E331560
- D-Sub (9 pos) pin assignment in accordance with PROFIBUS
- DIN EN 60079-0:2006, DIN 60079-15:2005 category 3G zone 2

### Design

- D-Sub plug, 9-pin, fixing screws 4-40 UNC
- Metallised housing
- Cable outlet 90°
- For cable outer diameter: 5 ... 8 mm
- (-PG) With additional programming / diagnostic interface: D-Sub socket, 9-pin

### Suitable cables

- Cables for bus system PROFIBUS-PA

### Suitable tools

- Kraftform® adjustable torque screwdriver / Kraftform Kompakt® Set

### Technical data

- Dimensions**  
64 mm x 40 mm x 17 mm (LxWxH)
- Connection type**  
Screwing
- Degree of soiling**  
2
- Weight**  
Approx. 40 g
- Protection rating**  
IP20
- Cable outlet**  
90°
- Terminating resistor**  
Integrated resistor combination that is connected by a sliding switch
- Transmission rate**  
max. 12 MBit/s
- Interfaces**  
PROFIBUS station:  
D-Sub socket, 9-pin  
PROFIBUS cable:  
4 terminal blocks for wires up to 1.0 mm² (solid / flexible)
- Current consumption**  
max. 12.5 mA
- Permissible ambient conditions**  
Operating temperature:  
-20°C to +60°C  
Transport and storage temperature:  
-25°C to +80°C  
Relative humidity:  
max. 75 % at +25°C
- Supply voltage**  
4.75 to 5.25 V DC  
(supplied from terminal)

Article number	Article designation	Cable outlet	PG	Pieces / PU
<b>EPIC® Data PROFIBUS Connectors</b>				
21700543	ED-PB-90-ATEX	90°	no	1
21700542	ED-PB-90-PG-ATEX	90°	yes	1

Unless specified otherwise, the shown product values are nominal values. Detailed values (e.g. tolerances) are available upon request.

PG = programming interface (= 2nd D-Sub)

Photographs are not to scale and do not represent detailed images of the respective products.

Note: For further important information, see the package insert (ATEX-Information\_ED-PB-90... ATEX.pdf).



## EPIC® Data PROFIBUS Connectors REPEATER



**Info**

- Alternative solution to conventional PROFIBUS repeaters
- No additional space needed in the cabinet

### Benefits

- Easy extensions of the PROFIBUS network topology:
  - up to 3 repeaters
  - 1 additional PROFIBUS segment
  - galvanic isolation
- Regeneration of data signal (slope, power and mark-to-space ratio)
- Cost-saving due to quick installation (Plug & Play)
- Diagnostic LED is integrated
- No additional space needed in the cabinet

### Application range

- Automation technology
- Mechanical engineering
- Plant engineering
- Tool shop
- Control engineering

### Product features

- Can also be used in MPI networks
- Can be used as a bus extension or spur line (can be plugged directly to the PG-port of an existing PROFIBUS connector)
- 5 V power supply from the PROFIBUS connection enables usage on all PROFIBUS devices
- LED diagnostic and status indicators
- Transmission rate → max. segment length:
 

9.6 KBit/s	1000 m
187.5 KBit/s	1000 m
500 KBit/s	400 m
1.5 MBit/s	200 m
3 MBit/s	100 m
12 MBit/s	100 m

### Norm references / Approvals

- D-Sub (9 pos) pin assignment in accordance with PROFIBUS
- IEC 61158, IEC 61784
- UL File: E331560

### Design

- D-Sub plug, 9-pin, fixing screws 4-40 UNC
- Metallised housing
- An external 24 V supply is not necessary
- Status LEDs (Power, Error, Bus) for diagnostic display
- For cable outer diameter: 5 ... 8 mm

### Suitable cables

- Cables for bus systems PROFIBUS-DP/ FMS/FIP Page 51
- Cables for bus system PROFIBUS-PA

### Suitable tools

- Kraftform® adjustable torque screwdriver/ Kraftform Kompakt® Set

### Technical data

**Dimensions**  
64 mm x 40 mm x 17 mm (LxWxH)

**Connection type**  
Screwing

**Degree of soiling**  
2

**Weight**  
Approx. 40 g

**Protection rating**  
IP20

**Cable outlet**  
90°

**Transmission rate**  
9.6 Kbit/s to 12 MBit/s  
autodetection

**Interfaces**  
Connection:  
D-Sub socket, 9-pin  
PROFIBUS-cable:  
4 terminal blocks for wires up to 1.0 mm<sup>2</sup>

Protocol:  
PROFIBUS DP in accordance with EN 50170

**Current consumption**  
typ. 100 mA

**Permissible ambient conditions**  
Operating temperature:  
0°C to +60°C  
Transport and storage temperature:  
-25°C to +75°C

**Supply voltage**  
+5,0 VDC  
(supplied from terminal)

Article number	Article designation	Cable outlet	PG	Diagnostic LEDs	Pieces / PU
<b>EPIC® Data PROFIBUS Connectors</b>					
21700541	ED-PB-90-RP-PG	90°	yes	yes	1

Unless specified otherwise, the shown product values are nominal values. Detailed values (e.g. tolerances) are available upon request.

PG = programming interface (= 2nd D-Sub)

For the detailed manual please refer to [www.lappautomation.com](http://www.lappautomation.com)

Photographs are not to scale and do not represent detailed images of the respective products.



## EPIC® Data PROFIBUS Connectors M 12

**Info**

- Fully compatible with market standard

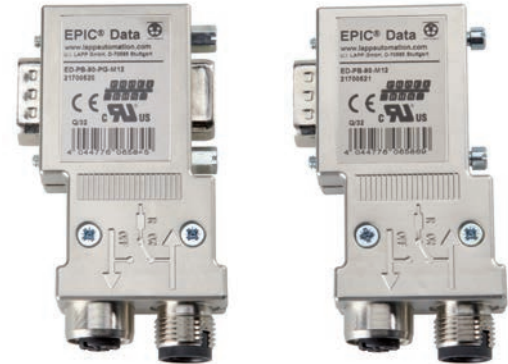

### Benefits

- Cost-saving due to quick installation (Plug & Play)
- Secure PROFIBUS network connection
- Suitable for assembled M12 PB cables
- Simple to use, as compatible with the market standard
- Standardised interfaces

### Application range

- Automation technology
- Mechanical engineering
- Plant engineering
- Tool shop
- Control engineering

### Product features

- No loose parts
- Switchable bus termination is integrated
- Switch can also be operated when the connector is plugged and setting is clearly visible
- When used as a through connector (two cable connections, node) the switch must be in the "OFF" position. If used as a terminating connector (one cable connection, segment end), the switch must be in the "ON" position.
- If the switch is in the "ON" position the outgoing bus cable is disconnected

### Norm references / Approvals

- D-Sub (9 pos) pin assignment in accordance with PROFIBUS
- IEC 61158, IEC 61784
- UL File: E331560

### Design

- D-Sub plug, 9-pin, fixing screws 4-40 UNC
- 5-pin connector, M12, B-coded
- Metallised housing
- (-PG) With additional programming/diagnostic interface: D-Sub socket, 9-pin

### Suitable cables

- PROFIBUS cable: M12 connector on free conductor end Page 129
- PROFIBUS Cable: M12 connector on M12 socket Page 130

### Technical data

**Dimensions**  
70 mm x 40 mm x 17 mm (L x W x H)

**Connection type**  
M12

**Degree of soiling**  
2

**Weight**  
approx. 60 g

**Protection rating**  
IP20

**Cable outlet**  
90°

**Terminating resistor**  
Integrated resistor combination that is connected by a sliding switch

**Transmission rate**  
max. 12 MBit/s

**Interfaces**  
PROFIBUS station:  
D-Sub socket, 9-pin  
PROFIBUS cable:  
M12 PB system cabling

**Current consumption**  
max. 12.5 mA

**Permissible ambient conditions**  
Operating temperature:  
0°C to +60°C  
Transport and storage temperature:  
-25°C to +80°C  
Relative humidity:  
max. 75 % at +25°C

**Supply voltage**  
4.75 to 5.25 V DC  
(supplied from terminal)

Article number	Article designation	Cable outlet	Adjustable termination resistance	PG	Pieces / PU
<b>EPIC® Data PROFIBUS Connectors</b>					
21700521	ED-PB-90-M12	90°	yes	no	1
<b>EPIC® Data PROFIBUS Connectors</b>					
21700520	ED-PB-PG-90-M12	90°	yes	yes	1

Unless specified otherwise, the shown product values are nominal values. Detailed values (e.g. tolerances) are available upon request.  
PG = programming interface (= 2nd D-Sub)  
Photographs are not to scale and do not represent detailed images of the respective products.



New

## EPIC® Data PROFIBUS Connector (full-metal)

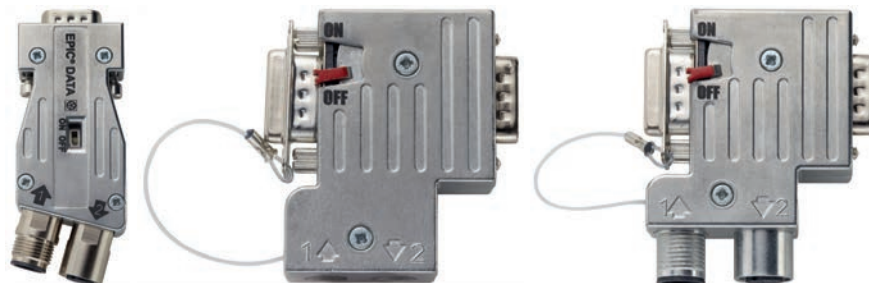

Info

- High EMC protection

### Benefits

- Optimum EMC protection
- Very flexible in use
- Robust and failsafe design in harsh environments.
- Secure PROFIBUS network connection
- Cost-saving due to quick installation (Plug & Play)

### Application range

- Automation technology
- Control engineering
- Mechanical engineering
- Plant engineering
- Tool shop

### Product features

- Extended temperature range
- High mechanical durability (200 contact durability)
- Less transmission loss
- Switchable bus termination is integrated
- No loose parts

### Norm references / Approvals

- D-Sub (9 pos) pin assignment in accordance with PROFIBUS
- IEC 61158, IEC 61784

### Design

- D-Sub plug, 9-pin, fixing screws 4-40 UNC
- Full-metal housing (ZnAl)
- With additional programming/diagnostic interface (90° and 35° version): D-Sub socket, 9-pin
- With undetachable EMC connector protection (PG port) at angled variants
- 360° shielding of housing

### Suitable cables

- PROFIBUS cable: M 12 connector on free conductor end Page 129
- PROFIBUS Cable: M 12 connector on M 12 socket Page 130

### Suitable tools

- Kraffform® adjustable torque screwdriver/ Kraffform Kompakt® Set

### Technical data



#### Dimensions

see technical data sheet

#### Connection type

linternal cable clamp: cage clamp terminal

#### Degree of soiling

2



#### Weight

Approx. 100 g



#### Protection rating

IP 30

#### Cable outlet

90°, 35° and axial

#### Terminating resistor

Integrated resistor combination that is connected by a sliding switch

#### Transmission rate

max. 12 MBit/s

#### Interfaces

##### PROFIBUS station:

D-Sub socket, 9-pin

##### PROFIBUS cable:

- Version:

M 12 PROFIBUS system cabling

- Version:

Spring type for system cabling

Wire size: 0,08 - 0,5 mm<sup>2</sup>

(AWG 28 - AWG 14)

Cable diameter: 8 - 9 mm



#### Permissible ambient conditions

Operating temperature:

-20°C to +70°C

Relative humidity:

max. 75 % at +25°C

#### Supply voltage

4.75 to 5.25 V DC

(supplied from terminal)

Article number	Article designation	Cable outlet	PG	Pieces / PU
<b>EPIC® Data PROFIBUS Connectors (full-metal) with M 12 connection (B-coded, 5-pin)</b>				
21700563	ED-PB-AX-M 12-PRO	axial	no	1
21700561	ED-PB-35-PG-M 12-PRO	35°	yes	1
21700562	ED-PB-90-PG-M 12-PRO	90°	yes	1
<b>EPIC® Data PROFIBUS Connectors (full-metal) with internal spring type connection</b>				
21700566	ED-PB-AX-M 12-PRO	axial	no	1
21700564	ED-PB-35-PG-ST-PRO	35°	yes	1
21700565	ED-PB-90-PG-ST-PRO	90°	yes	1

Unless specified otherwise, the shown product values are nominal values. Detailed values (e.g. tolerances) are available upon request.

PG = programming interface (= 2nd D-Sub)

Photographs are not to scale and do not represent detailed images of the respective products.





**New**

## EPIC® Data PROFIBUS Connector (Optical Link Modul)

**Info**

- Fully functioning PROFIBUS repeater with integrated optical interface



**Benefits**

- Easy covering of large distances
- Cost-saving due to quick installation (Plug & Play)
- Galvanic isolation in case of potential differences within PROFIBUS network
- For EMC critical environments
- Regeneration of data signal (slope, power and mark-to-space ratio)

**Application range**

- Automation technology
- Control engineering
- Mechanical engineering
- Plant engineering
- Tool shop

**Product features**

- Integrated repeater functionality
- Switchable bus termination is integrated
- Diagnostic LEDs (blue, green, red, yellow)
- Max. distance:  
POF fiber: 65 m  
PCF fiber: 250 m

**Norm references / Approvals**

- D-Sub (9 pos) pin assignment in accordance with PROFIBUS
- IEC 61158, IEC 61784

**Design**

- D-Sub plug, 9-pin, fixing screws 4-40 UNC
- Metallised housing
- With additional programming/diagnostic interface: Sub-D socket, 9-pin
- An external 24 V supply is not necessary
- Connection for optical cable (POF or PCF)

**Suitable cables**

- HITRONIC® POF DUPLEX PE Page 222
- HITRONIC® POF DUPLEX PE-PUR Page 222
- HITRONIC® POF cables for PROFINET Applications Page 223

**Technical data**

**Dimensions**  
64 mm x 40 mm x 17 mm (LxWxH)

**Degree of soiling**  
2

**Weight**  
Approx. 40 g

**Protection rating**  
IP 20

**Cable outlet**  
90°

**Terminating resistor**  
Integrated resistor combination that is connected by a sliding switch

**Transmission rate**  
max. 12 MBit/s

**Interfaces**  
Connection: Sub-D socket, 9-pin  
FO-cable:  
- Polymeric-optical-fiber (POF), 650 nm  
- Polymer-cladded-fiber (PCF), 650 nm  
applicable types of connectors: SMA, BFOC(ST) and HFBR

**Current consumption**  
typ. 100 mA

**Permissible ambient conditions**  
Operating temperature:  
0°C to +60°C  
Transport and storage temperature:  
-25°C to +75°C

**Supply voltage**  
+5,0 VDC  
(supplied from terminal)

Article number	Article designation	Cable outlet	PG	Diagnostic LEDs	Pieces / PU
<b>EPIC® Data PROFIBUS Connectors Fiber Optic Module - HFBR connector</b>					
21700568	ED-PB-90-PG-FO-HFBR-650	90°	yes	yes	1
<b>EPIC® Data PROFIBUS Connectors Fiber Optic Module - SMA connector</b>					
21700569	ED-PB-90-PG-FO-SMA-650	90°	yes	yes	1
<b>EPIC® Data PROFIBUS Connectors Fiber Optic Module - BFOC(ST) connector</b>					
21700570	ED-PB-90-PG-FO-BFOC-650	90°	yes	yes	1

PG = programming interface (= 2nd D-Sub)  
 Applicable optical connectors (POF) included  
 Photographs are not to scale and do not represent detailed images of the respective products.  
 For detailed technical information please refer to the data sheet or installation instructions (www.lappautomation.com)  
 Note: For one optical link 2 modules are required

**Accessories**

- PCF Assembly Sets refer to page 234
- PCF Connector HFBR refer to page 233
- PCF Connector F-SMA and ST(BFOC) refer to page 233
- POF Assembly Sets refer to page 226
- POF Connector F-SMA and ST(BFOC) refer to page 225

**Cables for bus system DeviceNet**

Characteristic impedance: 120 ohm



## UNITRONIC® DeviceNet THICK + THIN



### Application range

- Fixed installation
- DeviceNet™ connects industrial devices e.g. limit switches, photoelectric switches, valve islands, motor starters, drives, PLCs, etc.

### Product features

- Resistant to oils
- Based on proven CAN (Controller Area Network) technology.
- Permissible cable lengths vary with the data rate and the cable thickness
- FRNC Version: Halogene free and flame retardant
- Refer to data sheet for more details

### Norm references / Approvals

- CMG UL/CSA approval 75°C or PLTC, Sun Res
- FRNC variant additionally with Germanischer Lloyd approval

### Design

- Core insulation made of foam skin
- Outer sheath: Halogene free (FRNC) or Polyvinylchlorid (PVC)

### Technical data

- Core identification code**  
Data pair: light blue + white  
Power supply: red + black
- Mutual capacitance**  
(800 Hz): max. 39.8 nF/km
- Peak operating voltage**  
300 V (not for power applications)
- Conductor resistance**  
Thick (loop): max. 45 ohm/km  
Thin (loop): max. 180 ohm/km
- Minimum bending radius**  
Fixed installation: 15 x cable diameter
- Test voltage**  
Core/core: 2000 V
- Characteristic impedance**  
120 ohm
- Temperature range**  
Fixed installation: -25°C to +80°C

Article number	Article designation	Number of pairs and AWG per conductor	Outer diameter (mm)	Copper index (kg/km)	Weight (kg/m)
<b>Halogen-free</b>					
2170340	UNITRONIC® BUS DN THICK FRNC	1x2xAWG 18 + 1x2xAWG 15	12.2	82.8	195
2170341	UNITRONIC® BUS DN THIN FRNC	1x2xAWG24 + 1x2xAWG22	6.9	33.4	69.5
<b>With PVC outer sheath</b>					
2170342	UNITRONIC® BUS DN THICK Y	1x2xAWG 18 + 1x2xAWG 15	12.2	88.4	192
2170343	UNITRONIC® BUS DN THIN Y	1x2xAWG24 + 1x2xAWG22	6.9	33.4	66.9

Unless specified otherwise, the shown product values are nominal values. Detailed values (e.g. tolerances) are available upon request.  
 Copper price basis: EUR 150/100kg. Refer to catalogue appendix T17 for the definition and calculation of copper-related surcharges.  
 Please find our standard lengths at: [www.lappkabel.de/en/cable-standardlengths](http://www.lappkabel.de/en/cable-standardlengths)  
 FRNC means Flame-Retardant, Non-Corrosive; and DeviceNet is a registered trademark of ODVA.  
 Lapp Kabel is a member of the PROFIBUS user organisation (PNO)  
 ECO is the cost-efficient version of article no. 2170342 and 2170343, with a slight modification to the outer sheath and UL/CSA-approved (CMG).  
 Photographs are not to scale and do not represent detailed images of the respective products.



## UNITRONIC® DeviceNet FD THICK+THIN

Highly flexible and UL/CSA-approved

LAPP KABEL STUÏGART UNITRONIC® BUS DN THICK FD P

LAPP KABEL STUÏGART UNITRONIC® BUS DN THIN FD P

### ■ Application range

- For highly flexible applications
- DeviceNet™ connects industrial devices e.g. limit switches, photoelectric switches, valve islands, motor starters, drives, PLCs, etc.

### ■ Product features

- Based on proven CAN (Controller Area Network) technology.
- Permissible cable lengths vary with the data rate and the cable thickness
- Refer to data sheet for more details
- PUR (P) Version: Halogene free
- PVC (Y) Version: Flame retardant (UL FT4)
- UV-resistant (but colour may change after some time)

### ■ Norm references / Approvals

- PUR: UL/CSA-approved (CMX)
- PVC: UL/CSA CMG 75°C FT4 Sun Res Oil Res, at 2170346 also PLTC

### ■ Design

- Core insulation: PE
- Outer sheath of Polyurethan (PUR) or Polyvinylchlorid (PVC)

### ■ Technical data

- Core identification code**  
Data pair: light blue + white  
Power supply: red + black
- Mutual capacitance**  
(800 Hz): max. 39.8 nF/km
- Peak operating voltage**  
300 V (not for power applications)
- Conductor resistance**  
Thick (loop): max. 45 ohm/km  
Thin (loop): max. 180 ohm/km
- Minimum bending radius**  
Fixed installation: 7.5 x cable diameter  
Flexing: 15 x outer diameter
- Test voltage**  
Core/core: 2000 V
- Characteristic impedance**  
120 ohm
- Temperature range**  
PUR: -40°C to +80°C  
PVC: -10°C to +80°C

Article number	Article designation	Number of pairs and AWG per conductor	Outer diameter (mm)	Copper index (kg/km)	Weight (kg/m)
<b>Version P (PUR)</b>					
2170344	UNITRONIC® BUS DN THICK FD P	1x2xAWG18 + 1x2xAWG15	12.2	94.0	184
2170345	UNITRONIC® BUS DN THIN FD P	1x2xAWG24 + 1x2xAWG22	6.9	33.4	67.7
<b>Version Y (PVC)</b>					
2170346	UNITRONIC® BUS DN THICK FD Y	1x2xAWG18 + 1x2xAWG15	12.2	94.0	195
2170347	UNITRONIC® BUS DN THIN FD Y	1x2xAWG24 + 1x 2xAWG22	6.9	33.4	69.8

Unless specified otherwise, the shown product values are nominal values. Detailed values (e.g. tolerances) are available upon request.

Copper price basis: EUR 150/100kg. Refer to catalogue appendix T17 for the definition and calculation of copper-related surcharges.

Please find our standard lengths at: [www.lappkabel.de/en/cable-standardlengths](http://www.lappkabel.de/en/cable-standardlengths)

DeviceNet is a registered trademark of ODVA

Photographs are not to scale and do not represent detailed images of the respective products.

### ■ Accessories

- SILVYN® CHAIN
- SMART STRIP stripping tool



## UNITRONIC® BUS CAN

LAPP KABEL STUTTGART UNITRONIC® BUS CAN

## UNITRONIC® BUS CAN FD P

LAPP KABEL STUTTGART UNITRONIC® BUS CAN FD P



Info

- CAN = Controller Area Network

### Application range

#### UNITRONIC® BUS CAN

- Fixed installation
- For highly flexible applications

### Product features

#### UNITRONIC® BUS CAN

- Maximum bit rate: 1 Mbit/s for 40 m segment length
- Larger conductor cross-section is necessary with increasing length. Refer to the table below (reference values from ISO 11898).
- ISO 11898 makes recommendations for the segment length, cable cross section and bit rate

#### UNITRONIC® BUS CAN FD P

- Flame-retardant according IEC 60332-1-2
- Halogen-free outer sheath
- Maximum bit rate: 1 Mbit/s for 40 m segment length
- Larger conductor cross-section is necessary with increasing length. Refer to the table below (reference values from ISO 11898).
- ISO 11898 makes recommendations for the segment length, cable cross section and bit rate
- Flame-retardant according IEC 60332-1-2

### Norm references / Approvals

- Standardised internationally in ISO 11898
- UL/CSA type CMX (UL 444)

### Design

#### UNITRONIC® BUS CAN

- 0.22 + 0.34 + 0.5: bare stranded conductor, 7-wire
- 0.75: bare stranded conductor, fine-wire
- Colour-coded in accordance with DIN 47100
- Copper braid
- PVC sheath
- Colour: violet (RAL 4001)

#### UNITRONIC® BUS CAN FD P

- Stranded bare conductor
- Screening: wrapped with braided copper wires
- PUR outer sheath
- Colour: violet (RAL 4001)
- UV-resistant (but colour may change after some time)

### Suitable connectors

#### UNITRONIC® BUS CAN

- EPIC® Data CAN-Bus Connectors Page 80
- EPIC® Data CAN-Bus Connectors (full-metal)

### Technical data



#### Mutual capacitance

**UNITRONIC® BUS CAN**  
(800 Hz): max. 40 nF/km  
**UNITRONIC® BUS CAN FD P**  
(800 Hz): max. 60 nF/km



#### Peak operating voltage

**UNITRONIC® BUS CAN**  
(not for power applications) 250 V  
**UNITRONIC® BUS CAN FD P**  
250 V (not for power transmission)



#### Conductor resistance

**UNITRONIC® BUS CAN**  
(loop): max. 186 ohm/km  
**UNITRONIC® BUS CAN FD P**  
(loop): max. 159.8 ohm/km



#### Minimum bending radius

**UNITRONIC® BUS CAN**  
Fixed installation: 8 x outer diameter  
**UNITRONIC® BUS CAN FD P**  
Flexing: 15 x outer diameter



#### Test voltage

Core/core: 1500 V rms



#### Characteristic impedance

120 ohm



#### Temperature range

**UNITRONIC® BUS CAN**  
Fixed installation:  
-30°C to +80°C  
Flexing: -5°C to +70°C  
**UNITRONIC® BUS CAN FD P**  
Fixed installation: -40°C to +80°C  
Flexing: -30°C to +70°C

Article number	Article designation	Number of pairs/conductor cross section (mm <sup>2</sup> )	Outer diameter (mm)	Conductor resistance	Copper index (kg/km)	Weight (kg/km)
<b>for fixed installation</b>						
2170260	UNITRONIC® BUS CAN	1 x 2 x 0,22	5.7	186.0	16.7	42.0
2170261	UNITRONIC® BUS CAN	2 x 2 x 0,22	7.6	186.0	34.8	68.0
2170263	UNITRONIC® BUS CAN	1 x 2 x 0,34	6.8	115.0	25.0	55.0
2170264	UNITRONIC® BUS CAN	2 x 2 x 0,34	8.5	115.0	46.4	88.0
2170266	UNITRONIC® BUS CAN	1 x 2 x 0,5	7.5	78.0	41.6	90.0
2170267	UNITRONIC® BUS CAN	2 x 2 x 0,5	9.6	78.0	59.4	106.0
2170269	UNITRONIC® BUS CAN	1 x 2 x 0,75	8.7	52.0	52.7	108.0
2170270	UNITRONIC® BUS CAN	2 x 2 x 0,75	11.5	52.0	80.6	142.0
<b>For highly flexible applications (power chains, moving machine parts)</b>						
2170272	UNITRONIC® BUS CAN FD P	1 x 2 x 0,25	6.4	159.8	24.0	40.0
2170273	UNITRONIC® BUS CAN FD P	2 x 2 x 0,25	8.4	159.8	33.0	65.0
2170275	UNITRONIC® BUS CAN FD P	1 x 2 x 0,34	6.8	122.0	32.8	60.0
2170276	UNITRONIC® BUS CAN FD P	2 x 2 x 0,34	9.6	122.0	52.4	88.0
2170278	UNITRONIC® BUS CAN FD P	1 x 2 x 0,5	8.0	72.8	41.9	74.0
2170279	UNITRONIC® BUS CAN FD P	2 x 2 x 0,5	10.8	72.8	59.4	100.0

Unless specified otherwise, the shown product values are nominal values. Detailed values (e.g. tolerances) are available upon request.

Copper price basis: EUR 150/100kg. Refer to catalogue appendix T17 for the definition and calculation of copper-related surcharges.

Please find our standard lengths at: [www.lappkabel.de/en/cable-standardlengths](http://www.lappkabel.de/en/cable-standardlengths)

Packaging size: coil ≤ 30 kg or ≤ 250 m, otherwise drum

Please specify the preferred type of packaging (e.g. 1 x 500 m drum or 5 x 100 m coils).

Photographs are not to scale and do not represent detailed images of the respective products.

### Accessories

- Multipurpose shears A and B
- SMART STRIP stripping tool
- SENSOR STRIP stripping tool



**New**

## UNITRONIC® BUS CAN TRAY

**Info**

- CAN = Controller Area Network



### Benefits

- PLTC-ER approval for open wiring between cable tray and industrial machines/plants acc. to NEC 725.154 (D)
- No additional protection of the cable needed

### Application range

- Fixed installation

### Product features

- Maximum bit rate: 1 Mbit/s for 40 m segment length
- ISO 11898 makes recommendations for the segment length, cable cross section and bit rate
- UV-resistant UL SUN RES
- Oil-resistant according to UL OIL RES I
- Flame-retardant according to CSA FT4 UL Vertical-Tray Flame Test

### Norm references / Approvals

- Standardised internationally in ISO 11898
- C(UL)us Typ CMG (75°C) nach UL 444 / CSA 22.2
- UL Type PLTC-ER acc. to UL 13

### Design

- 7-wire bare stranded copper conductor
- Colour-coded in accordance with DIN 47100
- Copper braid
- PVC inner sheath and outer sheath
- Colour: violet (RAL 4001)

### Suitable connectors

- EPIC® Data CAN-Bus Connectors Page 80
- EPIC® Data CAN-Bus Connectors (full-metal)

### Technical data

- Mutual capacitance**  
(800 Hz): max. 40 nF/km
- Peak operating voltage**  
(not for power applications) 250 V  
Rated voltage: 600 V (UL)
- Conductor resistance**  
(loop): max. 110,8 ohm/km
- Minimum bending radius**  
Fixed installation: 8 x outer diameter  
Flexing: 15 x outer diameter
- Test voltage**  
Core/core: 2000 V
- Characteristic impedance**  
120 ohm
- Temperature range**  
Fixed installation: -40°C to +80°C  
Flexing: -10°C to +70°C

Article number	Article designation	Number of pairs/conductor cross section (mm <sup>2</sup> )	Outer diameter (mm)	Conductor resistance	Copper index (kg/km)	Weight (kg/km)
<b>UNITRONIC® BUS CAN TRAY</b>						
2170857	UNITRONIC® BUS CAN TRAY	2 x x 0,34	7,5	110,8	35,0	81,0

Unless specified otherwise, the shown product values are nominal values. Detailed values (e.g. tolerances) are available upon request.  
 Copper price basis: EUR 150/100kg. Refer to catalogue appendix T 17 for the definition and calculation of copper-related surcharges.  
 Please find our standard lengths at: [www.lappkabel.de/en/cable-standardlengths](http://www.lappkabel.de/en/cable-standardlengths)  
 Packaging size: coil ≤ 30 kg or ≤ 250 m, otherwise drum  
 Please specify the preferred type of packaging (e.g. 1 x 500 m drum or 5 x 100 m coils).  
 Photographs are not to scale and do not represent detailed images of the respective products.

### Accessories

- Multipurpose shears A and B
- SMART STRIP stripping tool





## EPIC® Data CAN-Bus Connectors

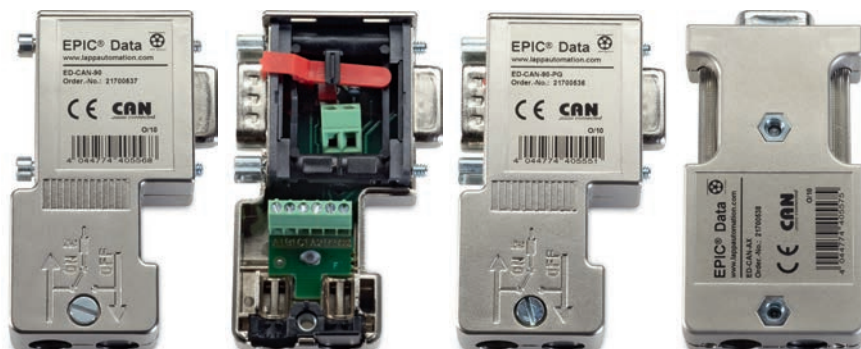

**Info**

- Fully compatible with market standard

### Benefits

- Small design
- Proven network connection
- Easy connection of bus cables by proven screw clamp connection
- Improved electromagnetic compatibility (EMC) by metallized housing
- With additional 24 V DC output to supply external devices (90° version only)

### Application range

- Automation technology
- Mechanical engineering
- Plant engineering
- Tool shop
- Control engineering

### Product features

- Screw termination
- Switchable bus termination is integrated
- The integrated, connectable terminal resistors enable the CAN-Bus to be terminated or connected through
- When used as a through connector, the switch must be in the "OFF" position. If used as a terminating connector, the switch must be in the "ON" position.
- No loose parts

### Norm references / Approvals

- D-Sub pin assignment in accordance with CiA (CAN in Automation)
- UL File: E331560

### Design

- D-Sub plug, 9-pin, fixing screws 4-40 UNC
- Metallised housing
- For cable outer diameter: 5 ... 8 mm

### Suitable cables

- Cables for bus system CAN UL/GSA-approved Page 78
- Cables for bus system DeviceNet Page 76

### Suitable tools

- Kraftform® adjustable torque screwdriver/ Kraftform Kompakt® Set

### Technical data



#### Dimensions

65 mm x 48 mm x 16 mm - 90°  
67,5 mm x 35 mm x 17 mm - 180° (LxWxH)

#### Connection type

Screwing

#### Degree of soiling

2



#### Weight

Approx. 40 g



#### Protection rating

IP20

#### Cable outlet

90° and axial

#### Terminating resistor

120 ohms integrated, and connectable with slide switch

#### Transmission rate

max. 1 MBit/s

#### Interfaces

##### CAN bus station:

D-Sub socket, 9-pin

##### CAN bus cable:

6 terminal blocks for wires up to 1.0 mm<sup>2</sup>

D-Sub pin assignment:

CAN Low = Pin 2

CAN High = Pin 7

CAN Gnd = Pin 3

GND = Pin 6 (90° version only)

CAN V+ = Pin 9 (90° version only)

(shield = housing)



#### Permissible ambient conditions

Operating temperature:

0°C to +60°C

Transport and storage temperature:

-25°C to +75°C

Relative humidity:

max. 75 % at +25°C

Article number	Article designation	Cable outlet	PG	Pieces / PU
<b>EPIC® data CAN bus connectors</b>				
21700537	ED-CAN-90	90°	no	1
21700536	ED-CAN-90-PG	90°	yes	1
21700538	ED-CAN-AX	180° axial	no	1

Unless specified otherwise, the shown product values are nominal values. Detailed values (e.g. tolerances) are available upon request.

PG = programming interface (= 2nd D-Sub)

Photographs are not to scale and do not represent detailed images of the respective products.



## S/A-cable: M12 connector/socket on free conductor end



### Benefits

- Cost-saving due to quick and easy installation
- Space-saving due to compact dimensions
- Fast and easy error tracking
- Standardised interfaces

### Application range

- Automation technology
- Mechanical engineering
- Plant engineering
- Tool shop
- Automotive industry

### Product features

- 3-pin connector
- Plug/socket with M12 thread to free conductor end
- The cables have marker carriers
- Free of paint-wetting impairment substances
- Suitable for drag chains

### Design

- Fixed flexible control cable
- Design: 3 x 0.34 mm<sup>2</sup> (42 x 0.1 mm)
- Core colours: brown(1), blue(3), black(4)
- Outer sheath: PUR, halogen-free
- Outer sheath colour: black

### Technical data

<b>IP</b>	<b>Protection rating</b> IP65/IP67/IP68
<b>0+</b>	<b>Ambient temperature (operation)</b> Plug/socket -25°C to +90°C Cable, fixed installation -40°C to +80°C Cable, flexible installation -25°C to +80°C
	<b>Contact material</b> CuSn
	<b>Contact surface material</b> Ni/Au
	<b>Coding</b> A-Standard
	<b>Knurl material</b> Zinc die-cast, nickel-plated
	<b>Gripping body material</b> TPU, flame-retardant, self-extinguishing

Article number	Article designation	Length (m)	Nominal voltage U <sub>N</sub> (V)	Nominal current I <sub>N</sub> in (A)	PU
<b>Straight connector</b>					
22260221	AB-C3-M12MS-2,0PUR	2	250	4	1
22260222	AB-C3-M12MS-5,0PUR	5	250	4	1
22260249	AB-C3-M12MS-10,0PUR	10	250	4	1
<b>Angled connector</b>					
22260223	AB-C3-M12MA-2,0PUR	2	250	4	1
22260224	AB-C3-M12MA-5,0PUR	5	250	4	1
22260256	AB-C3-M12MA-10,0PUR	10	250	4	1
<b>Straight socket</b>					
22260257	AB-C3-2,0PUR-M12FS	2	250	4	1
22260250	AB-C3-5,0PUR-M12FS	5	250	4	1
22260251	AB-C3-10,0PUR-M12FS	10	250	4	1
22260080	AB-C3-2,0PVC-M12FS	2	250	4	1
22260663	AB-C3-5,0PVC-M12FS	5	250	4	1
22260081	AB-C3-10,0PVC-M12FS	10	250	4	1
<b>Straight socket with LEDs</b>					
22260252	AB-C3-2,0PUR-M12FS-2L	2	24	4	1
22260265	AB-C3-5,0PUR-M12FS-2L	5	24	4	1
22260266	AB-C3-10,0PUR-M12FS-2L	10	24	4	1
<b>Angled socket</b>					
22260258	AB-C3-2,0PUR-M12FA	2	250	4	1
22260259	AB-C3-5,0PUR-M12FA	5	250	4	1
22260260	AB-C3-10,0PUR-M12FA	10	250	4	1
<b>Angled socket with LEDs</b>					
22260253	AB-C3-2,0PUR-M12FA-2L	2	24	4	1
22260254	AB-C3-5,0PUR-M12FA-2L	5	24	4	1
22260255	AB-C3-10,0PUR-M12FA-2L	10	24	4	1

Unless specified otherwise, the shown product values are nominal values. Detailed values (e.g. tolerances) are available upon request.

Copper price basis: inclusive of copper. Refer to catalogue appendix T17 for the definition and calculation of copper-related surcharges.

Customised cable lengths, outer-sheath materials (e.g. PVC), and types of connectors are available upon request.

Photographs are not to scale and do not represent detailed images of the respective products.

For detailed technical information please refer to the data sheet

For the UNITRONIC® field bus type code, please see table T6

UL approvals can be found in the data sheet

### Accessories

- FLEXIMARK® Label LMB



## S/A cable: M12 connector on M12 socket



### ■ Benefits

- Cost-saving due to quick and easy installation
- Space-saving due to compact dimensions
- Fast and easy error tracking
- Standardised interfaces

### ■ Application range

- Automation technology
- Mechanical engineering
- Plant engineering
- Tool shop
- Automotive industry

### ■ Product features

- 3-pin connector
- Plug with M12 thread to socket with M12 thread
- The cables have marker carriers
- Free of paint-wetting impairment substances
- Suitable for drag chains

### ■ Design

- Fixed flexible control cable
- Design: 3 x 0.34 mm<sup>2</sup> (42 x 0.1 mm)
- Core colours: brown(1), blue(3), black(4)
- Outer sheath: PUR, halogen-free
- Outer sheath colour: black

### ■ Technical data

<b>IP</b>	<b>Protection rating</b> IP65/IP67/IP68
<b>0+</b>	<b>Ambient temperature (operation)</b> Plug/socket -25°C to +90°C Cable, fixed installation -40°C to +80°C Cable, flexible installation -25°C to +80°C
	<b>Contact material</b> CuSn
	<b>Contact surface material</b> Ni/Au
	<b>Coding</b> A-Standard
	<b>Knurl material</b> Zinc die-cast, nickel-plated
	<b>Gripping body material</b> TPU, flame-retardant, self-extinguishing

Article number	Article designation	Length (m)	Nominal voltage U <sub>N</sub> (V)	Nominal current I <sub>N</sub> in (A)	Status display	PU
<b>Straight connector to straight socket</b>						
22260233	AB-C3-M12MS-0,3PUR-M12FS	0.3	250	4	no	1
22260234	AB-C3-M12MS-0,6PUR-M12FS	0.6	250	4	no	1
22260235	AB-C3-M12MS-1,0PUR-M12FS	1	250	4	no	1
22260236	AB-C3-M12MS-2,0PUR-M12FS	2	250	4	no	1
<b>Straight connector to angled socket</b>						
22260237	AB-C3-M12MS-0,3PUR-M12FA	0.3	250	4	no	1
22260238	AB-C3-M12MS-0,6PUR-M12FA	0.6	250	4	no	1
22260239	AB-C3-M12MS-1,0PUR-M12FA	1	250	4	no	1
22260240	AB-C3-M12MS-2,0PUR-M12FA	2	250	4	no	1
<b>Straight connector to angled socket with LEDs</b>						
22260261	AB-C3-M12MS-0,3PUR-M12FA-2L	0.3	24	4	2 LED	1
22260262	AB-C3-M12MS-0,6PUR-M12FA-2L	0.6	24	4	2 LED	1
22260263	AB-C3-M12MS-1,0PUR-M12FA-2L	1	24	4	2 LED	1
22260264	AB-C3-M12MS-2,0PUR-M12FA-2L	2	24	4	2 LED	1

Unless specified otherwise, the shown product values are nominal values. Detailed values (e.g. tolerances) are available upon request. Copper price basis: inclusive of copper. Refer to catalogue appendix T17 for the definition and calculation of copper-related surcharges. Customised cable lengths, outer-sheath materials (e.g. PVC), and types of connectors are available upon request. Photographs are not to scale and do not represent detailed images of the respective products. For detailed technical information please refer to the data sheet. For the UNITRONIC® field bus type code, please see table T6. UL approvals can be found in the data sheet.

### ■ Accessories

- FLEXIMARK® Label LMB



## S/A cable: M12 connector on M8 socket



### Benefits

- Cost-saving due to quick and easy installation
- Space-saving due to compact dimensions
- Fast and easy error tracking
- Standardised interfaces

### Application range

- Automation technology
- Mechanical engineering
- Plant engineering
- Tool shop
- Automotive industry

### Product features

- 3-pin connector
- Plug with M12 thread to socket with M8 thread
- The cables have marker carriers
- Free of paint-wetting impairment substances
- Suitable for drag chains

### Design

- Fixed flexible control cable
- Design: 3 x 0.25 mm<sup>2</sup> (32 x 0.1 mm)
- Core colours: brown(1), blue(3), black(4)
- Outer sheath: PUR, halogen-free
- Outer sheath colour: black

### Technical data

<b>IP</b>	<b>Protection rating</b> IP65/IP67/IP68
<b>0/1</b>	<b>Ambient temperature (operation)</b> Plug/socket -25°C to +90°C Cable, fixed installation -40°C to +80°C Cable, flexible installation -25°C to +80°C
	<b>Contact material</b> CuSn
	<b>Contact surface material</b> Ni/Au
	<b>Coding</b> A-Standard
	<b>Knurl material</b> Zinc die-cast, nickel-plated
	<b>Gripping body material</b> TPU, flame-retardant, self-extinguishing

Article number	Article designation	Length (m)	Nominal voltage U <sub>N</sub> (V)	Nominal current I <sub>N</sub> in (A)	Status display	PU
<b>Straight connector to straight socket</b>						
22260225	AB-C3-M12MS-0,3PUR-M8FS	0.3	60	3	no	1
22260226	AB-C3-M12MS-0,6PUR-M8FS	0.6	60	3	no	1
22260227	AB-C3-M12MS-1,0PUR-M8FS	1	60	3	no	1
22260228	AB-C3-M12MS-2,0PUR-M8FS	2	60	3	no	1
<b>Straight connector to angled socket</b>						
22260229	AB-C3-M12MS-0,3PUR-M8FA	0.3	60	3	no	1
22260230	AB-C3-M12MS-0,6PUR-M8FA	0.6	60	3	no	1
22260231	AB-C3-M12MS-1,0PUR-M8FA	1	60	3	no	1
22260232	AB-C3-M12MS-2,0PUR-M8FA	2	60	3	no	1
<b>Straight connector to angled socket with LEDs</b>						
22260267	AB-C3-M12MS-0,3PUR-M8FA-2L	0.3	24	3	2 LED	1
22260268	AB-C3-M12MS-0,6PUR-M8FA-2L	0.6	24	3	2 LED	1
22260269	AB-C3-M12MS-1,0PUR-M8FA-2L	1	24	3	2 LED	1
22260270	AB-C3-M12MS-2,0PUR-M8FA-2L	2	24	3	2 LED	1

Unless specified otherwise, the shown product values are nominal values. Detailed values (e.g. tolerances) are available upon request. Copper price basis: inclusive of copper. Refer to catalogue appendix T17 for the definition and calculation of copper-related surcharges. Customised cable lengths, outer-sheath materials (e.g. PVC), and types of connectors are available upon request. Photographs are not to scale and do not represent detailed images of the respective products. For detailed technical information please refer to the data sheet. For the UNITRONIC® field bus type code, please see table T6. UL approvals can be found in the data sheet.

### Accessories

- FLEXIMARK® Label LMB

**UNITRONIC® Fieldbus**

3-pin sensor/actuator cordsets



## S/A cable: M8 connector/socket on free conductor end



**Benefits**

- Cost-saving due to quick and easy installation
- Space-saving due to compact dimensions
- Fast and easy error tracking
- Standardised interfaces

**Application range**

- Automation technology
- Mechanical engineering
- Plant engineering
- Tool shop
- Automotive industry

**Product features**

- 3-pin connector
- Plug/socket with M8 thread to free conductor end
- The cables have marker carriers
- Free of paint-wetting impairment substances
- Suitable for drag chains

**Design**

- Fixed flexible control cable
- Design: 3 x 0.25 mm<sup>2</sup> (32 x 0.1 mm)
- Core colours: brown(1), blue(3), black(4)
- Outer sheath: PUR, halogen-free/PVC
- Outer sheath colour: black

**Technical data**

<b>IP</b>	<b>Protection rating</b> IP65/IP67/IP68
<b>0+</b>	<b>Ambient temperature (operation)</b> Plug/socket -25°C to +90°C (PUR/PVC) Cable, fixed installation -40°C to +80°C (PUR) -25°C to +80°C (PVC) Cable, flexible installation -25°C to +80°C (PUR/PVC)
	<b>Contact material</b> CuSn
	<b>Contact surface material</b> Ni/Au
	<b>Coding</b> A-Standard
	<b>Knurl material</b> Zinc die-cast, nickel-plated
	<b>Gripping body material</b> TPU, flame-retardant, self-extinguishing

Article number	Article designation	Length (m)	Nominal voltage U <sub>N</sub> (V)	Nominal current I <sub>n</sub> in (A)	PU
<b>Straight connector</b>					
22260204	AB-C3-M8MS-2,0PUR	2	60	3	1
22260205	AB-C3-M8MS-5,0PUR	5	60	3	1
22260218	AB-C3-M8MS-10,0PUR	10	60	3	1
22260847	AB-C3-M8MS-2,0PVC	2	60	3	1
22260665	AB-C3-M8MS-5,0PVC	5	60	3	1
22260848	AB-C3-M8MS-10,0PVC	10	60	3	1
<b>Angled connector</b>					
22260053	AB-C3-M8MA-2,0PUR	2	60	3	1
22260987	AB-C3-M8MA-5,0PUR	5	60	3	1
22260055	AB-C3-M8MA-10,0PUR	10	60	3	1
<b>Straight socket</b>					
22260202	AB-C3-2,0PUR-M8FS	2	60	3	1
22260200	AB-C3-5,0PUR-M8FS	5	60	3	1
22260219	AB-C3-10,0PUR-M8FS	10	60	3	1
<b>Angled socket</b>					
22260203	AB-C3-2,0PUR-M8FA	2	60	3	1
22260201	AB-C3-5,0PUR-M8FA	5	60	3	1
22260220	AB-C3-10,0PUR-M8FA	10	60	3	1
<b>Angled socket with LEDs</b>					
22260275	AB-C3-2,0PUR-M8FA-2L	2	24	3	1
22260276	AB-C3-5,0PUR-M8FA-2L	5	24	3	1
22260277	AB-C3-10,0PUR-M8FA-2L	10	24	3	1

Unless specified otherwise, the shown product values are nominal values. Detailed values (e.g. tolerances) are available upon request. Copper price basis: inclusive of copper. Refer to catalogue appendix T17 for the definition and calculation of copper-related surcharges. Customised cable lengths, outer-sheath materials (e.g. PVC), and types of connectors are available upon request. Photographs are not to scale and do not represent detailed images of the respective products. For detailed technical information please refer to the data sheet. UL approvals can be found in the data sheet. For the UNITRONIC® field bus type code, please see table T6.

**Accessories**

- FLEXIMARK® Label LMB





## S/A cable: M8 connector on M8 socket



### Benefits

- Cost-saving due to quick and easy installation
- Space-saving due to compact dimensions
- Fast and easy error tracking
- Standardised interfaces

### Application range

- Automation technology
- Mechanical engineering
- Plant engineering
- Tool shop
- Automotive industry

### Product features

- 3-pin connector
- Plug with M8 thread to socket with M8 thread
- The cables have marker carriers
- Free of paint-wetting impairment substances
- Suitable for drag chains

### Design

- Fixed flexible control cable
- Design: 3 x 0.25 mm<sup>2</sup> (32 x 0.1 mm)
- Core colours: brown(1), blue(3), black(4)
- Outer sheath: PUR, halogen-free
- Outer sheath colour: black

### Technical data

<b>IP</b>	<b>Protection rating</b> IP65/IP67/IP68
<b>0/1</b>	<b>Ambient temperature (operation)</b> Plug/socket -25°C to +90°C Cable, fixed installation -40°C to +80°C Cable, flexible installation -25°C to +80°C
	<b>Contact material</b> CuSn
	<b>Contact surface material</b> Ni/Au
	<b>Coding</b> A-Standard
	<b>Knurl material</b> Zinc die-cast, nickel-plated
	<b>Gripping body material</b> TPU, flame-retardant, self-extinguishing

Article number	Article designation	Length (m)	Nominal voltage U <sub>N</sub> (V)	Nominal current I <sub>N</sub> in (A)	Status display	PU
<b>Straight connector to straight socket</b>						
22260206	AB-C3-M8MS-0,3PUR-M8FS	0.3	60	3	no	1
22260207	AB-C3-M8MS-0,6PUR-M8FS	0.6	60	3	no	1
22260208	AB-C3-M8MS-1,0PUR-M8FS	1	60	3	no	1
22260209	AB-C3-M8MS-2,0PUR-M8FS	2	60	3	no	1
<b>Straight connector to angled socket</b>						
22260210	AB-C3-M8MS-0,3PUR-M8FA	0.3	60	3	no	1
22260211	AB-C3-M8MS-0,6PUR-M8FA	0.6	60	3	no	1
22260212	AB-C3-M8MS-1,0PUR-M8FA	1	60	3	no	1
22260213	AB-C3-M8MS-2,0PUR-M8FA	2	60	3	no	1
<b>Straight connector to angled socket with LEDs</b>						
22260214	AB-C3-M8MS-0,3PUR-M8FA-2L	0.3	24	3	2 LED	1
22260215	AB-C3-M8MS-0,6PUR-M8FA-2L	0.6	24	3	2 LED	1
22260216	AB-C3-M8MS-1,0PUR-M8FA-2L	1	24	3	2 LED	1
22260217	AB-C3-M8MS-2,0PUR-M8FA-2L	2	24	3	2 LED	1

Unless specified otherwise, the shown product values are nominal values. Detailed values (e.g. tolerances) are available upon request.  
 Copper price basis: inclusive of copper. Refer to catalogue appendix T17 for the definition and calculation of copper-related surcharges.  
 Customised cable lengths, outer-sheath materials (e.g. PVC), and types of connectors are available upon request.  
 Photographs are not to scale and do not represent detailed images of the respective products.  
 For detailed technical information please refer to the data sheet  
 For the UNITRONIC® field bus type code, please see table T6  
 UL approvals can be found in the data sheet

### Accessories

- FLEXIMARK® Label LMB



## S/A cable: M8 connector on M12 socket



### Benefits

- Cost-saving due to quick and easy installation
- Space-saving due to compact dimensions
- Fast and easy error tracking
- Standardised interfaces

### Application range

- Automation technology
- Mechanical engineering
- Plant engineering
- Tool shop
- Automotive industry

### Product features

- 3-pin connector
- Plug with M8 thread to socket with M12 thread
- The cables have marker carriers
- Free of paint-wetting impairment substances
- Suitable for drag chains

### Design

- Fixed flexible control cable
- Design: 3 x 0.25 mm<sup>2</sup> (32 x 0.1 mm)
- Core colours: brown(1), blue(3), black(4)
- Outer sheath: PUR, halogen-free
- Outer sheath colour: black

### Technical data

<b>IP</b>	<b>Protection rating</b> IP65/IP67/IP68
<b>0+</b>	<b>Ambient temperature (operation)</b> Plug/socket -25°C to +90°C Cable, fixed installation -40°C to +80°C Cable, flexible installation -25°C to +80°C
	<b>Contact material</b> CuSn
	<b>Contact surface material</b> Ni/Au
	<b>Coding</b> A-Standard
	<b>Knurl material</b> Zinc die-cast, nickel-plated
	<b>Gripping body material</b> TPU, flame-retardant, self-extinguishing

Article number	Article designation	Length (m)	Nominal voltage U <sub>N</sub> (V)	Nominal current I <sub>N</sub> in (A)	Status display	PU
<b>Straight connector to straight socket</b>						
22260241	AB-C3-M8MS-0,3PUR-M12FS	0.3	60	3	no	1
22260242	AB-C3-M8MS-0,6PUR-M12FS	0.6	60	3	no	1
22260243	AB-C3-M8MS-1,0PUR-M12FS	1	60	3	no	1
22260244	AB-C3-M8MS-2,0PUR-M12FS	2	60	3	no	1
<b>Straight connector to angled socket</b>						
22260245	AB-C3-M8MS-0,3PUR-M12FA	0.3	60	3	no	1
22260246	AB-C3-M8MS-0,6PUR-M12FA	0.6	60	3	no	1
22260247	AB-C3-M8MS-1,0PUR-M12FA	1	60	3	no	1
22260248	AB-C3-M8MS-2,0PUR-M12FA	2	60	3	no	1
<b>Straight connector to angled socket with LEDs</b>						
22260271	AB-C3-M8MS-0,3PUR-M12FA-2L	0.3	24	3	2 LED	1
22260272	AB-C3-M8MS-0,6PUR-M12FA-2L	0.6	24	3	2 LED	1
22260273	AB-C3-M8MS-1,0PUR-M12FA-2L	1	24	3	2 LED	1
22260274	AB-C3-M8MS-2,0PUR-M12FA-2L	2	24	3	2 LED	1

Unless specified otherwise, the shown product values are nominal values. Detailed values (e.g. tolerances) are available upon request. Copper price basis: inclusive of copper. Refer to catalogue appendix T17 for the definition and calculation of copper-related surcharges. Customised cable lengths, outer-sheath materials (e.g. PVC), and types of connectors are available upon request. Photographs are not to scale and do not represent detailed images of the respective products. For detailed technical information please refer to the data sheet. For the UNITRONIC® field bus type code, please see table T6. UL approvals can be found in the data sheet.

### Accessories

- FLEXIMARK® Label LMB



## S/A cable: M12 connector/socket on free conductor end



### Benefits

- Cost-saving due to quick and easy installation
- Space-saving due to compact dimensions
- Fast and easy error tracking
- Standardised interfaces

### Application range

- Automation technology
- Mechanical engineering
- Plant engineering
- Tool shop
- Automotive industry

### Product features

- 4-pin connector
- Plug/socket with M12 thread to free conductor end
- The cables have marker carriers
- Free of paint-wetting impairment substances
- Suitable for drag chains

### Design

- Fixed flexible control cable
- Design: 4 x 0.34 mm<sup>2</sup> (42 x 0.1 mm)
- Core colours: brown(1), white(2), blue(3), black(4)
- Outer sheath: PUR, halogen-free
- Outer sheath colour: black

### Technical data

<b>IP</b>	<b>Protection rating</b> IP65/IP67/IP68
<b>0+T</b>	<b>Ambient temperature (operation)</b> Plug/socket -25°C to +90°C Cable, fixed installation -40°C to +80°C Cable, flexible installation -25°C to +80°C
	<b>Contact material</b> CuSn
	<b>Contact surface material</b> Ni/Au
	<b>Coding</b> A-Standard
	<b>Knurl material</b> Zinc die-cast, nickel-plated
	<b>Gripping body material</b> TPU, flame-retardant, self-extinguishing

Article number	Article designation	Length (m)	Nominal voltage U <sub>N</sub> (V)	Nominal current I <sub>N</sub> in (A)	PU
<b>Straight connector</b>					
22260320	AB-C4-M12MS-2,0PUR	2	250	4	1
22260321	AB-C4-M12MS-5,0PUR	5	250	4	1
22260342	AB-C4-M12MS-10,0PUR	10	250	4	1
<b>Angled connector</b>					
22260301	AB-C4-M12MA-2,0PUR	2	250	4	1
22260302	AB-C4-M12MA-5,0PUR	5	250	4	1
22260303	AB-C4-M12MA-10,0PUR	10	250	4	1
<b>Straight socket</b>					
22260322	AB-C4-2,0PUR-M12FS	2	250	4	1
22260323	AB-C4-5,0PUR-M12FS	5	250	4	1
22260343	AB-C4-10,0PUR-M12FS	10	250	4	1
22260688	AB-C4-2,0PVC-M12FS	2	250	4	1
22260689	AB-C4-5,0PVC-M12FS	5	250	4	1
22260685	AB-C4-10,0PVC-M12FS	10	250	4	1
<b>Straight socket with LEDs</b>					
22260344	AB-C4-2,0PUR-M12FS-2L	2	24	4	1
22260345	AB-C4-5,0PUR-M12FS-2L	5	24	4	1
22260346	AB-C4-10,0PUR-M12FS-2L	10	24	4	1
<b>Angled socket</b>					
22260324	AB-C4-2,0PUR-M12FA	2	250	4	1
22260325	AB-C4-5,0PUR-M12FA	5	250	4	1
22260341	AB-C4-10,0PUR-M12FA	10	250	4	1
22260841	AB-C4-2,0PVC-M12FA	2	250	4	1
22260678	AB-C4-5,0PVC-M12FA	5	250	4	1
22260683	AB-C4-10,0PVC-M12FA	10	250	4	1
<b>Angled socket with LEDs</b>					
22260326	AB-C4-2,0PUR-M12FA-3L	2	24	4	1
22260327	AB-C4-5,0PUR-M12FA-3L	5	24	4	1
22260340	AB-C4-10,0PUR-M12FA-3L	10	24	4	1

Unless specified otherwise, the shown product values are nominal values. Detailed values (e.g. tolerances) are available upon request.  
 Copper price basis: inclusive of copper. Refer to catalogue appendix T17 for the definition and calculation of copper-related surcharges.  
 Customised cable lengths, outer-sheath materials (e.g. PVC), and types of connectors are available upon request.  
 Photographs are not to scale and do not represent detailed images of the respective products.  
 For detailed technical information please refer to the data sheet  
 For the UNITRONIC® field bus type code, please see table T6  
 UL approvals can be found in the data sheet

### Accessories

- FLEXIMARK® Label LMB



## S/A cable: M12 connector on M12 socket



### Benefits

- Cost-saving due to quick and easy installation
- Space-saving due to compact dimensions
- Fast and easy error tracking
- Standardised interfaces

### Application range

- Automation technology
- Mechanical engineering
- Plant engineering
- Tool shop
- Automotive industry

### Product features

- 4-pin connector
- Plug with M12 thread to socket with M12 thread
- The cables have marker carriers
- Free of paint-wetting impairment substances
- Suitable for drag chains

### Design

- Fixed flexible control cable
- Design: 4 x 0.34 mm<sup>2</sup> (42 x 0.1 mm)
- Core colours: brown(1), white(2), blue(3), black(4)
- Outer sheath: PUR, halogen-free/PVC
- Outer sheath colour: black

### Technical data

<b>IP</b>	<b>Protection rating</b> IP65/IP67/IP68
<b>0+</b>	<b>Ambient temperature (operation)</b> Plug/socket -25°C to +90°C (PUR/PVC) Cable, fixed installation -40°C to +80°C (PUR) -25°C to +80°C (PVC) Cable, flexible installation -25°C to +80°C (PUR/PVC)
	<b>Contact material</b> CuSn
	<b>Contact surface material</b> Ni/Au
	<b>Coding</b> A-Standard
	<b>Knurl material</b> Zinc die-cast, nickel-plated
	<b>Gripping body material</b> TPU, flame-retardant, self-extinguishing

Article number	Article designation	Length (m)	Nominal voltage U <sub>N</sub> (V)	Nominal current I <sub>N</sub> in (A)	Status display	PU
<b>Straight connector to straight socket</b>						
22260328	AB-C4-M12MS- 0,3PUR-M12FS	0.3	250	4	no	1
22260329	AB-C4-M12MS- 0,6PUR-M12FS	0.6	250	4	no	1
22260330	AB-C4-M12MS- 1,0PUR-M12FS	1	250	4	no	1
22260331	AB-C4-M12MS- 2,0PUR-M12FS	2	250	4	no	1
<b>Straight connector to angled socket</b>						
22260332	AB-C4-M12MS- 0,3PUR-M12FA	0.3	250	4	no	1
22260333	AB-C4-M12MS- 0,6PUR-M12FA	0.6	250	4	no	1
22260334	AB-C4-M12MS-1,0PUR-M12FA	1	250	4	no	1
22260335	AB-C4-M12MS-2,0PUR-M12FA	2	250	4	no	1
22260832	AB-C4-M12MS-2,0PVC-M12FA	2	250	4	no	1
22260705	AB-C4-M12MS-5,0PVC-M12FA	5	250	4	no	1
22260833	AB-C4-M12MS-10,0PVC-M12FA	10	250	4	no	1
<b>Angled connector to straight socket</b>						
22260304	AB-C4-M12MA-0,3PUR-M12FS	0.3	250	4	no	1
22260305	AB-C4-M12MA-0,6PUR-M12FS	0.6	250	4	no	1
22260306	AB-C4-M12MA-1,0PUR-M12FS	1	250	4	no	1
22260307	AB-C4-M12MA-2,0PUR-M12FS	2	250	4	no	1
<b>Straight connector to angled socket with LEDs</b>						
22260336	AB-C4-M12MS-0,3PUR-M12FA-3L	0.3	24	4	3 LEDs	1
22260337	AB-C4-M12MS-0,6PUR-M12FA-3L	0.6	24	4	3 LEDs	1
22260338	AB-C4-M12MS-1,0PUR-M12FA-3L	1	24	4	3 LEDs	1
22260339	AB-C4-M12MS-2,0PUR-M12FA-3L	2	24	4	3 LEDs	1

Unless specified otherwise, the shown product values are nominal values. Detailed values (e.g. tolerances) are available upon request.  
 Copper price basis: inclusive of copper. Refer to catalogue appendix T17 for the definition and calculation of copper-related surcharges.  
 Customised cable lengths, outer-sheath materials (e.g. PVC), and types of connectors are available upon request.  
 Photographs are not to scale and do not represent detailed images of the respective products.  
 For detailed technical information please refer to the data sheet  
 UL approvals can be found in the data sheet  
 For the UNITRONIC® field bus type code, please see table T6

### Accessories

- FLEXIMARK® Label LMB



## S/A cable: M12 connector on M8 socket



### Benefits

- Cost-saving due to quick and easy installation
- Space-saving due to compact dimensions
- Fast and easy error tracking
- Standardised interfaces

### Application range

- Automation technology
- Mechanical engineering
- Plant engineering
- Tool shop
- Automotive industry

### Product features

- 4-pin connector
- Plug with M12 thread to socket with M8 thread
- The cables have marker carriers
- Free of paint-wetting impairment substances
- Suitable for drag chains

### Design

- Fixed flexible control cable
- Design: 4 x 0.25 mm<sup>2</sup> (32 x 0.1 mm)
- Core colours: brown(1), white(2), blue(3), black(4)
- Outer sheath: PUR, halogen-free
- Outer sheath colour: black

### Technical data

<b>IP</b>	<b>Protection rating</b> IP65/IP67/IP68
<b>0/ff</b>	<b>Ambient temperature (operation)</b> Plug/socket -25°C to +90°C Cable, fixed installation -40°C to +80°C Cable, flexible installation -25°C to +80°C
	<b>Contact material</b> CuSn
	<b>Contact surface material</b> Ni/Au
	<b>Coding</b> A-Standard
	<b>Knurl material</b> Zinc die-cast, nickel-plated
	<b>Gripping body material</b> TPU, flame-retardant, self-extinguishing

Article number	Article designation	Length (m)	Nominal voltage U <sub>N</sub> (V)	Nominal current I <sub>N</sub> in (A)	Status display	PU
<b>Straight connector to straight socket</b>						
22260347	AB-C4-M12MS-0,3PUR-M8FS	0,3	30	3	no	1
22260349	AB-C4-M12MS-0,6PUR-M8FS	0,6	30	3	no	1
22260350	AB-C4-M12MS-1,0PUR-M8FS	1	30	3	no	1
22260348	AB-C4-M12MS-2,0PUR-M8FS	2	30	3	no	1

Unless specified otherwise, the shown product values are nominal values. Detailed values (e.g. tolerances) are available upon request.  
 Copper price basis: inclusive of copper. Refer to catalogue appendix T 17 for the definition and calculation of copper-related surcharges.  
 Customised cable lengths, outer-sheath materials (e.g. PVC), and types of connectors are available upon request.  
 Photographs are not to scale and do not represent detailed images of the respective products.  
 For detailed technical information please refer to the data sheet  
 UL approvals can be found in the data sheet  
 For the UNITRONIC® field bus type code, please see table T6

### Accessories

- FLEXIMARK® Label LMB





## S/A cable: M8 connector/socket on free conductor end



### ■ Benefits

- Cost-saving due to quick and easy installation
- Space-saving due to compact dimensions
- Fast and easy error tracking
- Standardised interfaces

### ■ Application range

- Automation technology
- Mechanical engineering
- Plant engineering
- Tool shop
- Automotive industry

### ■ Product features

- 4-pin connector
- Plug/socket with M8 thread to free conductor end
- The cables have marker carriers
- Free of paint-wetting impairment substances
- Suitable for drag chains

### ■ Design

- Fixed flexible control cable
- Design: 4 x 0.25 mm<sup>2</sup> (32 x 0.1 mm)
- Core colours: brown(1), white(2), blue(3), black(4)
- Outer sheath: PUR, halogen-free
- Outer sheath colour: black

### ■ Technical data

<b>IP</b>	<b>Protection rating</b> IP65/IP67/IP68
<b>0+</b>	<b>Ambient temperature (operation)</b> Plug/socket -25°C to +90°C Cable, fixed installation -40°C to +80°C Cable, flexible installation -25°C to +80°C
	<b>Contact material</b> CuSn
	<b>Contact surface material</b> Ni/Au
	<b>Coding</b> A-Standard
	<b>Knurl material</b> Zinc die-cast, nickel-plated
	<b>Gripping body material</b> TPU, flame-retardant, self-extinguishing

Article number	Article designation	Length (m)	Nominal voltage U <sub>N</sub> (V)	Nominal current I <sub>N</sub> in (A)	PU
<b>Straight connector</b>					
22260300	AB-C4-M8MS-2,0PUR	2	30	3	1
22260308	AB-C4-M8MS-5,0PUR	5	30	3	1
22260318	AB-C4-M8MS-10,0PUR	10	30	3	1
<b>Angled connector</b>					
22260056	AB-C4-M8MA-2,0PUR	2	30	3	1
22260057	AB-C4-M8MA-5,0PUR	5	30	3	1
22260058	AB-C4-M8MA-10,0PUR	10	30	3	1
<b>Straight socket</b>					
22260309	AB-C4- 2,0PUR-M8FS	2	30	3	1
22260310	AB-C4- 5,0PUR-M8FS	5	30	3	1
22260317	AB-C4-10,0PUR-M8FS	10	30	3	1
<b>Angled socket</b>					
22260311	AB-C4- 2,0PUR-M8FA	2	30	3	1
22260312	AB-C4- 5,0PUR-M8FA	5	30	3	1
22260319	AB-C4-10,0PUR-M8FA	10	30	3	1

Unless specified otherwise, the shown product values are nominal values. Detailed values (e.g. tolerances) are available upon request.  
 Copper price basis: inclusive of copper. Refer to catalogue appendix T17 for the definition and calculation of copper-related surcharges.  
 Customised cable lengths, outer-sheath materials (e.g. PVC), and types of connectors are available upon request.  
 Photographs are not to scale and do not represent detailed images of the respective products.  
 For detailed technical information please refer to the data sheet  
 UL approvals can be found in the data sheet  
 For the UNITRONIC® field bus type code, please see table T6

### ■ Accessories

- FLEXIMARK® Label LMB



## S/A cable: M8 connector on M8 socket



### Benefits

- Cost-saving due to quick and easy installation
- Space-saving due to compact dimensions
- Fast and easy error tracking
- Standardised interfaces

### Application range

- Automation technology
- Mechanical engineering
- Plant engineering
- Tool shop
- Automotive industry

### Product features

- 4-pin connector
- Plug with M8 thread to socket with M8 thread
- The cables have marker carriers
- Free of paint-wetting impairment substances
- Suitable for drag chains

### Design

- Fixed flexible control cable
- Design: 4 x 0.25 mm<sup>2</sup> (32 x 0.1 mm)
- Core colours: brown(1), white(2), blue(3), black(4)
- Outer sheath: PUR, halogen-free
- Outer sheath colour: black

### Technical data

<b>IP</b>	<b>Protection rating</b> IP65/IP67/IP68
<b>0/1</b>	<b>Ambient temperature (operation)</b> Plug/socket -25°C to +90°C Cable, fixed installation -40°C to +80°C Cable, flexible installation -25°C to +80°C
	<b>Contact material</b> CuSn
	<b>Contact surface material</b> Ni/Au
	<b>Coding</b> A-Standard
	<b>Knurl material</b> Zinc die-cast, nickel-plated
	<b>Gripping body material</b> TPU, flame-retardant, self-extinguishing

Article number	Article designation	Length (m)	Nominal voltage U <sub>N</sub> (V)	Nominal current I <sub>N</sub> in (A)	Status display	PU
<b>Straight connector to straight socket</b>						
22260313	AB-C4-M8MS-0,3PUR-M8FS	0.3	30	3	no	1
22260314	AB-C4-M8MS-0,6PUR-M8FS	0.6	30	3	no	1
22260315	AB-C4-M8MS-1,0PUR-M8FS	1	30	3	no	1
22260316	AB-C4-M8MS-2,0PUR-M8FS	2	30	3	no	1
<b>Straight connector to angled socket</b>						
22260059	AB-C4-M8MS-0,3PUR-M8FA	0.3	30	3	no	1
22260060	AB-C4-M8MS-0,6PUR-M8FA	0.6	30	3	no	1
22260061	AB-C4-M8MS-1,0PUR-M8FA	1	30	3	no	1
22260062	AB-C4-M8MS-2,0PUR-M8FA	2	30	3	no	1

Unless specified otherwise, the shown product values are nominal values. Detailed values (e.g. tolerances) are available upon request.

Copper price basis: inclusive of copper. Refer to catalogue appendix T17 for the definition and calculation of copper-related surcharges.

Customised cable lengths, outer-sheath materials (e.g. PVC), and types of connectors are available upon request.

Photographs are not to scale and do not represent detailed images of the respective products.

For detailed technical information please refer to the data sheet

UL approvals can be found in the data sheet

For the UNITRONIC® field bus type code, please see table T6

### Accessories

- FLEXIMARK® Label LMB



## S/A cable: M12 connector/socket on free conductor end



### Benefits

- Cost-saving due to quick and easy installation
- Space-saving due to compact dimensions
- Fast and easy error tracking
- Standardised interfaces

### Application range

- Automation technology
- Mechanical engineering
- Plant engineering
- Tool shop
- Automotive industry

### Product features

- 5-pin connector
- Plug/socket with M12 thread to free conductor end
- The cables have marker carriers
- Free of paint-wetting impairment substances
- Suitable for drag chains

### Design

- Fixed flexible control cable
- Design: 5 x 0.34 mm<sup>2</sup> (42 x 0.1 mm)
- Core colours: brown(1), white(2), blue(3), black(4), green/yellow(5)
- Outer sheath: PUR, halogen-free
- Outer sheath colour: black

### Technical data

<b>IP</b>	<b>Protection rating</b> IP65/IP67/IP68
<b>0+</b>	<b>Ambient temperature (operation)</b> Plug/socket -25°C to +90°C Cable, fixed installation -40°C to +80°C Cable, flexible installation -25°C to +80°C
	<b>Contact material</b> CuSn
	<b>Contact surface material</b> Ni/Au
	<b>Coding</b> A-Standard
	<b>Knurl material</b> Zinc die-cast, nickel-plated
	<b>Gripping body material</b> TPU, flame-retardant, self-extinguishing

Article number	Article designation	Length (m)	Nominal voltage U <sub>N</sub> (V)	Nominal current I <sub>N</sub> in (A)	PU
<b>Straight connector</b>					
22260400	AB-C5-M12MS-2,0PUR	2	60	4	1
22260401	AB-C5-M12MS-5,0PUR	5	60	4	1
22260414	AB-C5-M12MS-10,0PUR	10	60	4	1
<b>Angled connector</b>					
22260402	AB-C5-M12MA-2,0PUR	2	60	4	1
22260403	AB-C5-M12MA-5,0PUR	5	60	4	1
22260417	AB-C5-M12MA-10,0PUR	10	60	4	1
<b>Straight socket</b>					
22260404	AB-C5- 2,0PUR-M12FS	2	60	4	1
22260405	AB-C5- 5,0PUR-M12FS	5	60	4	1
22260415	AB-C5-10,0PUR-M12FS	10	60	4	1
<b>Angled socket</b>					
22260406	AB-C5- 2,0PUR-M12FA	2	60	4	1
22260407	AB-C5- 5,0PUR-M12FA	5	60	4	1
22260418	AB-C5-10,0PUR-M12FA	10	60	4	1
<b>Angled socket with LEDs</b>					
22260408	AB-C5- 2,0PUR-M12FA-3L	2	24	4	1
22260409	AB-C5- 5,0PUR-M12FA-3L	5	24	4	1
22260416	AB-C5-10,0PUR-M12FA-3L	10	24	4	1
22260760	AB-C5-25,0PUR-M12FA-3L	25	24	4	1

Unless specified otherwise, the shown product values are nominal values. Detailed values (e.g. tolerances) are available upon request.  
 Copper price basis: inclusive of copper. Refer to catalogue appendix T17 for the definition and calculation of copper-related surcharges.  
 Customised cable lengths, outer-sheath materials (e.g. PVC), and types of connectors are available upon request.  
 Photographs are not to scale and do not represent detailed images of the respective products.  
 For detailed technical information please refer to the data sheet  
 For the UNITRONIC® field bus type code, please see table T6  
 UL approvals can be found in the data sheet

### Accessories

- FLEXIMARK® Label LMB



## S/A cable: M 12 connector on M 12 socket



### Benefits

- Cost-saving due to quick and easy installation
- Space-saving due to compact dimensions
- Fast and easy error tracking
- Standardised interfaces

### Application range

- Automation technology
- Mechanical engineering
- Plant engineering
- Tool shop
- Automotive industry

### Product features

- 5-pin connector
- Plug with M 12 thread to socket with M 12 thread
- The cables have marker carriers
- Free of paint-wetting impairment substances
- Suitable for drag chains

### Design

- Fixed flexible control cable
- Design: 5 x 0.34 mm<sup>2</sup> (42 x 0.1 mm)
- Core colours: brown(1), white(2), blue(3), black(4), green/yellow(5)
- Outer sheath: PUR, halogen-free
- Outer sheath colour: black

### Technical data

<b>IP</b>	<b>Protection rating</b> IP65/IP67/IP68
<b>0/f</b>	<b>Ambient temperature (operation)</b> Plug/socket -25°C to +90°C Cable, fixed installation -40°C to +80°C Cable, flexible installation -25°C to +80°C
	<b>Contact material</b> CuSn
	<b>Contact surface material</b> Ni/Au
	<b>Coding</b> A-Standard
	<b>Knurl material</b> Zinc die-cast, nickel-plated
	<b>Gripping body material</b> TPU, flame-retardant, self-extinguishing

Article number	Article designation	Length (m)	Nominal voltage U <sub>N</sub> (V)	Nominal current I <sub>N</sub> in (A)	Status display	PU
<b>Straight connector to straight socket</b>						
22260410	AB-C5-M 12MS-0,3PUR-M 12FS	0.3	60	4	no	1
22260411	AB-C5-M 12MS-0,6PUR-M 12FS	0.6	60	4	no	1
22260412	AB-C5-M 12MS-1,0PUR-M 12FS	1	60	4	no	1
22260413	AB-C5-M 12MS-2,0PUR-M 12FS	2	60	4	no	1
<b>Straight connector to angled socket</b>						
22260063	AB-C5-M 12MS-0,3PUR-M 12FA	0.3	60	4	no	1
22260064	AB-C5-M 12MS-0,6PUR-M 12FA	0.6	60	4	no	1
22260065	AB-C5-M 12MS-1,0PUR-M 12FA	1	60	4	no	1
22260066	AB-C5-M 12MS-2,0PUR-M 12FA	2	60	4	no	1
<b>Straight connector to angled socket with LEDs</b>						
22260067	AB-C5-M 12MS-0,3PUR-M 12FA-3L	0.3	24	4	3 LEDs	1
22260068	AB-C5-M 12MS-0,6PUR-M 12FA-3L	0.6	24	4	3 LEDs	1
22260069	AB-C5-M 12MS-1,0PUR-M 12FA-3L	1	24	4	3 LEDs	1
22260070	AB-C5-M 12MS-2,0PUR-M 12FA-3L	2	24	4	3 LEDs	1

Unless specified otherwise, the shown product values are nominal values. Detailed values (e.g. tolerances) are available upon request.  
 Copper price basis: inclusive of copper. Refer to catalogue appendix T17 for the definition and calculation of copper-related surcharges.  
 Customised cable lengths, outer-sheath materials (e.g. PVC), and types of connectors are available upon request.  
 Photographs are not to scale and do not represent detailed images of the respective products.  
 For detailed technical information please refer to the data sheet  
 UL approvals can be found in the data sheet  
 For the UNITRONIC® field bus type code, please see table T6

### Accessories

- FLEXIMARK® Label LMB



## S/A cable: M12 connector/socket on free conductor end



### Benefits

- Cost-saving due to quick and easy installation
- Space-saving due to compact dimensions
- Fast and easy error tracking
- Standardised interfaces

### Application range

- Automation technology
- Mechanical engineering
- Plant engineering
- Tool shop
- Automotive industry

### Product features

- 8-pin connector
- Design: plug/socket with M12 thread to free conductor end
- The cables have marker carriers
- Free of paint-wetting impairment substances
- Suitable for drag chains

### Design

- Fixed flexible control cable
- Design: 8 x 0.25 mm<sup>2</sup> (32 x 0.1 mm)
- Core colours: white(1), brown(2), green(3), yellow(4), grey(5), pink(6), blue(7), red(8)
- Outer sheath: PUR, halogen-free
- Outer sheath colour: black

### Technical data

<b>IP</b>	<b>Protection rating</b> IP65/IP67/IP68
<b>0+</b>	<b>Ambient temperature (operation)</b> Plug/socket -25°C to +90°C Cable, fixed installation -40°C to +80°C Cable, flexible installation -25°C to +80°C
	<b>Contact material</b> CuSn
	<b>Contact surface material</b> Ni/Au
	<b>Coding</b> A-Standard
	<b>Knurl material</b> Zinc die-cast, nickel-plated
	<b>Gripping body material</b> TPU, flame-retardant, self-extinguishing

Article number	Article designation	Length (m)	Nominal voltage U <sub>N</sub> (V)	Nominal current I <sub>N</sub> in (A)	PU
<b>Straight connector</b>					
22260091	AB-C8-M12MS-2,0PUR	2	30	2	1
22260092	AB-C8-M12MS-5,0PUR	5	30	2	1
22260093	AB-C8-M12MS-10,0PUR	10	30	2	1
<b>Angled connector</b>					
22260094	AB-C8-M12MA-2,0PUR	2	30	2	1
22260095	AB-C8-M12MA-5,0PUR	5	30	2	1
22260096	AB-C8-M12MA-10,0PUR	10	30	2	1
<b>Straight socket</b>					
22260726	AB-C8-2,0PUR-M12FS	2	30	2	1
22260728	AB-C8-5,0PUR-M12FS	5	30	2	1
22260729	AB-C8-10,0PUR-M12FS	10	30	2	1
<b>Angled socket</b>					
22260141	AB-C8-2,0PUR-M12FA	2	30	2	1
<b>8 pole angled socket</b>					
22260615	AB-C8-5,0PUR-M12FA	5	30	2	1
22260616	AB-C8-10,0PUR-M12FA	10	30	2	1

Unless specified otherwise, the shown product values are nominal values. Detailed values (e.g. tolerances) are available upon request. Customised cable lengths, outer-sheath materials (e.g. PVC), and types of connectors are available upon request. Photographs are not to scale and do not represent detailed images of the respective products. For detailed technical information please refer to the data sheet. For the UNITRONIC® field bus type code, please see table T6. UL approvals can be found in the data sheet.

### Accessories

- FLEXIMARK® Label LMB





## S/A cable: M 12 connector on M 12 socket



### Benefits

- Cost-saving due to quick and easy installation
- Space-saving due to compact dimensions
- Fast and easy error tracking
- Standardised interfaces

### Application range

- Automation technology
- Mechanical engineering
- Plant engineering
- Tool shop
- Automotive industry

### Product features

- 8-pin connector
- Plug with M 12 thread to socket with M 12 thread
- The cables have marker carriers
- Free of paint-wetting impairment substances
- Suitable for drag chains

### Design

- Fixed flexible control cable
- Design: 8 x 0.25 mm<sup>2</sup> (32 x 0.1 mm)
- Core colours: white(1), brown(2), green(3), yellow(4), grey(5), pink(6), blue(7), red(8)
- Outer sheath: PUR, halogen-free
- Outer sheath colour: black

### Technical data

<b>IP</b>	<b>Protection rating</b> IP65/IP67/IP68
<b>0/f</b>	<b>Ambient temperature (operation)</b> Plug/socket -25°C to +90°C Cable, fixed installation -40°C to +90°C Cable, flexible installation -5°C to 80°C
	<b>Contact material</b> CuSn
	<b>Contact surface material</b> Ni/Au
	<b>Coding</b> A-Standard
	<b>Knurl material</b> Zinc die-cast, nickel-plated
	<b>Gripping body material</b> TPU, flame-retardant, self-extinguishing

Article number	Article designation	Length (m)	Nominal voltage U <sub>N</sub> (V)	Nominal current I <sub>N</sub> in (A)	PU
<b>Straight connector to straight socket</b>					
22260097	AB-C8-M12MS-0,3PUR-M12FS	0.3	30	2	1
22260098	AB-C8-M12MS-0,6PUR-M12FS	0.6	30	2	1
22260099	AB-C8-M12MS-1,0PUR-M12FS	1	30	2	1
22260042	AB-C8-M12MS-2,0PUR-M12FS	2	30	2	1
<b>Straight connector to angled socket</b>					
22260137	AB-C8-M12MS-0,3PUR-M12FA	0.3	30	2	1
22260138	AB-C8-M12MS-0,6PUR-M12FA	0.6	30	2	1
22260139	AB-C8-M12MS-1,0PUR-M12FA	1	30	2	1
22260140	AB-C8-M12MS-2,0PUR-M12FA	2	30	2	1

Unless specified otherwise, the shown product values are nominal values. Detailed values (e.g. tolerances) are available upon request.  
 Copper price basis: inclusive of copper. Refer to catalogue appendix T17 for the definition and calculation of copper-related surcharges.  
 Customised cable lengths, outer-sheath materials (e.g. PVC), and types of connectors are available upon request.  
 Photographs are not to scale and do not represent detailed images of the respective products.  
 For detailed technical information please refer to the data sheet  
 For the UNITRONIC® field bus type code, please see table T6  
 UL approvals can be found in the data sheet

### Accessories

- FLEXIMARK® Label LMB



## S/A cable: shielded, M 12 connector/socket on free conductor end



**Info**

- Suitable for drag chains

### Benefits

- Cost-saving due to quick and easy installation
- Space-saving due to compact dimensions
- Fast and easy error tracking
- Standardised interfaces

### Application range

- Automation technology
- Mechanical engineering
- Plant engineering
- Tool shop
- Automotive industry

### Product features

- 3, 4 and 5-pin version
- Plug/socket with M 12 thread to free conductor end
- The cables have marker carriers
- Free of paint-wetting impairment substances
- Suitable for drag chains

### Design

- Fixed flexible control cable
- Design:
  - 3 x 0.34 mm<sup>2</sup> (42 x 0.1 mm)
  - 4 x 0.34 mm<sup>2</sup> (42 x 0.1 mm)
  - 5 x 0.34 mm<sup>2</sup> (42 x 0.1 mm)
- Outer sheath: PUR, halogen-free, screened
- Outer sheath colour: black
- Shielding is conducted over the knurl

### Technical data

<b>IP</b>	<b>Protection rating</b> IP65/IP67
<b>0+</b>	<b>Ambient temperature (operation)</b> Plug/socket -25°C to +90°C Cable, fixed installation -25°C to +80°C Cable, flexible installation -5°C to +80°C
	<b>Contact material</b> CuSn
	<b>Contact surface material</b> Ni/Au
	<b>Coding</b> A-Standard
	<b>Knurl material</b> Zinc die-cast, nickel-plated
	<b>Gripping body material</b> TPU, flame-retardant, self-extinguishing

Article number	Article designation	Length (m)	Nominal voltage U <sub>n</sub> (V)	Nominal current I <sub>n</sub> in (A)	PU
<b>3-pin straight connector</b>					
22260453	AB-C3-M12MS- 2,0PUR-SH	2	250	4	1
22260454	AB-C3-M12MS- 5,0PUR-SH	5	250	4	1
22260455	AB-C3-M12MS-10,0PUR-SH	10	250	4	1
<b>3-pin straight socket</b>					
22260450	AB-C3- 2,0PUR-M12FS-SH	2	250	4	1
22260451	AB-C3- 5,0PUR-M12FS-SH	5	250	4	1
22260452	AB-C3-10,0PUR-M12FS-SH	10	250	4	1
<b>3-pin angled socket</b>					
22260071	AB-C3- 2,0PUR-M12FA-SH	2	250	4	1
22260072	AB-C3- 5,0PUR-M12FA-SH	5	250	4	1
22260073	AB-C3-10,0PUR-M12FA-SH	10	250	4	1
<b>4-pin straight connector</b>					
22260459	AB-C4-M12MS- 2,0PUR-SH	2	250	4	1
22260460	AB-C4-M12MS- 5,0PUR-SH	5	250	4	1
22260461	AB-C4-M12MS-10,0PUR-SH	10	250	4	1
<b>4-pin straight socket</b>					
22260456	AB-C4- 2,0PUR-M12FS-SH	2	250	4	1
22260457	AB-C4- 5,0PUR-M12FS-SH	5	250	4	1
22260458	AB-C4-10,0PUR-M12FS-SH	10	250	4	1
22260823	AB-C4-20,0PUR-M12FS-SH	20	250	4	1
<b>4-pin angled socket</b>					
22260074	AB-C4- 2,0PUR-M12FA-SH	2	250	4	1
22260675	AB-C4- 5,0PUR-M12FA-SH	5	250	4	1
22260680	AB-C4-10,0PUR-M12FA-SH	10	250	4	1
<b>5-pin straight connector</b>					
22260465	AB-C5-M12MS- 2,0PUR-SH	2	60	4	1
22260466	AB-C5-M12MS- 5,0PUR-SH	5	60	4	1
22260467	AB-C5-M12MS-10,0PUR-SH	10	60	4	1
<b>5-pin straight socket</b>					
22260462	AB-C5- 2,0PUR-M12FS-SH	2	60	4	1
22260463	AB-C5- 5,0PUR-M12FS-SH	5	60	4	1
22260464	AB-C5-10,0PUR-M12FS-SH	10	60	4	1
<b>5-pin angled socket</b>					
22260946	AB-C5- 2,0PUR-M12FA-SH	2	60	4	1
22260714	AB-C5- 5,0PUR-M12FA-SH	5	60	4	1
22260991	AB-C5-10,0PUR-M12FA-SH	10	60	4	1

Unless specified otherwise, the shown product values are nominal values. Detailed values (e.g. tolerances) are available upon request.  
 Copper price basis: inclusive of copper. Refer to catalogue appendix T17 for the definition and calculation of copper-related surcharges.  
 Customised cable lengths, outer-sheath materials (e.g. PVC), and types of connectors are available upon request.  
 Photographs are not to scale and do not represent detailed images of the respective products.  
 For detailed technical information please refer to the data sheet  
 For the UNITRONIC® field bus type code, please see table T6  
 UL approvals can be found in the data sheet

### Accessories

- FLEXIMARK® Label LMB



**New**

## S/A cable: Hygienic Design for Food&Beverage



### Benefits

- Hygienic Design for ideal cleaning results
- Guaranteed density by meeting the highest protection class
- Stainless steel knurl to ensure protection against corrosion
- Bright colors to detect contamination quickly
- Standardised interfaces

### Application range

- Food and beverage industry
- Automation technology
- Mechanical engineering
- Plant engineering

### Product features

- 4-pin connectors with M12 thread to free conductor end
- Hygienic Design
- Stainless steel knurl (V4A)

### Design

- Design: 4 x 0.34 mm<sup>2</sup> (42 x 0.1 mm)
- Core colours: brown(1), white(2), blue(3), black(4)
- Outer sheath: TPE, halogen-free
- Outer sheath colour: grey RAL 7035

### Technical data

- IP Protection rating**  
IP65/IP67/IP68/IP69K
- Ambient temperature (operation)**  
Plug/socket -40°C to +105°C  
Cable, fixed installation -40°C to +105°C
- Contact material**  
CuSn
- Contact surface material**  
Ni/Au
- Coding**  
A-Standard
- Knurl material**  
Stainless steel
- Gripping body material**  
PP

Article number	Article designation	Number of pins	Length (m)	Nominal voltage U <sub>N</sub> (V)	Nominal current I <sub>N</sub> in (A)	PU
<b>Straight connector</b>						
22262040	AB-C4-M12MS-2,0TPE-HD	4	2.0	250	4	1
22262041	AB-C4-M12MS-5,0TPE-HD	4	5.0	250	4	1
22262060	AB-C4-M12MS-7,5TPE-HD	4	7.5	250	4	1
22262042	AB-C4-M12MS-10,0TPE-HD	4	10.0	250	4	1
22262061	AB-C4-M12MS-15,0TPE-HD	4	15.0	250	4	1
<b>Straight socket</b>						
22262043	AB-C4-2,0TPE-M12FS-HD	4	2.0	250	4	1
22262044	AB-C4-5,0TPE-M12FS-HD	4	5.0	250	4	1
22262062	AB-C4-7,5TPE-M12FS-HD	4	7.5	250	4	1
22262045	AB-C4-10,0TPE-M12FS-HD	4	10.0	250	4	1
22262063	AB-C4-15,0TPE-M12FS-HD	4	15.0	250	4	1
<b>Angled socket</b>						
22262046	AB-C4-2,0TPE-M12FA-HD	4	2.0	250	4	1
22262047	AB-C4-5,0TPE-M12FA-HD	4	5.0	250	4	1
22262064	AB-C4-7,5TPE-M12FA-HD	4	7.5	250	4	1
22262048	AB-C4-10,0TPE-M12FA-HD	4	10.0	250	4	1
22262065	AB-C4-15,0TPE-M12FA-HD	4	15.0	250	4	1

Unless specified otherwise, the shown product values are nominal values. Detailed values (e.g. tolerances) are available upon request.  
 Customised cable lengths are available upon request.  
 Photographs are not to scale and do not represent detailed images of the respective products.  
 For detailed technical information please refer to the data sheet  
 For the UNITRONIC® field bus type code, please see table T6



**New**

## Field mountable S/A connectors M 12 for Food&Beverage



### ■ Benefits

- Stainless steel knurl to ensure protection against corrosion
- Quick and easy on-site assembly
- Creating individual cable lengths
- Standardised interfaces

### ■ Application range

- Food and beverage industry
- Mechanical engineering
- Automation technology
- Plant engineering

### ■ Product features

- 4-pin connector
- Stainless steel knurl (V4A)
- Screw termination
- Free of paint-wetting impairment substances

### ■ Technical data

<b>IP</b>	<b>Protection rating</b> IP67
<b>0+</b>	<b>Ambient temperature (operation)</b> Plug/socket -40°C to +85°C
	<b>Contact material</b> CuZn (brass)
	<b>Contact surface material</b> Au (gold)
	<b>Coding</b> A-Standard
	<b>Knurl material</b> Stainless steel

Article number	Article designation	Number of pins	Min. conductor cross-section, flexible, in mm <sup>2</sup>	Max. conductor cross-section, flexible, in mm <sup>2</sup>	Min. cable diameter (mm)	Max. cable diameter (mm)	Nominal voltage U <sub>N</sub> (V)	Nominal current I <sub>N</sub> in (A)	PU
<b>Angled socket, screw connection</b>									
22262051	AB-C4-M12FA-PG7-VA	4	0.25	0.75	4.0	6.0	250	4	1
<b>Straight socket, screw connection</b>									
22262050	AB-C4-M12FS-PG7-VA	4	0.25	0.75	4.0	6.0	250	4	1
<b>Straight connector, screw connection</b>									
22262049	AB-C4-M12MS-PG7-VA	4	0.25	0.75	4.0	6.0	250	4	1

Unless specified otherwise, the shown product values are nominal values. Detailed values (e.g. tolerances) are available upon request. Photographs are not to scale and do not represent detailed images of the respective products. For detailed technical information please refer to the data sheet. For the UNITRONIC® field bus type code, please see table T6



## S/A cable: straight M12 Y plug on 2x free conductor end

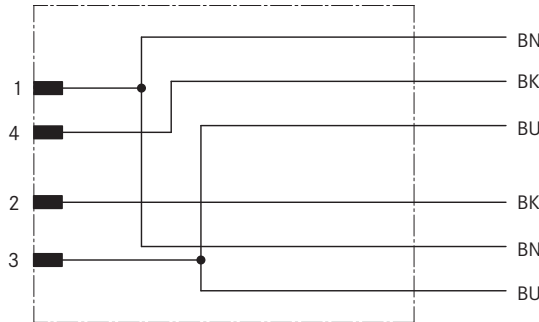

### Benefits

- Cost-saving due to quick and easy installation
- Space-saving due to compact dimensions
- Standardised interfaces

### Application range

- Automation technology
- Mechanical engineering
- Plant engineering
- Tool shop
- Automotive industry

### Product features

- 4-pin M12 Y connector
- Straight M12 Y plug to 2 conductor ends
- The cables have marker carriers
- Free of paint-wetting impairment substances
- Suitable for drag chains

### Design

- Fixed flexible control cable
- Design: 3 x 0.34 mm<sup>2</sup> (42 x 0.1 mm)
- Core colours: brown, blue, black
- Outer sheath: PUR, halogen-free
- Outer sheath colour: black

### Technical data

- IP Protection rating**  
IP65/IP67/IP68
- Ambient temperature (operation)**  
Plug/socket  
-25°C to +90°C  
Cable, fixed installation  
-40°C to +80°C  
Cable, flexible installation  
-25°C to +80°C
- Contact material**  
CuSn
- Contact surface material**  
Ni/Au
- Coding**  
A-Standard
- Knurl material**  
Zinc die-cast, nickel-plated
- Gripping body material**  
TPU, flame-retardant, self-extinguishing

Article number	Article designation	Length (m)	Nominal current I <sub>n</sub> in (A)	PU
<b>Y plug to 2 x free conductor end</b>				
22260500	AB-C3-M12Y-2,0PUR	2	4	1
22260513	AB-C3-M12Y-5,0PUR	5	4	1
22260526	AB-C3-M12Y-10,0PUR	10	4	1

Unless specified otherwise, the shown product values are nominal values. Detailed values (e.g. tolerances) are available upon request.  
 Copper price basis: inclusive of copper. Refer to catalogue appendix T17 for the definition and calculation of copper-related surcharges.  
 Photographs are not to scale and do not represent detailed images of the respective products.  
 For detailed technical information please refer to the data sheet  
 For the UNITRONIC® field bus type code, please see table T6  
 UL approvals can be found in the data sheet

### Accessories

- FLEXIMARK® Label LMB





## S/A cable: straight M12 Y plug on 2x M12 socket

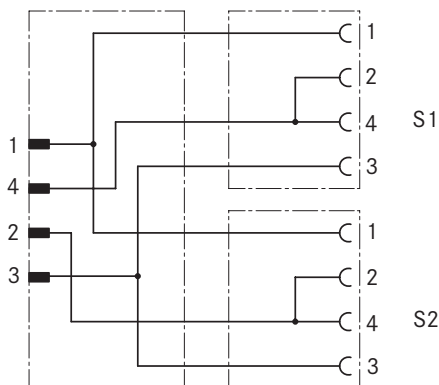

**Info**

- PIN 2+4 are bridged on M12 sockets

### Benefits

- Cost-saving due to quick and easy installation
- Space-saving due to compact dimensions
- Fast and easy error tracking
- Standardised interfaces

### Application range

- Automation technology
- Mechanical engineering
- Plant engineering
- Tool shop
- Automotive industry

### Product features

- 4-pin M12 Y connector on 2 x M12 socket (4-pin)
- Straight M12 Y plug to 2 conductor ends
- The cables have marker carriers
- Free of paint-wetting impairment substances
- Suitable for drag chains

### Design

- Fixed flexible control cable
- Design: 3 x 0.34 mm<sup>2</sup> (42 x 0.1 mm)
- Core colours: brown, blue, black
- Outer sheath: PUR, halogen-free
- Outer sheath colour: black

### Technical data

<b>IP</b>	<b>Protection rating</b> IP65/IP67/IP68
	<b>Ambient temperature (operation)</b> Plug/socket -25°C to +90°C Cable, fixed installation -40°C to +80°C Cable, flexible installation -25°C to +80°C
	<b>Contact material</b> CuSn
	<b>Contact surface material</b> Ni/Au
	<b>Coding</b> A-Standard
	<b>Knurl material</b> Zinc die-cast, nickel-plated
	<b>Gripping body material</b> TPU, flame-retardant, self-extinguishing

Article number	Article designation	Length (m)	Nominal current I <sub>N</sub> in (A)	Status display	PU
<b>Y plug to straight socket</b>					
22260501	AB-C3-M12Y-0,3PUR-M12FS-B	0.3	4	no	1
22260502	AB-C3-M12Y-0,6PUR-M12FS-B	0.6	4	no	1
22260503	AB-C3-M12Y-1,0PUR-M12FS-B	1	4	no	1
22260504	AB-C3-M12Y-2,0PUR-M12FS-B	2	4	no	1
<b>Y plug to angled socket</b>					
22260505	AB-C3-M12Y-0,3PUR-M12FA-B	0.3	4	no	1
22260506	AB-C3-M12Y-0,6PUR-M12FA-B	0.6	4	no	1
22260507	AB-C3-M12Y-1,0PUR-M12FA-B	1	4	no	1
22260508	AB-C3-M12Y-2,0PUR-M12FA-B	2	4	no	1
<b>Y plug to angled socket with LEDs</b>					
22260509	AB-C3-M12Y-0,3PUR-M12FA-2L-B	0.3	4	2 LED	1
22260510	AB-C3-M12Y-0,6PUR-M12FA-2L-B	0.6	4	2 LED	1
22260511	AB-C3-M12Y-1,0PUR-M12FA-2L-B	1	4	2 LED	1
22260512	AB-C3-M12Y-2,0PUR-M12FA-2L-B	2	4	2 LED	1

Unless specified otherwise, the shown product values are nominal values. Detailed values (e.g. tolerances) are available upon request. Copper price basis: inclusive of copper. Refer to catalogue appendix T17 for the definition and calculation of copper-related surcharges. Photographs are not to scale and do not represent detailed images of the respective products. For detailed technical information please refer to the data sheet. For the UNITRONIC® field bus type code, please see table T6. UL approvals can be found in the data sheet.

### Accessories

- FLEXIMARK® Label LMB



## S/A cable: straight M12 Y plug on 2x M8 socket

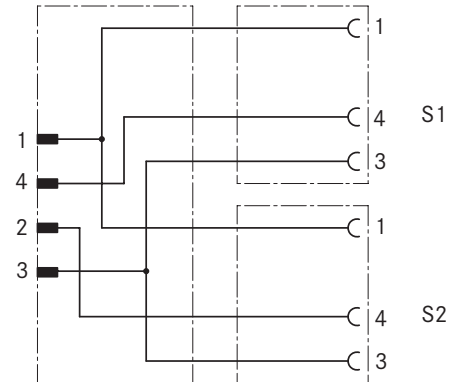

### Benefits

- Cost-saving due to quick and easy installation
- Space-saving due to compact dimensions
- Fast and easy error tracking
- Standardised interfaces

### Application range

- Automation technology
- Mechanical engineering
- Plant engineering
- Tool shop
- Automotive industry

### Product features

- 4-pin M12 Y connector on 2 x M8 socket (3-pin)
- Straight M12 Y plug to 2 conductor ends
- The cables have marker carriers
- Free of paint-wetting impairment substances
- Suitable for drag chains

### Design

- Fixed flexible control cable
- Design: 3 x 0.25 mm<sup>2</sup> (32 x 0.1 mm)
- Core colours: brown, blue, black
- Outer sheath: PUR, halogen-free
- Outer sheath colour: black

### Technical data

- IP Protection rating**  
IP65/IP67/IP68
- Ambient temperature (operation)**  
Plug/socket  
-25°C to +90°C  
Cable, fixed installation  
-40°C to +80°C  
Cable, flexible installation  
-25°C to +80°C
- Contact material**  
CuSn
- Contact surface material**  
Ni/Au
- Coding**  
A-Standard
- Knurl material**  
Zinc die-cast, nickel-plated
- Gripping body material**  
TPU, flame-retardant, self-extinguishing

Article number	Article designation	Length (m)	Nominal current I <sub>n</sub> in (A)	Status display	PU
<b>Y plug to straight socket</b>					
22260514	AB-C3-M12Y-0,3PUR-M8FS	0.3	3	no	1
22260515	AB-C3-M12Y-0,6PUR-M8FS	0.6	3	no	1
22260516	AB-C3-M12Y-1,0PUR-M8FS	1	3	no	1
22260517	AB-C3-M12Y-2,0PUR-M8FS	2	3	no	1
<b>Y plug to angled socket</b>					
22260518	AB-C3-M12Y-0,3PUR-M8FA	0.3	3	no	1
22260519	AB-C3-M12Y-0,6PUR-M8FA	0.6	3	no	1
22260520	AB-C3-M12Y-1,0PUR-M8FA	1	3	no	1
22260521	AB-C3-M12Y-2,0PUR-M8FA	2	3	no	1
<b>Y plug to angled socket with LEDs</b>					
22260522	AB-C3-M12Y-0,3PUR-M8FA-2L	0.3	3	2 LED	1
22260523	AB-C3-M12Y-0,6PUR-M8FA-2L	0.6	3	2 LED	1
22260524	AB-C3-M12Y-1,0PUR-M8FA-2L	1	3	2 LED	1
22260525	AB-C3-M12Y-2,0PUR-M8FA-2L	2	3	2 LED	1

Unless specified otherwise, the shown product values are nominal values. Detailed values (e.g. tolerances) are available upon request.  
 Copper price basis: inclusive of copper. Refer to catalogue appendix T17 for the definition and calculation of copper-related surcharges.  
 Photographs are not to scale and do not represent detailed images of the respective products.  
 For detailed technical information please refer to the data sheet  
 For the UNITRONIC® field bus type code, please see table T6  
 UL approvals can be found in the data sheet

### Accessories

- FLEXIMARK® Label LMB



## Y distributor



### ■ Benefits

- Cost-saving due to quick and easy installation
- Space-saving due to compact dimensions
- Fast and easy error tracking
- Standardised interfaces

### ■ Application range

- Automation technology
- Mechanical engineering
- Plant engineering
- Tool shop
- Automotive industry

### ■ Product features

- M12 and M8 design
- M12 design with screw hole
- Free of paint-wetting impairment substances

### ■ Technical data

<b>IP</b>	<b>Protection rating</b> IP65/IP67
<b>0+</b>	<b>Ambient temperature (operation)</b> Plug/socket -25°C to +90°C
	<b>Contact material</b> CuZn
	<b>Contact surface material</b> Ni/Au
	<b>Coding</b> A-Standard
	<b>Knurl material</b> Zinc die-cast, nickel-plated
	<b>Gripping body material</b> TPU, flame-retardant, self-extinguishing

Article number	Article designation	Nominal voltage U <sub>N</sub> (V)	Nominal current I <sub>N</sub> in (A)	PU
<b>M12 Y distributor, 3-pin, +PE, straight M12 connector to 2 x straight M12 socket, PIN 2+4 bridged</b>				
22260600	AB-C3-M12Y-2XM12FS B E	60	4	5
<b>M12 Y distributor, 3-pin, +PE, straight M12 connector to 2 x straight M12 socket</b>				
22260601	AB-C3-M12Y-2XM12FS E	60	4	5
<b>M12 Y distributor, 5-pin, straight M12 connector to 2 x straight M12 socket, parallel distributor</b>				
22260602	AB-C5-M12Y-2XM12FS V	60	4	5
<b>M8 Y distributor, with 4-pin M8 connector to 2 x 3-pin M8 socket</b>				
22260603	AB-C3-M8Y-2XM8FS	30	3	5
<b>M8 Y distributor, with M8 connector to M8 socket, 3-pin parallel distributor</b>				
22260604	AB-C3-M8Y-2XM8FS V	60	3	5

Unless specified otherwise, the shown product values are nominal values. Detailed values (e.g. tolerances) are available upon request.  
 Photographs are not to scale and do not represent detailed images of the respective products.  
 Note: the table value 'Number of pins' corresponds to the number of pins for sockets  
 For detailed technical information please refer to the data sheet  
 For the UNITRONIC® field bus type code, please see table T6

ÖLFLEX®  
 UNITRONIC®  
 ETHERLINE®  
 HITRONIC®  
 EPIC®  
 SKINTOP®  
 FLEXIMARK®  
 APPENDIX



## S/A cable: valve connector on free conductor end

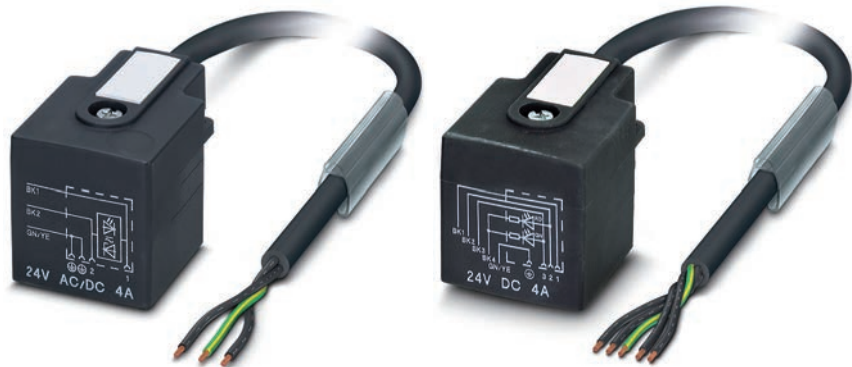

### Benefits

- Cost-saving due to quick and easy installation
- Space-saving due to compact dimensions
- Fast and easy error tracking
- Standardised interfaces

### Application range

- Automation technology
- Mechanical engineering
- Plant engineering
- Tool shop
- Automotive industry

### Product features

- 3- and 5-pin valve connectors
- With protective circuit (Z diode)  
PE-bridged  
Valve connector for pressure switches
- With LED status indicator (yellow)  
With display switch state  
(2 LEDs, red/green)
- The cables have marker carriers
- Free of paint-wetting impairment substances

### Design

- Cable design:  
3 x 0.5 mm<sup>2</sup> (28 x 0.15 mm)  
5 x 0.5 mm<sup>2</sup> (28 x 0,15mm)
- Core colours:  
black 1, black 2, green/yellow  
black 1, black 2, black 3, black 4,  
green/yellow
- Outer sheath: PUR, halogen-free
- Outer sheath colour: black (RAL 7021)
- Outer diameter:  
4.5 mm  
5.3 mm
- Suitable for drag chains

### Technical data

<b>IP</b>	<b>Protection rating</b> IP 67
<b>⚡</b>	<b>Ambient temperature (operation)</b> Valve connector -20°C to +85°C Cable, fixed installation -40°C to +80°C Cable, flexible installation -15°C to +80°C
	<b>Contact material</b> CuSn
	<b>Contact surface material</b> Ag
	<b>Coding</b> A-Standard

Article number	Article designation	Length (m)	Nominal voltage U <sub>N</sub> (V)	Nominal current I <sub>N</sub> (A)	Status display	PU
<b>Valve connector type A (18 mm)</b>						
22260584	AB-C3- 2,0PUR-A-1L-S	2	24	4	1 LED	1
22260576	AB-C3- 5,0PUR-A-1L-S	5	24	4	1 LED	1
22260577	AB-C3-10,0PUR-A-1L-S	10	24	4	1 LED	1
<b>Valve connector type A (18mm) for pressure switch</b>						
22260589	AB-C5-2,0PUR-AD-2L	2	24	4	2 LED	1
22260590	AB-C5-5,0PUR-AD-2L	5	24	4	2 LED	1
22260591	AB-C5-10,0PUR-AD-2L	10	24	4	2 LED	1
<b>Valve connector type B (10 mm)</b>						
22260585	AB-C3- 2,0PUR-B-1L-S	2	24	4	1 LED	1
22260578	AB-C3- 5,0PUR-B-1L-S	5	24	4	1 LED	1
22260579	AB-C3-10,0PUR-B-1L-S	10	24	4	1 LED	1
<b>Valve connector type BI (11 mm)</b>						
22260586	AB-C3- 2,0PUR-BI-1L-S	2	24	4	1 LED	1
22260580	AB-C3- 5,0PUR-BI-1L-S	5	24	4	1 LED	1
22260581	AB-C3-10,0PUR-BI-1L-S	10	24	4	1 LED	1
<b>Valve connector type C (8 mm)</b>						
22260587	AB-C3- 2,0PUR-C-1L-S	2	24	4	1 LED	1
22260582	AB-C3- 5,0PUR-C-1L-S	5	24	4	1 LED	1
22260583	AB-C3-10,0PUR-C-1L-S	10	24	4	1 LED	1
<b>Valve connector type CI (9.4 mm)</b>						
22260588	AB-C3- 2,0PUR-CI-1L-S	2	24	4	1 LED	1
22260574	AB-C3- 5,0PUR-CI-1L-S	5	24	4	1 LED	1
22260575	AB-C3-10,0PUR-CI-1L-S	10	24	4	1 LED	1

Unless specified otherwise, the shown product values are nominal values. Detailed values (e.g. tolerances) are available upon request.  
Copper price basis: inclusive of copper. Refer to catalogue appendix T17 for the definition and calculation of copper-related surcharges.  
Photographs are not to scale and do not represent detailed images of the respective products.  
For detailed technical information please refer to the data sheet  
For the UNITRONIC® field bus type code, please see table T6

### Accessories

- FLEXIMARK® Label LMB



## S/A cable: valve connector on straight M12 plug



### Benefits

- Cost-saving due to quick and easy installation
- Space-saving due to compact dimensions
- Fast and easy error tracking
- Standardised interfaces

### Application range

- Automation technology
- Mechanical engineering
- Plant engineering
- Tool shop
- Automotive industry

### Product features

- 3- and 5-pin valve connectors
- With protective circuit (Z diode)  
PE-bridged  
Valve connector for pressure switches
- With LED status indicator (yellow)  
With display switch state  
(2 LEDs, red/green)
- The cables have marker carriers
- Free of paint-wetting impairment substances

### Design

- Cable design:  
3 x 0.5 mm<sup>2</sup> (28 x 0.15 mm)  
5 x 0.5 mm<sup>2</sup> (28 x 0,15mm)
- Core colours:  
black 1, black 2, green/yellow  
black 1, black 2, black 3, black 4,  
green/yellow
- Outer sheath: PUR, halogen-free
- Outer sheath colour: black (RAL 7021)
- Outer diameter:  
4.5 mm  
5.3 mm
- Suitable for drag chains

### Technical data



**Protection rating**  
IP 67



### Ambient temperature (operation)

Valve connector  
-20°C to +85°C

Connector/socket  
-25°C to +90°C

Cable, fixed installation  
-40°C to +80°C

Cable, flexible installation  
-15°C to +80°C

### Contact material

CuSn

### Contact surface material

Ni/Au

### Coding

A-Standard

### Knurl material

Zinc die-cast, nickel-plated

### Gripping body material

TPU, flame-retardant, self-extinguishing

Article number	Article designation	Length (m)	Nominal voltage U <sub>N</sub> (V)	Nominal current I <sub>N</sub> in (A)	Status display	PU
<b>Straight connector to valve connector type A (18 mm)</b>						
22260550	AB-C3-M12MS-0,3PUR-A-1L-S	0,3	24	4	1 LED	1
22260551	AB-C3-M12MS-0,6PUR-A-1L-S	0,6	24	4	1 LED	1
22260552	AB-C3-M12MS-1,0PUR-A-1L-S	1	24	4	1 LED	1
22260553	AB-C3-M12MS-2,0PUR-A-1L-S	2	24	4	1 LED	1
<b>Straight connector to valve connector type A (18mm) for pressure switch</b>						
22260573	AB-C5-M12MS-0,3PUR-AD-2L	0,3	24	4	2 LED	1
22260572	AB-C5-M12MS-0,6PUR-AD-2L	0,6	24	4	2 LED	1
22260571	AB-C5-M12MS-1,0PUR-AD-2L	1	24	4	2 LED	1
22260570	AB-C5-M12MS-2,0PUR-AD-2L	2	24	4	2 LED	1
<b>Straight connector to valve connector type B (10 mm)</b>						
22260558	AB-C3-M12MS-0,3PUR-B-1L-S	0,3	24	4	1 LED	1
22260559	AB-C3-M12MS-0,6PUR-B-1L-S	0,6	24	4	1 LED	1
22260560	AB-C3-M12MS-1,0PUR-B-1L-S	1	24	4	1 LED	1
22260561	AB-C3-M12MS-2,0PUR-B-1L-S	2	24	4	1 LED	1
<b>Straight connector to valve connector type Bi (11 mm)</b>						
22260554	AB-C3-M12MS-0,3PUR-Bi-1L-S	0,3	24	4	1 LED	1
22260555	AB-C3-M12MS-0,6PUR-Bi-1L-S	0,6	24	4	1 LED	1
22260556	AB-C3-M12MS-1,0PUR-Bi-1L-S	1	24	4	1 LED	1
22260557	AB-C3-M12MS-2,0PUR-Bi-1L-S	2	24	4	1 LED	1
<b>Straight connector to valve connector type C (8 mm)</b>						
22260566	AB-C3-M12MS-0,3PUR-C-1L-S	0,3	24	4	1 LED	1
22260567	AB-C3-M12MS-0,6PUR-C-1L-S	0,6	24	4	1 LED	1
22260568	AB-C3-M12MS-1,0PUR-C-1L-S	1	24	4	1 LED	1
22260569	AB-C3-M12MS-2,0PUR-C-1L-S	2	24	4	1 LED	1
<b>Straight connector to valve connector type Ci (9.4 mm)</b>						
22260562	AB-C3-M12MS-0,3PUR-Ci-1L-S	0,3	24	4	1 LED	1
22260563	AB-C3-M12MS-0,6PUR-Ci-1L-S	0,6	24	4	1 LED	1
22260564	AB-C3-M12MS-1,0PUR-Ci-1L-S	1	24	4	1 LED	1
22260565	AB-C3-M12MS-2,0PUR-Ci-1L-S	2	24	4	1 LED	1

Unless specified otherwise, the shown product values are nominal values. Detailed values (e.g. tolerances) are available upon request.  
Copper price basis: inclusive of copper. Refer to catalogue appendix T17 for the definition and calculation of copper-related surcharges.  
Photographs are not to scale and do not represent detailed images of the respective products.  
For detailed technical information please refer to the data sheet  
For the UNITRONIC® field bus type code, please see table T6

### Accessories

- FLEXIMARK® Label LMB





## S/A box with M8 slots and master cable

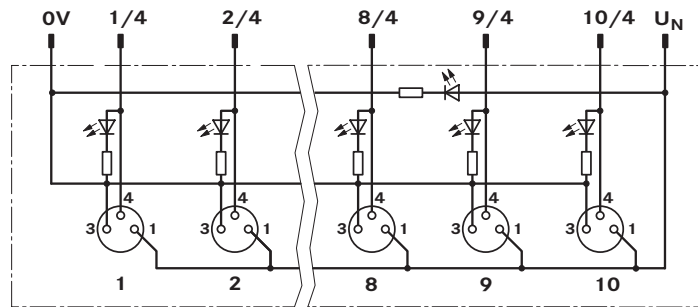

### Benefits

- Inexpensive and efficient wiring of sensors and actuators
- Instead of numerous individual conductors, one master cable is laid to the control unit
- The master cable is designed as a hybrid that transmits signals and power.
- There are no assembly costs as the master cable is already pre-assembled

### Application range

- Automation technology
- Mechanical engineering
- Plant engineering
- Tool shop
- Automotive industry

### Product features

- With fixed master cable connection
- Single-occupied sensor/actuator box
- LEDs indicate the operating mode of the distributor and the status of the sensors
- Free of paint-wetting impairment substances

### Norm references / Approvals

- E-File number: E75770

### Design

- PUR/PVC cable
- Fixed flexible control cable
- Outer sheath colour: black

### Suitable tools

- Suitable tools are available upon request (e.g. M8 torque screwdriver)

### Technical data

<b>IP</b>	<b>Protection rating</b> IP65/IP67
<b>0</b>	<b>Ambient temperature (operation)</b> -30°C to +80°C Cable, fixed installation -40°C to +90°C Cable, flexible installation -5°C to 80°C
<b>Amp.</b>	<b>Current rating per slot</b> 2 A

Article number	Article designation	Length (m)	Number of slots	Nominal voltage $U_N$ (V)	Total current (A)	Status display	PU
<b>Single occupied boxes, with LEDs</b>							
22260026	AB-B4-M8L-4-5,0PUR	5.0	4	24	6	With LEDs	1
22260027	AB-B4-M8L-4-10,0PUR	10.0	4	24	6	With LEDs	1
22260028	AB-B6-M8L-6-5,0PUR	5.0	6	24	6	With LEDs	1
22260029	AB-B6-M8L-6-10,0PUR	10.0	6	24	6	With LEDs	1
22260030	AB-B8-M8L-8-5,0PUR	5.0	8	24	6	With LEDs	1
22260031	AB-B8-M8L-8-10,0PUR	10.0	8	24	6	With LEDs	1
22260032	AB-B10-M8L-10-5,0PUR	5.0	10	24	6	With LEDs	1
22260033	AB-B10-M8L-10-10,0PUR	10.0	10	24	6	With LEDs	1

Unless specified otherwise, the shown product values are nominal values. Detailed values (e.g. tolerances) are available upon request.  
 Copper price basis: inclusive of copper. Refer to catalogue appendix T17 for the definition and calculation of copper-related surcharges.  
 Photographs are not to scale and do not represent detailed images of the respective products.  
 For the UNITRONIC® field bus type code, please see table T6  
 Unused female connectors must be covered with protective caps (see accessories). (M8: 22260606, M12: 22260605)  
 For detailed technical information please refer to the data sheet

### Accessories

- Screw plug for unoccupied sockets refer to page 112



## S/A box with M8 slots and master cable connection M16/M12

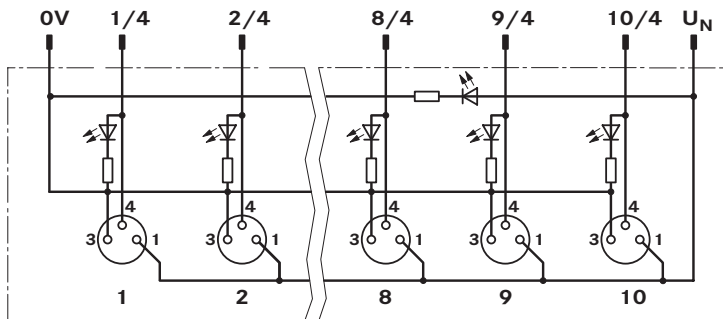

### Benefits

- Inexpensive and efficient wiring of sensors and actuators
- Instead of numerous individual conductors, one master cable is laid to the control unit
- The detachable screw connection ensures universal pluggability and simple on-site assembly

### Application range

- Automation technology
- Mechanical engineering
- Plant engineering
- Tool shop
- Automotive industry

### Product features

- With M12/M16 plug-in connection
- Single-occupied sensor/actuator box
- LEDs indicate the operating mode of the distributor and the status of the sensors
- Free of paint-wetting impairment substances

### Norm references / Approvals

- E-File number: E75770

### Suitable cables

- M16 socket with connected master cable Page 110
- M12 socket with connected master cable Page 111

### Suitable tools

- Suitable tools are available upon request (e.g. M8 torque screwdriver)

### Technical data

<b>IP</b>	<b>Protection rating</b> IP65/IP67
<b>0</b>	<b>Ambient temperature (operation)</b> -30°C to +80°C
<b>Amp.</b>	<b>Current rating per slot</b> 2 A

Article number	Article designation	Number of slots	Nominal voltage $U_N$ (V)	Total current (A)	Status display	PU
<b>With M16, 8-pin master cable connection</b>						
22260034	AB-B4-M8L-4-M16	4	24	6	With LEDs	1
<b>With M16, 10-pin master cable connection</b>						
22260035	AB-B6-M8L-6-M16	6	24	6	With LEDs	1
<b>With M16, 12-pin master cable connection</b>						
22260036	AB-B8-M8L-8-M16	8	24	6	With LEDs	1
<b>With M16, 14-pin master cable connection</b>						
22260037	AB-B10-M8L-10-M16	10	24	6	With LEDs	1
<b>With M12, 8-pin master cable connection</b>						
22260038	AB-B4-M8L-4-M12	4	24	4	With LEDs	1
22260039	AB-B6-M8L-6-M12	6	24	4	With LEDs	1

Unless specified otherwise, the shown product values are nominal values. Detailed values (e.g. tolerances) are available upon request. Photographs are not to scale and do not represent detailed images of the respective products. For the UNITRONIC® field bus type code, please see table T6. Unused female connectors must be covered with protective caps (see accessories). (M8: 22260606, M12: 22260605) For detailed technical information please refer to the data sheet

### Accessories

- Screw plug for unoccupied sockets refer to page 112



## S/A box with M 12 slots and master cable

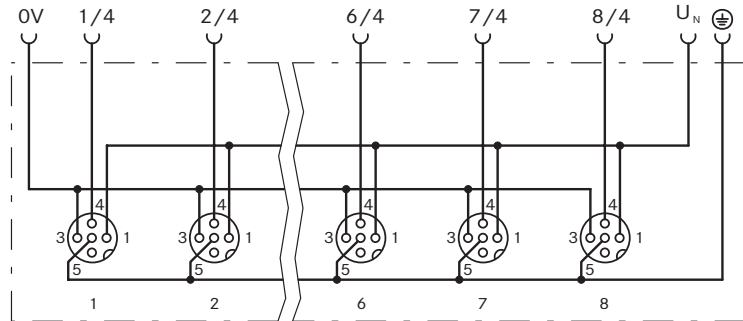

### Benefits

- Inexpensive and efficient wiring of sensors and actuators
- Instead of numerous individual conductors, one master cable is laid to the control unit
- The master cable is designed as a hybrid that transmits signals and power.
- There are no assembly costs as the master cable is already pre-assembled

### Application range

- Automation technology
- Mechanical engineering
- Plant engineering
- Tool shop
- Automotive industry

### Product features

- With fixed master cable connection
- Single or double-occupied sensor/actuator box
- With M 12 quick-locking system, metal thread
- With LED diagnostic indicator
- Free of paint-wetting impairment substances

### Norm references / Approvals

- E-File number: E75770

### Design

- PUR/PVC cable
- Fixed flexible control cable
- Outer sheath colour: black

### Suitable tools

- Suitable tools are available upon request (e.g. M 12 torque screwdriver)

### Technical data

<b>IP</b>	<b>Protection rating</b> IP65/IP67/IP69K
<b>Amp.</b>	<b>Max. current rating per path</b> 2 A
<b>Amp.</b>	<b>Current rating per slot</b> 4 A

Article number	Article designation	Length (m)	Number of slots	Nominal voltage U <sub>N</sub> (V)	Total current (A)	Status display	PU
<b>Single-occupied boxes, without LEDs</b>							
22260010	AB-B4-M12-4-5,0PUR	5.0	4	120	12	no	1
22260011	AB-B4-M12-4-10,0PUR	10.0	4	120	12	no	1
22260014	AB-B8-M12-8-5,0PUR	5.0	8	120	12	no	1
22260015	AB-B8-M12-8-10,0PUR	10.0	8	120	12	no	1
<b>Single occupied boxes, with LEDs</b>							
22260018	AB-B4-M12L-4-5,0PUR	5.0	4	24	12	With LEDs	1
22260019	AB-B4-M12L-4-10,0PUR	10.0	4	24	12	With LEDs	1
22260970	AB-B6-M12L-6-5,0PUR	5.0	6	24	12	With LEDs	1
22260022	AB-B8-M12L-8-5,0PUR	5.0	8	24	12	With LEDs	1
22260023	AB-B8-M12L-8-10,0PUR	10.0	8	24	12	With LEDs	1
<b>Double-occupied boxes, without LEDs</b>							
22260012	AB-B4-M12-8-5,0PUR	5.0	4	120	12	no	1
22260013	AB-B4-M12-8-10,0PUR	10.0	4	120	12	no	1
22260016	AB-B8-M12-16-5,0PUR	5.0	8	120	12	no	1
22260017	AB-B8-M12-16-10,0PUR	10.0	8	120	12	no	1
<b>Double-occupied boxes, with LEDs</b>							
22260020	AB-B4-M12L-8-5,0PUR	5.0	4	24	12	With LEDs	1
22260021	AB-B4-M12L-8-10,0PUR	10.0	4	24	12	With LEDs	1
22260024	AB-B8-M12L-16-5,0PUR	5.0	8	24	12	With LEDs	1
22260025	AB-B8-M12L-16-10,0PUR	10.0	8	24	12	With LEDs	1

Unless specified otherwise, the shown product values are nominal values. Detailed values (e.g. tolerances) are available upon request. Copper price basis: inclusive of copper. Refer to catalogue appendix T17 for the definition and calculation of copper-related surcharges. Photographs are not to scale and do not represent detailed images of the respective products. Unused female connectors must be covered with protective caps (see accessories). (M8: 22260606, M12: 22260605) For detailed technical information please refer to the data sheet ([www.lappautomation.com](http://www.lappautomation.com)). For the type code, please refer to table T6. UL approvals can be found in the data sheet

### Accessories

- Screw plug for unoccupied sockets refer to page 112



## S/A box with M12 slots and master cable connection

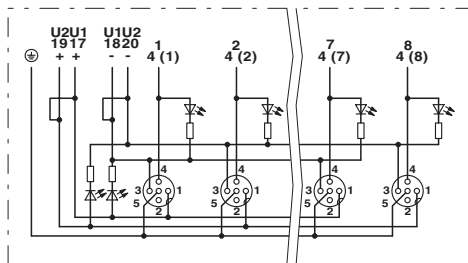

**Info**

- For individual master cable assembly

**Benefits**

- Inexpensive and efficient wiring of sensors and actuators
- Instead of numerous individual conductors, one master cable is laid to the control unit
- The detachable screw connection ensures universal pluggability and simple on-site assembly

**Application range**

- Automation technology
- Mechanical engineering
- Plant engineering
- Tool shop
- Automotive industry

**Product features**

- With detachable screw connection
- Single or double-occupied sensor/actuator box
- With M12 quick-locking system, metal thread
- With LED diagnostic indicator
- Free of paint-wetting impairment substances

**Suitable cables**

- UNITRONIC® SENSOR master cable bulk stock Page 109

**Suitable tools**

- Kraftform® adjustable torque screwdriver/ Kraftform Kompakt® Set
- Suitable tools are available upon request (e.g. M12 torque screwdriver)

**Technical data**

<b>IP</b>	<b>Protection rating</b> IP65/IP67/IP69K
<b>0</b>	<b>Ambient temperature (operation)</b> -30°C to +80°C
<b>Amp.</b>	<b>Max. current rating per path</b> 2 A
<b>Amp.</b>	<b>Current rating per slot</b> 4 A

Article number	Article designation	Number of slots	Nominal voltage U <sub>N</sub> (V)	Total current (A)	Status display	PU
<b>Single-occupied boxes, without LEDs, 4 slots, 1.)</b>						
22260005	AB-B4-M12-4-C	4	120	10	no	1
<b>Single-occupied boxes, without LEDs, 8 slots, 2.)</b>						
22260007	AB-B8-M12-8-C	8	120	10	no	1
<b>Single-occupied boxes, with LEDs, 4 slots, 1.)</b>						
22260001	AB-B4-M12L-4-C	4	24	10	With LEDs	1
<b>Single-occupied boxes, with LEDs, 8 slots, 2.)</b>						
22260003	AB-B8-M12L-8-C	8	24	10	With LEDs	1
<b>Double-occupied boxes, without LEDs, 4 slots, 2.)</b>						
22260006	AB-B4-M12-8-C	4	120	10	no	1
<b>Double-occupied boxes, without LEDs, 8 slots, 3.)</b>						
22260008	AB-B8-M12-16-C	8	120	10	no	1
<b>Double-occupied boxes, with LEDs, 4 slots, 2.)</b>						
22260002	AB-B4-M12L-8-C	4	24	10	With LEDs	1
<b>Double-occupied boxes, with LEDs, 8 slots, 3.)</b>						
22260004	AB-B8-M12L-16-C	8	24	10	With LEDs	1

Unless specified otherwise, the shown product values are nominal values. Detailed values (e.g. tolerances) are available upon request.  
 Applicable replacement cover with pluggable screw connection: 22260009  
 Photographs are not to scale and do not represent detailed images of the respective products.  
 Unused female connectors must be covered with protective caps (see accessories). (M8: 22260606, M12: 22260605)  
 For detailed technical information please refer to the data sheet (www.lappautomation.com). For the type code, please refer to table T6.  
 1.) Compatible master cable: 7038880; 2.) Compatible master cable: 7038881; 3.) Compatible master cable: 7038882

**Accessories**

- Screw plug for unoccupied sockets refer to page 112



**New**

## UNITRONIC® SENSOR master cable bulk stock



Info

- Customised construction can be supported

### ■ Benefits

- Inexpensive and efficient wiring for S/A boxes with detachable master cable connection
- Can be used universally for S/A installations

### ■ Application range

- Automation technology
- Mechanical engineering
- Plant engineering
- Tool shop
- Automotive industry

### ■ Product features

- Cores for Power Supply: 3 x 0.75 mm<sup>2</sup> and 3 x 1.0 mm<sup>2</sup>
- Cores for Signalling cable: 4 x 0.34 mm<sup>2</sup>, 8 x 0.5 mm<sup>2</sup>, 16 x 0.5 mm<sup>2</sup>
- Suitable for drag chains
- Halogen-free

### ■ Design

- UNITRONIC® SENSOR Li9Y11 COMBI  
Conductor: bare copper strand, single wire diameter: 0.1 mm for 0.34 mm<sup>2</sup>, 0.18 mm for 0.5 mm<sup>2</sup>, 0.205 mm for 0.75 mm<sup>2</sup>, 0.15 mm for 1.0 mm<sup>2</sup>. Core insulation: halogen-free PP, outer sheath: halogen-free PUR acc. to DIN VDE 0250 part 818.
- Outer sheath colour: black (similar to RAL 9005)  
Core colors: see data sheet
- AWM UL Style 21198, 80 °C / 300V

Article number	Article designation	Dimensions (mm <sup>2</sup> )	Outer diameter (mm)	Core/outer sheath material	Colour	Copper index (kg/km)
<b>UNITRONIC® SENSOR COMBI</b>						
7038880	Li9Y11Y	3 x 0.75 + 4 x 0.34	6.6	PP/PUR	black	34.5
7038881	Li9Y11Y	3 x 1.0 + 8 x 0.5	8.4	PP/PUR	black	67.2
7038882	Li9Y11Y	3 x 1.0 + 16 x 0.5	9.8	PP/PUR	black	105.6

Unless specified otherwise, the shown product values are nominal values. Detailed values (e.g. tolerances) are available upon request.  
 Copper price basis: EUR 150/100kg. Refer to catalogue appendix T17 for the definition and calculation of copper-related surcharges.  
 Packaging size: Coil 100m  
 Cables are printed  
 Other variations are available upon request.  
 Photographs are not to scale and do not represent detailed images of the respective products.  
 For detailed technical information please refer to the data sheet

### ■ Accessories

- S/A box with M12 slots and master cable connection refer to page 108





## M 16 socket with connected master cable

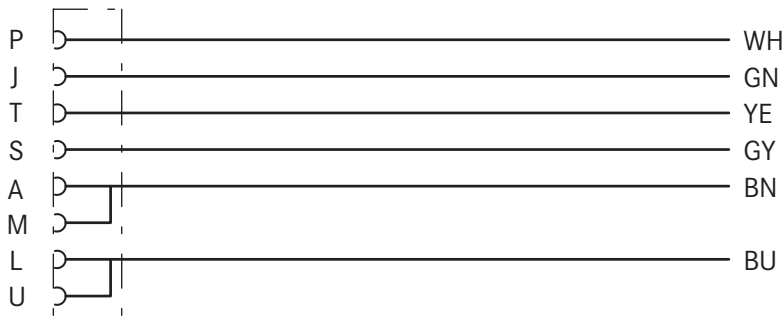

### Benefits

- Connecting cable for M8 boxes with 4 to 10 slots
- M 16 connection

### Application range

- Automation technology
- Mechanical engineering
- Plant engineering
- Tool shop
- Automotive industry

### Product features

- Angled socket with M 16 thread
- Free of paint-wetting impairment substances
- Suitable for drag chains

### Design

- PUR/PVC cable
- Fixed flexible control cable
- Outer sheath colour: black
- Core cross-section for power supply: 0.75 mm<sup>2</sup>
- Core cross-section for signalling cable: 0.34 mm<sup>2</sup>

### Technical data



**Protection rating**  
IP 67



**Ambient temperature (operation)**  
Plug/socket  
-25°C to +90°C  
Cable, fixed installation  
-40°C to +90°C  
Cable, flexible installation  
-5°C to 80°C

**Contact material**  
CuZn

**Contact surface material**  
Ni/Au

**Coding**  
A-Standard

**Knurl material**  
Nickel-plated brass

**Gripping body material**  
TPU, flame-retardant, self-extinguishing

Article number	Article designation	Length (m)	Nominal voltage U <sub>N</sub> (V)	Nominal current I <sub>N</sub> in (A)	PU
<b>8 pole angled socket, 4 signalling cables, 2 power supply cables</b>					
22260607	AB-C8- 5,0PUR-M 16FA	5	125	4	1
22260608	AB-C8-10,0PUR-M 16FA	10	125	4	1
<b>10-pin angled-socket, 6 signalling cables, 2 power supply cables</b>					
22260609	AB-C10- 5,0PUR-M 16FA	5	125	4	1
22260610	AB-C10-10,0PUR-M 16FA	10	125	4	1
<b>12-pin angled socket, 8 signalling cables, 2 power supply cables</b>					
22260611	AB-C12- 5,0PUR-M 16FA	5	125	4	1
22260612	AB-C12-10,0PUR-M 16FA	10	125	4	1
<b>14-pin angled socket, 10 signalling cables, 2 power supply cables</b>					
22260613	AB-C14- 5,0PUR-M 16FA	5	125	4	1
22260614	AB-C14-10,0PUR-M 16FA	10	125	4	1

Unless specified otherwise, the shown product values are nominal values. Detailed values (e.g. tolerances) are available upon request.  
Copper price basis: inclusive of copper. Refer to catalogue appendix T 17 for the definition and calculation of copper-related surcharges.  
Customised cable lengths are available upon request.  
Photographs are not to scale and do not represent detailed images of the respective products.  
For detailed technical information please refer to the data sheet  
For the UNITRONIC® field bus type code, please see table T6



## M 12 socket with connected master cable

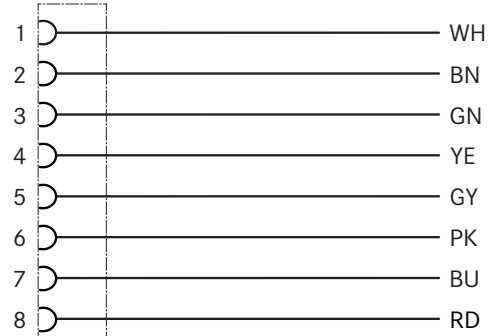

### Benefits

- Connecting cable for M8 boxes with 4 to 6 slots
- M 12 connection

### Application range

- Automation technology
- Mechanical engineering
- Plant engineering
- Tool shop
- Automotive industry

### Product features

- Angled socket with M 12 thread
- Free of paint-wetting impairment substances
- Suitable for drag chains

### Design

- PUR/PVC cable
- Fixed flexible control cable
- Outer sheath colour: black
- Core cross section: 0.25 mm<sup>2</sup>

### Technical data

- IP Protection rating**  
IP65/IP67/IP68
- Ambient temperature (operation)**  
Plug/socket  
-25°C to +90°C  
Cable, fixed installation  
-40°C to +80°C  
Cable, flexible installation  
-25°C to +80°C
- Contact material**  
CuZn
- Contact surface material**  
Ni/Au
- Coding**  
A-Standard
- Knurl material**  
Zinc die-cast, nickel-plated
- Gripping body material**  
TPU, flame-retardant, self-extinguishing

Article number	Article designation	Length (m)	Nominal voltage U <sub>N</sub> (V)	Nominal current I <sub>N</sub> in (A)	PU
<b>8 pole angled socket</b>					
22260615	AB-C8-5,0PUR-M12FA	5	30	2	1
22260616	AB-C8-10,0PUR-M12FA	10	30	2	1

Unless specified otherwise, the shown product values are nominal values. Detailed values (e.g. tolerances) are available upon request.  
 Copper price basis: inclusive of copper. Refer to catalogue appendix T 17 for the definition and calculation of copper-related surcharges.  
 Customised cable lengths are available upon request.  
 Photographs are not to scale and do not represent detailed images of the respective products.  
 For detailed technical information please refer to the data sheet  
 For the UNITRONIC® field bus type code, please see table T 6



## Screw plug for unoccupied sockets



### Benefits

- Protective cap for unused M8/M12 slots
- Protective cap for unused connectors (e.g. S/A boxes)

### Application range

- Automation technology
- Mechanical engineering
- Plant engineering
- Tool shop
- Automotive industry

### Product features

- Free of paint-wetting impairment substances

### Suitable tools

- Kraftform® adjustable torque screwdriver/ Kraftform Kompakt® Set

Article number	Article designation	PU
<b>M8</b>		
22260606	AB-B-M8-PC	10
<b>M12</b>		
22260605	AB-B-M12-PC	10

Unless specified otherwise, the shown product values are nominal values. Detailed values (e.g. tolerances) are available upon request. Photographs are not to scale and do not represent detailed images of the respective products. For detailed technical information please refer to the data sheet



## Complete connection hood with 4, 6 or 8 slots



### Benefits

- Pluggable screw connection as accessory for S/A box with detachable master cable connection
- The detachable screw connection ensures universal pluggability and simple on-site assembly

### Application range

- Automation technology
- Mechanical engineering
- Plant engineering
- Tool shop
- Automotive industry

### Product features

- Accessory for S/A box with detachable master cable connection
- With detachable screw connection

### Suitable tools

- Kraftform® adjustable torque screwdriver/ Kraftform Kompakt® Set

Article number	Article designation	PU
<b>Accessories</b>		
22260009	AB-B-HC	1

Unless specified otherwise, the shown product values are nominal values. Detailed values (e.g. tolerances) are available upon request. Photographs are not to scale and do not represent detailed images of the respective products. For detailed technical information please refer to the data sheet



## Field mountable S/A connectors M 12



### Benefits

- Quick and easy on-site assembly
- Creating individual cable lengths
- Standardised interfaces
- No special tools required for connecting the cables (fast-connect designs)

### Application range

- Automation technology
- Mechanical engineering
- Plant engineering
- Tool shop
- Automotive industry

### Product features

- 4, 5 and 8-pin version
- Screened and non-screened version
- Fast-connect and screw connection design
- Free of paint-wetting impairment substances

### Technical data

<b>IP</b>	<b>Protection rating</b> IP 65/IP 67 (IDC) IP 67 (screw)
<b>0-1</b>	<b>Ambient temperature (operation)</b> Plug/socket -25°C to +80°C (IDC) -25°C to +85°C (piercing) -40°C to +85°C (screw)
	<b>Contact material</b> CuZn
	<b>Contact surface material</b> CuSnZn
	<b>Coding</b> A-Standard

Article number	Article designation	Number of pins	Min. conductor cross-section, flexible, in mm <sup>2</sup>	Max. conductor cross-section, flexible, in mm <sup>2</sup>	Min. cable diameter (mm)	Max. cable diameter (mm)	Nominal voltage U <sub>N</sub> (V)	Nominal current I <sub>N</sub> in (A)	PU
<b>Straight connector, fast-connect (insulation displacement)</b>									
22260132	AB-C4-M12MS-F0,34	4	0.14	0.34	3.5	6	125	4	1
22260134	AB-C4-M12MS-F0,75	4	0.34	0.75	4	8	250	4	1
<b>Straight connector, screw connection</b>									
22260649	AB-C4-M12MS-PG7	4	0.25	0.75	4	6	250	4	1
22260995	AB-C4-M12MS-PG9	4	0.25	0.75	6	8	250	4	1
22260129	AB-C5-M12MS-PG7	5	0.25	0.75	4	6	60	4	1
22260651	AB-C5-M12MS-PG9	5	0.25	0.75	6	8	60	4	1
22260996	AB-C5-M12MS-PG9-SKINTOP®	5	0.25	0.75	6	8	125	4	1
<b>Straight socket, fast-connect (insulation displacement)</b>									
22260131	AB-C4-M12FS-F0,34	4	0.14	0.34	3.5	6	125	4	1
22260133	AB-C4-M12FS-F0,75	4	0.34	0.75	4	8	250	4	1
<b>Straight socket, screw connection</b>									
22260640	AB-C4-M12FS-PG7	4	0.25	0.75	4	6	250	4	1
22260641	AB-C4-M12FS-PG9	4	0.25	0.75	6	8	250	4	1
22260127	AB-C5-M12FS-PG7	5	0.25	0.75	4	6	60	4	1
22260644	AB-C5-M12FS-PG9	5	0.25	0.75	6	8	60	4	1
22260997	AB-C5-M12FS-PG9-SKINTOP®	5	0.25	0.75	6	8	125	4	1
<b>Angled connector, screw connection</b>									
22260647	AB-C4-M12MA-PG7	4	0.25	0.75	4	6	250	4	1
22260130	AB-C5-M12MA-PG7	5	0.25	0.75	4	6	60	4	1
22260648	AB-C5-M12MA-PG9	5	0.25	0.75	6	8	60	4	1
22262023	AB-C5-M12MA-PG9-SKINTOP®	5	0.25	0.75	6	8	60	4	1
<b>Angled socket, screw connection</b>									
22260636	AB-C4-M12FA-PG7	4	0.25	0.75	4	6	250	4	1
22260128	AB-C5-M12FA-PG7	5	0.25	0.75	4	6	60	4	1
22260638	AB-C5-M12FA-PG9	5	0.25	0.75	6	8	60	4	1
22262024	AB-C5-M12FA-PG9-SKINTOP®	5	0.25	0.75	6	8	60	4	1
<b>Straight connector, shielded, screw connection</b>									
22260135	AB-C5-M12MS-PG9-SH	5	0.25	0.75	6	8	60	4	1
22260825	AB-C8-M12MS-PG9-SH	8	0.25	0.75	6	8	30	2	1
<b>Straight socket, shielded, screw connection</b>									
22260136	AB-C5-M12FS-PG9-SH	5	0.25	0.75	6	8	60	4	1
22260826	AB-C8-M12FS-PG9-SH	8	0.25	0.75	6	8	30	2	1

Unless specified otherwise, the shown product values are nominal values. Detailed values (e.g. tolerances) are available upon request.

Photographs are not to scale and do not represent detailed images of the respective products.

For detailed technical information please refer to the data sheet

IDC = insulation displacement connector

For the UNITRONIC® field bus type code, please see table T6

**UNITRONIC® Fieldbus**

Field mountable connectors and wall ducts



## Field mountable S/A connectors M8



**Benefits**

- Quick and easy on-site assembly
- Creating individual cable lengths
- Standardised interfaces

**Application range**

- Automation technology
- Mechanical engineering
- Plant engineering
- Tool shop
- Automotive industry

**Product features**

- 3 and 4-pin version
- Fast-connect and screw connection design
- Free of paint-wetting impairment substances

**Suitable cables**

- UNITRONIC® SENSOR Page 115

**Technical data**

<b>IP</b>	<b>Protection rating</b> IP 65/IP 67 (IDC) IP 68 (piercing) IP 67 (screw)
	<b>Ambient temperature (operation)</b> Plug/socket -25°C to +80°C (IDC) -25°C to +85°C (piercing) -40°C to +85°C (screw)
	<b>Contact material</b> CuZn
	<b>Contact surface material</b> Au
	<b>Coding</b> A-Standard

Article number	Article designation	Number of pins	Min. conductor cross-section, flexible, in mm <sup>2</sup>	Max. conductor cross-section, flexible, in mm <sup>2</sup>	Min. cable diameter (mm)	Max. cable diameter (mm)	Nominal voltage U <sub>N</sub> (V)	Nominal current I <sub>N</sub> in (A)	PU
<b>Straight connector, fast-connect (insulation displacement)</b>									
22260993	AB-C3-M8MS-F0,25	3	0.08	0.25	2.5	5	60	4	1
22260985	AB-C3-M8MS-F0,5	3	0.25	0.5	2.5	5	60	4	1
22260043	AB-C4-M8MS-F0,25	4	0.08	0.25	2.5	5	30	4	1
22260044	AB-C4-M8MS-F0,5	4	0.25	0.5	2.5	5	30	4	1
<b>Straight connector, fast-connect (piercing)</b>									
22260122	AB-C3-M8MS-P	3	0.14	0.38	3	5	60	4	1
22260123	AB-C4-M8MS-P	4	0.14	0.38	3	5	30	4	1
<b>Straight connector, screw connection</b>									
22260120	AB-C3-M8MS	3	0.14	0.5	3.5	5	60	4	1
22260121	AB-C4-M8MS	4	0.14	0.5	3.5	5	30	4	1
<b>Straight socket, fast-connect (insulation displacement)</b>									
22260994	AB-C3-M8FS-F0,25	3	0.08	0.25	2.5	5	60	4	1
22260986	AB-C3-M8FS-F0,5	3	0.25	0.5	2.5	5	60	4	1
22260045	AB-C4-M8FS-F0,25	4	0.08	0.25	2.5	5	30	4	1
22260046	AB-C4-M8FS-F0,5	4	0.25	0.5	2.5	5	30	4	1
<b>Straight socket, fast-connect (piercing)</b>									
22260124	AB-C3-M8FS-P	3	0.14	0.38	3	5	60	4	1
22260119	AB-C4-M8FS-P	4	0.14	0.38	3	5	30	4	1
<b>Straight socket, screw connection</b>									
22260125	AB-C3-M8FS	3	0.14	0.5	3.5	5	60	4	1
22260126	AB-C4-M8FS	4	0.14	0.5	3.5	5	30	4	1
<b>Straight connector, shielded, screw connection</b>									
22262025	AB-C3-M8MS-M-0,34-SH	3	0.14	0.5	3.5	5.5	60	4	1
22262027	AB-C4-M8MS-M-0,34-SH	4	0.14	0.5	3.5	5	30	4	1
<b>Straight socket, shielded, screw connection</b>									
22262026	AB-C3-M8FS-M-0,34-SH	3	0.14	0.5	3.5	5.5	60	4	1
22262028	AB-C4-M8FS-M-0,34-SH	4	0.14	0.5	3.5	5.5	30	4	1

Unless specified otherwise, the shown product values are nominal values. Detailed values (e.g. tolerances) are available upon request. Photographs are not to scale and do not represent detailed images of the respective products. For detailed technical information please refer to the data sheet. IDC = insulation displacement connector. For the UNITRONIC® field bus type code, please see table T6.





## UNITRONIC® SENSOR



### Application range

- Cables for UNITRONIC® field bus sensor/actuator wiring
- Unshielded and shielded data transmission cables to connect to M8, M12 connectors
- Automation technology
- Mechanical engineering
- Plant engineering

### Product features

- Core colour code in accordance with DIN EN 50044
- 3 x 0.25 mm<sup>2</sup> or 0.34mm<sup>2</sup>  
1= brown, 2= blue, 3= black
- 4x 0.25 mm<sup>2</sup> or 0.34 mm<sup>2</sup>  
1= brown, 2= white, 3= blue, 4= black
- 5 x 0.25 mm<sup>2</sup> or 0.34 mm<sup>2</sup>  
1= brown, 2= white, 3= blue, 4= black, 5= grey
- 8x 0.25mm<sup>2</sup>  
1= white, 2=brown, 3= green, 4= yellow, 5= grey, 6= pink, 7=blue, 8= red

### Design

- UNITRONIC® SENSOR LiFY  
Conductor: extra-fine bare copper strand in accordance with DIN VDE 0295 Class 6; core insulation: PVC, outer sheath: PVC
- UNITRONIC® SENSOR DESINA® LiFY11Y  
Stranded bare copper conductor, super-fine. In accordance with VDE 0295 Class 6, special PVC insulation, cores twisted in layers, core identification in accordance with DESINA® (brown, white, blue, black). Outer sheath is made of special polyurethane-based compound; yellow colour in acc. to RAL 1021; flame retardant acc. to IEC 60332-1-2. Operating voltage= 48 V, Peak working voltage= 300 V.
- UNITRONIC® SENSOR FD Li9Y11Y and SENSOR FD Li9YC11Y AWM UL Style 20549, 80 °C/300 V. Conductor: Cu strand, bare, extra-fine wire according to DIN VDE 0295 Class 6, core insulation: modified polypropylene (PP), outer sheath: halogen-free polyurethane (PUR), matt, adhesion-free
- UNITRONIC® SENSOR FD series cables are specially designed for use in power chains

Article number	Article designation	Dimensions (mm <sup>2</sup> )	Outer diameter (mm)	Core/outer sheath material	Colour	Copper index (kg/km)
<b>UNITRONIC® SENSOR</b>						
7038859	S-LiFY	3 x 0.34	4.8	PVC/PVC	black	9.8
7038860	S-LiFY	4 x 0.34	4.8	PVC/PVC	black	13.1
0040434	DESINA	4 x 0.34	5.2	PVC/PUR	yellow (RAL 1021)	13.5
7038861	S-LiFY11Y	4 x 0.34	4.8	PVC/PUR	black	13.1
7038862	S-LiFY11Y	5 x 0.25	4.9	PVC/PUR	black	12.0
<b>UNITRONIC SENSOR FD</b>						
7038883	Li9Y11Y	3x0.25	4.4	PP/PUR	black	7.5
7038864	Li9Y11Y	3 x 0.34	4.6	PP/PUR	black	9.8
7038884	Li9Y11Y	4x0.25	4.7	PP/PUR	black	10.2
7038865	Li9Y11Y	4 x 0.34	4.7	PP/PUR	black	13.0
7038867	Li9Y11Y	5 x 0.25	4.7	PP/PUR	black	12.0
7038866	Li9Y11Y	5 x 0.34	5.1	PP/PUR	black	16.0
7038868	Li9Y11Y	8 x 0.25	5.9	PP/PUR	black	19.0
<b>UNITRONIC® SENSOR FD screened</b>						
7038885	Li9YC11Y	3 x 0.34	4.6	PP/PUR	black	19.1
7038886	Li9YC11Y	4 x 0.34	4.7	PP/PUR	black	23.5
7038887	Li9YC11Y	5 x 0.34	5.1	PP/PUR	black	27.5

Unless specified otherwise, the shown product values are nominal values. Detailed values (e.g. tolerances) are available upon request.  
 Copper price basis: EUR 150/100kg. Refer to catalogue appendix T17 for the definition and calculation of copper-related surcharges.  
 Please find our standard lengths at: [www.lappkabel.de/en/cable-standardlengths](http://www.lappkabel.de/en/cable-standardlengths)  
 Cables are printed  
 Other types of composition are available upon request.  
 Photographs are not to scale and do not represent detailed images of the respective products.

### Accessories

- Field mountable S/A connectors M12 refer to page 113
- Field mountable S/A connectors M8 refer to page 114
- STAR STRIP stripping tool
- SMART STRIP stripping tool



## S/A M 12 flush-type connectors



### ■ Benefits

- Flexible connection solutions for individual device concepts
- Simple installation in devices (e.g. cabinet)
- Standardised interfaces

### ■ Application range

- Automation technology
- Mechanical engineering
- Plant engineering
- Tool shop
- Automotive industry

### ■ Product features

- M 12 panel feed-throughs with punched-on single litz wires
- Panel feed-throughs with M 12, M 16 and PG 9 fastening thread
- Designs for front and rear wall-mounting
- M 12 A-coded with quick-locking system
- Free of paint-wetting impairment substances
- Can be positioned

### ■ Design

- TPE single litz wires, l = 0.5 m
- 0,34 mm<sup>2</sup>

### ■ Technical data

<b>IP</b>	<b>Protection rating</b> IP 67
	<b>Ambient temperature (operation)</b> Plug/socket -25°C to +85°C
	<b>Contact material</b> CuZn
	<b>Contact surface material</b> Au
	<b>Coding</b> A-Standard

Article number	Article designation	Number of pins	Conductor cross-section (mm <sup>2</sup> )	Nominal voltage U <sub>N</sub> (V)	Nominal current I <sub>N</sub> in (A)	PU
<b>M 12 flush-type connector pin for front-mounting, with M 16 fastening thread</b>						
22260108	AB-C4-M 12MS-M 16-0,5	4	0.34	250	4	1
22260106	AB-C5-M 12MS-M 16-0,5	5	0.34	60	4	1
<b>M 12 flush-type connector pin for front mounting, with PG9 fastening thread</b>						
22260113	AB-C4-M 12MS-PG9-0,5	4	0.34	250	4	1
22260112	AB-C5-M 12MS-PG9-0,5	5	0.34	60	4	1
<b>M 12 flush-type connector pin for front-mounting, can be positioned, with M 16 fastening thread</b>						
22260083	AB-C4-M 12MS-M 16-PO-0,5	4	0.34	250	4	1
22260084	AB-C5-M 12MS-M 16-PO-0,5	5	0.34	60	4	1
<b>M 12 flush-type connector pin for front-mounting, can be positioned, with PG9 fastening thread</b>						
22260087	AB-C4-M 12MS-PG9-PO-0,5	4	0.34	250	4	1
22260088	AB-C5-M 12MS-PG9-PO-0,5	5	0.34	60	4	1
<b>M 12 flush-type connector socket for front-mounting, with M 16 fastening thread</b>						
22260107	AB-C4-M 12FS-M 16-0,5	4	0.34	250	4	1
22260105	AB-C5-M 12FS-M 16-0,5	5	0.34	60	4	1
<b>M 12 flush-type connector socket for front-mounting, with PG9 fastening thread</b>						
22260114	AB-C4-M 12FS-PG9-0,5	4	0.34	250	4	1
22260111	AB-C5-M 12FS-PG9-0,5	5	0.34	60	4	1
<b>M 12 flush-type connector socket for front-mounting, can be positioned, with M 16 fastening thread</b>						
22260085	AB-C4-M 12FS-M 16-PO-0,5	4	0.34	250	4	1
22260086	AB-C5-M 12FS-M 16-PO-0,5	5	0.34	60	4	1
<b>M 12 flush-type connector socket for front-mounting, can be positioned, with PG9 fastening thread</b>						
22260089	AB-C4-M 12FS-PG9-PO-0,5	4	0.34	250	4	1
22260090	AB-C5-M 12FS-PG9-PO-0,5	5	0.34	60	4	1
<b>M 12 flush-type connector pin for rear-mounting (fitting nut included), with PG9 fastening thread</b>						
22260117	AB-C4-DSI-M 12MS-PG9-0,5	4	0.34	250	4	1
22260115	AB-C5-DSI-M 12MS-PG9-0,5	5	0.34	60	4	1
<b>M 12 flush-type connector socket for rear-mounting (fitting nut included), with PG9 fastening thread</b>						
22260118	AB-C4-DSI-M 12FS-PG9-0,5	4	0.34	250	4	1
22260116	AB-C5-DSI-M 12FS-PG9-0,5	5	0.34	60	4	1
<b>M 12 flush-type connector socket for rear-mounting, with M 12 fastening thread</b>						
22260999	AB-C4-DSI-M 12MS-M 12-0,5	4	0.34	250	4	1

Unless specified otherwise, the shown product values are nominal values. Detailed values (e.g. tolerances) are available upon request.  
 Copper price basis: inclusive of copper. Refer to catalogue appendix T 17 for the definition and calculation of copper-related surcharges.  
 Photographs are not to scale and do not represent detailed images of the respective products.  
 For detailed technical information please refer to the data sheet  
 For the UNITRONIC® field bus type code, please see table T6  
 1.) with quick-locking system

### ■ Accessories

- Fitting nut for flush-type connectors refer to page 118



**New**

## S/A M 12 control cabinet feed-through



### Benefits

- Flexible connection solutions
- Simple installation in devices (e.g. cabinet)
- Standardised interfaces

### Application range

- Automation technology
- Mechanical engineering
- Plant engineering
- Tool shop
- Automotive industry

### Product features

- Screened version
- Bipolar/screw mounting
- For CANopen/DeviceNet applications (A-coded)
- For PROFIBUS applications (B-inverse coded)
- For PROFINET applications (D-coded)

### Technical data

- IP Protection rating**  
IP67
- Ambient temperature (operation)**  
Plug/socket  
-25°C to +85°C
- Contact material**  
CuZn (brass)
- Contact surface material**  
Au (gold)

Article number	Article designation	Number of pins	Nominal voltage $U_N$ (V)	Nominal current $I_N$ in (A)	PU
<b>A coded</b>					
22262020	AB-C5-DSI-M12MS-M12FS-M16-SH	5	24	4	1
<b>B coded</b>					
22262021	AB-C5-DSI-M12MSB-M12FSB-M16-SH	5	60	4	1
<b>D coded</b>					
22262022	AB-C4-DSI-M12FSD-M12FSD-M16-SH	4	60	4	1

Unless specified otherwise, the shown product values are nominal values. Detailed values (e.g. tolerances) are available upon request. Photographs are not to scale and do not represent detailed images of the respective products. For detailed technical information please refer to the data sheet



## S/A M8 flush-type connectors



### Benefits

- Flexible connection solutions for individual device concepts
- Simple installation in devices (e.g. cabinet)
- Standardised interfaces

### Application range

- Automation technology
- Mechanical engineering
- Plant engineering
- Tool shop
- Automotive industry

### Product features

- M8 panel feed-through with punched-on single litz wires
- Panel feed-through with M8 fastening thread
- Front wall-mounting
- Protection rating: IP65/IP67
- Free of paint-wetting impairment substances

### Design

- TPE single litz wires, l = 0.5 m
- 0,25 mm<sup>2</sup>

### Technical data

	<b>Ambient temperature (operation)</b>
	Plug/socket -25°C to +85°C
	<b>Contact material</b> Copper alloy
	<b>Contact surface material</b> Au
	<b>Coding</b> A-Standard

Article number	Article designation	Number of pins	Conductor cross-section (mm <sup>2</sup> )	Nominal voltage U <sub>N</sub> (V)	Nominal current I <sub>N</sub> in (A)	PU
<b>M8 flush-type connector pin for front-mounting</b>						
22260100	AB-C3-M8MS-0,5	3	0.25	60	4	1
22260101	AB-C4-M8MS-0,5	4	0.25	30	4	1
<b>M8 flush-type connector socket for front-mounting</b>						
22260102	AB-C3-M8FS-0,5	3	0.25	60	4	1
22260103	AB-C4-M8FS-0,5	4	0.25	30	4	1

Unless specified otherwise, the shown product values are nominal values. Detailed values (e.g. tolerances) are available upon request.  
Copper price basis: inclusive of copper. Refer to catalogue appendix T17 for the definition and calculation of copper-related surcharges.  
Photographs are not to scale and do not represent detailed images of the respective products.  
For detailed technical information please refer to the data sheet  
For the UNITRONIC® field bus type code, please see table T6

### Accessories

- Fitting nut for flush-type connectors refer to page 118



## Fitting nut for flush-type connectors



### Benefits

- Flat nut as accessory for flush-type connectors

### Product features

- Material: nickel-plated brass

Article number	Article designation	PU
<b>M8 thread (M8 x 0.5 - SW 10), h = 2.2 mm</b>		
22260104	AB-C-M8-CN	100
<b>PG9 thread (PG9 - SW 18), h = 2.8 mm</b>		
22260109	AB-C-PG9-CN	100
<b>M16 thread (M16 x 1.5 - SW 19), h = 2.8 mm</b>		
22260110	AB-C-M16-CN	100
<b>M12 thread, EMC version (M12x1-SW 15), h=2.9 mm</b>		
22261062	AB-C-M12-CN-SH	100

Unless specified otherwise, the shown product values are nominal values. Detailed values (e.g. tolerances) are available upon request.  
Photographs are not to scale and do not represent detailed images of the respective products.  
For detailed technical information please refer to the data sheet

### Similar products

- SKINDICHT® SM



## AS-Interface Modules (IP67)

**Info**

- With M12 quick-locking system, metal thread
- AS-Interface installation without tools



### Benefits

- Standardised interfaces
- For decentralised automation
- Space-saving due to compact dimensions
- Easy to install
- Fast and easy error tracking

### Application range

- Automation technology
- Mechanical engineering
- Plant engineering
- Tool shop
- Automotive industry

### Product features

- AS-Interface module slave
- Integration of field bus activation and input/output level
- Digital inputs/outputs with M12 or M8 connection method for sensors/actuators
- Flat cable penetration technique as connection type for M12 module
- M12 connection type for M8 modules
- LED diagnostic and status indicators
- Short circuit/overload protection

### Norm references / Approvals

- UL: E334317

### Suitable cables

- UNITRONIC® BUS ASI Page 49
- UNITRONIC® BUS ASI FD Page 50

### Suitable tools

- Suitable tools are available upon request (e.g. M12 torque screwdriver)

### Technical data

#### Fieldbus system

AS-Interface

#### Connection type

Flat cable penetration technique/M12 connection type

#### Installation

Panel mounting for M12/M8 modules  
Top-hat rail (35 mm) for M12 modules

#### Number of pins

2



#### Protection rating

IP67

#### Protection class

III



#### Ambient temperature (operation)

-25 °C to +70 °C

#### Temperature (storage/transport)

-25 °C to +85 °C

#### Supply voltage

26.5 V DC PELV to 31.6 V DC PELV

Article number	Article designation	Connection systems (sensor/actuator)	Number of inputs	Number of outputs	Slave type	AS-i specification	Master specification	PU
<b>With digital inputs/outputs, M8, total current: 4 A</b>								
22260759	AB-ASI-M12-DI4DO4-M8-1A	2, 3-wire	4	4	Single-Slave	2	>= 2.0	1
<b>With digital inputs/outputs, M12, total current: 4 A</b>								
22260755	AB-ASI-DI2DO2-M12-2A	2, 3, 4-wire	2	2	A/B-Slave	2.1	>= 2.0	1
22260756	AB-ASI-DI4DO3-M12-2A	2, 3, 4-wire	4	3	A/B-Slave	2.1	>= 2.0	1
22260757	AB-ASI-DI4DO4-M12-2A	2, 3, 4-wire	4	4	A/B-Slave	3	>= 3.0	1

Unless specified otherwise, the shown product values are nominal values. Detailed values (e.g. tolerances) are available upon request.

Details of the clamping force are available upon request, halogen-free.

Photographs are not to scale and do not represent detailed images of the respective products.

For the UNITRONIC® field bus type code, please see table T6

Unused female connectors must be covered with protective caps (see accessories). (M8: 22260606, M12: 22260605)

### Accessories

- Power cable M12 (A-coded) refer to page 137
- AS-Interface Distributor refer to page 124
- AS-Interface power supply refer to page 126
- Screw plug for unoccupied sockets refer to page 112





## AS-Interface Modules (IP30)



**Info**

- Fully industrialised
- For panel mounting

### Benefits

- Standardised interfaces
- For decentralised automation
- Space-saving due to compact dimensions
- Easy to install
- Fast and easy error tracking

### Application range

- Automation technology
- Mechanical engineering
- Plant engineering
- Tool shop
- Automotive industry

### Product features

- AS-Interface module slave
- Integration of field bus activation and input/output level
- Metal housing
- Connection by optional screw-plug terminals or spring-plug terminals
- Digital inputs/outputs for connecting sensors/actuators
- LED diagnostic and status indicators
- Short circuit/overload protection

### Suitable cables

- UNITRONIC® BUS ASI Page 49
- UNITRONIC® BUS ASI FD Page 50

### Technical data

- Fieldbus system**  
AS-Interface
- Dimensions W x H x D (mm)**  
105 mm x 22.5 mm x 85 mm
- Connection type**  
Plug-in connection for screw-plug terminals or spring-plug terminals
- Installation**  
Top-hat rail (35 mm)
- Protection rating**  
IP30
- Protection class**  
II
- Ambient temperature (operation)**  
-25°C to +60°C
- Temperature (storage/transport)**  
-40°C to +85°C
- Permissible humidity (storage/transport)**  
max. 95 %, not condensing
- Supply voltage**  
26.5 V DC to 31.6 V DC

Article number	Article designation	Connection systems (sensor/actuator)	Number of inputs	Number of outputs	Slave type	AS-i specification	Master specification	PU
<b>4 inputs, 4 outputs (230 VAC/3A relays with changeover contacts)</b>								
22260807	AB-ASI-DI4DOR4-3A	2, 3-wire	4	4	Single-Slave	3.01	>= 3.0	1
<b>4 inputs, 4 outputs 2A</b>								
22260808	AB-ASI-DI4DO4-2A	2, 3-wire	4	4	Single-Slave	3.01	>= 3.0	1
<b>8 Inputs, 8 Outputs 2A</b>								
22260809	AB-ASI-DI8DO8-2A	2, 3-wire	8	8	Single-Slave	3.01	>= 3.0	1

Unless specified otherwise, the shown product values are nominal values. Detailed values (e.g. tolerances) are available upon request.

Plug terminals are not included, but can be purchased as an accessory.

Photographs are not to scale and do not represent detailed images of the respective products.

Other AS-Interface modules available on request

For the UNITRONIC® field bus type code, please see table T6

### Accessories

- Power cable M12 (A-coded) refer to page 137
- AS-Interface Distributor refer to page 124
- AS-Interface counter module refer to page 125
- AS-Interface power supply refer to page 126
- AS-Interface network extension refer to page 127



**Info**

- With M 12 quick-locking system, metal thread

## PROFIBUS Modules



### Benefits

- Standardised interfaces
- For decentralised automation
- Space-saving due to compact dimensions
- Easy to install
- Fast and easy error tracking

### Application range

- Automation technology
- Mechanical engineering
- Plant engineering
- Tool shop
- Automotive industry

### Product features

- PROFIBUS interface
- Integration of field bus activation and input/output level
- Connection to PROFIBUS DP using M 12 connectors (B-coded)
- Digital inputs/outputs with M 12 connection method for sensors/actuators
- LED diagnostic and status indicators
- Flexible power supply concept with M 12 connection
- Short circuit/overload protection

### Norm references / Approvals

- UL File: E334209; E334210

### Suitable cables

- PROFIBUS cable: M 12 connector on free conductor end Page 129
- PROFIBUS Cable: M 12 connector on M 12 socket Page 130

### Suitable tools

- Suitable tools are available upon request (e.g. M 12 torque screwdriver)

### Suitable connectors

- Field mountable S/A connectors M 12 Page 113
- BUS M 12 connectors that can be assembled

### Technical data

#### Fieldbus system

PROFIBUS-DP

#### Transmission speed

12 MBit/s  
Automatic baud rate detection

#### Transmission physics

PROFIBUS-DP-compliant copper cable

#### Space allocated for address

1 ... 99, can be set from front side

#### Connection type

Bus port:  
2 x M 12 plug connectors, B-coded

#### Installation

Flexible mounting (wall, DIN rail)

#### Number of pins

5



#### Protection rating

IP65/IP67 according to IEC 60529

#### Protection class

Class 3 as per VDE 0106, IEC 61440



#### Ambient temperature (operation)

-25°C to +60°C

#### Temperature (storage/transport)

-25 °C to +85 °C

#### Permissible humidity (storage/transport)

95 %

#### Transmission rate

9.64 Kbaud to 12 Mbaud automatic detection

#### Supply voltage

24V DC

Article number	Article designation	Connection systems (sensor/actuator)	Number of inputs	Number of outputs	Maximum output current per channel (A)	PU
<b>With digital inputs/outputs</b>						
22260740	AB-PB-DI4DO4-M 12-2A	2, 3, 4-wire	4	4	2	1
22260762	AB-PB-DI8DO8-M 12-0,5A	2, 3, 4-wire	8	8	0.5	1
<b>With digital inputs</b>						
22260738	AB-PB-DI8-M 12	2, 3, 4-wire	8			1
22260739	AB-PB-DI 16-M 12	2, 3, 4-wire	16			1
<b>With digital outputs</b>						
22260742	AB-PB-DO8-M 12-2A	2, 3-wire		8	2	1

Unless specified otherwise, the shown product values are nominal values. Detailed values (e.g. tolerances) are available upon request.

Photographs are not to scale and do not represent detailed images of the respective products.

For the UNITRONIC® field bus type code, please see table T6

Unused female connectors must be covered with protective caps (see accessories). (M8: 22260606, M12: 22260605)

### Accessories

- Power cable M 12 (A-coded) refer to page 137
- Screw plug for unoccupied sockets refer to page 112
- BUS M 12 connectors that can be assembled
- Terminating resistor M 12 for DeviceNet/CANopen/PROFIBUS refer to page 134
- M 12 T distributor for PROFIBUS refer to page 135



## DeviceNet Modules



**Info**

- With M12 quick-locking system, metal thread

### Benefits

- Standardised interfaces
- For decentralised automation
- Space-saving due to compact dimensions
- Easy to install
- Fast and easy error tracking

### Application range

- Automation technology
- Mechanical engineering
- Plant engineering
- Tool shop
- Automotive industry

### Product features

- DeviceNet Interface
- Integration of field bus activation and input/output level
- Connection to DeviceNet™ using M12 connectors (A-coded)
- Digital inputs/outputs with M12 connection method for sensors/actuators
- LED diagnostic and status indicators
- Flexible power supply concept with M12 connection
- Short circuit/overload protection

### Norm references / Approvals

- UL File: E334209; E334210

### Suitable cables

- DeviceNet/CANopen Cable, M12 connector on free conductor end Page 131
- S/A DeviceNet/CANopen cable, M12 connector on M12 socket Page 132

### Suitable tools

- Suitable tools are available upon request (e.g. M12 torque screwdriver)

### Suitable connectors

- Field mountable S/A connectors M12 Page 113

### Technical data

**Fieldbus system**  
DeviceNet

**Transmission speed**

125 kBit/s, 250 kBit/s, 500 kBit/s  
Automatic baud rate detection

**Transmission physics**

Copper cable in acc. with 176524 specification

**Space allocated for address**

0 ... 63, can be set

**Connection type**

Bus port:  
2 x M12 connectors, A-coded

**Installation**

Flexible mounting (wall, DIN rail)

**Number of pins**

5



**Protection rating**  
IP65/IP67

**Protection class**

Class 3 as per VDE 0106, IEC 61440



**Ambient temperature (operation)**  
-25 °C to +60 °C

**Temperature (storage/transport)**  
-25 °C to +85 °C

**Permissible humidity (storage/transport)**  
95 %

**Transmission rate**

125 kBaud, 250 kBaud, 500 kBaud  
automatic detection

**Supply voltage**

24V DC

Article number	Article designation	Connection systems (sensor/actuator)	Number of inputs	Number of outputs	Maximum output current per channel (A)	PU
<b>With digital inputs/outputs</b>						
22260745	AB-DN-DI4DO4-M12-2A	2, 3, 4-wire	4	4	2.0	1
22260763	AB-DN-DI8DO8-M12-0,5A	2, 3, 4-wire	8	8	0.5	1
<b>With digital inputs</b>						
22260743	AB-DN-DI8-M12	2, 3, 4-wire	8			1
22260744	AB-DN-DI16-M12	2, 3, 4-wire	16			1
<b>With digital outputs</b>						
22260747	AB-DN-DO8-M12-2A	2, 3-wire		8	2.0	1

Unless specified otherwise, the shown product values are nominal values. Detailed values (e.g. tolerances) are available upon request.

DeviceNet is a registered trademark of ODVA

Photographs are not to scale and do not represent detailed images of the respective products.

For the UNITRONIC® field bus type code, please see table T6

Unused female connectors must be covered with protective caps (see accessories). (M8: 22260606, M12: 22260605)

### Accessories

- Screw plug for unoccupied sockets refer to page 112
- Terminating resistor M12 for DeviceNet/CANopen/PROFIBUS refer to page 134
- S/A T-connector M12 as parallel distributor refer to page 136



**Info**

- With M12 quick-locking system, metal thread

## CANopen Modules



### Benefits

- Standardised interfaces
- For decentralised automation
- Space-saving due to compact dimensions
- Easy to install
- Fast and easy error tracking

### Application range

- Automation technology
- Mechanical engineering
- Plant engineering
- Tool shop
- Automotive industry

### Product features

- CANopen Interface
- Integration of field bus activation and input/output level
- Connection to CANopen using M12 connectors (A-coded)
- Digital inputs/outputs with M12 connection method for sensors/actuators
- LED diagnostic and status indicators
- Flexible power supply concept with M12 connection
- Short circuit/overload protection

### Norm references / Approvals

- UL File: E334209; E334210

### Suitable cables

- DeviceNet/CANopen Cable, M12 connector on free conductor end Page 131
- S/A DeviceNet/CANopen cable, M12 connector on M12 socket Page 132

### Suitable tools

- Suitable tools are available upon request (e.g. M12 torque screwdriver)

### Suitable connectors

- Field mountable S/A connectors M12 Page 113

### Technical data

**Fieldbus system**  
CANopen

**Transmission speed**  
10, 20, 50, 125, 250, 500, 1000 kBit/s  
Automatic baud rate detection

**Transmission physics**  
Copper cable with optional power supply in acc. with CAN standard

**Space allocated for address**  
1 ... 126, can be set

**Connection type**  
Bus port:  
2 x M12 connectors, A-coded

**Installation**  
Flexible mounting (wall, DIN rail)

**Number of pins**  
5

**IP** Protection rating  
IP65/IP67

**Protection class**  
Class 3 as per VDE 0106, IEC 61440

**0** Ambient temperature (operation)  
-25°C to +60°C

**Temperature (storage/transport)**  
-25 °C to +85 °C

**Permissible humidity (storage/transport)**  
95 %

**Transmission rate**  
Maximum 1 Mbaud automatic detection

**Supply voltage**  
24V DC

Article number	Article designation	Connection systems (sensor/actuator)	Number of inputs	Number of outputs	PU
<b>With digital inputs/outputs</b>					
22260750	AB-CAN-DI4DO4-M12-2A	2, 3, 4-wire	4	4	1
22260764	AB-CAN-DI8DO8-M12-0,5A	2, 3, 4-wire	8	8	1
<b>With digital inputs</b>					
22260748	AB-CAN-DI8-M12	2, 3, 4-wire	8		1
22260749	AB-CAN-DI16-M12	2, 3, 4-wire	16		1
<b>With digital outputs</b>					
22260752	AB-CAN-DO8-M12-2A	2, 3-wire		8	1

Unless specified otherwise, the shown product values are nominal values. Detailed values (e.g. tolerances) are available upon request. Photographs are not to scale and do not represent detailed images of the respective products. For the UNITRONIC® field bus type code, please see table T6. Unused female connectors must be covered with protective caps (see accessories). (M8: 22260606, M12: 22260605)

### Accessories

- Screw plug for unoccupied sockets refer to page 112
- Terminating resistor M12 for DeviceNet/CANopen/PROFIBUS refer to page 134
- S/A T-connector M12 as parallel distributor refer to page 136



## AS-Interface Distributor



**Info**

- AS-Interface Adapter for data and power supply

### Benefits

- Inexpensive and efficient wiring for AS-Interface installations
- Space-saving due to compact dimensions
- Easy to install
- Standardised interfaces

### Application range

- Automation technology
- Mechanical engineering
- Plant engineering
- Tool shop
- Automotive industry

### Product features

- Passive AS-Interface distributor for 1 or 2 AS-Interface flat cables
- Distributor with integrated M12 socket (A-coded)
- H distributor for distribution from 1 to 2 flat cables
- Distributor with round cable and M12 socket (A-coded)
- Colour: black
- Rated current  $\leq 4$  A (H-distributor:  $1 \leq 8$  A)

### Design

- Fixed flexible control cable
- Design:  $4 \times 0.34$  mm<sup>2</sup> (42 x 0.1 mm)
- Core colours: brown(1), white(2), blue(3), black(4)
- Outer sheath: PUR, halogen-free
- Outer sheath colour: black

### Suitable cables

- UNITRONIC® BUS ASI Page 49
- UNITRONIC® BUS ASI FD Page 50

### Technical data

#### Fieldbus system

AS-Interface

#### Connection type

Penetration technique for flat cable

#### Installation

Panel mounting



#### Protection rating

IP 67  
(H-distributor: IP69k)



#### Ambient temperature (operation)

-25°C to +75°C

Article number	Article designation	PU
<b>Distributor with 1 flat cable and integrated 2-pin M12 socket</b>		
22260800	AB-ASI-J-Y-N-M12FS	1
<b>Distributor with 2 flat cables and integrated 4-pin M12 socket</b>		
22260801	AB-ASI-J-Y-B-M12FS	1
<b>H distributor for distribution from 1 to 2 flat cables</b>		
22260802	AB-ASI-J-Y-Y-N	1
<b>Distributor with 1 flat cable, and 1 m PUR round cable to straight 2-pin M12 socket</b>		
22260803	AB-ASI-J-Y-N-PUR-1,0-M12FS	1
<b>Distributor with 1 flat cable, and 2 m PUR round cable to straight 2-pin M12 socket</b>		
22260804	AB-ASI-J-Y-N-PUR-2,0-M12FS	1
<b>Distributor with 2 flat cables, and 1 m PUR round cable to straight 4-pin M12 socket</b>		
22260805	AB-ASI-J-Y-B-PUR-1,0-M12FS	1
<b>Distributor with 2 flat cables, and 2 m PUR round cable to straight 4-pin M12 socket</b>		
22260806	AB-ASI-J-Y-B-PUR-2,0-M12FS	1

Unless specified otherwise, the shown product values are nominal values. Detailed values (e.g. tolerances) are available upon request.  
Copper price basis: inclusive of copper. Refer to catalogue appendix T17 for the definition and calculation of copper-related surcharges.  
Photographs are not to scale and do not represent detailed images of the respective products.  
For detailed technical information please refer to the data sheet  
For the UNITRONIC® field bus type code, please see table T6

### Accessories

- Kraftform® adjustable torque screwdriver/Kraftform Kompakt® Set





## AS-Interface counter module

**Info**

- All-purpose counter module



### Benefits

- Standardised interfaces
- Easy to install
- For fixed installation.
- Compact AS-Interface counter module for counting events, distance and speed measurement

### Application range

- Automation technology
- Mechanical engineering
- Plant engineering
- Tool shop
- Automotive industry

### Product features

- Set-point value of counter reading and pre-switching value can be parameterised via AS-Interface
- Output switching action selectable if preset value is reached
- Detect goods to be counted or measured with any 2 or 3-wire binary sensor
- AS-Interface Version 3.0
- Connection by optional screw-plug terminals or spring-plug terminals

### Technical data

- Fieldbus system**  
AS-Interface
- Connection type**  
Plug-in connection for screw-plug terminals or spring-plug terminals
- Installation**  
Top-hat rail (35 mm)
- Protection rating**  
IP 20
- Protection class**  
II
- Ambient temperature (operation)**  
-25°C to +60°C
- Supply voltage**  
according to AS-Interface specification (version 3.0)

Article number	Article designation	PU
22260810	AB-ASI-C	1

Unless specified otherwise, the shown product values are nominal values. Detailed values (e.g. tolerances) are available upon request. Plug terminals are not included, but can be purchased as an accessory. Photographs are not to scale and do not represent detailed images of the respective products.

### Accessories

- AS-Interface power supply refer to page 126



## AS-Interface power supply



### Benefits

- Easy to install
- Space-saving due to compact dimensions
- Compact AS-Interface power supply for mounting on top-hat rail

### Application range

- Automation technology
- Mechanical engineering
- Plant engineering
- Tool shop
- For small AS-Interface networks

### Product features

- Supplies a nominal output current of  $I_N = 1.0\text{ A}$
- AS-Interface Specification 3.01
- Short circuit/overload protection

### Suitable cables

- UNITRONIC® BUS ASI Page 49
- UNITRONIC® BUS ASI FD Page 50



### Info

- Compact design

### Technical data

#### Fieldbus system

AS-Interface

#### Connection type

Cage clamp termination: 0.3 - 3.5 mm<sup>2</sup>

#### Installation

Top-hat rail (35 mm)



#### Protection rating

IP 20

#### Protection class

II



#### Ambient temperature (operation)

-10°C to +60°C

#### Temperature (storage/transport)

-25 °C to +85 °C

#### Supply voltage

Primary voltage range: 85 to 265 V AC

(50/60 Hz)

AS-Interface voltage: 29.5 to 31.6 V DC

PELV (acc. to IEC61140),  $I_N = 1\text{ A}$

Article number	Article designation	PU
AS-Interface power supply		
22260812	AB-ASI-PS-1A	1

Unless specified otherwise, the shown product values are nominal values. Detailed values (e.g. tolerances) are available upon request. Photographs are not to scale and do not represent detailed images of the respective products. PELV ("protective extra low voltage" according to IEC61640)



## AS-Interface network extension

### Benefits

- Extension of AS-Interface network lengths without additional repeaters
- Every topology is possible
- Standardised interfaces
- Easy to install

### Application range

- Automation technology
- Mechanical engineering
- Plant engineering
- Tool shop
- Automotive industry

### Product features

- AS-Interface network lengths of 100 m to 200 m without repeaters
- Under-voltage limit detection (voltage threshold: app. 26.5 V) flashes if supply voltage is too low.
  - Alarm indication by flashing LED (Part: 22260813)
  - Alarm indication occurs remotely via the AS-Interface to the master (Part: 22260814)
- AS-Interface Specification 3.01
- Diameter: 20 mm; Height: 45 mm
- Can be screwed directly to AS-Interface distributor (see accessories)

### Design

- Compact design (Z plug)



#### Info

- With integrated under-voltage limit detection

### Technical data

**Fieldbus system**  
AS-Interface

**Connection type**  
M12 A-coded connectors

**Installation**  
Screw termination

**Number of pins**  
4



**Protection rating**  
IP 67



**Ambient temperature (operation)**  
-25°C to +70°C

**Supply voltage**  
according to AS-Interface specification (version 3.0)



Article number	Article designation	PU
<b>With optical voltage indication by green LED</b>		
22260813	AB-ASI-NE200LED	1
<b>With voltage control via response to the master (without LED)</b>		
22260814	AB-ASI-NE200	1

Unless specified otherwise, the shown product values are nominal values. Detailed values (e.g. tolerances) are available upon request. Photographs are not to scale and do not represent detailed images of the respective products.

### Accessories

- AS-Interface Distributor refer to page 124



## AS-Interface plug terminals



### ■ Benefits

- Easy to assemble
- Fast-connect adapter terminals
- Enables individual use as tension or screw plug terminals
- Flexible connection solutions

### ■ Application range

- Automation technology
- Mechanical engineering
- Plant engineering
- Tool shop
- Automotive industry

### ■ Product features

- Optional plug terminals for AS-Interface module IP20/IP30
- Fast-connect connection type
- 1 packing unit for 12, 16 or 32 contacts
- Black

### ■ Suitable cables

- Power cable: M 12 connector on free conductor Page 137
- UNITRONIC® BUS ASI Page 49
- UNITRONIC® BUS ASI FD Page 50

### ■ Suitable tools

- Kraftform® adjustable torque screwdriver/ Kraftform Kompakt® Set

**Info**

- Fully industrialised

### ■ Technical data

**Fieldbus system**  
AS-Interface

**Connection type**  
for cable type: solid, flexible  
- versions as screw plug terminals  
- versions as tension plug terminals

**Installation**  
Plug connection

**Number of pins**  
Versions: 3 -, 4 - and 16-pin

**IP** **Protection rating**  
IP 30

**Ambient temperature (operation)**  
-25°C to +60°C

Article number	Article designation	PU
AS-Interface screw plug terminals, 2 x 16-pin, 0.14-2.5 mm 22260815	AB-ASI-XS16	1
AS-Interface screw plug terminals, 4 x 4-pin, 0.14-2.5 mm 22260817	AB-ASI-XS4	1
AS-Interface screw plug terminals, 4 x 3-pin, 0.14-2.5 mm 22260041	AB-ASI-XS3	1
AS-Interface tension plug terminals, 8 x 4-pin, 0.2-2.5 mm 22260816	AB-ASI-XT16	1
AS-Interface tension plug terminals, 4 x 4-pin, 0.2-2.5 mm 22260818	AB-ASI-XT4	1

Unless specified otherwise, the shown product values are nominal values. Detailed values (e.g. tolerances) are available upon request. Photographs are not to scale and do not represent detailed images of the respective products.

### ■ Accessories

- AS-Interface counter module refer to page 125
- AS-Interface long distance repeater
- AS-Interface Modules (IP30) refer to page 120

ÖLFLEX®

UNITRONIC®

ETHERLINE®

HITRONIC®

EPIC®

SKINTOP®

FLEXIMARK®

APPENDIX



## PROFIBUS cable: M 12 connector on free conductor end

**Info**

- Pre-assembled PROFIBUS data network cable

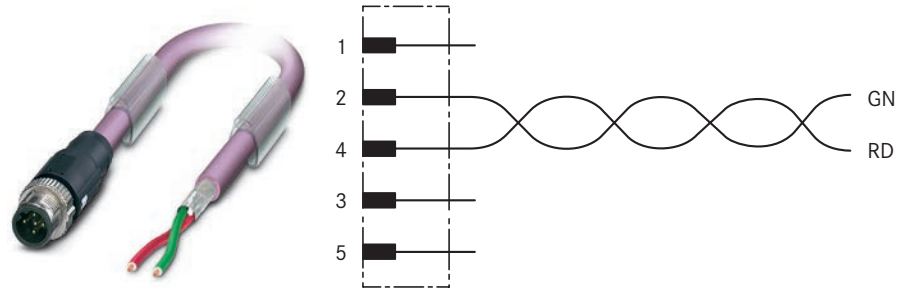

### Benefits

- Inexpensive and efficient wiring for PROFIBUS installations
- Space-saving due to compact dimensions
- Fast and easy error tracking
- Standardised interfaces

### Application range

- Automation technology
- Mechanical engineering
- Plant engineering
- Tool shop
- Automotive industry

### Product features

- 2-pole PROFIBUS cable, shielded
- 5-pin connector, M 12 B-coded (inverse) with quick locking system
- Design: socket or plug to free conductor end
- The cables have marker carriers
- Suitable for drag chains

### Design

- Fixed flexible control cable
- Design: 19 x 0.13 mm
- Core colours: red, green
- Outer sheath: PUR, halogen-free, screened
- Outer sheath colour: violet RAL 4001
- Shielding is conducted over the knurl

### Suitable connectors

- EPIC® Data Connectors Page 69
- BUS M 12 connectors that can be assembled

### Technical data

	<b>Number of pins</b>
	2
<b>IP</b>	<b>Protection rating</b> IP65/IP67/IP69K
<b>0+</b>	<b>Ambient temperature (operation)</b> Plug/socket -25°C to +90°C Cable, fixed installation -40°C to +80°C Cable, flexible installation -20°C to +80°C
	<b>Contact material</b> CuSn
	<b>Contact surface material</b> Ni/Au
	<b>Coding</b> B - inverse
	<b>Knurl material</b> Zinc die-cast, nickel-plated
	<b>Gripping body material</b> TPU, flame-retardant, self-extinguishing
	<b>Outer cable diameter</b> 7,8 mm
<b>⊘</b>	<b>Conductor cross-section</b> 0,25 mm <sup>2</sup>
	<b>Shielding</b> Tinned-copper braiding

Article number	Article designation	Length (m)	Nominal current I <sub>n</sub> in (A)	Nominal voltage U <sub>n</sub> (V)	Number of pins	PU
<b>PROFIBUS cable: M 12 connector on free conductor end</b>						
22260768	AB-PB-M 12MS-5,0PUR	5	4	250	2	1
22260769	AB-PB-M 12MS-10,0PUR	10	4	250	2	1
<b>Straight socket</b>						
22260770	AB-PB-2,0PUR-M 12FS	2	4	250	2	1
22260771	AB-PB-5,0PUR-M 12FS	5	4	250	2	1
22260772	AB-PB-10,0PUR-M 12FS	10	4	250	2	1
<b>Angled connector</b>						
22260956	AB-PB-M 12MA-2,0PUR	2	4	250	2	1
<b>Straight connector</b>						
22260767	AB-PB-M 12MS-2,0PUR	2	4	250	2	1

Unless specified otherwise, the shown product values are nominal values. Detailed values (e.g. tolerances) are available upon request.  
 Copper price basis: inclusive of copper. Refer to catalogue appendix T17 for the definition and calculation of copper-related surcharges.  
 Customised cable lengths are available upon request.  
 Photographs are not to scale and do not represent detailed images of the respective products.  
 For detailed technical information please refer to the data sheet  
 For the UNITRONIC® field bus type code, please see table T6

### Accessories

- FLEXIMARK® Label LMB





## PROFIBUS Cable: M 12 connector on M 12 socket

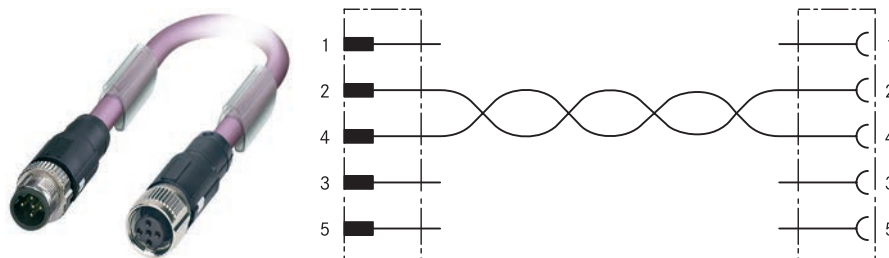

**Info**

- PROFIBUS data network cable, ready for connection

### Benefits

- Inexpensive and efficient wiring for PROFIBUS installations
- Space-saving due to compact dimensions
- Fast and easy error tracking
- Standardised interfaces

### Application range

- Automation technology
- Mechanical engineering
- Plant engineering
- Tool shop
- Automotive industry

### Product features

- 2-pole PROFIBUS cable, shielded
- 5-pin connector, M 12 B-coded (inverse) with quick locking system
- Design: plug to socket
- The cables have marker carriers
- Suitable for drag chains

### Design

- Fixed flexible control cable
- Design: 19 x 0.13 mm
- Core colours: red, green
- Outer sheath: PUR, halogen-free, screened
- Outer sheath colour: violet RAL 4001
- Shielding is conducted over the knurl

### Suitable connectors

- EPIC® Data PROFIBUS Connectors M 12 Page 73

### Technical data

**Number of pins**  
2



**Protection rating**  
IP65/IP67/IP69K



**Ambient temperature (operation)**

Plug/socket  
-25°C to +90°C  
Cable, fixed installation  
-40°C to +80°C  
Cable, flexible installation  
-20°C to +80°C

**Contact material**  
CuSn

**Contact surface material**  
Ni/Au

**Coding**  
B - inverse

**Knurl material**  
Zinc die-cast, nickel-plated

**Gripping body material**  
TPU, flame-retardant, self-extinguishing

**Outer cable diameter**  
7,8 mm



**Conductor cross-section**  
0,25 mm<sup>2</sup>

**Shielding**  
Tinned-copper braiding

Article number	Article designation	Length (m)	Nominal current I <sub>N</sub> (A)	Nominal voltage U <sub>N</sub> (V)	Number of pins	PU
<b>Straight connector to straight socket</b>						
22260955	AB-PB-M 12MS-0,2PUR-M 12FS	0.2	4	250	2	1
22260773	AB-PB-M 12MS-0,3PUR-M 12FS	0.3	4	250	2	1
22260774	AB-PB-M 12MS-1,0PUR-M 12FS	1	4	250	2	1
22260775	AB-PB-M 12MS-2,0PUR-M 12FS	2	4	250	2	1
22260776	AB-PB-M 12MS-5,0PUR-M 12FS	5	4	250	2	1
22260777	AB-PB-M 12MS-10,0PUR-M 12FS	10	4	250	2	1
22260907	AB-PB-M 12MS-15,0PUR-M 12FS	15	4	250	2	1
22260908	AB-PB-M 12MS-20,0PUR-M 12FS	20	4	250	2	1
<b>Angled plug to angled socket</b>						
22260079	AB-PB-M 12MA-5,0PUR-M 12FA	5	4	250	2	1
22260904	AB-PB-M 12MA-10,0PUR-M 12FA	10	4	250	2	1
22260905	AB-PB-M 12MA-15,0PUR-M 12FA	15	4	250	2	1

Unless specified otherwise, the shown product values are nominal values. Detailed values (e.g. tolerances) are available upon request.  
Copper price basis: inclusive of copper. Refer to catalogue appendix T17 for the definition and calculation of copper-related surcharges.  
Customised cable lengths are available upon request.  
Photographs are not to scale and do not represent detailed images of the respective products.  
For detailed technical information please refer to the data sheet  
For the UNITRONIC® field bus type code, please see table T6

### Accessories

- FLEXIMARK® Label LMB



## DeviceNet/CANopen Cable, M12 connector on free conductor end

**Info**

- Pre-assembled DeviceNet/CANopen data network cable

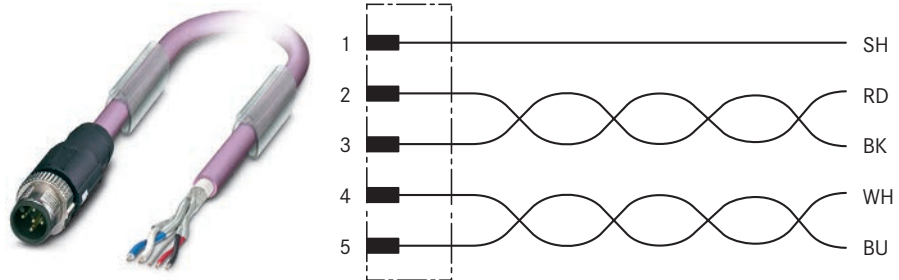

### Benefits

- Cost-effective and efficient wiring of field bus installations, sensors and actuators
- Space-saving due to compact dimensions
- Robust design
- Standardised interfaces

### Application range

- Automation technology
- Mechanical engineering
- Plant engineering
- Tool shop
- Automotive industry

### Product features

- 5-pin DeviceNet/CANopen cable, shielded
- M12 A-coded with quick-locking system
- Straight socket or straight plug to free conductor end
- The cables have marker carriers
- Suitable for drag chains

### Design

- Outer sheath: PUR, halogen-free, screened
- Fixed flexible control cable
- Design (signal line): 19 x 0.13 mm
- Design (voltage line): 19 x 0.15 mm
- Core colours: red-black, blue-white
- Outer sheath colour: violet RAL 4001

### Suitable connectors

- EPIC® Data Connectors Page 80
- Field mountable S/A connectors M12 Page 113

### Technical data

- IP Protection rating**  
IP65/IP67/IP69K
- Ambient temperature (operation)**  
Plug/socket  
-25°C to +90°C (PUR/PVC)  
Cable, fixed installation  
-40°C to +80°C  
Cable, flexible installation  
-20°C to +80°C
- Contact surface material**  
Ni/Au
- Coding**  
A-Standard
- Knurl material**  
Zinc die-cast, nickel-plated
- Gripping body material**  
TPU, flame-retardant, self-extinguishing
- Outer cable diameter**  
6,7 mm
- Conductor cross-section**  
Signal (2 x 0,2 mm<sup>2</sup>)  
Power (2 x 0,34 mm<sup>2</sup>)  
Drain wire (1 x 0,34 mm<sup>2</sup>)

Article number	Article designation	Length (m)	Nominal voltage U <sub>N</sub> (V)	Nominal current I <sub>N</sub> in (A)	Number of pins	PU
<b>5-pin straight connector</b>						
22260789	AB-DN-M12MS-2,0PUR	2	60	4	5	1
22260790	AB-DN-M12MS-5,0PUR	5	60	4	5	1
22260791	AB-DN-M12MS-10,0PUR	10	60	4	5	1
<b>5-pin straight socket</b>						
22260792	AB-DN-2,0PUR-M12FS	2	60	4	5	1
22260793	AB-DN-5,0PUR-M12FS	5	60	4	5	1
22260794	AB-DN-10,0PUR-M12FS	10	60	4	5	1

Unless specified otherwise, the shown product values are nominal values. Detailed values (e.g. tolerances) are available upon request.  
Copper price basis: inclusive of copper. Refer to catalogue appendix T17 for the definition and calculation of copper-related surcharges.  
Customised cable lengths are available upon request.  
Photographs are not to scale and do not represent detailed images of the respective products.  
For detailed technical information please refer to the data sheet  
For the UNITRONIC® field bus type code, please see table T6

### Accessories

- FLEXIMARK® Label LMB



## S/A DeviceNet/CANopen cable, M12 connector on M12 socket

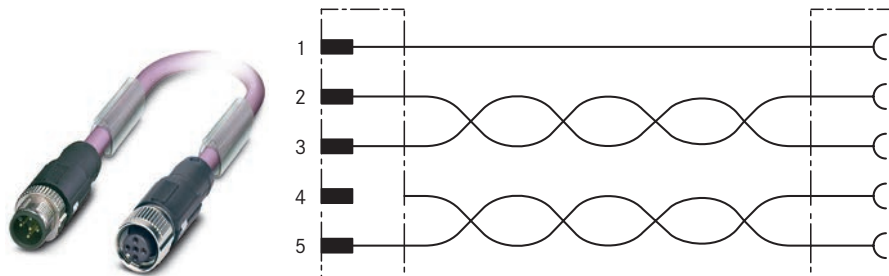

**Info**

- DeviceNet/CANopen data network cable, ready for connection

**Benefits**

- Cost-effective and efficient wiring of field bus installations, sensors and actuators
- Space-saving due to compact dimensions
- Fast and easy error tracking
- Standardised interfaces

**Application range**

- Automation technology
- Mechanical engineering
- Plant engineering
- Tool shop
- Automotive industry

**Product features**

- 5-pin DeviceNet/CANopen cable, shielded
- M12 A-coded with quick-locking system
- Straight plug to straight socket
- The cables have marker carriers
- Suitable for drag chains

**Design**

- Outer sheath: PUR, halogen-free, screened
- Fixed flexible control cable
- Design (signal line): 19 x 0.13 mm
- Design (voltage line): 19 x 0.15 mm
- Core colours: red-black, blue-white
- Outer sheath colour: violet RAL 4001

**Technical data**

**IP** Protection rating  
IP65/IP67/IP69K

**0+T** Ambient temperature (operation)  
Plug/socket  
-25°C to +90°C (PUR/PVC)  
Cable, fixed installation  
-40°C to +80°C  
Cable, flexible installation  
-20°C to +75°C

**Contact surface material**  
Ni/Au

**Coding**  
A-Standard

**Knurl material**  
Zinc die-cast, nickel-plated

**Gripping body material**  
TPU, flame-retardant, self-extinguishing

**Outer cable diameter**  
6,7 mm

**Conductor cross-section**  
Signal (2 x 0,2 mm<sup>2</sup>)  
Power (2 x 0,34 mm<sup>2</sup>)  
Drain wire (1 x 0,34 mm<sup>2</sup>)

Article number	Article designation	Length (m)	Nominal voltage U <sub>N</sub> (V)	Nominal current I <sub>N</sub> in (A)	Number of pins	PU
<b>Straight connector to straight socket</b>						
22260795	AB-DN-M12MS-0,3PUR-M12FS	0,3	60	4	5	1
22260796	AB-DN-M12MS-1,0PUR-M12FS	1	60	4	5	1
22260797	AB-DN-M12MS-2,0PUR-M12FS	2	60	4	5	1
22260798	AB-DN-M12MS-5,0PUR-M12FS	5	60	4	5	1
22260799	AB-DN-M12MS-10,0PUR-M12FS	10	60	4	5	1

Unless specified otherwise, the shown product values are nominal values. Detailed values (e.g. tolerances) are available upon request.  
 DeviceNet is a registered trademark of ODVA  
 Customised cable lengths are available upon request.  
 Photographs are not to scale and do not represent detailed images of the respective products.  
 For detailed technical information please refer to the data sheet  
 For the UNITRONIC® field bus type code, please see table T6



## BUS M12 connectors that can be assembled

**Info**

- For
  - PROFIBUS
  - CANopen
  - DeviceNet
  - PROFINET
  - ETHERNET



### Benefits

- Quick and easy on-site assembly
- Creating individual cable lengths
- Inexpensive and efficient wiring for BUS installations
- Space-saving due to compact dimensions
- Standardised interfaces

### Application range

- Automation technology
- Mechanical engineering
- Plant engineering
- Tool shop
- Automotive industry

### Product features

- Screened version
- For CANopen/DeviceNet applications (A-coded)
- For PROFIBUS applications (B-inverse coded)
- For PROFINET applications (D-coded)
- For Ethernet applications (D-coded)

### Suitable cables

- Cables for bus systems PROFIBUS-DP/FMS/FIP Page 51
- Cables for bus system CAN UL/CSA-approved Page 78
- Cables for bus system DeviceNet Page 76
- PROFIBUS cable: M12 connector on free conductor end Page 129
- ETHERLINE® 2-pairs CAT.5/5e

### Technical data

<b>Number of pins</b>	5 (PROFIBUS/CANopen/DeviceNet) 4 (PROFINET/ETHERNET)
<b>Protection rating</b>	IP67
<b>Ambient temperature (operation)</b>	Plug/socket -40°C to +85°C
<b>Contact material</b>	CuSn
<b>Contact surface material</b>	Au (PROFIBUS/CANopen/DeviceNet) Ni/Au (PROFINET/ETHERNET)
<b>Coding</b>	A - CANopen/DeviceNet B - inverse (PROFIBUS) D - data (PROFINET/ETHERNET)
<b>Knurl material</b>	Nickel-plated brass
<b>Gripping body material</b>	Zinc die-cast, nickel-plated
<b>Sealing material</b>	NBR (PROFIBUS/CANopen/DeviceNet) Neoprene (PROFINET/ETHERNET)
<b>Contact carrier material</b>	PA 66
<b>Nominal voltage U<sub>N</sub></b>	60 V
<b>Nominal current I<sub>N</sub></b>	4 A (PROFIBUS/CANopen/DeviceNet) 1,75 A (PROFINET/ETHERNET)
<b>PG screw connection</b>	PG 9 (PROFIBUS/CANopen/DeviceNet)

Article number	Article designation	Min. conductor cross-section, flexible, in mm <sup>2</sup>	Max. conductor cross-section, flexible, in mm <sup>2</sup>	Min. conductor cross-section AWG/kcmil	Max. conductor cross-section AWG/kcmil	Min. cable diameter (mm)	Max. cable diameter (mm)	PU
<b>PROFIBUS, 5-pin straight connector, screw connection</b>								
22260653	AB-C5-M12MSB-PG9-SH-AU	0.25	0.75	24	18	6	8.5	1
<b>PROFIBUS, 5-pin straight socket, screw connection</b>								
22260646	AB-C5-M12FSB-PG9-SH-AU	0.25	0.75	24	18	6	8.5	1
<b>PROFINET/ETHERNET, 4-pin straight connector, fast-connection</b>								
22260820	AB-C4-M12MSD-SH	0.14	0.34	26	22	4	8	1
22261016	AB-C4-M12FSD-SH	0.14	0.34	26	22	4	8	1
<b>CANopen/DeviceNet, 5-pin straight connector, screw connection</b>								
22260135	AB-C5-M12MS-PG9-SH	0.25	0.75	24	18	6	8	1
<b>CANopen/DeviceNet, 5-pin straight socket, screw connection</b>								
22260136	AB-C5-M12FS-PG9-SH	0.25	0.75	24	18	6	8	1

Unless specified otherwise, the shown product values are nominal values. Detailed values (e.g. tolerances) are available upon request.  
 DeviceNet is a registered trademark of ODVA.  
 Photographs are not to scale and do not represent detailed images of the respective products.



## Terminating resistor M 12 for DeviceNet/CANopen/PROFIBUS



**Info**

- Fully industrialised

### Benefits

- Inexpensive termination of BUS cables
- Space-saving due to compact dimensions
- Robust design
- Standardised interfaces

### Application range

- Automation technology
- Mechanical engineering
- Plant engineering
- Tool shop
- Automotive industry

### Product features

- For DeviceNet und CANopen applications (A-Standard coded)
- For PROFIBUS applications (B-inverse coded)

### Design

- Straight connector M12 with integrated termination resistor
- Straight connector M12 shielded, with integrated termination resistor

### Technical data

- IP** Protection rating  
IP65/IP67/IP69K  
IP 67 (shielded version)
- 0+** Ambient temperature (operation)  
-25°C to +90°C (unshielded version)  
-40°C to +85°C (shielded version)
- Contact material**  
CuSn
- Coding**  
B - inverse (PROFIBUS)  
A - CANopen/DeviceNet

Article number	Article designation	Nominal current $I_N$ in (A)	Nominal voltage $U_N$ (V)	Coding	Number of pins	PU
<b>For PROFIBUS applications (B-inverse coded)</b>						
22260722	AB-C4-M12MS-PB-TR	4	60	B - inverse	4	5
<b>For PROFIBUS applications (B-inverse coded, socket, shielded version)</b>						
22261001	AB-C5-M12FS-PB-TR-SH	4	32	B - inverse	4	1
<b>For DeviceNet und CANopen applications (A-Standard coded)</b>						
22260766	AB-C5-M12MS-DN-TR	4	60	A-Standard	5	5

Unless specified otherwise, the shown product values are nominal values. Detailed values (e.g. tolerances) are available upon request.  
 DeviceNet is a registered trademark of ODVA  
 Photographs are not to scale and do not represent detailed images of the respective products.  
 For detailed technical information please refer to the data sheet  
 For the UNITRONIC® field bus type code, please see table T6

### Accessories

- M12 T distributor for PROFIBUS refer to page 135
- S/A T-connector M12 as parallel distributor refer to page 136





## M 12 T distributor for PROFIBUS

**Info**

- Fully industrialised

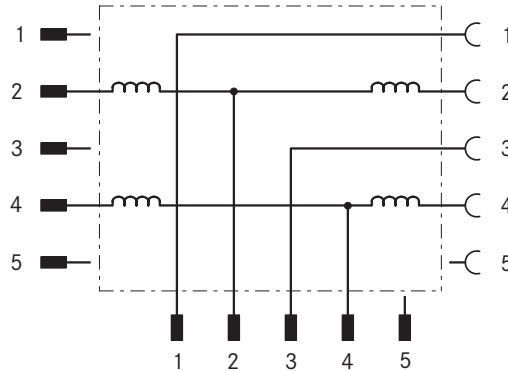

### Benefits

- Inexpensive and efficient wiring for PROFIBUS installations
- Space-saving due to compact dimensions
- Robust design
- Standardised interfaces

### Application range

- Automation technology
- Mechanical engineering
- Plant engineering
- Tool shop
- Automotive industry

### Product features

- 4-pin PROFIBUS T-connector
- M12 B-coded (inverse)
- Screened version
- M12 plug to M12 plug and M12 socket
- For PROFIBUS stubs

### Technical data

<b>IP</b>	<b>Protection rating</b> IP 67
<b>0+</b>	<b>Ambient temperature (operation)</b> Plug/socket -25°C to +80°C
	<b>Contact material</b> Copper alloy
	<b>Contact surface material</b> Ni/Au
	<b>Coding</b> B - inverse
	<b>Knurl material</b> Nickel-plated brass
	<b>Gripping body material</b> PUR
	<b>Sealing material</b> VITON®
	<b>Contact carrier material</b> PUR
	<b>Nominal voltage U<sub>N</sub></b> 60 V
	<b>Nominal current I<sub>N</sub></b> 4 A

Article number	Article designation	Nominal current I <sub>N</sub> in (A)	Nominal voltage U <sub>N</sub> (V)	Number of pins	PU
<b>M 12 T distributor for PROFIBUS</b>					
22260761	AB-C2-M12T-2XM12FS PB	4	30	4	1

Unless specified otherwise, the shown product values are nominal values. Detailed values (e.g. tolerances) are available upon request. Photographs are not to scale and do not represent detailed images of the respective products. For detailed technical information please refer to the data sheet. For the UNITRONIC® field bus type code, please see table T6

### Accessories

- Terminating resistor M12 for DeviceNet/CANopen/PROFIBUS refer to page 134



## S/A T-connector M 12 as parallel distributor

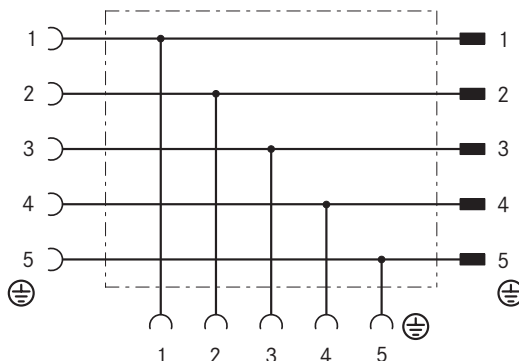

**Info**

- For DeviceNet and CANopen!

### Benefits

- Cost-effective and efficient wiring of field bus installations, sensors and actuators
- Space-saving due to compact dimensions
- Robust design
- Standardised interfaces

### Application range

- Automation technology
- Mechanical engineering
- Plant engineering
- Tool shop
- Automotive industry

### Product features

- 5-pin DeviceNet/CANopen T-Connector
- M12 A-coded
- Parallel distributor with M12 socket to M12 plug and M12 socket
- Free of paint-wetting impairment substances

### Technical data

	<b>Number of pins</b>	5
	<b>Protection rating</b>	IP65/IP67
	<b>Ambient temperature (operation)</b>	Plug/socket -25°C to +90°C
	<b>Contact material</b>	CuZn
	<b>Contact surface material</b>	Ni/Au
	<b>Coding</b>	A-Standard
	<b>Knurl material</b>	Zinc die-cast, nickel-plated
	<b>Gripping body material</b>	TPU, flame-retardant, self-extinguishing
	<b>Sealing material</b>	NBR
	<b>Contact carrier material</b>	TPU GF
	<b>Nominal voltage U<sub>N</sub></b>	60 V
	<b>Nominal current I<sub>N</sub></b>	4 A

Article number	Article designation	Nominal current I <sub>N</sub> in (A)	Nominal voltage U <sub>N</sub> (V)	Number of pins	PU
<b>S/A T-connector M 12 as parallel distributor</b>					
22260765	AB-C5-M12T-2XM12FS DN	4	60	5	5

Unless specified otherwise, the shown product values are nominal values. Detailed values (e.g. tolerances) are available upon request.  
 DeviceNet is a registered trademark of ODVA.  
 Photographs are not to scale and do not represent detailed images of the respective products.  
 For detailed technical information please refer to the data sheet  
 For the UNITRONIC® field bus type code, please see table T6

### Accessories

- Terminating resistor M 12 for DeviceNet/CANopen/PROFIBUS refer to page 134



## Power cable: M 12 connector on free conductor

**Info**

- All-purpose



### Benefits

- Cost-effective and efficient wiring of field bus installations, sensors and actuators
- Space-saving due to compact dimensions
- Customise the construction on the free conductor end
- Standardised interfaces

### Application range

- Automation technology
- Mechanical engineering
- Plant engineering
- Tool shop
- Automotive industry

### Product features

- 4-pin power cable for field bus applications
- M 12 A-coded with quick-locking system
- Straight plug or straight socket to free conductor end
- The cables have marker carriers
- Suitable for drag chains

### Design

- Fixed flexible control cable
- Design: 4 x 0.75 mm<sup>2</sup> (42 x 0.15 mm)
- Core colours: brown(1), white(2), blue(3), black(4)
- PVC core insulation
- PUR outer sheath

### Suitable connectors

- Field mountable S/A connectors M 12  
Page 113

### Technical data

	<b>Protection rating</b> IP65/IP67/IP68
	<b>Ambient temperature (operation)</b> Plug/socket -25°C to +90°C (PUR/PVC) Cable, fixed installation -25°C to +80°C Cable, flexible installation -5°C to +80°C
	<b>Contact material</b> CuSn
	<b>Contact surface material</b> Ni/Au
	<b>Coding</b> A-Standard
	<b>Knurl material</b> Zinc die-cast, nickel-plated
	<b>Gripping body material</b> TPU, flame-retardant, self-extinguishing
	<b>Core colour</b> brown (1), white (2), blue (3), black (4)
	<b>Outer cable diameter</b> 5,9 mm
	<b>Conductor cross-section</b> 0,75 mm <sup>2</sup>
	<b>Outer sheath, colour</b> Black, RAL 9005
	<b>Outer sheath, material</b> PUR

Article number	Article designation	Length (m)	Nominal current I <sub>N</sub> in (A)	Nominal voltage U <sub>N</sub> (V)	Number of pins	PU
<b>4-pin straight connector</b>						
22260778	AB-PC4-M12MS-2,0PUR	2	4	250	4	1
22260779	AB-PC4-M12MS-5,0PUR	5	4	250	4	1
22260780	AB-PC4-M12MS-10,0PUR	10	4	250	4	1
<b>4-pin straight socket</b>						
22260781	AB-PC4-2,0PUR-M12FS	2	4	250	4	1
22260782	AB-PC4-5,0PUR-M12FS	5	4	250	4	1
22260783	AB-PC4-10,0PUR-M12FS	10	4	250	4	1

Unless specified otherwise, the shown product values are nominal values. Detailed values (e.g. tolerances) are available upon request.  
Copper price basis: inclusive of copper. Refer to catalogue appendix T 17 for the definition and calculation of copper-related surcharges.  
Customised cable lengths, outer-sheath materials (e.g. PVC), and types of connectors are available upon request.  
Photographs are not to scale and do not represent detailed images of the respective products.  
For the UNITRONIC® field bus type code, please see table T6

### Accessories

- FLEXIMARK® Label LMB

**UNITRONIC® Fieldbus**

Power cable M12 (A-coded)



## Power cable: straight M12 connector on straight M12 socket

**Info**

- All-purpose



**Benefits**

- Cost-effective and efficient wiring of field bus installations, sensors and actuators
- Space-saving due to compact dimensions
- Fast and easy assembly
- Standardised interfaces

**Application range**

- Automation technology
- Mechanical engineering
- Plant engineering
- Tool shop
- Automotive industry

**Product features**

- 4-pin power cable for field bus applications
- M12 A-coded with quick-locking system
- Straight plug to straight socket
- Free of paint-wetting impairment substances
- Suitable for drag chains

**Design**

- Fixed flexible control cable
- Design: 4 x 0.75 mm<sup>2</sup> (42 x 0.15 mm)
- Core colours: brown(1), white(2), blue(3), black(4)
- PVC core insulation
- PUR outer sheath

**Technical data**

<b>IP</b>	<b>Protection rating</b> IP65/IP67/IP68
	<b>Ambient temperature (operation)</b> Plug/socket -25°C to +90°C (PUR/PVC) Cable, fixed installation -25°C to +80°C Cable, flexible installation -5°C to +80°C
	<b>Contact material</b> CuSn
	<b>Contact surface material</b> Ni/Au
	<b>Coding</b> A-Standard
	<b>Knurl material</b> Zinc die-cast, nickel-plated
	<b>Gripping body material</b> TPU, flame-retardant, self-extinguishing
	<b>Outer cable diameter</b> 5,9 mm
	<b>Conductor cross-section</b> 0,75 mm <sup>2</sup>
	<b>Outer sheath, colour</b> Black, RAL 9005
	<b>Outer sheath, material</b> PUR

Article number	Article designation	Length (m)	Nominal current I <sub>N</sub> (A)	Nominal voltage U <sub>N</sub> (V)	Number of pins	PU
<b>Straight connector to straight socket</b>						
22260784	AB-PC4-M12MS-0,3PUR-M12FS	0.3	4	250	4	1
22260785	AB-PC4-M12MS-1,0PUR-M12FS	1	4	250	4	1
22260786	AB-PC4-M12MS-2,0PUR-M12FS	2	4	250	4	1
22260787	AB-PC4-M12MS-5,0PUR-M12FS	5	4	250	4	1
22260788	AB-PC4-M12MS-10,0PUR-M12FS	10	4	250	4	1

Unless specified otherwise, the shown product values are nominal values. Detailed values (e.g. tolerances) are available upon request.  
 Copper price basis: inclusive of copper. Refer to catalogue appendix T17 for the definition and calculation of copper-related surcharges.  
 Customised cable lengths, outer-sheath materials (e.g. PVC), and types of connectors are available upon request.  
 Photographs are not to scale and do not represent detailed images of the respective products.  
 For detailed technical information please refer to the data sheet  
 For the UNITRONIC® field bus type code, please see table T6

**Accessories**

- FLEXIMARK® Label LMB

ÖLFLEX®  
 UNITRONIC®  
 ETHERLINE®  
 HITRONIC®  
 EPIC®  
 SKINTOP®  
 FLEXIMARK®  
 APPENDIX

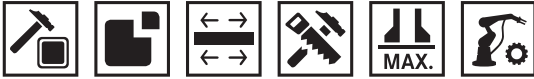

**New**

## Field mountable M12 POWER connectors

**Info**

- DC high-power connector - 60 VDC / 12 A



### Benefits

- Compact and standardized M12 design saves costs
- Fault proof connection through M12 T coding of the connector face
- Low voltage drop
- High flexibility through on-site assembly
- Safety use in field environment by high protection class

### Application range

- Automation technology
- Plant engineering, machinery manufacturing
- Tool shop
- Wiring of machines, tools, devices, appliances and control cabinets
- Suitable for use in measuring, control and regulating circuits

### Product features

- Robust M12 circular connector with screw connection and knurled screw
- Screw-locking connection, to be connected to different conductor
- For cable outer diameter 8 - 10 mm
- 60 VDC / 12 A
- Contacts: 4

### Suitable cables

- ÖLFLEX® FD 855 P
- (ÖLFLEX® FD 855 P: Example for harsh conditions)

### Technical data

<b>IP</b>	<b>Protection rating</b> IP67
<b>0+</b>	<b>Ambient temperature (operation)</b> Plug/socket -40°C to +85°C (derating must be observed - see data sheet)
	<b>Contact material</b> CuZn (brass)
	<b>Contact surface material</b> Au (gold)
	<b>Coding</b> M12 T - Power
	<b>Knurl material</b> CuZn (brass)
	<b>Gripping body material</b> PA
	<b>Outer cable diameter</b> 8 - 10 mm
	<b>Conductor cross-section</b> Conductor cross section 0.75 mm <sup>2</sup> - 1.5 mm <sup>2</sup> (AWG 18 - AWG 16)

Article number	Article designation	Number of pins	Min. cable diameter (mm)	Max. cable diameter (mm)	Nominal voltage U <sub>N</sub> (V)	Nominal current I <sub>N</sub> in (A)	PU
<b>Straight connector, screw connection, M12 (T-coded)</b>							
22262010	AB-C4-M12MST-PG11	4	8.0	10.0	60	12	1
<b>Angled connector, screw connection, M12 (T-coded)</b>							
22262012	AB-C4-M12MAT-PG11	4	8.0	10.0	60	12	1
<b>Straight socket, screw connection, M12 (T-coded)</b>							
22262011	AB-C4-M12FST-PG11	4	8.0	10.0	60	12	1
<b>Angled socket, screw connection, M12 (T-coded)</b>							
22262013	AB-C4-M12FAT-PG11	4	8.0	10.0	60	12	1

Unless specified otherwise, the shown product values are nominal values. Detailed values (e.g. tolerances) are available upon request. Photographs are not to scale and do not represent detailed images of the respective products.



**UNITRONIC® Fieldbus**

M12 POWER-Connector (T-coded)



**New**

## M12 POWER panel mount connectors for front mounting



Info

- DC high-power connector - 60 VDC / 12 A

**Benefits**

- Compact and standardized M12 design saves costs
- Fault proof connection through M12 T coding of the connector face
- Low voltage drop
- Individual solutions in the field of M12 power supply
- Safety use in field environment by high protection class

**Application range**

- Automation technology
- Plant engineering, machinery manufacturing
- Tool shop
- Wiring of machines, tools, devices, appliances and control cabinets
- Suitable for use in measuring, control and regulating circuits

**Product features**

- M12 flush-type for front wall-mounting
- 2 various designs:
  - panel mount connector M20 (with screw clamp, position adjustable)
  - panel mount connector M16 (with connected 0.2 m PVC single wire)
- Contacts: 4
- 60 VDC / 12 A
- Contact durability: > 100

**Design**

- Valid for version with connected PVC single wire:
- Tinned-copper litz wires
- Design: 4 x AWG 16 (42 x 0.203 mm)
- Core insulation made of PVC
- No outer sheath

**Suitable cables**

- MULTI-STANDARD SC 2.1
- (MULTI-STANDARD SC 2.1.: Example for panel mount connectors with screw terminals)

**Suitable connectors**

- Field mountable M12 POWER connectors Page 139

**Technical data**



**Protection rating**  
IP67



**Ambient temperature (operation)**

Plug/socket  
-40°C to +85°C  
(derating must be observed - see data sheet)  
Cable, fixed installation  
-40°C to +90°C  
(valid for design with connected PVC single wire)

**Contact material**  
CuZn (brass)

**Contact surface material**  
Au (gold)

**Coding**  
M12 T - Power

**Core colour**  
brown (1), white (2), blue (3), black (4)  
(for panel mount connectors with connected single wire):

**AWG**  
- PVC litz wire: AWG 16



**Conductor cross-section**  
For screw clamp:  
0.75 mm<sup>2</sup> - 1.5 mm<sup>2</sup>  
(AWG 18 - AWG 16)

Article number	Article designation	Number of pins	Nominal voltage U <sub>N</sub> (V)	Nominal current I <sub>N</sub> in (A)	PU
<b>M12 panel mount connector (male) with screw clamp, front mounting (thread: M20 x 1,5)</b>					
22262014	AB-C4-M12MST-M20-PO	4	60	12	1
<b>M12 panel mount connector (socket) with screw clamp, front mounting (thread: M20 x 1,5)</b>					
22262015	AB-C4-M12FST-M20-PO	4	60	12	1
<b>M12 panel mount connector (male) with assembled PVC single wires, l = 0.2 m, front mounting (thread: M16 x 1,5)</b>					
22262016	AB-C4-M12MST-M16-0,2	4	60	12	1
<b>M12 panel mount connector (socket) with assembled PVC single wires, l = 0.2 m, front mounting (thread: M16 x 1,5)</b>					
22262017	AB-C4-M12FST-M16-0,2	4	60	12	1

Unless specified otherwise, the shown product values are nominal values. Detailed values (e.g. tolerances) are available upon request.  
Other designs and lengths are available upon request.  
Photographs are not to scale and do not represent detailed images of the respective products.  
M16 or M20 locknuts not included in delivery

**Accessories**

- SKINDICHT® SM-M refer to page 270



**ETHERLINE®**

Data communication systems for ETHERNET technology



# ETHERNET in Automation

## ETHERNET in Automation

The Ethernet standard is a permanent fixture in corporate IT departments due to its simplicity. The reason for the acceptance and popularity is not only because of the integrated networking for a company, but rather due to the fact that it is the basic technology for the world's largest network – the Internet. The Ethernet is the world's most-used standard. The advantages of the Ethernet and the related networking are obvious:

- Simple, unlimited expansion possibilities
- Fast assembly due to simple connection technology with RJ45 or M12
- Dynamic bandwidth adjustment with 10/100 Mbit/s, 1 Gbit up to a current 10 Gbit/s
- Connecting of various applications areas (industrial, building, Automation, IT, ...)

Because of these facts, more companies are using the performance of Ethernet for their machine and plant control. For these applications, the Industrial Ethernet Systems are developed. Now it is possible to connect your office area with the industrial field area. Due to the fact, that Ethernet allows to use one communication system through all areas, need only less interfaces and can connect unlimited numbers of members, it offers the applicants for example the possibility to use remote diagnostics via the Internet. Industrial Ethernet systems like EtherCAT®, PROFINET® or EtherNet/IP® are especially developed for industrial applications. In combination of using Ethernet protocols and components which are specified for industrial environment, there are more advantages than for commercial fieldbus systems like PROFIBUS:

- Company-wide access to data and applications
- High data transmission rate for fast exchange of information
- Improvement of efficiency and speed of work flow and furthermore an increase of energy efficiency and machine performance
- Continuously and coordinated monitoring and machine control for an optimized manufacturing process
- Wiring from office till machine is possible

The user can choose between copper cable (Twisted Pair-cable), fiber optics or wireless for physical connection of the devices. There are different maximum transmission length for the media.

### ETHERNET in Automation

ETHERNET in Automation .....	142
Quickfinder .....	143
Industrial Ethernet patchcords .....	147
PROFINET® .....	149
Connectors .....	150
ETHERLINE® Article Code .....	151

<b>Product Pages</b> .....	<b>153</b>
----------------------------	------------

For current information see [www.lappgroup.com/products](http://www.lappgroup.com/products)

	Medium	Cable	Installation length
ETHERNET	10 Base-T	Twisted Pair	100 m
	10 Base-FL	62.5 µm, 50 µm Multimode LWL	2.000 m
Fast ETHERNET	100 Base-TX	Twisted Pair	100 m
	100 Base-FX	62.5 µm, 50 µm Multimode LWL FDX	412 m
		62.5 µm, 50 µm Multimode LWL HDX	2.000 m
Gigabit ETHERNET	1000 Base-CX	Twinax STP (150 Ohm)	25 m
	1000 Base-T	Twisted Pair	100 m
		62.5 µm Multimode LWL	275 m
	1000 Base-SX 850 nm	50 µm Multimode LWL	550 m
		62.5 µm Multimode LWL	550 m
		50 µm Multimode LWL	550 m
1000 Base-LX 1300 nm	Singlemode LWL	5.000 m	
10 Gigabit ETHERNET	10G Base-T	Twisted Pair	100 m
	10G Base-LX4 WWDM	Singlemode LWL	10.000 m
	10G Base-LX4 WWDM	Multimode LWL	300 m
	10G Base-SR/SW 850 nm	62.5 µm Multimode LWL	26 m
		50 µm Multimode LWL	82 m
	10G Base-LR/LW 850 nm	Singlemode LWL	10.000 m
10G Base-ER/EW 1550 nm	Singlemode LWL	40.000 m	

## Quickfinder

Automation area	Inst. area	Category	Application/cabling	halogen-free	Sheath material	Shielding (standard description)	AWG	Outer diameter [mm]	Characteristics	Approvals	Article designation	Article number	Page	Connectors	Socket (SnapIn)		
Building 4-pairs	indoor	Cat.5e	static	x	LSZH	U/UTP	4x2xAWG24/1	5.6			UNITRONIC® LAN 200 U/UTP Cat.5e LSZH	2170173	*	3,4,5,8	20,24,27,28		
						SF/UTP	4x2xAWG24/1	6.7			UNITRONIC® LAN 200 SF/UTP Cat.5e LSZH	2170138	*	4,5,8	20,24,27,28		
			flexible	PVC	F/UTP	4x2xAWG24/1	5.6			UNITRONIC® LAN 200 U/UTP Cat.5e Y	2170125	*	3,4,5,8	20,24,27,28			
					F/UTP	4x2xAWG24/1	6.4			UNITRONIC® LAN 200 F/UTP Cat.5e Y	2170126	*	3,4,5,8	20,24,27,28			
					SF/UTP	4x2xAWG24/1	6.7			UNITRONIC® LAN 200 SF/UTP Cat.5e Y	2170128	*	4,5,8	20,24,27,28			
		flexible	PVC	F/UTP	4x2xAWG26/7	5.6			UNITRONIC® LAN 200 F/UTP Cat.5e Y Flex	2170127	*	1,2,3,4,5,8	21,23,27,28				
				SF/UTP	4x2xAWG26/7	6			UNITRONIC® LAN 200 SF/UTP Cat.5e Y Flex	2170129	*	1,2,3,4,5,8	21,23,27,28				
				F/UTP	4x2xAWG26/7	5.6			UNITRONIC® LAN 200 F/UTP Cat.5e H Flex	2170172	*	1,2,3,4,5,8	21,23,27,28				
		flexible	LSZH	x	SF/UTP	4x2xAWG26/7	6		UNITRONIC® LAN 200 SF/UTP Cat.5e H Flex	2170139	*	1,2,3,4,5,8	21,23,27,28				
		Cat.6	static	x	LSZH	U/UTP	4x2xAWG24/1	6.5				UNITRONIC® LAN 250 U/UTP Cat.6 LSZH	2170171	*	5,8	22,24,25,26,27,28	
						F/UTP	4x2xAWG24/1	7.5			UNITRONIC® LAN 250 F/UTP Cat.6 LSZH	2170170	*	5,8	22,24,25,26,27,28		
		Cat.6	static	PVC	x	LSZH	U/UTP	4x2xAWG24/1	6.5				UNITRONIC® LAN 250 U/UTP Cat.6 Y	2170186	*	5,8	22,24,25,26,27,28
							F/UTP	4x2xAWG24/1	7.4			UNITRONIC® LAN 500 U/FTP Cat.6 LSZH	2170195	*	5,8	24,25,26,27,28	
		Cat.6 <sub>A</sub>	static	x	LSZH	F/FTP	4x2xAWG23/1	7.6					UNITRONIC® LAN 500 F/FTP Cat.6 LSZH	2170196	*	5,8	24,25,26,27,28
						S/FTP	4x2xAWG23/1	7.1			UNITRONIC® LAN 500 S/FTP Cat.6 Y	2170143	*	5,8	24,25,26,27,28		
	Cat.7	static	x	LSZH	S/FTP	4x2xAWG23/1	7.7					UNITRONIC® LAN 1000 S/FTP Cat.7 LSZH	2170614	*	5,8	24,25,26,27,28,29	
					2x(4x2xAWG23/1)	2x7.7	DUPLEX			UNITRONIC® LAN 1000 S/FTP Cat.7 LSZH D	2170634	*	5,8	24,25,26,27,28,29			
Cat.7	flexible	x	PVC	S/FTP	4x2xAWG26/7	6.5					UNITRONIC® LAN 600 S/FTP Cat.7 Y FLEX	2170144	*	3,4,5,8	23,25,26,27,28		
				S/FTP	4x2xAWG26/7	6.5			UNITRONIC® LAN 600 S/FTP Cat.7 LSZH Flex	2170142	*	3,4,5,8	23,25,26,27,28				
Cat.7 <sub>A</sub>	static	x	LSZH	S/FTP	4x2xAWG22/1	8.1					UNITRONIC® LAN 1200 S/FTP Cat.7 LSZH	2170615	*	5,8	24,25,26,27,28,29		
				2x(4x2xAWG22/1)	2x8.1	DUPLEX			UNITRONIC® LAN 1200 S/FTP Cat.7 <sub>A</sub> DUPLEX	2170618	*						
Cat.7 <sub>A</sub>	static	x	LSZH	S/FTP	4x2xAWG22/1	8.5					UNITRONIC® LAN 1500 S/FTP Cat.7 LSZH	2170199	*	5,8	24,25,26,27,28,29		
outdoor ground	Cat.7	static			(L)PE	S/FTP	4x2xAWG23/1	10	PE-AL-outer sheath, direct burial		UNITRONIC® LAN 1000 S/FTP Cat.7 (L)PE	2170198	*				
					PE	S/FTP	4x2xAWG23/1	9.6	PE-outer sheath		UNITRONIC® LAN 1000 S/FTP Cat.7 PE	2170197	*				

Automation area	Inst. area	Category	Application/cabling	halogen-free	Sheath material	Shielding (standard description)	AWG	Outer diameter [mm]	Industrial Ethernet Systems	Characteristics	Approvals	Article designation	Article number	Page	Connectors	Socket (SnapIn)	
Industrial 2-pairs	indoor	Cat.5e	static	x	H	SF/UTP	2x2xAWG24/1	6.1				ETHERLINE® H Cat.5e	2170280	153	4,5,7,8,10,11	12,20,22,25,26,28	
					PVC	SF/UTP	2x2xAWG22/1	6.8	PROFINET®, EtherCAT®	QP, Fast Connect	UL/CSA Typ PLTC ER	ETHERLINE® TRAY ER PN Y FC	2170879	158	4,5,8,11,13,14,15	12,17,20,22,25,26,28	
			flexible	PVC	SF/UTP	2x2xAWG22/1	6.5	PROFINET®, EtherCAT®	QP	UL/CSA Typ CMX	ETHERLINE® PN Cat.5e Y	2170891	158	4,5,8,11,13,14,15	12,17,20,22,25,26,28		
					SF/UTP	1x4xAWG26/7	4.8	EtherCAT®	QP	UL/CSA Typ CMX	ETHERLINE® Y EC FLEX Cat.5e	2170430	169	4,5,6,7,8,9,10,11,15	12,17,20,22,25,26,28		
					SF/UTP	1x4xAWG26/7	4.8	EtherCAT®	QP	UL/CSA Typ CMX	ETHERLINE® P EC FLEX Cat.5e	2170431	169	4,5,6,7,8,9,10,11,15	12,17,20,22,25,26,28		
		flexible	x	H	S/UTP	2x2xAWG26/7	5.9						ETHERLINE® H Flex Cat.5e	2170283	154	1,2,4,5,8,10,11,15	12,21,23,25,26,28
					S/UTP	2x2xAWG26/19	6.2		power chain	UL (AWM) 1000 V Rating	ETHERLINE® FD P Cat.5e	2170289	155	4,5,6,7,8,9,10,11,15	12,21,23,25,26,28		
					SF/UTP	1x4xAWG26/19	4.8	EtherCAT®	QP	UL/CSA Typ CMX	ETHERLINE® P EC FD Cat.5e	2170432	170	4,5,6,7,8,9,10,11,15	12,17,20,22,25,26,28		
		Cat.5	high flexible	x	PUR	SF/UTP	2x2xAWG22/7	6.8	PROFINET®, EtherCAT®	QP, power chain, Fast Connect	UL/CSA Typ CMX, UL (AWM) 1000 V Rating	ETHERLINE® FD P FC Cat.5	2170894	160	4,5,7,8,10,11,15	12,21,23,25,26,28	
						SF/UTP	2x2xAWG22/19	6.8	PROFINET®, EtherCAT®	QP, torsion	UL/CSA (AWM)	ETHERLINE® TORSION Cat.5	2170888	162	4,5,7,8,10,13,14,15	12,17,21,23,25,26,28	
		indoor and outdoor	Cat.5	static	PVC	x	PUR	SF/UTP	2x2xAWG22/1	6.8	PROFINET®, EtherCAT®	QP, Fast Connect	UL/CSA Typ PLTC and CMG	ETHERLINE® Y FC Cat.5	2170893	158	4,5,7,8,10,13,14,15
	SF/UTP							2x2xAWG22/1	6.1			UL (AWM) 1000 V Rating	ETHERLINE® P Cat.5e	2170281	153	4,5,7,8,10,13,14,15	12,20,22,25,26,28
	Cat.5e		static	x	PUR	SF/UTP	2x2xAWG24/1	6.1				UL (AWM) 1000 V Rating	ETHERLINE® P Cat.5e	2170281	153	4,5,7,8,10,13,14,15	12,20,22,25,26,28
						SF/UTP	2x2xAWG22/7	6.8	PROFINET®, EtherCAT®	QP, Fast Connect	UL/CSA Typ CMG	ETHERLINE® PN Cat.5 Y FLEX FC	2170886	159	4,5,7,8,10,13,14,15	12,21,23,25,26,28	
	Cat.5e		flexible	x	FRNC	SF/UTP	2x2xAWG22/7	6.8	PROFINET®, EtherCAT®	QP, Fast Connect	UL/CSA Typ CMG	ETHERLINE® PN Cat.5e FRNC FLEX FC	2170890	159	4,5,7,8,10,11,13,14	12,17,20,22,25,26,28	
						SF/UTP	2x2xAWG22/7	6.5	PROFINET®, EtherCAT®	QP, black UV res		ETHERLINE® Y Cat.5e BK	2170901	161	4,5,7,8,10,13,14,15	12,21,23,25,26,28	
	Cat.5		flexible	x	FRNC	SF/UTP	2x2xAWG22/7	6.5	PROFINET®, EtherCAT®	Application Marine, Fast Connect	UL/CSA Typ PLTC and CMG Germanischer Lloyd, Lloyds Register of Shipping, ABS Europe Ltd Bureau Veritas, Det Norske Veritas (DNV)		ETHERLINE® MARINE FRNC FC	2170889	171	4,5,7,8,10,11,13,14,15	12,17,20,22,25,26,28
SF/UTP						2x2xAWG22/7	6.5	PROFINET®, EtherCAT®	for hollow shaft between gear units and pitch system		ETHERLINE® Cat.5e 105 plus	2170636	163	4,5,7,8,10,11,13,14,15	12,17,20,22,25,26,28		
Cat.5e	flexible	x	PUR	S/UTP	2x2xAWG26/7	5.9				UL (AWM) 1000 V Rating	ETHERLINE® P Flex Cat.5e	2170284	154	1,4,5,7,8,10,13,14,15	12,21,23,25,26,28		
outdoor and ground	Cat.5	static			PVC/PE	SF/UTP	2x2xAWG22/1	9.8	PROFINET®, EtherCAT®	QP, steel armoured, black, UV resistant		ETHERLINE® Cat.5 ARM	2170496	157	4,5,7,8,10,13,14,15	20,22,25,26,28	
						SF/UTP	2x2xAWG22/1	7.7	PROFINET®, EtherCAT®	QP, double sheath, black, UV resistant	UL/CSA Typ CMG	ETHERLINE® PN Cat.5e YY	2170494	158	4,5,7,8,10,13,14,15	12,20,22,25,26,28	
Industrial 2-pairs combi	indoor	Cat.5	flexible	x	FRNC	SF/UTP	2x2xAWG22/7 + 4x1.5	10.6	PROFINET®	Hybrid	UL (AWM)	ETHERLINE® Cat.5 FRNC HYBRID	2170887	157			

See continuation page 145

## Quickfinder (continuation)

Automation area	Inst. area	Category	Application/cabling	halogen-free	Sheath material	Shielding (standard description)	AWG	Outer diameter [mm]	Industrial Ethernet Systems	Characteristics	Approvals	Article designation	Article number	Page	Connectors	Socket (SnapIn)		
Industrial 4-pairs	indoor	Cat.5e	static	x	H	SF/UTP	4x2xAWG24/1	6.3				ETHERLINE® H Cat.5e	2170296	153	4,5,7,8,10,16	12,20,22,25,26,28		
					FRNC	F/UTP	4x2xAWG23/1	6.3/8.3		isolation integrity	PH60 acc. to EN50200	ETHERLINE® FIRE Cat.5e PH60	2170904	171	5,7,5,10,16	12,18,19,25,26,28		
					H/H	SF/UTP	4x2xAWG24/1	6.3		double sheath		ETHERLINE® H-H Cat.5e	2170298	153	4,5,7,8,10,16	12,20,22,25,26,28		
		flexible	x	H	SF/UTP	4x2xAWG26/7	6.1				ETHERLINE® H Flex Cat.5e	2170299	154	4,5,7,8,10,16	12,21,23,25,26,28			
				PVC	SF/UTP	4x2xAWG26/7	6.4			UL/CSA Typ CMG	ETHERLINE® Y FLEX Cat.5e	2170486	154	4,5,7,8,10,16	12,18,19,25,26,28			
				PUR	SF/UTP	4x2xAWG24/1	6.3		limited UV resistance	UL (AWM) 1000 V Rating	ETHERLINE® P Cat.5e	2170297	153	4,5,6,7,8,9,10,11,16	12,20,22,25,26,28			
	indoor and outdoor	Cat.5e	flexible	x	PUR	SF/UTP	4x2xAWG26/7	6.3		limited UV resistance	UL (AWM) 1000 V Rating	ETHERLINE® P Flex Cat.5e	2170300	154	4,6,9,16	12,21,23,25,26,28		
					PUR	S/UTP	4x2xAWG26/19	6.6		easy to wind, best for stage, power chain, black, UV resistant	UL (AWM) 1000 V Rating	ETHERLINE® FD BK Cat.5	CE217489	156	4,5,6,7,8,9,10,11,16	12,21,23,25,26,28		
		Cat.6	high flexible	x	PUR	S/UTP	4x2xAWG26/19	6.1		power chain, limited UV resistance	UL (AWM) 1000 V Rating	ETHERLINE® FD P Cat.5e	2170489	155	4,5,6,7,8,9,10,11,16	12,23,25,26,28		
	indoor	Cat.6 <sub>A</sub>	static	x	PVC	S/FTP	4x2xAWGG22/1	9.0	PROFINET®				ETHERLINE® Cat.6 <sub>A</sub> Y	2170464	164	4,5,7,8,10,11,16	12,22,25,26,28	
					PUR	S/FTP							ETHERLINE® Cat.6 <sub>A</sub> P	2170465	164	4,5,7,8,10,11,16	12,22,25,26,28	
					H	S/FTP							ETHERLINE® Cat.6 <sub>A</sub> H	2170466	164	4,5,7,8,10,11,16	12,22,25,26,28	
			flexible	x	PVC	S/FTP	4x2xAWG23/7	9.0	PROFINET®				UL/CSA Typ CMG	ETHERLINE® PN Cat.6 <sub>A</sub> Y FLEX	2170930	165	5,7,8,10,11,16	12,18,19,25,26,28
					FRNC	S/FTP							UL/CSA Typ CMG	ETHERLINE® PN Cat.6 <sub>A</sub> FRNC FLEX	2170931	165	5,7,8,10,11,16	12,18,19,25,26,28
					PVC	S/FTP							4x2xAWG24/7	9.0	PROFINET®	power chain	UL/CSA Typ CMX	ETHERLINE® FD Cat.6 <sub>A</sub>
		PUR	S/FTP	UL/CSA Typ CMX, UL (AWM) 1000 V Rating	ETHERLINE® FD P Cat.6 <sub>A</sub>	2170484	166	5,7,8,10,11,16	12,18,19,25,26,28									
		PVC	S/FTP	4x2xAWG24/7	9.0	PROFINET®	torsion	UL/CSA Typ CMX	ETHERLINE® TORSION Y Cat.6 <sub>A</sub>	2170482	167	5,7,8,10,11,16					12,18,19,25,26,28	
		PUR	S/FTP					UL/CSA Typ CMX, UL (AWM) 1000 V Rating	ETHERLINE® TORSION P Cat.6 <sub>A</sub>	2170483	167	5,7,8,10,11,16	12,18,19,25,26,28					
		Cat.7	static	x	PVC	S/FTP	4x2xAWGG22/1	9.0	PROFINET®					ETHERLINE® Cat.7 Y	2170474	164	4,5,7,8,10,11,16	12,22,25,26,28
					PUR	S/FTP								ETHERLINE® Cat.7 P	2170475	164	4,5,7,8,10,11,16	12,22,25,26,28
					H	S/FTP								ETHERLINE® Cat.7 H	2170476	164	4,5,7,8,10,11,16	12,22,25,26,28
	outdoor and ground	Cat.7	static			(L)PE	S/FTP	4x2xAWG23/1	10		PE-AL-outer sheath, direct burial		UNITRONIC® LAN 1000 S/FTP Cat.7 (L)PE	2170198	*			
						PE	S/FTP	4x2xAWG23/1	9.6		PE-outer sheath		UNITRONIC® LAN 1000 S/FTP Cat.7 PE	2170197	*			

ISO/IEC-11801 (2002)	Lapp product-designations	Construction (outdoor/indoor)
U/UTP	UTP	Unshielded/Unshielded Twisted Pair
F/UTP	F/UTP	Foiled/Unshielded Twisted Pair
S/UTP	S-UTP	Screened/Unshielded Twisted Pair
SF/UTP	S-FTP	Screened+Foiled/Unshielded Twisted Pair
S/FTP	STP/S PiMF	Screened/Foiled Twisted Pair

### Legend

PN = PROFINET®, cables acc. to PROFINET® standard  
 QP = Quad Pair, star quad cable

Please see detailed technical information on the data sheet ([www.lappgroup.com/products](http://www.lappgroup.com/products)).



# ETHERNET in Automation

## Industrial Ethernet patchcords

Industrial Ethernet protocol		2-pair cable														4-pair cable						
		PROFINET®						Industrial Ethernet				EtherCAT®		EtherCAT®		Industrial Ethernet						
		Type A		Type B		Type C		halogenfree		PUR		PVC FLEX		PUR FD		halogenfree		PUR				
		length in m	Article number	Page	Article number	Page	Article number	Page	Article number	Page	Article number	Page	Article number	Page	Article number	Page	Article number	Page	Article number	Page		
Connector to connector	M12-M12 (straight)	1	2171001	173	2171025	175	2171049	177	2171073	182	2171097	179			2171779	187						
		2	2171002	173	2171026	175	2171050	177	2171074	182	2171098	179			2171780	187						
		3	2171003	173	2171027	175	2171051	177	2171075	182	2171099	179			2171781	187						
		5	2171004	173	2171028	175	2171052	177	2171076	182	2171100	179			2171782	187						
		10	2171005	173	2171029	175	2171053	177	2171077	182	2171101	179			2171783	187						
		20	2171006	173	2171030	175	2171054	177	2171078	182	2171102	179			2171784	187						
		1	2171013	173	2171037	175	2171061	177							2171786	187						
		2	2171014	173	2171038	175	2171062	177							2171787	187						
		3	2171015	173	2171039	175	2171063	177							2171788	187						
		5	2171016	173	2171040	175	2171064	177							2171789	187						
10	2171017	173	2171041	175	2171065	177							2171790	187								
20	2171018	173	2171042	175	2171066	177							2171791	187								
Connector to connector	M12-RJ45 (straight)	1						2171085	184	2171109	181			2171751	189							
		2						2171086	184	2171110	181			2171752	189							
		3						2171087	184	2171111	181			2171753	189							
		5						2171088	184	2171112	181			2171754	189							
		10						2171089	184	2171113	181			2171755	189							
		20						2171090	184	2171114	181			2171756	189							
		1						2171091	185	2171115	181			2171765	189	2171513	185	2171501	184			
		2						2171092	185	2171116	181			2171766	189	2171514	185	2171502	184			
		3						2171093	185	2171117	181			2171767	189	2171515	185	2171503	184			
		5						2171094	185	2171118	181			2171768	189	2171516	185	2171504	184			
10						2171095	185	2171119	181			2171769	189	2171517	185	2171505	184					
20						2171096	185	2171120	181			2171770	189	2171518	185	2171506	184					
Connector to connector	M8-M8 (straight)	0,5											2171300	191	2171700	193						
		1											2171301	191	2171701	193						
		2											2171302	191	2171702	193						
		3											2171303	191	2171703	193						
		5											2171304	191	2171704	193						
		7											2171305	191	2171705	193						
		10											2171306	191	2171706	193						
		15											2171307	191	2171707	193						
		20											2171308	191	2171708	193						
		0,5											2171350	191	2171718	193						
Connector to connector	M8 (angled) - M8 (straight)	1											2171351	191	2171719	193						
		2											2171352	191	2171720	193						
		3											2171353	191	2171721	193						
		5											2171354	191	2171722	193						
		7											2171355	191	2171723	193						
		10											2171356	191	2171724	193						
		15											2171357	191	2171725	193						
		20											2171358	191	2171726	193						
		Connector on free conductor end (OE)	M12 (straight) - OE	1	2171007	174	2171031	176	2171055	178	2171079	183	2171103	180			2171793	188				
				2	2171008	174	2171032	176	2171056	178	2171080	183	2171104	180			2171794	188				
3	2171009			174	2171033	176	2171057	178	2171081	183	2171105	180			2171795	188						
5	2171010			174	2171034	176	2171058	178	2171082	183	2171106	180			2171796	188						
10	2171011			174	2171035	176	2171059	178	2171083	183	2171107	180			2171797	188						
20	2171012			174	2171036	176	2171060	178	2171084	183	2171108	180			2171798	188						
1	2171019			174	2171043	176	2171067	178							2171871	188						
2	2171020			174	2171044	176	2171068	178							2171872	188						
3	2171021			174	2171045	176	2171069	178							2171873	188						
5	2171022			174	2171046	176	2171070	178							2171874	188						
10	2171023	174	2171047	176	2171071	178							2171875	188								
20	2171024	174	2171048	176	2171072	178							2171876	188								
Connector on free conductor end (OE)	RJ45 (straight) - OE	1													2171772	190	2171519	186	2171507	185		
		2													2171773	190	2171520	186	2171508	185		
		3													2171774	190	2171521	186	2171509	185		
		5													2171775	190	2171522	186	2171510	185		
		10													2171776	190	2171523	186	2171511	185		
		20													2171777	190	2171524	186	2171512	185		
		0,5												2171320	192	2171709	194					
		1												2171321	192	2171710	194					
		2												2171322	192	2171711	194					
		3												2171323	192	2171712	194					
Connector on free conductor end (OE)	M8 (straight) - OE	5											2171324	192	2171713	194						
		7											2171325	192	2171714	194						
		10											2171326	192	2171715	194						
		15											2171327	192	2171716	194						
		20											2171328	192	2171717	194						
		0,5											2171370	192	2171727	194						
		1											2171371	192	2171728	194						
		2											2171372	192	2171729	194						
		3											2171373	192	2171730	194						
		5											2171374	192	2171731	194						
Connector on free conductor end (OE)	M8 (angled) - OE	7										2171375	192	2171732	194							
		10										2171376	192	2171733	194							
		15										2171377	192	2171734	194							
		20										2171378	192	2171735	194							
		used cable	Article number	Page	Article number	Page	Article number	Page	Article number	Page	Article number	Page	Article number	Page	Article number	Page	Article number	Page	Article number	Page		
			2170893	158	2170886	159	2170894	160	2170283	154	2170284	154	2170430	169	2170432	170	2170299	154	2170300	154		



In the field of Industrial Automation more than 20 different Industrial Ethernet protocols are defined by companies. All of them differ from their application field and technical functions to each other.

## PROFINET® (PNO – ProfibusNutzerOrganisation)

The installation guide defines three different types of cables for their optimal use in different applications and environments:

- Type A stationary, no movement after installation, solid wire
- Type B flexible, occasional movement of vibration, 7-stranded wire
- Type C special applications (high flexible, draig chain, ...)

This guideline defines also the design of the cable types.

Using a two pair cable with a min. category Cat.5, the design has to be:

- Type A 2x2xAWG22/1
- Type B 2x2xAWG22/7
- Type C 2x2xAWG22/...

Mostly the cables have a design of a quad star.

Using a four pair cable with a min category Cat.5, the design has to be:

- Type A 4x2xAWG23/1 (min. AWG23)
- Type B 4x2xAWG23/7 (min. AWG23)
- Type C 4x2xAWG24/... (min. AWG24)

EtherNet/IP® or EtherCAT® are using Cat.5 standard cable, which are specified for industrial applications.

Sercos III uses also standard components like Cat.5 cable with a double shielding.

## With ETHERLINE® products are you fit for future

If you want to avoid failures, down times and quality problems, you can trust on our complete and high quality product system. Lapp takes care to offer products of individuality and costumer requirement as well as long time usability. Our big product range of ETHERLINE® cables are suitable for nearly any application and is tested in our test laboratory, for example in drag chains. If there are special requirements as flexibility for applications in drag chains, with torsion stress, industrial environments with high mechanical or temperature specifications, you can find some real all-rounders in the Lapp product program. If you are at the point where you will connect your cable to a device, you can also find suitable connectors, for example RJ45 or M12 connectors. Nearly for every cable and application you can choose the right connector, mostly with you need no special assembly tool. For some applications and for saving time and money, Lapp offers also a big range of patch cords. There the Industrial Ethernet ETHERLINE® cables are used and are assembled with connectors who are especially produced for industrial requirements. The patch cords are completely tested in our plant and you can trust on Industrial Protection classes and transmission rates.

Application classes (LAN copper cabling)			
Application class	Category	Frequency	Services and applications
Class A	-	Up to 100 kHz	
Class B	-	Up to 1 MHz	Telephone, ISDN
Class C	Cat.3	Up to 16 MHz	Tel, ISDN, TokenRing, Ethernet
Class D	Cat.5/5e	Up to 100 MHz	Fast Ethernet, Gigabit Ethernet
Class E	Cat.6	Up to 250 MHz	Fast Ethernet, Gigabit Ethernet
Class E <sub>A</sub>	Cat.6 <sub>A</sub>	Up to 500 MHz	10 Gigabit Ethernet
Class F	Cat.7	Up to 600 MHz	10 Gigabit Ethernet
Class F <sub>A</sub>	Cat.7 <sub>A</sub>	Up to 1 GHz	10 Gigabit Ethernet

Connectors

Connectors							
No.	Cable type	Max. Ø-cable	Category	Core dimension	Article designation	Article number	Page
<b>RJ45 connector</b>							
1	flexible	5.8 mm	Cat.5	AWG26	RJ45 connector TM11 Hirose, beige	CE6321	195
2	flexible	5.72 mm	Cat.5	AWG26	RJ45 connector Stewart, grey	CE6323	195
3	solid + flexible	6.6 mm	Cat.6	AWG27 - 24	RJ45 connector TM21 Hirose, beige	CE6324	195
4	solid + flexible	8 mm	Cat.5e	AWG26 - 22	RJ45 connector FM45	21700540	195
5	solid + flexible	9 mm	Cat.6 <sub>A</sub>	solid: AWG24 - 22 flexible: AWG27 - 22	RJ45 connector Cat.6 <sub>A</sub> field attachable TIA568A EPIC® Data ED-IE-AX-6A-A-20-FC	21700600	197
6	solid + flexible	9 mm	Cat.6 <sub>A</sub>	massiv: AWG26 - 24 flexibel: AWG27 - 24	RJ45 connector Cat.6 <sub>A</sub> field attachable TIA568A EPIC® Data ED-IE-AX-6A-A-20-FD-FC	21700615	197
7	solid + flexible	10 mm	Cat.6 <sub>A</sub>	solid: AWG24 - 22 flexibel: AWG27 - 22	RJ45 connector, angled, Cat.6 <sub>A</sub> field attachable TIA568A EPIC® Data ED-IE-90-6A-A-20-FC	21700636	197
8	solid + flexible	9 mm	Cat.6 <sub>A</sub>	solid: AWG24 - 22 flexible: AWG27 - 22	RJ45 connector Cat.6 <sub>A</sub> field attachable TIA568B EPIC® Data ED-IE-AX-6A-B-20-FC	21700601	197
9	solid + flexible	9 mm	Cat.6 <sub>A</sub>	massiv: AWG26 - 24 flexibel: AWG27 - 24	RJ45 connector Cat.6 <sub>A</sub> field attachable TIA568B EPIC® Data ED-IE-AX-6A-B-20-FD-FC	21700616	197
10	solid + flexible	10 mm	Cat.6 <sub>A</sub>	solid: AWG24 - 22 flexible: AWG27 - 22	RJ45 connector, angled, Cat.6 <sub>A</sub> field attachable TIA568B EPIC® Data ED-IE-90-6A-B-20-FC	21700637	197
11	solid + flexible	9 mm	Cat.6 <sub>A</sub>	solid: AWG24 - 22 flexible: AWG27 - 22	circular connector IP68 (incl. 21700601) ED-IE-AX-RJ45-6A-B-68-FC	21700630	198
12	solid + flexible	9 mm	Cat.6 <sub>A</sub>	solid: AWG24 - 22 flexible: AWG27 - 22	circular bulkhead housing IP68 (incl. 21700612) ED-IE-RJ45F-6A-B-68-FC	21700632	198
13	solid + flexible	9 mm	Cat.5	solid: AWG24 - 22 flexible: AWG27 - 22	RJ45 connector Cat.5 field attachable connector PROFINET® ED-IE-AX-5-PN-20-FC	21700605	196
14	solid + flexible	10 mm	Cat.5	solid: AWG24 - 22 flexible: AWG27 - 22	RJ45 connector, angled, Cat.5 field attachable PROFINET® ED-IE-90-5-PN-20-FC	21700638	196



<b>M12 male connector</b>							
15	flexible	8 mm	Cat.5e	flexible: AWG26 - 22	AB-C4-M12MSD-SH (PROFINET®)	22260820	133
16	solid + flexible	9 mm	Cat.6 <sub>A</sub>	solid: AWG24 - 22 flexible: AWG27 - 22	ED-IE-AX-M12X-6A-67-FC 10G/X-coded	21700602	198



<b>M12 female connector</b>							
17	flexible	8 mm	Cat.5e	flexible: AWG26 - 22	AB-C4-M12FSD-SH (PROFINET®)	22261016	133
18	solid + flexible	9 mm	Cat.6 <sub>A</sub>	solid: AWG24 - 22 flexible: AWG27 - 22	ED-IE-AX-M12XF-6A-67-FC 10G/X-coded	21700621	198
19	solid + flexible	9 mm	Cat.6 <sub>A</sub>	solid: AWG24 - 22 flexible: AWG27 - 22	ED-IE-AX-M12XF-RM-6A-67-FC 10G/X-coded	21700622	198



<b>LANmark SnapIn RJ45 socket</b>							
20	solid	-	Cat.5e	AWG24/1 - 22/1	LANmark-5 EVO Snap-In connector	61103	*
21	flexible	-	Cat.5e	AWG26/7	LANmark-5 EVO Snap-In connector AWG26	61102	*
22	solid	-	Cat.6	AWG24/1 - 22/1	LANmark-6 EVO 250 MHz Snap-In connector	62104	*
23	flexible	-	Cat.6	AWG26/7	LANmark-6 EVO 250MHz Snap-In for AWG26	62105	*
24	solid	-	Cat.6 <sub>A</sub>	AWG24/1 - 22/1	LANmark-6 EVO 10 G Snap-In connector	62106	*
25	solid + flexible	5 - 9 mm	Cat.6 <sub>A</sub>	AWG27 - 22	ED-IE-AX-RJ45F-6A-A-FC	21700611	199
26	solid + flexible	5 - 9 mm	Cat.6 <sub>A</sub>	AWG27 - 22	ED-IE-AX-RJ45F-6A-B-FC	21700612	199
27	solid + flexible	-	Cat.6	AWG24 - 22	SnapIn Rail mount adapter 1-single incl. Cat.6	60795	*
28	solid + flexible	5 - 9 mm	Cat.6 <sub>A</sub>	AWG27 - 22	easy connect rail mount adapter 1-single incl. Cat.6 <sub>A</sub>	21700613 21700614	200



<b>LANmark SnapIn GG45 socket</b>							
29	solid	-	Cat.7	AWG24/1 - 22/1	LANmark-7, 600 MHz Snap-In GG45 connector	63103	*



Connector pin assignments						
TIA 568-A	TIA 568-B	PROFINET®	RJ45	M12 D-coded	M12 X-coded	M8
White/Green	White/Orange	Yellow	1	1	1	1
Green	Orange	Orange	2	3	2	4
White/Orange	White/Green	White	3	2	3	2
Blue	Blue	-	4		8	
White/Blue	White/Blue	-	5		7	
Orange	Green	Blue	6	4	4	3
White/Brown	White/Brown	-	7		5	
Brown	Brown	-	8		6	

**Legend**

\*see [www.lappgroup.com/products](http://www.lappgroup.com/products). Please see detailed technical information on the data sheet ([www.lappgroup.com/products](http://www.lappgroup.com/products)).

## Industrial ethernet articlecode for patchcords

### IE - PN - 5 - M8 - S - 1 - H - 2 - 22 - FD - M8 - S

1 2 3 4 5 6 7 8 9 10 11 12

- 1 Type**  
IE = Industrial Ethernet
- 2 Bussystem**  
PN = PROFINET®  
PNA = PROFINET® Type A  
PNB = PROFINET® Type B  
PNC = PROFINET® Type C  
EC = EtherCAT®  
S3 = Sercos 3
- 3 Category**  
5 = Cat.5  
5e = Cat.5e  
6 = Cat.6  
6A = Cat.6<sub>A</sub>  
7 = Cat.7  
7A = Cat.7<sub>A</sub>  
10G = 10 Gbit/s
- 4 Connection left**  
M8 = M8  
M12D = M12 D-coded male  
M12DF = M12 D-coded female  
M12X = M12 X-coded male  
M12XF = M12 X-coded female  
RJ45 = RJ45
- 5 Cable outlet**  
S = Straight (180°)  
A = Angled (90°)
- 6 Cable length**  
1 = 1 m  
2 = 2 m  
3 = 3 m  
5 = 5 m  
10 = 10 m  
15 = 15 m  
20 = 20 m
- 7 Outer sheath material**  
H = Halogen free  
P = PUR  
Y = PVC  
FRNC = Flame retardant & halogen free  
PE = PE
- 8 Pairs**  
2 = 2x2  
4 = 4x2
- 9 AWG (cross section)**  
22 = AWG22  
23 = AWG23  
24 = AWG24  
26 = AWG26  
27 = AWG27
- 10 Installation type**  
1 = Fixed installation  
7 = Flexible installation  
FD = Drag chain application  
T = Torsion stressed application
- 11 Connection right**  
M8 = M8  
M12D = M12 D-coded male  
M12DF = M12 D-coded female  
M12X = M12 X-coded male  
M12XF = M12 X-coded female  
RJ45 = RJ45  
OE = Open conductor end
- 12 Cable outlet**  
S = Straight (180°)  
A = Angled (90°)

## EPIC® DATA Code for Ethernet applications

### ED - IE - 90 - M12 - X - RM - 6A - A - 54 - FD - FC - AC

1 2 3 4 5 6 7 8 9 10 11 12

- 1 Type**  
ED = EPIC® DATA
- 2 Bussystem**  
IE = Industrial Ethernet
- 3 Cable outlet**  
90 = 90°  
45 = 45°  
35 = 35°  
AX = Straight (0°)
- 4 Type of connection**  
N/A/RJ45 = RJ45 male  
RJ45F = RJ45 female  
M12 = M12 male  
M12F = M12 female  
M8 = M8 male  
HY = Hybrid  
H = H3A
- 5 Coding**  
N/A = D-coded  
X = X-coded  
A = A-coded
- 6 Mounting version**  
RM = Rear-mounting  
FM = Front-mounting
- 7 Category**  
5 = Cat.5  
5e = Cat.5e  
6 = Cat.6  
6A = Cat.6<sub>A</sub>  
7 = Cat.7  
7A = Cat.7<sub>A</sub>
- 8 Standard for pin assignment**  
A = T568A  
B = T568B  
PN = PROFINET®
- 9 Protection class**  
N/A = IP20 (= Standard)  
54 = IP54  
65 = IP65  
67 = IP67  
68 = IP68
- 10 Special requirements**  
FD = Especially for 19 wire stranded cores
- 11 Cable connection**  
N/A = Screw (= Standard)  
FC = Fastconnect  
FZ = Spring type
- 12 Additional**  
AC = Accessory  
AC-DC = Accessory Dust Cap

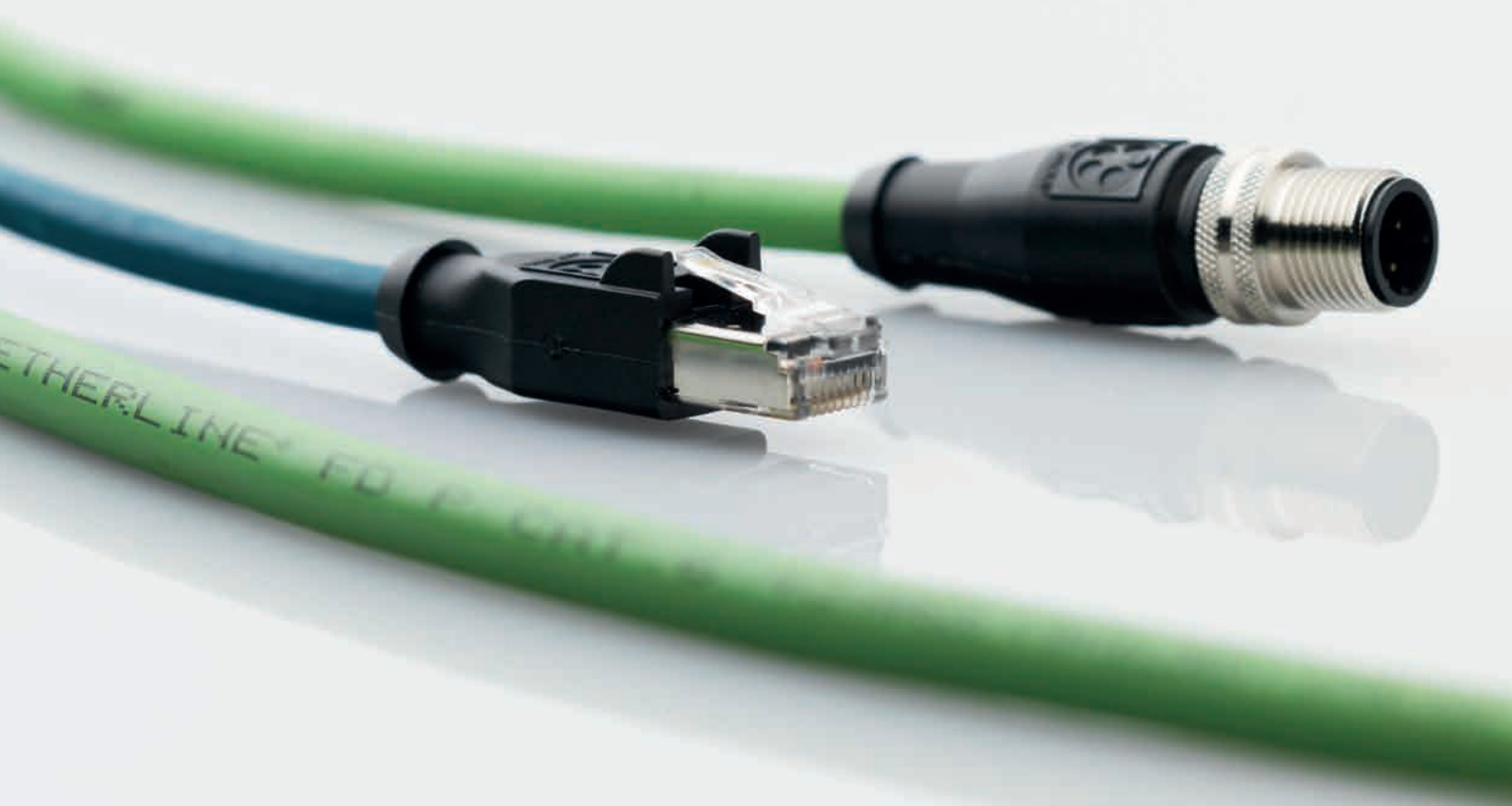



**ETHERLINE® Cat.5e**  
Fixed installation

**Info**

- Industrial Ethernet cable
- Cat.5e



**Benefits**

- Very low installation cost due to the use of Ethernet cables
- Screened against interference
- Seamless communication from the sensor/actuator level to the Internet
- Suitable for fixed installation in dry and damp rooms
- Cables with PUR jacket: 1000 V UL- rating for installation next to power cables

**Application range**

- 2pair: 10/100 Mbit/s for Industrial Ethernet
- 4pair: 10/100/1000 Mbit/s for Industrial Ethernet
- Suitable for EtherCAT and EtherNet/IP applications
- Industrial use
- Fixed installation

**Product features**

- High-quality, double screening ensures high transmission reliability in areas with electromagnetic interference
- PUR outer sheath is highly resistant to mineral oils and abrasion
- Halogen-free outer sheath
- Flame-retardant according IEC 60332-1-2
- CAT.5e-Performance

**Norm references / Approvals**

- PUR versions: UL AWM Style 21576

**Design**

- Solid conductor
- Core insulation made of foam skin
- SF/UTP: copper braid and foil screening as overall screening
- Outer sheath as either PUR or LSZH
- Colour: water blue (RAL 5021)
- 2 or 4-pair version

**Technical data**

- Peak operating voltage**  
(not for power applications) 125 V
- Minimum bending radius**  
Fixed installation: 7.5 x outer diameter (2 pair cable)  
Fixed installation: 8 x outer diameter (4 pair cable)
- Test voltage**  
Core/core: 1000 V  
Core/screen: 500 V
- Characteristic impedance**  
100 Ohm +/- 15%
- Temperature range**  
PUR cable  
Fixed installation: VDE -30°C to +80°C;  
UL/CSA -30°C to +80°C  
moved: VDE -5°C to +50°C;  
UL/CSA -5°C to +80°C  
cable halogenfree compound  
Fixed installation: -30°C to +80°C  
moved: -5°C to +60°C

Article number	Article designation	Number of pairs and AWG per conductor	Max. outer diameter (mm)	Copper index (kg/km)	Weight (kg/km)
<b>2-pair version</b>					
<b>Halogen-free compound</b>					
2170280	ETHERLINE® H CAT.5e	2 x 2 x AWG24/1	6.1	22.0	45
<b>PUR outer sheath, halogen-free</b>					
2170281	ETHERLINE® P CAT.5e	2 x 2 x AWG24/1	6.1	22.0	53
<b>4-pair version</b>					
<b>Halogen-free compound</b>					
2170296	ETHERLINE® H CAT.5e	4 x 2 x AWG24/1	6.3	32.0	54
2170298	ETHERLINE® H-H CAT.5e	4 x 2 x AWG24/1	6.3 / 8.3	32.0	80
<b>Outer sheath: PUR, halogen-free</b>					
2170297	ETHERLINE® P CAT.5e	4 x 2 x AWG24/1	6.3	32.0	62

Unless specified otherwise, the shown product values are nominal values. Detailed values (e.g. tolerances) are available upon request.  
Please find our standard lengths at: [www.lappkabel.de/en/cable-standardlengths](http://www.lappkabel.de/en/cable-standardlengths)  
Packaging size: coil ≤ 30 kg or ≤ 250 m, otherwise drum  
Detailed data sheets are available upon request. Please specify the type/dimensions of the required cable.  
Photographs are not to scale and do not represent detailed images of the respective products.

**Accessories**

- Field-Terminable Connector RJ45 CAT.5e FM45 refer to page 195
- BUS M12 connectors that can be assembled
- Easy connect rail mount adapter Cat.6<sub>A</sub> refer to page 200
- Connector M12 x-coded Cat.6<sub>A</sub> 10G fieldmountable refer to page 198
- EPIC® DATA CCR FA refer to page 199
- SMART STRIP stripping tool
- DATA STRIP stripping tool





## ETHERLINE® Cat.5e FLEX

### Flexible use

LAPP KABEL STUTTGART ETHERLINE® Y Flex CAT.5e 4x2xAWG26/7

LAPP KABEL STUTTGART ETHERLINE® P Flex CAT.5e

**Info**

- Industrial Ethernet cable
- Cat.5e

#### Benefits

- Seamless communication from the sensor/actuator level to the Internet
- Cables with PUR jacket: 1000 V UL- rating for installation next to power cables
- Screened against interference
- Can be used in dry or damp rooms
- Industrial use

#### Application range

- 2pair: 10/100 Mbit/s for Industrial Ethernet
- 4pair: 10/100/1000 Mbit/s for Industrial Ethernet
- Suitable for EtherCAT and EtherNet/IP applications
- For flexible applications (7-wire stranded conductor)
- Only for patch cable applications (max. 60 m)

#### Product features

- High-quality, double screening ensures high transmission reliability in areas with electromagnetic interference
- Halogen-free outer sheath
- PUR outer sheath is highly resistant to mineral oils and abrasion
- Flame-retardant according IEC 60332-1-2
- CAT.5e-Performance

#### Norm references / Approvals

- PVC version has UL/CSA (CMG) approval.
- PUR versions: UL AWM Style 21576

#### Design

- Stranded conductor, 7-wire, bare
- Core insulation made of foam skin
- SF/UTP: copper braid and foil screening as overall screening
- Outer sheath as either PUR or LSZH
- Colour: water blue (RAL 5021)
- 2 or 4-pair version

#### Technical data

- Peak operating voltage**  
(not for power applications) 125 V
- Minimum bending radius**  
Fixed installation: 8 x outer diameter  
Flexing: 15 x outer diameter
- Test voltage**  
Core/core: 1000 V  
Core/screen: 500 V
- Characteristic impedance**  
100 Ohm +/- 15%
- Temperature range**  
PUR cable  
Fixed installation: VDE -30°C to +80°C;  
UL/CSA -30°C to +80°C  
moved: VDE -5°C to +50°C;  
UL/CSA -5°C to +80°C  
cable halogenfree compound  
Fixed installation: -30°C to +80°C  
moved: -5°C to +60°C  
cable with PVC jacket  
Fixed installation: -40°C to +80°C  
moved: -10°C to +70°C

Article number	Article designation	Number of pairs and AWG per conductor	Max. outer diameter (mm)	Copper index (kg/km)	Weight (kg/km)
<b>2-pair version</b>					
<b>Halogen-free compound</b>					
2170283	ETHERLINE® H Flex CAT.5e	2 x 2 x AWG26/7	5.9	19.0	43
<b>PUR outer sheath, halogen-free</b>					
2170284	ETHERLINE® P Flex CAT.5e	2 x 2 x AWG26/7	5.9	19.0	45
<b>4-pair version</b>					
<b>Halogen-free compound</b>					
2170299	ETHERLINE® H Flex CAT.5e	4 x 2 x AWG26/7	6.3	25.0	48
<b>PUR outer sheath, halogen-free</b>					
2170300	ETHERLINE® P Flex CAT.5e	4 x 2 x AWG26/7	6.3	25.0	54
<b>PVC version</b>					
2170486	ETHERLINE® Y Flex CAT.5e	4 x 2 x AWG26/7	6.4	30.0	54

Unless specified otherwise, the shown product values are nominal values. Detailed values (e.g. tolerances) are available upon request.  
Please find our standard lengths at: [www.lappkabel.de/en/cable-standardlengths](http://www.lappkabel.de/en/cable-standardlengths)  
Packaging size: coil ≤ 30 kg or ≤ 250 m, otherwise drum  
Detailed data sheets are available upon request. Please specify the type/dimensions of the required cable.  
Photographs are not to scale and do not represent detailed images of the respective products.

#### Accessories

- Field-Terminable Connector RJ45 CAT.5e FM45 refer to page 195
- Connector RJ45 Cat.6<sub>A</sub> FM for FD-cables
- Easy connect rail mount adapter Cat.6<sub>A</sub> refer to page 200
- Connector M12 x-coded Cat.6<sub>A</sub> 10G fieldmountable refer to page 198
- EPIC® DATA CCR FA refer to page 199
- DATA STRIP stripping tool



## ETHERLINE® Cat.5e FD

Highly flexible application

**Info**

- Industrial Ethernet cable
- For highly flexible applications



### Benefits

- Very low installation cost due to the use of Ethernet cables
- Screened against interference
- Seamless communication from the sensor/actuator level to the Internet
- Industrial use
- Can be used in dry or damp rooms

### Application range

- 2pair: 10/100 Mbit/s for Industrial Ethernet
- 4pair: 10/100/1000 Mbit/s for Industrial Ethernet
- Only for patch cable applications (max. 60 m)
- Suitable for EtherCAT and EtherNet/IP applications
- Power chain applications

### Product features

- High-quality, double screening ensures high transmission reliability in areas with electromagnetic interference
- PUR outer sheath is highly resistant to mineral oils and abrasion
- Halogen-free outer sheath
- CAT.5e-Performance
- Cables with PUR jacket: 1000 V UL- rating for installation next to power cables

### Norm references / Approvals

- PUR versions: UL AWM Style 21576

### Design

- Braided conductor, 19-wire
- Inner sheath: thermoplastic elastomer, halogen-free
- Screening: wrapped with braided tinned-copper wires
- PUR outer sheath
- Colour: water blue (RAL 5021)
- 2 or 4-pair version

### Technical data

- Peak operating voltage** (not for power applications) 125 V
- Minimum bending radius**  
Fixed installation: 8 x outer diameter  
Flexing: 15 x outer diameter
- Test voltage**  
Core/core: 1000 V  
Core/screen: 500 V
- Characteristic impedance**  
100 Ohm +/- 15%
- Temperature range**  
PUR cable  
Fixed installation: VDE -30°C to +80°C;  
UL/CSA -30°C to +80°C  
moved: VDE -5°C to +50°C;  
UL/CSA -5°C to +80°C

Article number	Article designation	Number of pairs and AWG per conductor	Max. outer diameter (mm)	Copper index (kg/km)	Weight (kg/km)
<b>2-pair version</b>					
2170289	ETHERLINE® FD P CAT.5e	2 x 2 x AWG26/19	6.2	20.0	48
<b>4-pair version</b>					
2170489	ETHERLINE® FD P CAT.5e	4 x 2 x AWG26/19	6.6	27.0	54

Unless specified otherwise, the shown product values are nominal values. Detailed values (e.g. tolerances) are available upon request.

Please find our standard lengths at: [www.lappkabel.de/en/cable-standardlengths](http://www.lappkabel.de/en/cable-standardlengths)

Packaging size: Coil 100 m; Drum (500; 1000) m

Detailed data sheets are available upon request. Please specify the type/dimensions of the required cable.

Photographs are not to scale and do not represent detailed images of the respective products.

### Accessories

- Connector RJ45 CAT.6 Hirose TM21 refer to page 195
- Field-Terminable Connector RJ45 CAT.5e FM45 refer to page 195
- Connector RJ45 Cat.6<sub>A</sub> FM for FD-cables
- Connector industry RJ45 Cat.6<sub>A</sub> 10 IP68 refer to page 198
- SMART STRIP stripping tool
- DATA STRIP stripping tool



## ETHERLINE® Cat.5 FD BK

The Ethernet cable for installation in events



**Info**

- For highly flexible industrial applications
- CAT.5-Performance

### Benefits

- Additional application options thanks to suitability for outdoor use, UV-resistant
- Good flexibility - easy installation with tight space requirements
- Screened against interference
- Easy to coil for mobile use
- Usable on the roads

### Application range

- IEEE 802.3: 10/100/1000Base-T
- IEEE 802.5: ISDN; FDDI; ATM
- Suitable for the transfer of audio signals (ETHERSOUND), light control signals (DMX over Ethernet), or for computer networking
- Only for patch cable applications (max. 60 m)
- Suitable for EtherCAT and EtherNet/IP applications
- 4pair: 10/100/1000 Mbit/s for Industrial Ethernet

### Product features

- ETHERLINE® CAT.5 FD BK is a highly flexible, halogen-free, CATEGORY 5 high-speed data transmission cable, which specifically developed for road environments.
- Complies with standards EIA/TIA-568, TSB-36 and ISO/IEC IS 11801
- PUR outer sheath is highly resistant to mineral oils and abrasion
- Premium screening against electromagnetic interference
- CAT.5-Performance

### Norm references / Approvals

- UL AWM Style 21576

### Design

- Bare stranded copper wire, 26AWG (19 x 0.10), (0.14 mm<sup>2</sup>)
- Insulation: foam skin, max. core diameter 1.0 mm
- Twisting: 2 twisted-pair cores, stranding from 4 pairs
- Inner sheath: thermoplastic elastomer, halogen-free
- Screening: wrapped with braided tinned-copper wires
- Outer sheath: halogen-free PUR, black

### Technical data

- Minimum bending radius**  
Flexing: 15 x outer diameter  
Fixed installation: 8 x outer diameter
- Characteristic impedance**  
100 Ohm +/- 15%
- Temperature range**  
PUR cable  
Fixed installation: VDE -30°C to +80°C;  
UL/CSA -30°C to +80°C  
moved: VDE -5°C to +50°C;  
UL/CSA -5°C to +80°C

Article number	Article designation	Number of pairs and AWG per conductor	Max. outer diameter (mm)	Copper index (kg/km)	Weight (kg/km)
<b>ETHERLINE® Cat.5 FD BK</b>					
CE217489	ETHERLINE® FD P BK Cat.5	4x2xAWG26/19	6.6	27.0	54

Unless specified otherwise, the shown product values are nominal values. Detailed values (e.g. tolerances) are available upon request.  
 Copper price basis: EUR 150/100kg. Refer to catalogue appendix T17 for the definition and calculation of copper-related surcharges.  
 Standard lengths: (100; 500; 1000) m  
 Packaging size: coil ≤ 30 kg or ≤ 250 m, otherwise drum  
 Please specify the preferred type of packaging (e.g. 1 x 500 m drum or 5 x 100 m coils).  
 Photographs are not to scale and do not represent detailed images of the respective products.

### Similar products

- ETHERLINE® FD P CAT.5

### Accessories

- Connector RJ45 CAT.6 Hirose TM21 refer to page 195
- Field-Terminable Connector RJ45 CAT.5e FM45 refer to page 195
- Connector RJ45 Cat.6<sub>A</sub> FM for FD-cables
- SMART STRIP stripping tool



**Info**

- Industrial Ethernet cable
- CAT.5-Performance

## ETHERLINE® Cat.5 ARM

Fixed installation



### Benefits

- Very low installation cost due to the use of Ethernet cables
- EMC-optimised design
- With armouring for improved rodent protection
- Screened against interference

### Application range

- Can be used for Industrial Ethernet in harsh industrial environments
- 2pair: 10/100 Mbit/s for Industrial Ethernet
- Suitable for outdoor use, UV-resistant
- PROFINET application Type C but for fixed installation
- Suitable for direct burial

### Product features

- CAT.5-Performance
- Colour-coded in accordance with PROFINET for Cat.5 applications

### Design

- Solid and bare copper conductor
- Core insulation: PE
- Overlapping plastic tape
- SF/UTP: copper braid and foil screening as overall screening
- Inner sheath made of PVC (green RAL6018)
- 2 layer galvanzid steel tape
- Outer sheath made of black polyethylene (PE)

### Technical data

- Peak operating voltage**  
(not for power applications) 125 V
- Minimum bending radius**  
Fixed installation: 10 x outer diameter  
Flexing: 15 x outer diameter
- Test voltage**  
Core/core: 2000 V  
Core/screen: 2000 V
- Characteristic impedance**  
100 Ohm +- 15%
- Temperature range**  
Operation: -40 °C to +70 °C  
During installation: -20°C to +60°C

Article number	Article designation	Number of pairs and AWG per conductor	Max. outer diameter (mm)	Copper index (kg/km)	Weight (kg/km)
<b>Fixed installation</b>					
2170496	ETHERLINE® Cat.5 ARM	2 x 2 x AWG22/1	6.7 / 9.8	30.4	124

Unless specified otherwise, the shown product values are nominal values. Detailed values (e.g. tolerances) are available upon request. Please find our standard lengths at: [www.lappkabel.de/en/cable-standardlengths](http://www.lappkabel.de/en/cable-standardlengths)  
Packaging size: coil ≤ 30 kg or ≤ 250 m, otherwise drum  
PROFINET® is a registered trademark of the PNO (PROFIBUS user organisation)  
Detailed data sheets are available upon request. Please specify the type/dimensions of the required cable.  
Photographs are not to scale and do not represent detailed images of the respective products.



**Info**

- HYBRID: cable for data transmission + power supply

## ETHERLINE® Cat.5 FRNC HYBRID

Flexible use



### Benefits

- Industrial use
- Screened against interference

### Application range

- Industrial Ethernet cable
- 2pair: 10/100 Mbit/s for Industrial Ethernet
- High-quality, double screening ensures high transmission reliability in areas with electromagnetic interference
- PROFINET application Type B Hybrid
- Suitable for EtherCAT and EtherNet/IP applications

### Norm references / Approvals

- UL AWM Style 21282

### Design

- Cores for Power Supply  
4 x 1.5 mm<sup>2</sup> (AWG16)
- Data transfer: braided conductor, 7-wire, bare
- Screening: wrapped with foil and braided copper wires
- Twisting: data pairs and power supply pairs twisted together
- Overlapping plastic tape
- FRNC outer sheath
- Colour: green (based on RAL 6018)

### Technical data

- Minimum bending radius**  
Occasional flexing: 10 x outer diameter  
Fixed installation: 5 x outer diameter
- Test voltage**  
See data sheet
- Characteristic impedance**  
100 Ohm +- 15%
- Temperature range**  
Operation: -20 °C to +70 °C

### Product features

- Flame-retardant according IEC 60332-1-2
- HYBRID: cable for data transmission + power supply
- Robust, halogen-free outer sheath
- CAT.5-Performance

Article number	Article designation	Number of pairs and AWG per conductor	Max. outer diameter (mm)	Copper index (kg/km)	Weight (kg/km)
<b>Flexible use</b>					
2170887	ETHERLINE® Cat.5 FRNC HYBRID	2x2xAWG22/7 + 4x1.5	10.6	94.2	153

Unless specified otherwise, the shown product values are nominal values. Detailed values (e.g. tolerances) are available upon request. Please find our standard lengths at: [www.lappkabel.de/en/cable-standardlengths](http://www.lappkabel.de/en/cable-standardlengths)  
Packaging size: coil ≤ 30 kg or ≤ 250 m, otherwise drum  
PROFINET® is a registered trademark of the PNO (PROFIBUS user organisation)  
Detailed data sheets are available upon request. Please specify the type/dimensions of the required cable.  
Photographs are not to scale and do not represent detailed images of the respective products.



## ETHERLINE® PN Cat.5

### Fixed installation



**Info**

- For PROFINET applications type A
- CAT.5/5e

#### Benefits

- Can be used in dry or damp rooms
- Screened against interference
- Industrial use

#### Application range

- For industrial secondary and tertiary cabling according to EN 50173-3 ISO/IEC 24702
- Wiring of machines, tools, devices, appliances and control cabinets
- Fixed installation
- Suitable for EtherCAT and EtherNet/IP applications
- ETHERLINE® TRAY ER PN Y FC: installation in open cable trays and without any conduit

#### Product features

- Fixed installation
- FC: "Fast Connect" cable design
- Flame-retardant according IEC 60332-1-2
- ETHERLINE® Y FC, ETHERLINE® YY, ETHERLINE® TRAY ER PN Y FC : flame-retardant according to CSA FT-4
- CAT.5-Performance

#### Norm references / Approvals

- ETHERLINE® Y FC with PLTC approbation and AWM Style 21694
- ETHERLINE® PN Cat.5e YY with UL CMG
- ETHERLINE® PN Cat.5e Y with UL CMX
- ETHERLINE® TRAY ER PN Y FC with PLTC ER approval

#### Design

- Solid and bare copper conductor
- Core insulation: PE
- Star quad
- Overall screening with copper braid and plastic-laminated aluminium foil
- Outer sheath made of PVC
- Colour: green (based on RAL 6018)

#### Technical data

- Peak operating voltage**  
(not for power applications) 125 V
- Minimum bending radius**  
See data sheet
- Test voltage**  
See data sheet
- Characteristic impedance**  
100 Ohm +/- 15%
- Temperature range**  
See data sheet

Article number	Article designation	Number of pairs and AWG per conductor	Max. outer diameter (mm)	Copper index (kg/km)	Weight (kg/km)
<b>ETHERLINE® PN Cat.5</b>					
2170891	ETHERLINE® PN Cat.5e Y	2 x 2 x AWG22/1	6.5	30.4	56
<b>FC: "Fast Connect" cable design</b>					
2170893	ETHERLINE® Y FC UL/CSA (CMG) CAT.5	2 x 2 x AWG22/1	6.8	30.4	70
2170879	ETHERLINE® TRAY ER PN Y FC	2 x 2 x AWG22/1	6.8	30.4	70
<b>Suitable for outdoor use and direct burial</b>					
2170494	ETHERLINE® PN Cat.5e YY	2 x 2 x AWG22/1	7.8	30.4	62

Unless specified otherwise, the shown product values are nominal values. Detailed values (e.g. tolerances) are available upon request.

Please find our standard lengths at: [www.lappkabel.de/en/cable-standardlengths](http://www.lappkabel.de/en/cable-standardlengths)

Packaging size: coil ≤ 30 kg or ≤ 250 m, otherwise drum

PROFINET® is a registered trademark of the PNO (PROFIBUS user organisation)

Detailed data sheets are available upon request. Please specify the type/dimensions of the required cable.

Photographs are not to scale and do not represent detailed images of the respective products.

#### Accessories

- Connector RJ45 Cat.5e for Profinet refer to page 196
- Connector RJ45 angled Cat.5e for Profinet refer to page 196
- Easy Connect RJ45 Modul Cat.6<sub>A</sub> 10G refer to page 199
- BUS M12 connectors that can be assembled
- Connector industry RJ45 Cat.6<sub>A</sub> 10 IP68 refer to page 198





New

## ETHERLINE® PN FLEX

**Info**

- For Profinet applications
- CAT.5-Performance
- Flexible use



### Benefits

- Screened against interference
- For PROFINET applications type B
- Industrial use
- Can be used in dry or damp rooms

### Application range

- For industrial secondary and tertiary cabling according to EN 50173-3 ISO/IEC 24702
- For flexible applications (7-wire stranded conductor)
- Wiring of machines, tools, devices, appliances and control cabinets
- Suitable for EtherCAT and EtherNet/IP applications
- 2pair: 10/100 Mbit/s for Industrial Ethernet

### Product features

- Flame-retardant according to CSA FT4 UL Vertical-Tray Flame Test
- CAT.5-Performance
- FRNC Version: Halogene free and flame retardant
- Fast Connect (FC) cable design

### Norm references / Approvals

- The cable is UL/CSA-approved (CMG)

### Design

- Stranded 7-wire bare conductor
- Core insulation: PE
- Star quad
- Inner sheath made of PVC or FRNC
- Overall screening with copper braid and plastic-laminated aluminium foil
- PVC or FRNC jacket material
- Colour: green (based on RAL 6018)

### Technical data

- Peak operating voltage**  
(not for power applications) 125 V
- Minimum bending radius**  
Fixed installation: see data sheet
- Test voltage**  
Core/core: 2000 V  
Core/screen: 2000 V
- Characteristic impedance**  
100 Ohm +/- 15%
- Temperature range**  
See data sheet

Article number	Article designation	Number of pairs and AWG per conductor	Max. outer diameter (mm)	Copper index (kg/km)	Weight (kg/km)
<b>PVC sheath</b>					
2170886	ETHERLINE® PN Cat.5 Y FLEX FC	2 x 2 x AWG22/7	6.8	31.3	67
<b>FRNC outer sheath</b>					
2170890	ETHERLINE® PN Cat.5 FRNC FLEX FC	2 x 2 x AWG22/7	6.8	31.2	65

Unless specified otherwise, the shown product values are nominal values. Detailed values (e.g. tolerances) are available upon request.  
 Please find our standard lengths at: [www.lappkabel.de/en/cable-standardlengths](http://www.lappkabel.de/en/cable-standardlengths)  
 Packaging size: coil ≤ 30 kg or ≤ 250 m, otherwise drum  
 PROFINET® is a registered trademark of the PNO (PROFIBUS user organisation)  
 Detailed data sheets are available upon request. Please specify the type/dimensions of the required cable.  
 Photographs are not to scale and do not represent detailed images of the respective products.

### Accessories

- Connector RJ45 Cat.5e for Profinet refer to page 196
- Connector RJ45 angled Cat.5e for Profinet refer to page 196
- Easy Connect RJ45 Modul Cat.6<sub>A</sub> 10G refer to page 199
- BUS M12 connectors that can be assembled
- FC STRIP stripping tool



## ETHERLINE® PN Cat.5 FD

LAPP KABEL STUÏGART ETHERLINE® FD P FC Cat.5 2x2x22AWG



### Info

- Highly flexible application
- For PROFINET applications

### Benefits

- Screened against interference
- For PROFINET applications type C
- Industrial use
- Can be used in dry or damp rooms

### Application range

- Power chain applications
- Can be used for Industrial Ethernet in harsh industrial environments
- 2pair: 10/100 Mbit/s for Industrial Ethernet
- Suitable for EtherCAT and EtherNet/IP applications

### Product features

- PUR outer sheath is highly resistant to mineral oils and abrasion
- Flame-retardant according IEC 60332-1-2
- CAT.5-Performance
- Broad usages due to halogen-free materials

### Norm references / Approvals

- UL/CSA type CMX (UL 444)

### Design

- Stranded 7-wire bare conductor
- Star quad
- Colour-coded in accordance with PROFINET for Cat.5 applications
- Inner sheath: thermoplastic copolymer (FRNC)
- Overall screening with copper braid and plastic-laminated aluminium foil
- PUR outer sheath, halogen-free
- Colour: green (based on RAL 6018)

### Technical data



**Peak operating voltage**  
(not for power applications) 125 V



**Minimum bending radius**  
Flexing: 8 x outer diameter  
Fixed installation: 5 x cable diameter, once



**Test voltage**  
Core/core: 700 V  
Core/screen: 700 V



**Characteristic impedance**  
100 Ohm +/- 15%



**Temperature range**  
Fixed installation: -30°C to +70°C  
Flexing: -20°C to +60°C

Article number	Article designation	Number of pairs and AWG per conductor	Max. outer diameter (mm)	Copper index (kg/km)	Weight (kg/km)
<b>For highly flexible applications (7-wire stranded conductor) = type C</b>					
2170894	ETHERLINE® FD P FC CAT.5	2 x 2 x AWG22/7	6.8	31.3	63

Unless specified otherwise, the shown product values are nominal values. Detailed values (e.g. tolerances) are available upon request.

Please find our standard lengths at: [www.lappkabel.de/en/cable-standardlengths](http://www.lappkabel.de/en/cable-standardlengths)

Packaging size: coil ≤ 30 kg or ≤ 250 m, otherwise drum

PROFINET® is a registered trademark of the PNO (PROFIBUS user organisation)

Detailed data sheets are available upon request. Please specify the type/dimensions of the required cable.

Photographs are not to scale and do not represent detailed images of the respective products.

### Accessories

- Connector RJ45 Cat.5e for Profinet refer to page 196
- Connector RJ45 angled Cat.5e for Profinet refer to page 196
- BUS M12 connectors that can be assembled
- Connector industry RJ45 Cat.6<sub>A</sub> 10 IP68 refer to page 198



New

## ETHERLINE® Y Cat.5e BK 2x2AWG22/7



**Info**

- For PROFINET applications
- CAT.5-Performance

### Benefits

- UV and weather-resistant in black
- For PROFINET applications type B
- Can be used in dry or damp rooms

### Application range

- Many applications with Industrial Ethernet, e.g. PROFINET type B, i.e. fixed installation and flexible use.
- Suitable for EtherCAT and EtherNet/IP applications
- 2pair: 10/100 Mbit/s for Industrial Ethernet

### Product features

- PVC compound TM2 acc. to EN 50363-4-1
- Resistant to acids, alkalis and certain oils at room temperature
- Flame retardant acc. to IEC 60332-1-2
- CAT.5-Performance

### Design

- Stranded conductor, 7-wire, bare
- Core insulation: Based on Polyolefin
- Colour-coded in accordance with PROFINET for Cat.5 applications
- Star quad
- Overall screening with copper braid and plastic-laminated aluminium foil
- PVC outer sheath, black

### Technical data

- Peak operating voltage**  
(not for power applications) 125 V
- Minimum bending radius**  
Fixed installation: 10 x outer diameter  
Flexing: 15 x outer diameter
- Test voltage**  
Core/core: 1000 V  
Core/screen: 500 V
- Characteristic impedance**  
100 ± 15 Ohm (> 1 MHz)
- Temperature range**  
Flexing: -10°C to +70°C  
Fixed installation: -40°C to +80°C

Article number	Article designation	Number of pairs and AWG per conductor	Max. outer diameter (mm)	Copper index (kg/km)	Weight (kg/km)
ETHERLINE® Y Cat.5e BK 2x2AWG22/7					
2170901	ETHERLINE® Y CAT.5e BK 2x2xAWG22/7	2 x 2 x AWG22/7	6.5	30.4	59

Unless specified otherwise, the shown product values are nominal values. Detailed values (e.g. tolerances) are available upon request.  
 Copper price basis: EUR 150/100kg. Refer to catalogue appendix T17 for the definition and calculation of copper-related surcharges.  
 Please find our standard lengths at: [www.lappkabel.de/en/cable-standardlengths](http://www.lappkabel.de/en/cable-standardlengths)  
 Packaging size: coil ≤ 30 kg or ≤ 250 m, otherwise drum  
 Please specify the preferred type of packaging (e.g. 1 x 500 m drum or 5 x 100 m coils).  
 PROFINET® is a registered trademark of the PNO (PROFIBUS user organisation)  
 Photographs are not to scale and do not represent detailed images of the respective products.

### Similar products

- ETHERLINE® PN FLEX refer to page 159

### Accessories

- Connector RJ45 Cat.5e for Profinet refer to page 196
- Connector RJ45 angled Cat.5e for Profinet refer to page 196
- BUS M12 connectors that can be assembled
- Easy connect rail mount adapter Cat.6<sub>A</sub> refer to page 200
- DATA STRIP stripping tool



## ETHERLINE® TORSION Cat. 5



Info

- Industrial Ethernet Cable, 2-pair, suitable for torsion stress
- For PROFINET applications

### Benefits

- For PROFINET applications type C
- Industrial Ethernet Cable, 2-pair, suitable for torsion stress
- Industrial use
- Can be used in dry or damp rooms

### Application range

- Many applications with Industrial Ethernet, e.g. PROFINET, i.e. fixed installation, flexible use as well as TORSION.
- Plant engineering, machinery manufacturing
- Suitable for EtherCAT and EtherNet/IP applications

### Product features

- Cable suitable for high torsion stress. Tested with more than 1 million bending cycles and a right/left movement of 180° per metre.
- Outer sheath with high abrasion-resistance
- CAT.5-Performance

### Norm references / Approvals

- UL AWM (Style 21161)
- Halogen-free according to VDE 0472-815
- Flame retardant acc. to IEC 60332-1-2

### Design

- Stranded conductor, tinned
- AWG 22 (19-wire)
- PE core insulation
- Star quad
- Screening: wrapped with braided tinned-copper wires
- Non-woven wrapping
- PUR outer sheath, green (RAL 6018)

### Technical data

- Peak operating voltage**  
max. 100 V (not for power applications)
- Minimum bending radius**  
Installation: 5 x outer diameter
- Test voltage**  
700 V
- Characteristic impedance**  
100 ± 15 Ohm (> 1 MHz)
- Temperature range**  
-40°C to +80°C

Article number	Article designation	Number of pairs and AWG per conductor	Outer diameter (mm)	Copper index (kg/km)	Weight (kg/km)
<b>ETHERLINE® TORSION CAT.5</b>					
2170888	ETHERLINE® TORSION CAT.5	2 x 2 x AWG22/19	6.8	31.3	52

Unless specified otherwise, the shown product values are nominal values. Detailed values (e.g. tolerances) are available upon request.  
 Copper price basis: EUR 150/100kg. Refer to catalogue appendix T 17 for the definition and calculation of copper-related surcharges.  
 Please find our standard lengths at: [www.lappkabel.de/en/cable-standardlengths](http://www.lappkabel.de/en/cable-standardlengths)  
 Packaging size: coil ≤ 30 kg or ≤ 250 m, otherwise drum  
 Please specify the preferred type of packaging (e.g. 1 x 500 m drum or 5 x 100 m coils).  
 PROFINET® is a registered trademark of the PNO (PROFIBUS user organisation)  
 Photographs are not to scale and do not represent detailed images of the respective products.

### Accessories

- Connector RJ45 Cat.5e for Profinet refer to page 196
- Connector RJ45 angled Cat.5e for Profinet refer to page 196
- BUS M12 connectors that can be assembled
- Easy connect rail mount adapter Cat.6<sub>A</sub> refer to page 200
- Multipurpose shears A and B
- SMART STRIP stripping tool



**New**

## ETHERLINE® Cat.5e 105 plus



**Info**

- For PROFINET applications
- Extended temperature range

**Benefits**

- No need for additional cable protection against high temperatures
- High temperature resistance
- Industrial use
- Premium screening against electro-magnetic interference

**Application range**

- For installation in hollow shaft between gear units and pitch system
- Suitable for fixed installation and occasionally flexible use in high temperature areas
- For PROFINET applications type B
- Suitable for EtherCAT and EtherNet/IP applications

**Product features**

- Optimum EMC protection
- Permanent load up to +105°C, temporary load +120°C

**Norm references / Approvals**

- Electrical requirements acc. to IEC 61156-5

**Design**

- Stranded conductor, 7-wire, bare
- Core insulation: PE
- Colour-coded in accordance with PROFINET for Cat.5 applications
- Overall screening with copper braid and plastic-laminated aluminium foil
- Outer sheath: TPE-based
- Colour: green (based on RAL 6018)

**Technical data**

- Minimum bending radius**  
Fixed installation: 10 x outer diameter  
Flexing: 15 x outer diameter
- Characteristic impedance**  
100 Ohm +/- 15%
- Temperature range**  
Fixed installation: -40°C to +105°C  
occasionally flexing: -30°C to +105°C

Article number	Article designation	Number of pairs and AWG per conductor	Max. outer diameter (mm)	Copper index (kg/km)
2170636	ETHERLINE Cat.5e 105 plus	2x2xAWG22/7	6.5	30.4

Unless specified otherwise, the shown product values are nominal values. Detailed values (e.g. tolerances) are available upon request.  
 PROFINET® is a registered trademark of the PNO (PROFIBUS user organisation)  
 Detailed data sheets are available upon request. Please specify the type/dimensions of the required cable.  
 Photographs are not to scale and do not represent detailed images of the respective products.

**Accessories**

- Connector RJ45 Cat.5e for Profinet refer to page 196
- Connector RJ45 angled Cat.5e for Profinet refer to page 196
- Easy Connect RJ45 Modul Cat.6<sub>A</sub> 10G refer to page 199
- BUS M12 connectors that can be assembled





## ETHERLINE® Cat.6<sub>A</sub> + Cat.7

Fixed installation



**Info**

- Industrial Ethernet cable
- For PROFINET applications with 4 pairs
- CAT.6<sub>A</sub> and Cat.7 qualified for 10Gbit/s

### Benefits

- Screened against interference
- Industrial use
- Can be used for Industrial Ethernet in harsh industrial environments

### Application range

- For industrial secondary and tertiary cabling according to EN 50173-3 ISO/IEC 24702
- Fixed installation
- Can be used in dry or damp rooms
- For PROFINET applications type A

### Product features

- PUR outer sheath is highly resistant to mineral oils and abrasion
- Robust, halogen-free outer sheath
- PVC sheath
- High-quality, double screening ensures high transmission reliability in areas with electromagnetic interference

### Design

- Solid bare copper wire AWG22
- Core insulation made of polyethylene (PE)
- S/FTP: copper braid as overall screening and pair screening with aluminium compound foil
- Colour: green (based on RAL 6018)

### Technical data

- Peak operating voltage**  
(not for power applications) 125 V
- Minimum bending radius**  
Fixed installation: see data sheet
- Characteristic impedance**  
100 ohm at 1 - 100 MHz
- Temperature range**  
See data sheet

Article number	Article designation	Number of pairs and AWG per conductor	Max. outer diameter (mm)	Copper index (kg/km)	Weight (kg/km)
<b>Outer sheath: halogen-free, flame-retardant compound</b>					
2170466	ETHERLINE® Cat.6 <sub>A</sub> H	4 x 2 x AWG22/1	9.0	53.0	99
2170476	ETHERLINE® CAT.7 H	4 x 2 x AWG22/1	9.0	53.0	99
<b>Outer sheath: PUR, halogen-free</b>					
2170465	ETHERLINE® CAT.6 <sub>A</sub> P	4 x 2 x AWG22/1	9.0	53.0	91
2170475	ETHERLINE® Cat.7 P	4 x 2 x AWG22/1	9.0	53.0	91
<b>Outer sheath: PVC</b>					
2170464	ETHERLINE® Cat.6 <sub>A</sub> Y	4 x 2 x AWG22/1	9.0	53.0	98
2170474	ETHERLINE® Cat.7 Y	4 x 2 x AWG22/1	9.0	53.0	98

Copper price basis: EUR 150/100kg. Refer to catalogue appendix T17 for the definition and calculation of copper-related surcharges.

Please find our standard lengths at: [www.lappkabel.de/en/cable-standardlengths](http://www.lappkabel.de/en/cable-standardlengths)

Packaging size: coil ≤ 30 kg or ≤ 250 m, otherwise drum

Please specify the preferred type of packaging (e.g. 1 x 500 m drum or 5 x 100 m coils).

PROFINET® is a registered trademark of the PNO (PROFIBUS user organisation)

Photographs are not to scale and do not represent detailed images of the respective products.

### Accessories

- Easy Connect RJ45 Modul Cat.6<sub>A</sub> 10G refer to page 199
- Connector RJ45 Cat.6<sub>A</sub> fieldmountable refer to page 197
- Connector RJ45 angled Cat.6<sub>A</sub> fieldmountable refer to page 197
- Connector M12 x-coded Cat.6<sub>A</sub> 10G fieldmountable refer to page 198
- EPIC® DATA CCR FA refer to page 199
- DATA STRIP stripping tool

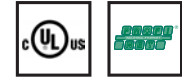

New

## ETHERLINE® PN Cat.6<sub>A</sub> FLEX



**Info**

- For PROFINET applications with 4 pairs



**Benefits**

- For PROFINET applications type B
- Screened against interference
- Industrial use
- Can be used in dry or damp rooms

**Application range**

- For industrial secondary and tertiary cabling according to EN 50173-3 ISO/IEC 24702
- For flexible applications (7-wire stranded conductor)
- Plant engineering, machinery manufacturing
- Suitable for EtherCAT and EtherNet/IP applications

**Product features**

- CAT.6<sub>A</sub> for flexible application, qualified for 10Gbit/s
- Meets the requirements according to CAT.6<sub>A</sub>, ISO/IEC 11801 and EN 50173
- High-quality, double screening ensures high transmission reliability in areas with electromagnetic interference

**Norm references / Approvals**

- The cable is UL/CSA-approved (CMG)

**Design**

- Stranded 7-wire bare conductor
- Core insulation: PE
- S/FTP: copper braid as overall screening and pair screening with aluminium compound foil
- PVC or FRNC jacket material
- Colour: green (based on RAL 6018)

**Technical data**

- Peak operating voltage**  
(not for power applications) 125 V
- Minimum bending radius**  
Fixed installation: see data sheet
- Characteristic impedance**  
100 ± 15 Ohm (> 1 MHz)
- Temperature range**  
Operation: see data sheet

Article number	Article designation	Number of pairs and AWG per conductor	Max. outer diameter (mm)	Copper index (kg/km)	Weight (kg/km)
<b>PVC outer sheath</b>					
2170930	ETHERLINE PN Cat.6 <sub>A</sub> Y FLEX	4 x 2 x AWG23/7	9.0	48.0	92
<b>FRNC outer sheath</b>					
2170931	ETHERLINE PN Cat.6 <sub>A</sub> FRNC FLEX	4 x 2 x AWG23/7	9.0	48.0	87

Unless specified otherwise, the shown product values are nominal values. Detailed values (e.g. tolerances) are available upon request.

PROFINET® is a registered trademark of the PNO (PROFIBUS user organisation)

Detailed data sheets are available upon request. Please specify the type/dimensions of the required cable.

Photographs are not to scale and do not represent detailed images of the respective products.

**Accessories**

- Easy Connect RJ45 Modul Cat.6<sub>A</sub> 10G refer to page 199
- Connector RJ45 Cat.6<sub>A</sub> fieldmountable refer to page 197
- Connector RJ45 angled Cat.6<sub>A</sub> fieldmountable refer to page 197
- Connector industry RJ45 Cat.6<sub>A</sub> 10 IP68 refer to page 198
- DATA STRIP stripping tool



New

## ETHERLINE® FD CAT.6<sub>A</sub>



**Info**

- CAT.6<sub>A</sub> for drag chain, qualified for 10Gbit/s
- For PROFINET applications with 4 pairs

### Benefits

- For use in power chains and moving machinery parts in dry or damp rooms
- Many applications with Industrial Ethernet, e.g. PROFINET, i.e. fixed installation, flexible and highly flexible use
- Premium screening against electromagnetic interference

### Application range

- For highly flexible applications (e.g. power chains)
- Can be used for Industrial Ethernet in harsh industrial environments
- Suitable for EtherCAT and EtherNet/IP applications
- For PROFINET applications type C

### Product features

- PUR version is halogen-free according to IEC 60754
- Oil-resistant
- CAT.6<sub>A</sub> for drag chain, qualified for 10Gbit/s
- Meets the requirements according to CAT.6<sub>A</sub>, ISO/IEC 11801 and EN 50173
- Designed for 1...2 million bending/unbending cycles in the power chain

### Norm references / Approvals

- Electrical requirements acc. to IEC 61156-6
- UL/CSA type CMX in accordance with UL 444 and CSA C22.2 no. 214-02

### Design

- 7-wire tinned stranded copper conductor
- Core insulation: Based on Polyolefin
- S/FTP: copper braid as overall screening and pair screening with aluminium compound foil
- Outer sheath: PUR, halogen-free/PVC
- Colour: green (based on RAL 6018)

### Technical data



**Minimum bending radius**  
Flexing: 15 x outer diameter



**Characteristic impedance**  
100 Ohm



**Temperature range**  
Fixed installation: -40°C to +80°C  
Flexing: -10°C to +70°C

Article number	Article designation	Number of pairs and AWG per conductor	Max. outer diameter (mm)	Copper index (kg/km)
<b>PVC sheath</b>				
2170485	ETHERLINE® FD CAT.6 <sub>A</sub>	4x2xAWG24/7	9.0	44.0
<b>Outer sheath: PUR, halogen-free</b>				
2170484	ETHERLINE® FD P CAT.6 <sub>A</sub>	4x2xAWG24/7	9.0	44.0

Unless specified otherwise, the shown product values are nominal values. Detailed values (e.g. tolerances) are available upon request. PROFINET® is a registered trademark of the PNO (PROFIBUS user organisation). Detailed data sheets are available upon request. Please specify the type/dimensions of the required cable. Photographs are not to scale and do not represent detailed images of the respective products.



New

## ETHERLINE® TORSION Cat.6<sub>A</sub>

LAPP KABEL STUÏTGART ETHERLINE® Cat.6<sub>A</sub> Torsion 4x2xAWG24/7



### Info

- Industrial Ethernet Cable, 4-pair, suitable for torsion stress
- CAT.6<sub>A</sub> qualified for 10Gbit/s
- For PROFINET applications

### Benefits

- Cable suitable for high torsion stress. Tested with more than 1 million bending cycles and a right/left movement of 180° per metre.
- Many applications with Industrial Ethernet, e.g. PROFINET, i.e. fixed installation, flexible use as well as TORSION.
- Premium screening against electromagnetic interference

### Application range

- Suitable for torsional applications which are typical for the loop in wind turbine generators (WTG)
- Can be used for Industrial Ethernet in harsh industrial environments
- Suitable for EtherCAT and EtherNet/IP applications
- For PROFINET applications type C

### Product features

- Oil-resistant acc. EN 60811-2-1
- PUR outer sheath, halogen-free



### Norm references / Approvals

- Electrical requirements acc. to IEC 61156-6
- UL/CSA type CMX in accordance with UL 444 and CSA C22.2 no. 214-02

### Design

- 7-wire tinned stranded copper conductor
- Core insulation made of polyethylene (PE)
- S/FTP: copper braid as overall screening and pair screening with aluminium compound foil
- Outer sheath: PUR, halogen-free/PVC
- Colour: green (based on RAL 6018)

### Technical data

-  **Minimum bending radius**  
Flexing: 15 x outer diameter
-  **Characteristic impedance**  
100 Ohm
-  **Temperature range**  
Fixed installation: -40°C to +80°C  
Flexing: -10°C to +70°C

Article number	Article designation	Number of pairs and AWG per conductor	Max. outer diameter (mm)	Copper index (kg/km)
<b>PVC sheath</b>				
2170482	ETHERLINE® TORSION Y CAT6 <sub>A</sub>	4 x 2 x AWG24/7	9.0	44.0
<b>Outer sheath: PUR, halogen-free</b>				
2170483	ETHERLINE® TORSION P CAT6 <sub>A</sub>	4 x 2 x AWG24/7	9.0	44.0

Unless specified otherwise, the shown product values are nominal values. Detailed values (e.g. tolerances) are available upon request. PROFINET® is a registered trademark of the PNO (PROFIBUS user organisation). Detailed data sheets are available upon request. Please specify the type/dimensions of the required cable. Photographs are not to scale and do not represent detailed images of the respective products.



## ETHERLINE® CAT.6 FD



**Info**  

- CAT.6 for drag chain!



### Benefits

- Highly flexible data cable with PUR outer sheath, meets the highest service life requirements, even under harsh climatic conditions.
- Premium screening against electromagnetic interference

### Application range

- For use in power chains and moving machinery parts in dry or damp rooms
- Only for patch cable applications (max. 60 m)
- Suitable for EtherCAT and EtherNet/IP applications
- Plant engineering, machinery manufacturing
- 4pair: 10 / 100 / 1000 Mbit/s for Industrial Ethernet

### Product features

- Flame-retardant according IEC 60332-1-2
- PUR outer sheath is resistant to most oils and hydraulic fluids
- CAT.6 for drag chain!
- LAN Cat.6 cables are specified up to 350 MHz
- Designed for 1...2 million bending/unbending cycles in the power chain

### Norm references / Approvals

- UL/GSA type CMX (UL 444)

### Design

- Stranded conductor, tinned
- AWG 26 (19-wire)
- PP core insulation
- Inner sheath: thermoplastic copolymer (FRNC)
- SF/UTP: copper braid and foil screening as overall screening
- PUR outer sheath, halogen-free
- Colour: green (based on RAL 6018)

### Technical data

- Peak operating voltage**  
max. 100 V (not for power applications)
- Minimum bending radius**  
Fixed installation: 4 x outer diameter  
Flexing: 7.5 x outer diameter
- Test voltage**  
700 V
- Characteristic impedance**  
At 1 - 100 MHz: 100 ± 15 Ohm
- Temperature range**  
Fixed installation: -40°C to +80°C  
Flexing: -30°C to +80°C

Article number	Article designation	Number of pairs and AWG per conductor	Max. outer diameter (mm)	Copper index (kg/km)	Weight (kg/km)
<b>ETHERLINE® CAT.6 FD</b>					
2170488	ETHERLINER CAT.6 FD	4 x 2 x AWG26/19	7.8	31.7	63

Unless specified otherwise, the shown product values are nominal values. Detailed values (e.g. tolerances) are available upon request.  
 Copper price basis: EUR 150/100kg. Refer to catalogue appendix T 17 for the definition and calculation of copper-related surcharges.  
 Please find our standard lengths at: [www.lappkabel.de/en/cable-standardlengths](http://www.lappkabel.de/en/cable-standardlengths)  
 Packaging size: coil ≤ 30 kg or ≤ 250 m, otherwise drum  
 Please specify the preferred type of packaging (e.g. 1 x 500 m drum or 5 x 100 m coils).  
 Photographs are not to scale and do not represent detailed images of the respective products.

### Accessories

- Field-Terminable Connector RJ45 CAT.5e FM45 refer to page 195
- Connector RJ45 Cat.6<sub>A</sub> FM for FD-cables
- Connector M12 x-coded Cat.6<sub>A</sub> 10G fieldmountable refer to page 198
- EPIC® DATA CCR FA refer to page 199
- DATA STRIP stripping tool





New

## ETHERLINE® EC FLEX Cat.5e



**Info**

- For EtherCAT applications

### Benefits

- Can be used for Industrial Ethernet in harsh industrial environments
- Can be used in dry or damp rooms
- Lower space requirement

### Application range

- Suitable for EtherCAT and EtherNet/IP applications
- For flexible applications (7-wire stranded conductor)
- Many applications with Industrial Ethernet, i.e. fixed installation and flexible use.
- For internal wiring of electric and electronic equipment in switch cabinets

### Product features

- PUR (Polyurethane) Version with increased robustness, UV- resistance and halogen free
- Meets the requirements according to CAT.5e, ISO/IEC 11801 and EN 50173, Class D
- High-quality, double screening ensures high transmission reliability in areas with electromagnetic interference

### Norm references / Approvals

- Approval: UL/CSA type CMX in accordance with UL 444 and CSA C22.2 no. 214

### Design

- Stranded tinned 7-wire conductor
- Core insulation: PE
- Insulation colour-codes: orange/white-orange; green/white-green
- Star quad
- SF/UTP: copper braid and foil screening as overall screening
- PVC or PUR jacket material
- Colour: green (based on RAL 6018)

### Technical data

- Peak operating voltage**  
max. 100 V (not for power applications)
- Minimum bending radius**  
Fixed installation: 4 x outer diameter  
Flexing: 8 x outer diameter
- Characteristic impedance**  
100 Ohm +/- 15%
- Temperature range**  
fixed installation  
PVC: -30°C to +80°C  
PUR: -40°C to +80°C  
Flexing  
PVC: -5°C to +50°C  
PUR: -30°C to +50°C

Article number	Article designation	Number of pairs and AWG per conductor	Max. outer diameter (mm)	Copper index (kg/km)	Weight (kg/km)
<b>PVC outer sheath</b>					
2170430	ETHERLINE® Y EC FLEX Cat.5e	1 x 4 x AWG26/7	5.0	20.0	37
<b>Outer sheath: PUR, halogen-free</b>					
2170431	ETHERLINE® P EC FLEX Cat.5e	1 x 4 x AWG26/7	5.0	20.0	35

Unless specified otherwise, the shown product values are nominal values. Detailed values (e.g. tolerances) are available upon request. Detailed data sheets are available upon request. Please specify the type/dimensions of the required cable. Photographs are not to scale and do not represent detailed images of the respective products.

### Accessories

- Field mountable S/A connectors M8 refer to page 114
- Field-Terminable Connector RJ45 CAT.5e FM45 refer to page 195
- Connector RJ45 Cat.5e for Profinet refer to page 196
- Connector RJ45 angled Cat.5e for Profinet refer to page 196
- BUS M12 connectors that can be assembled



New

## ETHERLINE® EC FD Cat.5e

LAPP KABEL STÜTTGART ETHERLINE® P EC FD Cat.5e



Info

- For EtherCAT applications
- For highly flexible industrial applications

### Benefits

- Can be used for Industrial Ethernet in harsh industrial environments
- Can be used in dry or damp rooms
- Lower space requirement

### Application range

- Suitable for EtherCAT and EtherNet/IP applications
- For highly flexible applications (power chains, moving machine parts)
- Many applications with Industrial Ethernet, e.g. EtherCat, i.e. fixed installation, flexible and highly flexible use
- For internal wiring of electric and electronic equipment in switch cabinets

### Product features

- PUR outer sheath, halogen-free
- Meets the requirements according to CAT.5e, ISO/IEC 11801 and EN 50173, Class D
- High-quality, double screening ensures high transmission reliability in areas with electromagnetic interference

### Norm references / Approvals

- UL/CSA type CMX in accordance with UL 444 and CSA C22.2 no. 214-02

### Design

- AWG 26 (19-wire)
- Core insulation: PE
- Insulation colour-codes: orange/white-orange; green/white-green
- Star quad
- SF/UTP: copper braid and foil screening as overall screening
- Outer sheath: PUR compound, halogen-free
- Colour: green (based on RAL 6018)

### Technical data



#### Minimum bending radius

Fixed installation: 4 x Outer diameter  
Flexing: 8 x outer diameter



#### Characteristic impedance

100 Ohm +/- 15%



#### Temperature range

Fixed installation: -40°C to +80°C  
Flexing: -30°C to +50°C

Article number	Article designation	Number of pairs and AWG per conductor	Max. outer diameter (mm)	Copper index (kg/km)	Weight (kg/km)
<b>ETHERLINE® EC FD Cat.5e</b>					
2170432	ETHERLINE® P EC FD Cat.5e	1 x 4 x AWG26/19	5.0	20.0	35

Unless specified otherwise, the shown product values are nominal values. Detailed values (e.g. tolerances) are available upon request. Detailed data sheets are available upon request. Please specify the type/dimensions of the required cable. Photographs are not to scale and do not represent detailed images of the respective products.

### Accessories

- Field mountable S/A connectors M8 refer to page 114
- Field-Terminable Connector RJ45 CAT.5e FM45 refer to page 195
- BUS M12 connectors that can be assembled



**New**

## ETHERLINE® MARINE FRNC FC CAT.5

LAPP KABEL STUTTGART ETHERLINE® MARINE FRNC FC Cat.5



**Info**

- Certified for maritime applications

**Benefits**

- Can be used for Industrial Ethernet in harsh industrial environments
- For use in dry, damp and wet rooms

**Application range**

- Shipbuilding
- For PROFINET applications type B
- Suitable for EtherCAT and EtherNet/IP applications
- Onshore and offshore applications

**Product features**

- High flame retardancy in accordance with IEC 60332-3 and FT4
- CAT.5-Performance
- Fast Connect (FC) cable design

**Norm references / Approvals**

- CMG UL/CSA approval 75°C or PLTC, Sun Res

**Design**

- Fine-wire strand made of tinned-copper wires
- Colour-coded in accordance with PROFINET for Cat.5 applications
- Star quad
- Inner sheath: thermoplastic copolymer (FRNC)
- SF/UTP: copper braid and foil screening as overall screening
- Halogen-free and flame-retardant FRNC outer sheath
- Colour: green (based on RAL 6018)

**Technical data**

- Peak operating voltage**  
(not for power applications) 125 V
- Minimum bending radius**  
Fixed installation: 3 x outer diameter  
Flexing: 7.5 x outer diameter
- Characteristic impedance**  
100 Ohm +/- 15%
- Temperature range**  
Operating temperature: -25°C to +70°C  
During installation: 0 °C to +50 °C

Article number	Article designation	Number of pairs and AWG per conductor	Max. outer diameter (mm)	Copper index (kg/km)	Weight (kg/km)
<b>ETHERLINE® MARINE FRNC FC CAT.5</b>					
2170889	ETHERLINE® MARINE FRNC FC CAT.5	2 x 2 x AWG22/7	6.5	32.0	68

Unless specified otherwise, the shown product values are nominal values. Detailed values (e.g. tolerances) are available upon request.

PROFINET® is a registered trademark of the PNO (PROFIBUS user organisation)

Detailed data sheets are available upon request. Please specify the type/dimensions of the required cable.

Photographs are not to scale and do not represent detailed images of the respective products.

**Accessories**

- Connector RJ45 Cat.5e for Profinet refer to page 196
- Connector RJ45 angled Cat.5e for Profinet refer to page 196
- BUS M12 connectors that can be assembled
- FC STRIP stripping tool



New

## ETHERLINE® FIRE Cat.5e PH60

LAPP KABEL STUTTGART ETHERLINE® FIRE Cat.5e 4x2xAWG23/1



Info

- Isolation integrity for at least 60 minutes in the event of fire

### Benefits

- Ensures that the cable can still transmit data during and after a fire (according to EN50200)
- High-quality, double screening ensures high transmission reliability in areas with electromagnetic interference

### Application range

- In industrial areas that use fire as a tool
- Highly combustible or fire-prone areas
- For fixed installation
- For indoor use

### Product features

- Fire behaviour:
  - Halogen-free (IEC 60754-1 & EN50267-2-1)
  - Flame-retardant (IEC 60332-1)
  - Fire retardant (IEC 60332-3-24)
  - Low smoke density (IEC 61034-2)
  - Circuit integrity (EN50200); 60 min
- Meets the requirements according to CAT.5e, ISO/IEC 11801 and EN 50173, Class D

### Design

- Solid, bare, single-wire copper conductor
- Core insulation: Based on Polyolefin
- Each insulation will be wrapped with a special tape (anti-fire barrier)
- Twisting: 2 twisted-pair cores, stranding from 4 pairs
- F/UTP: foil screening as overall screening
- Halogen-free and flame-retardant FRNC outer sheath, colour: red (similar to RAL3000)

### Technical data



**Peak operating voltage**  
(not for power applications) 125 V



**Minimum bending radius**  
Fixed installation: 15 x cable diameter



**Characteristic impedance**  
100 Ohm +/- 15%



**Temperature range**  
Operation: -20 °C to +70 °C

Article number	Article designation	Number of pairs and AWG per conductor	Max. outer diameter (mm)	Copper index (kg/km)	Weight (kg/km)
<b>ETHERLINE® FIRE Cat.5e PH60</b>					
2170904	ETHERLINE® FIRE Cat.5e PH60	4 x 2 x AWG23/1	8.3	24.0	75

Unless specified otherwise, the shown product values are nominal values. Detailed values (e.g. tolerances) are available upon request. Detailed data sheets are available upon request. Please specify the type/dimensions of the required cable. Photographs are not to scale and do not represent detailed images of the respective products.



**New**

## Industrial Ethernet PN A patchcord M12



Info

- For PROFINET applications (D-coded)



### Benefits

- Non-permanent connections allow for easy change of equipment
- For directly connecting two electric components
- CAT.5-Performance

### Application range

- For PROFINET applications type A
- Fixed installation
- Suitable for EtherCAT and EtherNet/IP applications
- Suitable for use in industrial applications
- For indoor use

### Product features

- CAT.5-Performance
- Meets the requirements according to CAT.5e, ISO/IEC 11801 and EN 50173, Class D
- 2pair: 10/100 Mbit/s for Industrial Ethernet

### Norm references / Approvals

- The cable is UL/CSA-approved (CMG)
- UL File Number: E249137

### Design

- Solid and bare copper conductor
- Star quad
- Overall screening with copper braid and plastic-laminated aluminium foil
- Outer sheath made of PVC
- Colour: green (based on RAL 6018)
- Pre-assembled patchcord with a M12 D-coded connector on both sides
- 4 pole M12 connector with vibration protection

### Technical data

- Minimum bending radius**  
During installation: 15 x outer diameter  
Fixed installation: 10 x outer diameter
- Protection rating**  
IP 67 / IP 69K
- Characteristic impedance**  
100 Ohm +/- 15%
- Temperature range**  
During installation: -20°C to +60°C  
Fixed installation: -40°C to +80°C

Article number	Article designation	Number of pairs and AWG per conductor	Length (m)	Copper index (kg/km)
<b>Straight connector on straight connector</b>				
2171001	IE-PNA-5-M12D-S-1-Y-2-22-1-M12D-S	2x2xAWG22	1.0	30.4
2171002	IE-PNA-5-M12D-S-2-Y-2-22-1-M12D-S	2x2xAWG22	2.0	60.8
2171003	IE-PNA-5-M12D-S-3-Y-2-22-1-M12D-S	2x2xAWG22	3.0	91.2
2171004	IE-PNA-5-M12D-S-5-Y-2-22-1-M12D-S	2x2xAWG22	5.0	152.0
2171005	IE-PNA-5-M12D-S-10-Y-2-22-1-M12D-S	2x2xAWG22	10.0	304.0
2171006	IE-PNA-5-M12D-S-20-Y-2-22-1-M12D-S	2x2xAWG22	20.0	608.0
<b>Angled connector on straight connector</b>				
2171013	IE-PNA-5-M12D-A-1-Y-2-22-1-M12D-S	2x2xAWG22	1.0	30.4
2171014	IE-PNA-5-M12D-A-2-Y-2-22-1-M12D-S	2x2xAWG22	2.0	60.8
2171015	IE-PNA-5-M12D-A-3-Y-2-22-1-M12D-S	2x2xAWG22	3.0	91.2
2171016	IE-PNA-5-M12D-A-5-Y-2-22-1-M12D-S	2x2xAWG22	5.0	152.0
2171017	IE-PNA-5-M12D-A-10-Y-2-22-1-M12D-S	2x2xAWG22	10.0	304.0
2171018	IE-PNA-5-M12D-A-20-Y-2-22-1-M12D-S	2x2xAWG22	20.0	608.0

Unless specified otherwise, the shown product values are nominal values. Detailed values (e.g. tolerances) are available upon request.  
Copper price basis: EUR 150/100kg. Refer to catalogue appendix T17 for the definition and calculation of copper-related surcharges.  
Other lengths and types of connectors are available upon request.  
Photographs are not to scale and do not represent detailed images of the respective products.  
For detailed technical information please refer to the data sheet





## Industrial Ethernet PN A Patchcord M12 on free conductor end



**Info**

- For PROFINET applications (D-coded)

### Benefits

- Non-permanent connections allow for easy change of equipment
- For directly connecting two electric components
- CAT.5-Performance
- Suitable for direct connector assembly

### Application range

- For PROFINET applications type A
- Fixed installation
- Suitable for EtherCAT and EtherNet/IP applications
- Suitable for use in industrial applications
- For indoor use

### Product features

- CAT.5-Performance
- Meets the requirements according to CAT.5e, ISO/IEC 11801 and EN 50173, Class D
- 2pair: 10/100 Mbit/s for Industrial Ethernet

### Norm references / Approvals

- The cable is UL/CSA-approved (CMG)
- UL File Number: E249137

### Design

- Solid and bare copper conductor
- Star quad
- Overall screening with copper braid and plastic-laminated aluminium foil
- Outer sheath made of PVC
- Colour: green (based on RAL 6018)
- Pre-assembled patchcord with a M12 connector on free conductor end
- 4 pole M12 connector with vibration protection

### Technical data

- Minimum bending radius**  
During installation: 15 x outer diameter  
Fixed installation: 10 x outer diameter
- Protection rating**  
IP 67 / IP 69K
- Characteristic impedance**  
100 Ohm +/- 15%
- Temperature range**  
During installation: -20°C to +60°C  
Fixed installation: -40°C to +80°C

Article number	Article designation	Number of pairs and AWG per conductor	Length (m)	Copper index (kg/km)
<b>straight connector on free conductor end</b>				
2171007	IE-PNA-5-M12D-S-1-Y-2-22-1-OE	2x2xAWG22	1.0	30.4
2171008	IE-PNA-5-M12D-S-2-Y-2-22-1-OE	2x2xAWG22	2.0	60.8
2171009	IE-PNA-5-M12D-S-3-Y-2-22-1-OE	2x2xAWG22	3.0	91.2
2171010	IE-PNA-5-M12D-S-5-Y-2-22-1-OE	2x2xAWG22	5.0	152.0
2171011	IE-PNA-5-M12D-S-10-Y-2-22-1-OE	2x2xAWG22	10.0	304.0
2171012	IE-PNA-5-M12D-S-20-Y-2-22-1-OE	2x2xAWG22	20.0	608.0
<b>Angled connector on free conductor end</b>				
2171019	IE-PNA-5-M12D-A-1-Y-2-22-1-OE	2x2xAWG22	1.0	30.4
2171020	IE-PNA-5-M12D-A-2-Y-2-22-1-OE	2x2xAWG22	2.0	60.8
2171021	IE-PNA-5-M12D-A-3-Y-2-22-1-OE	2x2xAWG22	3.0	91.2
2171022	IE-PNA-5-M12D-A-5-Y-2-22-1-OE	2x2xAWG22	5.0	152.0
2171023	IE-PNA-5-M12D-A-10-Y-2-22-1-OE	2x2xAWG22	10.0	304.0
2171024	IE-PNA-5-M12D-A-20-Y-2-22-1-OE	2x2xAWG22	20.0	608.0

Unless specified otherwise, the shown product values are nominal values. Detailed values (e.g. tolerances) are available upon request.  
Copper price basis: EUR 150/100kg. Refer to catalogue appendix T17 for the definition and calculation of copper-related surcharges.  
Other lengths and types of connectors are available upon request.  
Photographs are not to scale and do not represent detailed images of the respective products.

### Accessories

- Connector RJ45 Cat.5e for Profinet refer to page 196
- Connector RJ45 angled Cat.5e for Profinet refer to page 196
- BUS M12 connectors that can be assembled



## Industrial Ethernet PN B patchcord M12

**Info**

- For PROFINET applications (D-coded)



### Benefits

- Non-permanent connections allow for easy change of equipment
- For directly connecting two electric components
- CAT.5-Performance

### Application range

- For PROFINET applications type B
- Flexible use
- Suitable for EtherCAT and EtherNet/IP applications
- Suitable for use in industrial applications
- For indoor use

### Product features

- CAT.5-Performance
- Meets the requirements according to CAT.5e, ISO/IEC 11801 and EN 50173, Class D
- 2pair: 10/100 Mbit/s for Industrial Ethernet

### Norm references / Approvals

- The cable is UL/CSA-approved (CMG)
- UL File Number: E249137

### Design

- Flexible fine-wire copper conductor
- Star quad
- Overall screening with copper braid and plastic-laminated aluminium foil
- Outer sheath made of PVC
- Colour: green (based on RAL 6018)
- Pre-assembled patchcord with a M12 D-coded connector on both sides
- 4 pole M12 connector with vibration protection

### Technical data

	<b>Minimum bending radius</b> Flexing: 15 x outer diameter Fixed installation: 10 x outer diameter
	<b>Protection rating</b> IP 67 / IP 69K
	<b>Characteristic impedance</b> 100 Ohm +/- 15%
	<b>Temperature range</b> Flexing: -20°C to +60°C Fixed installation: -40°C to +80°C

Article number	Article designation	Number of pairs and AWG per conductor	Length (m)	Copper index (kg/km)
<b>Angled connector on straight connector</b>				
2171037	IE-PNB-5-M12D-A-1-Y-2-22-7-M12D-S	2x2xAWG22	1.0	31.3
2171038	IE-PNB-5-M12D-A-2-Y-2-22-7-M12D-S	2x2xAWG22	2.0	62.6
2171039	IE-PNB-5-M12D-A-3-Y-2-22-7-M12D-S	2x2xAWG22	3.0	93.9
2171040	IE-PNB-5-M12D-A-5-Y-2-22-7-M12D-S	2x2xAWG22	5.0	156.5
2171041	IE-PNB-5-M12D-A-10-Y-2-22-7-M12D-S	2x2xAWG22	10.0	313.0
2171042	IE-PNB-5-M12D-A-20-Y-2-22-7-M12D-S	2x2xAWG22	20.0	626.0
<b>Straight connector on straight connector</b>				
2171025	IE-PNB-5-M12D-S-1-Y-2-22-7-M12D-S	2x2xAWG22	1.0	31.3
2171026	IE-PNB-5-M12D-S-2-Y-2-22-7-M12D-S	2x2xAWG22	2.0	62.6
2171027	IE-PNB-5-M12D-S-3-Y-2-22-7-M12D-S	2x2xAWG22	3.0	93.9
2171028	IE-PNB-5-M12D-S-5-Y-2-22-7-M12D-S	2x2xAWG22	5.0	156.5
2171029	IE-PNB-5-M12D-S-10-Y-2-22-7-M12D-S	2x2xAWG22	10.0	313.0
2171030	IE-PNB-5-M12D-S-20-Y-2-22-7-M12D-S	2x2xAWG22	20.0	626.0

Unless specified otherwise, the shown product values are nominal values. Detailed values (e.g. tolerances) are available upon request.  
Copper price basis: EUR 150/100kg. Refer to catalogue appendix T17 for the definition and calculation of copper-related surcharges.  
Other lengths and types of connectors are available upon request.  
Photographs are not to scale and do not represent detailed images of the respective products.



## Industrial Ethernet PN B Patchcord M12 on free conductor end



**Info**

- For PROFINET applications (D-coded)

**Benefits**

- Non-permanent connections allow for easy change of equipment
- For directly connecting two electric components
- CAT.5-Performance
- Suitable for direct connector assembly

**Application range**

- For PROFINET applications type B
- Flexible use
- Suitable for EtherCAT and EtherNet/IP applications
- Suitable for use in industrial applications
- For indoor use

**Product features**

- CAT.5-Performance
- Meets the requirements according to CAT.5e, ISO/IEC 11801 and EN 50173, Class D
- 2pair: 10 / 100 Mbit/s for Industrial Ethernet

**Norm references / Approvals**

- The cable is UL/CSA-approved (CMG)
- UL File Number: E249137

**Design**

- Fine-wire, tinned-copper conductor
- Star quad
- Overall screening with copper braid and plastic-laminated aluminium foil
- Outer sheath made of PVC
- Colour: green (based on RAL 6018)
- Pre-assembled patchcord with a M12 connector on free conductor end
- 4 pole M12 connector with vibration protection

**Technical data**



**Minimum bending radius**

Flexing: 15 x outer diameter  
Fixed installation: 10 x outer diameter



**Protection rating**

IP 67 / IP 69K



**Characteristic impedance**

100 Ohm +/- 15%



**Temperature range**

Flexing: -20°C to +60°C  
Fixed installation: -40°C to +80°C

Article number	Article designation	Number of pairs and AWG per conductor	Length (m)	Copper index (kg/km)
<b>Angled connector on free conductor end</b>				
2171043	IE-PNB-5-M12D-A-1-Y-2-22-7-OE	2x2xAWG22	1.0	31.3
2171044	IE-PNB-5-M12D-A-2-Y-2-22-7-OE	2x2xAWG22	2.0	62.6
2171045	IE-PNB-5-M12D-A-3-Y-2-22-7-OE	2x2xAWG22	3.0	93.9
2171046	IE-PNB-5-M12D-A-5-Y-2-22-7-OE	2x2xAWG22	5.0	156.5
2171047	IE-PNB-5-M12D-A-10-Y-2-22-7-OE	2x2xAWG22	10.0	313.0
2171048	IE-PNB-5-M12D-A-20-Y-2-22-7-OE	2x2xAWG22	20.0	626.0
<b>straight connector on free conductor end</b>				
2171031	IE-PNB-5-M12D-S-1-Y-2-22-7-OE	2x2xAWG22	1.0	31.3
2171032	IE-PNB-5-M12D-S-2-Y-2-22-7-OE	2x2xAWG22	2.0	62.6
2171033	IE-PNB-5-M12D-S-3-Y-2-22-7-OE	2x2xAWG22	3.0	93.9
2171034	IE-PNB-5-M12D-S-5-Y-2-22-7-OE	2x2xAWG22	5.0	156.5
2171035	IE-PNB-5-M12D-S-10-Y-2-22-7-OE	2x2xAWG22	10.0	313.0
2171036	IE-PNB-5-M12D-S-20-Y-2-22-7-OE	2x2xAWG22	20.0	626.0

Unless specified otherwise, the shown product values are nominal values. Detailed values (e.g. tolerances) are available upon request.  
Copper price basis: EUR 150/100kg. Refer to catalogue appendix T17 for the definition and calculation of copper-related surcharges.  
Other lengths and types of connectors are available upon request.  
Photographs are not to scale and do not represent detailed images of the respective products.

**Accessories**

- Connector RJ45 Cat.5e for Profinet refer to page 196
- Connector RJ45 angled Cat.5e for Profinet refer to page 196
- BUS M12 connectors that can be assembled



## Industrial Ethernet PN C patchcord M12

**Info**

- For PROFINET applications (D-coded)



### Benefits

- For directly connecting two electric components
- Non-permanent connections allow for easy change of equipment
- CAT.5-Performance

### Application range

- For PROFINET applications type C
- Highly flexible application
- Suitable for EtherCAT and EtherNet/IP applications
- Suitable for use in industrial applications
- For indoor use

### Product features

- CAT.5-Performance
- Meets the requirements according to CAT.5e, ISO/IEC 11801 and EN 50173, Class D
- 2pair: 10/100 Mbit/s for Industrial Ethernet

### Norm references / Approvals

- The cable is UL/CSA-approved (CMX)

### Design

- Extra-fine wire, tinned braided conductor
- Star quad
- Overall screening with copper braid and plastic-laminated aluminium foil
- Outer sheath made of PUR
- Colour: green (based on RAL 6018)
- Pre-assembled patchcord with a M12 D-coded connector on both sides
- 4 pole M12 connector with vibration protection

### Technical data

- Minimum bending radius**  
Flexing: 8 x outer diameter
- Protection rating**  
IP 67 / IP 69K
- Characteristic impedance**  
100 Ohm +/- 15%
- Temperature range**  
Flexing: -20°C to +60°C  
Fixed installation: -30°C to +70°C

Article number	Article designation	Number of pairs and AWG per conductor	Length (m)	Copper index (kg/km)
<b>Angled connector on straight connector</b>				
2171061	IE-PNC-5-M12D-A-1-P-2-22-FD-M12D-S	2x2xAWG22	1.0	31.3
2171062	IE-PNC-5-M12D-A-2-P-2-22-FD-M12D-S	2x2xAWG22	2.0	62.6
2171063	IE-PNC-5-M12D-A-3-P-2-22-FD-M12D-S	2x2xAWG22	3.0	93.9
2171064	IE-PNC-5-M12D-A-5-P-2-22-FD-M12D-S	2x2xAWG22	5.0	156.5
2171065	IE-PNC-5-M12D-A-10-P-2-22-FD-M12D-S	2x2xAWG22	10.0	313.0
2171066	IE-PNC-5-M12D-A-20-P-2-22-FD-M12D-S	2x2xAWG22	20.0	626.0
<b>Straight connector on straight connector</b>				
2171049	IE-PNC-5-M12D-S-1-P-2-22-FD-M12D-S	2x2xAWG22	1.0	31.3
2171050	IE-PNC-5-M12D-S-2-P-2-22-FD-M12D-S	2x2xAWG22	2.0	62.6
2171051	IE-PNC-5-M12D-S-3-P-2-22-FD-M12D-S	2x2xAWG22	3.0	93.9
2171052	IE-PNC-5-M12D-S-5-P-2-22-FD-M12D-S	2x2xAWG22	5.0	156.5
2171053	IE-PNC-5-M12D-S-10-P-2-22-FD-M12D-S	2x2xAWG22	10.0	313.0
2171054	IE-PNC-5-M12D-S-20-P-2-22-FD-M12D-S	2x2xAWG22	20.0	626.0

Unless specified otherwise, the shown product values are nominal values. Detailed values (e.g. tolerances) are available upon request. Copper price basis: EUR 150/100kg. Refer to catalogue appendix T17 for the definition and calculation of copper-related surcharges. Other lengths and types of connectors are available upon request. Photographs are not to scale and do not represent detailed images of the respective products.



## Industrial Ethernet PN C Patchcord M12 on free conductor end



**Info**

- For PROFINET applications (D-coded)

### Benefits

- Non-permanent connections allow for easy change of equipment
- For directly connecting two electric components
- CAT.5-Performance
- Suitable for direct connector assembly

### Application range

- For PROFINET applications type C
- Highly flexible application
- Suitable for EtherCAT and EtherNet/IP applications
- Suitable for use in industrial applications
- For indoor use

### Product features

- CAT.5-Performance
- Meets the requirements according to CAT.5e, ISO/IEC 11801 and EN 50173, Class D
- 2pair: 10/100 Mbit/s for Industrial Ethernet

### Norm references / Approvals

- The cable is UL/CSA-approved (CMX)
- UL File Number: E249137

### Design

- Extra-fine wire, tinned copper strands
- Star quad
- Overall screening with copper braid and plastic-laminated aluminium foil
- Outer sheath made of PUR
- Colour: green (based on RAL 6018)
- Pre-assembled patchcord with a M12 connector on free conductor end
- 4 pole M12 connector with vibration protection

### Technical data

- Minimum bending radius**  
Flexing: 8 x outer diameter
- Protection rating**  
IP 67 / IP 69K
- Characteristic impedance**  
100 Ohm +/- 15%
- Temperature range**  
Flexing: -20°C to +60°C  
Fixed installation: -30°C to +70°C

Article number	Article designation	Number of pairs and AWG per conductor	Length (m)	Copper index (kg/km)
<b>straight connector on free conductor end</b>				
2171055	IE-PNC-5-M12D-S-1-P-2-22-FD-OE	2x2xAWG22	1.0	31.3
2171056	IE-PNC-5-M12D-S-2-P-2-22-FD-OE	2x2xAWG22	2.0	62.6
2171057	IE-PNC-5-M12D-S-3-P-2-22-FD-OE	2x2xAWG22	3.0	93.9
2171058	IE-PNC-5-M12D-S-5-P-2-22-FD-OE	2x2xAWG22	5.0	156.5
2171059	IE-PNC-5-M12D-S-10-P-2-22-FD-OE	2x2xAWG22	10.0	313.0
2171060	IE-PNC-5-M12D-S-20-P-2-22-FD-OE	2x2xAWG22	20.0	626.0
<b>Angled connector on free conductor end</b>				
2171067	IE-PNC-5-M12D-A-1-P-2-22-FD-OE	2x2xAWG22	1.0	31.3
2171068	IE-PNC-5-M12D-A-2-P-2-22-FD-OE	2x2xAWG22	2.0	62.6
2171069	IE-PNC-5-M12D-A-3-P-2-22-FD-OE	2x2xAWG22	3.0	93.9
2171070	IE-PNC-5-M12D-A-5-P-2-22-FD-OE	2x2xAWG22	5.0	156.5
2171071	IE-PNC-5-M12D-A-10-P-2-22-FD-OE	2x2xAWG22	10.0	313.0
2171072	IE-PNC-5-M12D-A-20-P-2-22-FD-OE	2x2xAWG22	20.0	626.0

Unless specified otherwise, the shown product values are nominal values. Detailed values (e.g. tolerances) are available upon request.  
 Copper price basis: EUR 150/100kg. Refer to catalogue appendix T17 for the definition and calculation of copper-related surcharges.  
 Other lengths and types of connectors are available upon request.  
 Photographs are not to scale and do not represent detailed images of the respective products.

### Accessories

- Connector RJ45 Cat.5e for Profinet refer to page 196
- Connector RJ45 angled Cat.5e for Profinet refer to page 196
- BUS M12 connectors that can be assembled





New

## Industrial Ethernet patchcord P M12-M12



Info

● Industrial Ethernet cable

### Benefits

- Non-permanent connections allow for easy change of equipment
- For directly connecting two electric components
- CAT.5-Performance

### Application range

- Suitable for EtherCAT and EtherNet/IP applications
- Suitable for use in industrial applications
- For indoor use
- For flexible applications (7-wire stranded conductor)
- Automation technology





### Product features

- Meets the requirements according to CAT.5e, ISO/IEC 11801 and EN 50173, Class D
- 2pair: 10/100 Mbit/s for Industrial Ethernet

### Design

- Flexible fine-wire copper conductor
- Twisted pair construction permits largely interference-free operation (decoupling).
- Overall screening with copper braid and plastic-laminated aluminium foil
- Outer sheath made of PUR
- Colour: water blue (RAL 5021)
- Pre-assembled patchcord with a M12 D-coded connector on both sides
- 4 pole M12 connector with vibration protection

### Technical data

-  **Minimum bending radius**  
Flexing: 15 x outer diameter  
Fixed installation: 8 x outer diameter
-  **Protection rating**  
IP 67 / IP 69K
-  **Characteristic impedance**  
100 Ohm +/- 15%
-  **Temperature range**  
Flexing: -5°C to +50°C (UL: +80°C)  
Fixed installation: -30°C to +80°C

Article number	Article designation	Number of pairs and AWG per conductor	Length (m)	Copper index (kg/km)
<b>Industrial Ethernet patchcord P M12-M12</b>				
2171097	IE-5-M12D-S-1-P-2-26-7-M12D-S	2x2xAWG26	1.0	19.0
2171098	IE-5-M12D-S-2-P-2-26-7-M12D-S	2x2xAWG26	2.0	38.0
2171099	IE-5-M12D-S-3-P-2-26-7-M12D-S	2x2xAWG26	3.0	57.0
2171100	IE-5-M12D-S-5-P-2-26-7-M12D-S	2x2xAWG26	5.0	95.0
2171101	IE-5-M12D-S-10-P-2-26-7-M12D-S	2x2xAWG26	10.0	190.0
2171102	IE-5-M12D-S-20-P-2-26-7-M12D-S	2x2xAWG26	20.0	380.0

Unless specified otherwise, the shown product values are nominal values. Detailed values (e.g. tolerances) are available upon request.  
Copper price basis: EUR 150/100kg. Refer to catalogue appendix T17 for the definition and calculation of copper-related surcharges.  
Other lengths and types of connectors are available upon request.  
Photographs are not to scale and do not represent detailed images of the respective products.



## Industrial Ethernet Patchcord P M12 on free conductor end



Info

- Industrial Ethernet cable

### Benefits

- Non-permanent connections allow for easy change of equipment
- For directly connecting two electric components
- CAT.5-Performance
- Suitable for direct connector assembly

### Application range

- Suitable for EtherCAT and EtherNet/IP applications
- Suitable for use in industrial applications
- For indoor use
- For flexible applications (7-wire stranded conductor)
- Automation technology

### Product features

- Meets the requirements according to CAT.5e, ISO/IEC 11801 and EN 50173, Class D
- 2pair: 10/100 Mbit/s for Industrial Ethernet

### Design

- Flexible fine-wire copper conductor
- Twisted pair construction permits largely interference-free operation (decoupling).
- Overall screening with copper braid and plastic-laminated aluminium foil
- Outer sheath made of PUR
- Colour: water blue (RAL 5021)
- Pre-assembled patchcord with a M12 connector on free conductor end
- 4 pole M12 connector with vibration protection

### Technical data



#### Minimum bending radius

Flexing: 15 x outer diameter  
Fixed installation: 8 x outer diameter



#### Protection rating

IP 67 / IP 69K



#### Characteristic impedance

100 Ohm +/- 15%



#### Temperature range

Flexing: -5°C to +50°C (UL: +80°C)  
Fixed installation: -30°C to +80°C

Article number	Article designation	Number of pairs and AWG per conductor	Length (m)	Copper index (kg/km)
<b>Industrial Ethernet Patchcord P M12 on free conductor end</b>				
2171103	IE-5-M12D-S-1-P-2-26-7-OE	2x2xAWG26	1.0	19.0
2171104	IE-5-M12D-S-2-P-2-26-7-OE	2x2xAWG26	2.0	38.0
2171105	IE-5-M12D-S-3-P-2-26-7-OE	2x2xAWG26	3.0	57.0
2171106	IE-5-M12D-S-5-P-2-26-7-OE	2x2xAWG26	5.0	95.0
2171107	IE-5-M12D-S-10-P-2-26-7-OE	2x2xAWG26	10.0	190.0
2171108	IE-5-M12D-S-20-P-2-26-7-OE	2x2xAWG26	20.0	380.0

Unless specified otherwise, the shown product values are nominal values. Detailed values (e.g. tolerances) are available upon request.

Copper price basis: EUR 150/100kg. Refer to catalogue appendix T17 for the definition and calculation of copper-related surcharges.

Other lengths and types of connectors are available upon request.

Photographs are not to scale and do not represent detailed images of the respective products.

### Accessories

- Field mountable S/A connectors M8 refer to page 114
- Field-Terminable Connector RJ45 CAT.5e FM45 refer to page 195
- Connector RJ45 Cat.5e for Profinet refer to page 196
- Connector RJ45 angled Cat.5e for Profinet refer to page 196
- BUS M12 connectors that can be assembled



**Info**

- Industrial Ethernet cable

**Benefits**

- Non-permanent connections allow for easy change of equipment
- For directly connecting two electric components
- CAT.5-Performance

**Application range**

- Suitable for EtherCAT and EtherNet/IP applications
- Suitable for use in industrial applications
- For indoor use
- For flexible applications (7-wire stranded conductor)
- Automation technology

**Product features**

- Meets the requirements according to CAT.5e, ISO/IEC 11801 and EN 50173, Class D
- 2pair: 10/ 100 Mbit/s for Industrial Ethernet

**Design**

- Flexible fine-wire copper conductor
- Twisted pair construction permits largely interference-free operation (decoupling).
- Overall screening with copper braid and plastic-laminated aluminium foil
- Outer sheath made of PUR
- Colour: water blue (RAL 5021)
- Pre-assembled connection cable with M12 connector, "D" coded and RJ45-connector
- 4 pole M12 connector with vibration protection

**Technical data**

- Minimum bending radius**  
Flexing: 15 x outer diameter  
Fixed installation: 8 x outer diameter
- Protection rating**  
M12 - IP 67 / IP 69K  
RJ45 - IP 20
- Characteristic impedance**  
100 Ohm +/- 15%
- Temperature range**  
Flexing: -5°C to +50°C (UL: +80°C)  
Fixed installation: -30°C to +80°C

Article number	Article designation	Number of pairs and AWG per conductor	Length (m)	Copper index (kg/km)
<b>Industrial Ethernet Patchcord M12-RJ45 P</b>				
2171109	IE-5-M12D-S-1-P-2-26-7-RJ45	2x2XAWG26	1.0	19.0
2171110	IE-5-M12D-S-2-P-2-26-7-RJ45	2x2XAWG26	2.0	38.0
2171111	IE-5-M12D-S-3-P-2-26-7-RJ45	2x2XAWG26	3.0	57.0
2171112	IE-5-M12D-S-5-P-2-26-7-RJ45	2x2XAWG26	5.0	95.0
2171113	IE-5-M12D-S-10-P-2-26-7-RJ45	2x2XAWG26	10.0	190.0
2171114	IE-5-M12D-S-20-P-2-26-7-RJ45	2x2XAWG26	20.0	380.0

Unless specified otherwise, the shown product values are nominal values. Detailed values (e.g. tolerances) are available upon request.  
Copper price basis: EUR 150/100kg. Refer to catalogue appendix T17 for the definition and calculation of copper-related surcharges.  
Other lengths and types of connectors are available upon request.  
Photographs are not to scale and do not represent detailed images of the respective products.



**Info**

- Industrial Ethernet cable

**Benefits**

- Non-permanent connections allow for easy change of equipment
- For directly connecting two electric components
- CAT.5-Performance

**Application range**

- Suitable for EtherCAT and EtherNet/IP applications
- Suitable for use in industrial applications
- For indoor use
- For flexible applications (7-wire stranded conductor)
- Automation technology

**Product features**

- Meets the requirements according to CAT.5e, ISO/IEC 11801 and EN 50173, Class D
- 2pair: 10/ 100 Mbit/s for Industrial Ethernet
- 4pair: 10/ 100/ 1000 Mbit/s for Industrial Ethernet

**Design**

- Flexible fine-wire copper conductor
- Twisted pair construction permits largely interference-free operation (decoupling).
- Overall screening with copper braid and plastic-laminated aluminium foil
- Outer sheath made of PUR

**Technical data**

- Minimum bending radius**  
Flexing: 15 x outer diameter  
Fixed installation: 8 x outer diameter
- Protection rating**  
IP 20
- Characteristic impedance**  
100 Ohm +/- 15%
- Temperature range**  
Flexing: -5°C to +50°C (UL: +80°C)  
Fixed installation: -30°C to +80°C

- Colour: water blue (RAL 5021)
- Pre-assembled patchcord with a RJ45 connector on both sides

Article number	Article designation	Number of pairs and AWG per conductor	Length (m)	Copper index (kg/km)
<b>2-pair version</b>				
2171115	IE-5-RJ45-1-P-2-26-7-RJ45	2x2xAWG26	1.0	19.0
2171116	IE-5-RJ45-2-P-2-26-7-RJ45	2x2xAWG26	2.0	38.0
2171117	IE-5-RJ45-3-P-2-26-7-RJ45	2x2xAWG26	3.0	57.0
2171118	IE-5-RJ45-5-P-2-26-7-RJ45	2x2xAWG26	5.0	95.0
2171119	IE-5-RJ45-10-P-2-26-7-RJ45	2x2xAWG26	10.0	190.0
2171120	IE-5-RJ45-20-P-2-26-7-RJ45	2x2xAWG26	20.0	380.0
<b>4-pair version</b>				
2171501	IE-5-RJ45-1-P-4-26-7-RJ45	4x2xAWG26	1.0	25.0
2171502	IE-5-RJ45-2-P-4-26-7-RJ45	4x2xAWG26	2.0	50.0
2171503	IE-5-RJ45-3-P-4-26-7-RJ45	4x2xAWG26	3.0	75.0
2171504	IE-5-RJ45-5-P-4-26-7-RJ45	4x2xAWG26	5.0	125.0
2171505	IE-5-RJ45-10-P-4-26-7-RJ45	4x2xAWG26	10.0	250.0
2171506	IE-5-RJ45-20-P-4-26-7-RJ45	4x2xAWG26	20.0	500.0

Unless specified otherwise, the shown product values are nominal values. Detailed values (e.g. tolerances) are available upon request.  
Copper price basis: EUR 150/100kg. Refer to catalogue appendix T17 for the definition and calculation of copper-related surcharges.  
Other lengths and types of connectors are available upon request.  
Photographs are not to scale and do not represent detailed images of the respective products.



## Industrial Ethernet Patchcord P RJ45 on free conductor end



### Benefits

- Non-permanent connections allow for easy change of equipment
- For directly connecting two electric components
- CAT.5-Performance
- Suitable for direct connector assembly

### Application range

- Suitable for EtherCAT and EtherNet/IP applications
- Suitable for use in industrial applications
- For indoor use
- For flexible applications (7-wire stranded conductor)
- Automation technology

### Product features

- Meets the requirements according to CAT.5e, ISO/IEC 11801 and EN 50173, Class D
- 2pair: 10/100 Mbit/s for Industrial Ethernet
- 4pair: 10/100/1000 Mbit/s for Industrial Ethernet

### Design

- Flexible fine-wire copper conductor
- Twisted pair construction permits largely interference-free operation (decoupling).
- Overall screening with copper braid and plastic-laminated aluminium foil
- Outer sheath made of PUR
- Colour: water blue (RAL 5021)

**Info**

- Industrial Ethernet cable

**Technical data**

- Minimum bending radius**  
Flexing: 15 x outer diameter  
Fixed installation: 8 x outer diameter
- Protection rating**  
IP 20
- Characteristic impedance**  
100 Ohm +/- 15%
- Temperature range**  
Flexing: -5°C to +50°C (UL: +80°C)  
Fixed installation: -30°C to +80°C

- Pre-assembled patchcord with a RJ45 connector on free conductor end

Article number	Article designation	Number of pairs and AWG per conductor	Length (m)	Copper index (kg/km)
<b>Industrial Ethernet Patchcord P RJ45 on free conductor end</b>				
2171507	IE-5-RJ45-1-P-4-26-7-OE	4x2xAWG26	1.0	25.0
2171508	IE-5-RJ45-2-P-4-26-7-OE	4x2xAWG26	2.0	50.0
2171509	IE-5-RJ45-3-P-4-26-7-OE	4x2xAWG26	3.0	75.0
2171510	IE-5-RJ45-5-P-4-26-7-OE	4x2xAWG26	5.0	125.0
2171511	IE-5-RJ45-10-P-4-26-7-OE	4x2xAWG26	10.0	250.0
2171512	IE-5-RJ45-20-P-4-26-7-OE	4x2xAWG26	20.0	500.0

Unless specified otherwise, the shown product values are nominal values. Detailed values (e.g. tolerances) are available upon request. Copper price basis: EUR 150/100kg. Refer to catalogue appendix T17 for the definition and calculation of copper-related surcharges. Other lengths and types of connectors are available upon request. Photographs are not to scale and do not represent detailed images of the respective products.

### Accessories

- Field-Terminable Connector RJ45 CAT.5e FM45 refer to page 195
- Connector RJ45 Cat.6<sub>A</sub> fieldmountable refer to page 197
- Connector RJ45 angled Cat.6<sub>A</sub> fieldmountable refer to page 197
- Connector M12 x-coded Cat.6<sub>A</sub> 10G fieldmountable refer to page 198
- EPIC® DATA CCR FA refer to page 199



## Industrial Ethernet Patchcord H M12-M12



### Benefits

- Non-permanent connections allow for easy change of equipment
- For directly connecting two electric components
- CAT.5-Performance

### Application range

- Suitable for EtherCAT and EtherNet/IP applications
- Suitable for use in industrial applications
- For indoor use
- For flexible applications (7-wire stranded conductor)
- Automation technology

### Product features

- Meets the requirements according to CAT.5e, ISO/IEC 11801 and EN 50173, Class D
- 2pair: 10/100 Mbit/s for Industrial Ethernet

### Design

- Flexible fine-wire copper conductor
- Twisted pair construction permits largely interference-free operation (decoupling).
- Overall screening with copper braid and plastic-laminated aluminium foil
- Outer sheath: halogen-free, flame-retardant compound
- Colour: water blue (RAL 5021)

**Info**

- Industrial Ethernet cable

**Technical data**

- Minimum bending radius**  
Flexing: 15 x outer diameter  
Fixed installation: 6 x cable diameter
- Protection rating**  
IP 67 / IP 69K
- Characteristic impedance**  
100 Ohm +/- 15%
- Temperature range**  
During installation: -5°C to +60°C  
Fixed installation: -30°C to +80°C

- Pre-assembled patchcord with a M12 D-coded connector on both sides
- 4 pole M12 connector with vibration protection

Article number	Article designation	Number of pairs and AWG per conductor	Length (m)	Copper index (kg/km)
<b>Industrial Ethernet Patchcord H M12-M12</b>				
2171073	IE-5-M12D-S-1-H-2-26-7-M12D-S	2x2xAWG26	1.0	19.0
2171074	IE-5-M12D-S-2-H-2-26-7-M12D-S	2x2xAWG26	2.0	38.0
2171075	IE-5-M12D-S-3-H-2-26-7-M12D-S	2x2xAWG26	3.0	57.0
2171076	IE-5-M12D-S-5-H-2-26-7-M12D-S	2x2xAWG26	5.0	95.0
2171077	IE-5-M12D-S-10-H-2-26-7-M12D-S	2x2xAWG26	10.0	190.0
2171078	IE-5-M12D-S-20-H-2-26-7-M12D-S	2x2xAWG26	20.0	380.0

Unless specified otherwise, the shown product values are nominal values. Detailed values (e.g. tolerances) are available upon request. Copper price basis: EUR 150/100kg. Refer to catalogue appendix T17 for the definition and calculation of copper-related surcharges. Other lengths and types of connectors are available upon request. Photographs are not to scale and do not represent detailed images of the respective products.



## Industrial Ethernet Patchcord H M12 on free conductor end

**Info**

- Industrial Ethernet cable



### Benefits

- Non-permanent connections allow for easy change of equipment
- For directly connecting two electric components
- CAT.5-Performance
- Suitable for direct connector assembly

### Application range

- Suitable for EtherCAT and EtherNet/IP applications
- Suitable for use in industrial applications
- For indoor use
- For flexible applications (7-wire stranded conductor)
- Automation technology

### Product features

- Meets the requirements according to CAT.5e, ISO/IEC 11801 and EN 50173, Class D
- 2pair: 10/100 Mbit/s for Industrial Ethernet

### Design

- Flexible fine-wire copper conductor
- Twisted pair construction permits largely interference-free operation (decoupling).
- Overall screening with copper braid and plastic-laminated aluminium foil
- Outer sheath: halogen-free, flame-retardant compound
- Colour: water blue (RAL 5021)
- Pre-assembled patchcord with a M12 connector on free conductor end
- 4 pole M12 connector with vibration protection

### Technical data

- Minimum bending radius**  
Flexing: 15 x outer diameter  
Fixed installation: 6 x cable diameter
- Protection rating**  
IP 67 / IP 69K
- Characteristic impedance**  
100 Ohm +/- 15%
- Temperature range**  
During installation: -5 °C to +60 °C  
Fixed installation: -30 °C to +80 °C

Article number	Article designation	Number of pairs and AWG per conductor	Length (m)	Copper index (kg/km)
<b>Industrial Ethernet Patchcord H M12 on free conductor end</b>				
2171079	IE-5-M12D-S-1-H-2-26-7-OE	2x2xAWG26	1.0	19.0
2171080	IE-5-M12D-S-2-H-2-26-7-OE	2x2xAWG26	2.0	38.0
2171081	IE-5-M12D-S-3-H-2-26-7-OE	2x2xAWG26	3.0	57.0
2171082	IE-5-M12D-S-5-H-2-26-7-OE	2x2xAWG26	5.0	95.0
2171083	IE-5-M12D-S-10-H-2-26-7-OE	2x2xAWG26	10.0	190.0
2171084	IE-5-M12D-S-20-H-2-26-7-OE	2x2xAWG26	20.0	380.0

Unless specified otherwise, the shown product values are nominal values. Detailed values (e.g. tolerances) are available upon request.  
Copper price basis: EUR 150/100kg. Refer to catalogue appendix T17 for the definition and calculation of copper-related surcharges.  
Other lengths and types of connectors are available upon request.  
Photographs are not to scale and do not represent detailed images of the respective products.

### Accessories

- Field mountable S/A connectors M8 refer to page 114
- Connector RJ45 Cat.5e for Profinet refer to page 196
- Connector RJ45 angled Cat.5e for Profinet refer to page 196
- BUS M12 connectors that can be assembled
- Connector RJ45 Cat.6<sub>A</sub> FM for FD-cables





## Industrial Ethernet patchcord H M12-RJ45



**Info**

- Industrial Ethernet cable

### Benefits

- Non-permanent connections allow for easy change of equipment
- For directly connecting two electric components
- CAT.5-Performance

### Application range

- Suitable for EtherCAT and EtherNet/IP applications
- Suitable for use in industrial applications
- For indoor use
- For flexible applications (7-wire stranded conductor)
- Automation technology

### Product features

- Meets the requirements according to CAT.5e, ISO/IEC 11801 and EN 50173, Class D
- 2pair: 10/100 Mbit/s for Industrial Ethernet

### Design

- Flexible fine-wire copper conductor
- Twisted pair construction permits largely interference-free operation (decoupling).
- Overall screening with copper braid and plastic-laminated aluminium foil
- Outer sheath: halogen-free, flame-retardant compound
- Colour: water blue (RAL 5021)
- Pre-assembled connection cable with M12 connector, "D" coded and RJ45-connector
- 4 pole M12 connector with vibration protection

### Technical data

- Minimum bending radius**  
Flexing: 15 x outer diameter  
Fixed installation: 6 x outer diameter
- Protection rating**  
M12 - IP 67 / IP 69K  
RJ45 - IP 20
- Characteristic impedance**  
100 Ohm +/- 15%
- Temperature range**  
During installation: -5 °C to +60 °C  
Fixed installation: -30°C to +80°C

Article number	Article designation	Number of pairs and AWG per conductor	Length (m)	Copper index (kg/km)
<b>Industrial Ethernet patchcord H M12-RJ45</b>				
2171085	IE-5-M12D-S-1-H-2-26-7-RJ45	2x2xAWG26	1.0	19.0
2171086	IE-5-M12D-S-2-H-2-26-7-RJ45	2x2xAWG26	2.0	38.0
2171087	IE-5-M12D-S-3-H-2-26-7-RJ45	2x2xAWG26	3.0	57.0
2171088	IE-5-M12D-S-5-H-2-26-7-RJ45	2x2xAWG26	5.0	95.0
2171089	IE-5-M12D-S-10-H-2-26-7-RJ45	2x2xAWG26	10.0	190.0
2171090	IE-5-M12D-S-20-H-2-26-7-RJ45	2x2xAWG26	20.0	380.0

Unless specified otherwise, the shown product values are nominal values. Detailed values (e.g. tolerances) are available upon request.  
Copper price basis: EUR 150/100kg. Refer to catalogue appendix T17 for the definition and calculation of copper-related surcharges.  
Other lengths and types of connectors are available upon request.  
Photographs are not to scale and do not represent detailed images of the respective products.



## Industrial Ethernet patchcord H RJ45-RJ45



**Info**

- Industrial Ethernet cable

### Benefits

- Non-permanent connections allow for easy change of equipment
- For directly connecting two electric components
- CAT.5-Performance

### Application range

- Suitable for EtherCAT and EtherNet/IP applications
- Automation technology
- For indoor use
- For flexible applications (7-wire stranded conductor)
- Automation technology

### Product features

- Meets the requirements according to CAT.5e, ISO/IEC 11801 and EN 50173, Class D
- 2pair: 10/100 Mbit/s for Industrial Ethernet
- 4pair: 10/100/1000 Mbit/s for Industrial Ethernet

### Design

- Flexible fine-wire copper conductor
- Twisted pair construction permits largely interference-free operation (decoupling).
- Overall screening with copper braid and plastic-laminated aluminium foil
- Outer sheath: halogen-free, flame-retardant compound
- Colour: water blue (RAL 5021)
- Pre-assembled patchcord with a RJ45 connector on both sides

### Technical data

- Minimum bending radius**  
Flexing: 15 x outer diameter  
Fixed installation: 6 x outer diameter
- Protection rating**  
IP 20
- Characteristic impedance**  
100 Ohm +/- 15%
- Temperature range**  
During installation: -5 °C to +60 °C  
Fixed installation: -30 °C to +80 °C

Article number	Article designation	Number of pairs and AWG per conductor	Length (m)	Copper index (kg/km)
<b>2-pair version</b>				
2171091	IE-5-RJ45-1-H-2-26-7-RJ45	2x2xAWG26	1.0	19.0
2171092	IE-5-RJ45-2-H-2-26-7-RJ45	2x2xAWG26	2.0	38.0
2171093	IE-5-RJ45-3-H-2-26-7-RJ45	2x2xAWG26	3.0	57.0
2171095	IE-5-RJ45-10-H-2-26-7-RJ45	2x2xAWG26	10.0	190.0
2171096	IE-5-RJ45-20-H-2-26-7-RJ45	2x2xAWG26	20.0	380.0
2171094	IE-5-RJ45-5-H-2-26-7-RJ45	2x2xAWG26	5.0	95.0
<b>4-pair version</b>				
2171513	IE-5-RJ45-1-H-4-26-7-RJ45	4x2xAWG26	1.0	25.0
2171514	IE-5-RJ45-2-H-4-26-7-RJ45	4x2xAWG26	2.0	50.0
2171515	IE-5-RJ45-3-H-4-26-7-RJ45	4x2xAWG26	3.0	75.0
2171516	IE-5-RJ45-5-H-4-26-7-RJ45	4x2xAWG26	5.0	125.0
2171517	IE-5-RJ45-10-H-4-26-7-RJ45	4x2xAWG26	10.0	250.0
2171518	IE-5-RJ45-20-H-4-26-7-RJ45	4x2xAWG26	20.0	500.0

Unless specified otherwise, the shown product values are nominal values. Detailed values (e.g. tolerances) are available upon request.  
Copper price basis: EUR 150/100kg. Refer to catalogue appendix T17 for the definition and calculation of copper-related surcharges.  
Other lengths and types of connectors are available upon request.  
Photographs are not to scale and do not represent detailed images of the respective products.



## Industrial Ethernet Patchcord H RJ45 on free conductor end



Info

- Industrial Ethernet cable

### Benefits

- Non-permanent connections allow for easy change of equipment
- For directly connecting two electric components
- CAT.5-Performance
- Suitable for direct connector assembly

### Application range

- Suitable for EtherCAT and EtherNet/IP applications
- Automation technology
- For indoor use
- For flexible applications (7-wire stranded conductor)
- Automation technology

### Product features

- Meets the requirements according to CAT.5e, ISO/IEC 11801 and EN 50173, Class D
- 2pair: 10/100 Mbit/s for Industrial Ethernet
- 4pair: 10/100/1000 Mbit/s for Industrial Ethernet

### Design

- Flexible fine-wire copper conductor
- Twisted pair construction permits largely interference-free operation (decoupling).
- Overall screening with copper braid and plastic-laminated aluminium foil
- Outer sheath: halogen-free, flame-retardant compound
- Colour: water blue (RAL 5021)
- Pre-assembled patchcord with a RJ45 connector on free conductor end

### Technical data

- Minimum bending radius**  
Flexing: 15 x outer diameter  
Fixed installation: 6 x outer diameter
- Protection rating**  
IP 20
- Characteristic impedance**  
100 Ohm +/- 15%
- Temperature range**  
During installation: -5 °C to +60 °C  
Fixed installation: -30°C to +80°C

Article number	Article designation	Number of pairs and AWG per conductor	Length (m)	Copper index (kg/km)
<b>Industrial Ethernet Patchcord H RJ45 on free conductor end</b>				
2171519	IE-5-RJ45-1-H-4-26-7-OE	4x2xAWG26	1.0	25.0
2171520	IE-5-RJ45-2-H-4-26-7-OE	4x2xAWG26	2.0	50.0
2171521	IE-5-RJ45-3-H-4-26-7-OE	4x2xAWG26	3.0	75.0
2171522	IE-5-RJ45-5-H-4-26-7-OE	4x2xAWG26	5.0	125.0
2171523	IE-5-RJ45-10-H-4-26-7-OE	4x2xAWG26	10.0	250.0
2171524	IE-5-RJ45-20-H-4-26-7-OE	4x2xAWG26	20.0	500.0

Unless specified otherwise, the shown product values are nominal values. Detailed values (e.g. tolerances) are available upon request.  
 Copper price basis: EUR 150/100kg. Refer to catalogue appendix T17 for the definition and calculation of copper-related surcharges.  
 Other lengths and types of connectors are available upon request.  
 Photographs are not to scale and do not represent detailed images of the respective products.

### Accessories

- Field-Terminable Connector RJ45 CAT.5e FM45 refer to page 195
- Easy Connect RJ45 Modul Cat.6<sub>A</sub> 10G refer to page 199
- Connector M12 x-coded Cat.6<sub>A</sub> 10G fieldmountable refer to page 198
- EPIC® DATA CCR FA refer to page 199



**New**

## Industrial Ethernet EC FD Patchcord M 12-M 12

**Info**

- Industrial Ethernet cable
- Suitable for drag chains



### Benefits

- Non-permanent connections allow for easy change of equipment
- For directly connecting two electric components
- CAT.5-Performance

### Application range

- Suitable for EtherCAT and EtherNet/IP applications
- Suitable for use in industrial applications
- For indoor use
- For highly flexible applications
- Automation technology

### Product features

- Meets the requirements according to CAT.5e, ISO/IEC 11801 and EN 50173, Class D
- 2pair: 10/ 100 Mbit/s for Industrial Ethernet

### Design

- AWG 26 (19-wire)
- Overall screening with copper braid and plastic-laminated aluminium foil
- Outer sheath made of PUR
- Colour: green (based on RAL 6018)
- Pre-assembled patchcord with a M 12 D-coded connector on both sides
- 4 pole M 12 connector with vibration protection

### Technical data

- Minimum bending radius**  
Flexing: 8 x outer diameter  
Fixed installation: 4 x outer diameter
- Protection rating**  
IP 67 / IP 69K
- Characteristic impedance**  
100 Ohm +/- 15%
- Temperature range**  
During installation: -30°C to +50°C  
Fixed installation: -40°C to +80°C

Article number	Article designation	Number of pairs and AWG per conductor	Length (m)	Copper index (kg/km)
<b>Straight connector on straight connector</b>				
2171778	IE-EC-5-M12D-S-0,5-P-2-26-FD-M12D-S	2x2xAWG26	0,5	10,0
2171779	IE-EC-5-M12D-S-1-P-2-26-FD-M12D-S	2x2xAWG26	1,0	20,0
2171780	IE-EC-5-M12D-S-2-P-2-26-FD-M12D-S	2x2xAWG26	2,0	40,0
2171781	IE-EC-5-M12D-S-3-P-2-26-FD-M12D-S	2x2xAWG26	3,0	60,0
2171782	IE-EC-5-M12D-S-5-P-2-26-FD-M12D-S	2x2xAWG26	5,0	100,0
2171783	IE-EC-5-M12D-S-10-P-2-26-FD-M12D-S	2x2xAWG26	10,0	200,0
2171784	IE-EC-5-M12D-S-20-P-2-26-FD-M12D-S	2x2xAWG26	20,0	400,0
<b>Angled connector on straight connector</b>				
2171785	IE-EC-5-M12D-A-0,5-P-2-26-FD-M12D-S	2x2xAWG26	0,5	10,0
2171786	IE-EC-5-M12D-A-1-P-2-26-FD-M12D-S	2x2xAWG26	1,0	20,0
2171787	IE-EC-5-M12D-A-2-P-2-26-FD-M12D-S	2x2xAWG26	2,0	40,0
2171788	IE-EC-5-M12D-A-3-P-2-26-FD-M12D-S	2x2xAWG26	3,0	60,0
2171789	IE-EC-5-M12D-A-5-P-2-26-FD-M12D-S	2x2xAWG26	5,0	100,0
2171790	IE-EC-5-M12D-A-10-P-2-26-FD-M12D-S	2x2xAWG26	2,0	200,0
2171791	IE-EC-5-M12D-A-20-P-2-26-FD-M12D-S	2x2xAWG26	20,0	400,0
<b>Angled connector on angled connector</b>				
2171906	IE-EC-5-M12D-A-0,5-P-2-26-FD-M12D-A	2x2xAWG26	0,5	10,0
2171907	IE-EC-5-M12D-A-1-P-2-26-FD-M12D-A	2x2xAWG26	1,0	20,0
2171908	IE-EC-5-M12D-A-2-P-2-26-FD-M12D-A	2x2xAWG26	2,0	40,0
2171909	IE-EC-5-M12D-A-3-P-2-26-FD-M12D-A	2x2xAWG26	3,0	60,0
2171910	IE-EC-5-M12D-A-5-P-2-26-FD-M12D-A	2x2xAWG26	5,0	100,0
2171911	IE-EC-5-M12D-A-10-P-2-26-FD-M12D-A	2x2xAWG26	10,0	200,0
2171913	IE-EC-5-M12D-A-20-P-2-26-FD-M12D-A	2x2xAWG26	20,0	400,0

Unless specified otherwise, the shown product values are nominal values. Detailed values (e.g. tolerances) are available upon request.  
Copper price basis: EUR 150/100kg. Refer to catalogue appendix T17 for the definition and calculation of copper-related surcharges.  
Other lengths and types of connectors are available upon request.  
Photographs are not to scale and do not represent detailed images of the respective products.



New

## Industrial Ethernet EC FD Patchcord M12 on free conductor end



Info

- Industrial Ethernet cable
- Suitable for drag chains

### Benefits

- Non-permanent connections allow for easy change of equipment
- For directly connecting two electric components
- CAT.5-Performance

### Application range

- Suitable for EtherCAT and EtherNet/IP applications
- Suitable for use in industrial applications
- For indoor use
- For highly flexible applications
- Automation technology

### Product features

- Meets the requirements according to CAT.5e, ISO/IEC 11801 and EN 50173, Class D
- 2pair: 10/100 Mbit/s for Industrial Ethernet

### Design

- AWG 26 (19-wire)
- Overall screening with copper braid and plastic-laminated aluminium foil
- Outer sheath made of PUR
- Colour: green (based on RAL 6018)
- Pre-assembled patchcord with a M12 connector on free conductor end
- 4 pole M12 connector with vibration protection

### Technical data



#### Minimum bending radius

Flexing: 8 x outer diameter  
Fixed installation: 4 x outer diameter



#### Protection rating

IP 67 / IP 69K



#### Characteristic impedance

100 Ohm +/- 15%



#### Temperature range

During installation: -30°C to +50°C  
Fixed installation: -40°C to +80°C

Article number	Article designation	Number of pairs and AWG per conductor	Length (m)	Copper index (kg/km)
<b>straight connector on free conductor end</b>				
2171792	IE-EC-5-M12D-S-0,5-P-2-26-FD-OE	2x2xAWG26	0.5	10.0
2171793	IE-EC-5-M12D-S-1-P-2-26-FD-OE	2x2xAWG26	1.0	20.0
2171794	IE-EC-5-M12D-S-2-P-2-26-FD-OE	2x2xAWG26	2.0	40.0
2171795	IE-EC-5-M12D-S-3-P-2-26-FD-OE	2x2xAWG26	3.0	60.0
2171796	IE-EC-5-M12D-S-5-P-2-26-FD-OE	2x2xAWG26	5.0	100.0
2171797	IE-EC-5-M12D-S-10-P-2-26-FD-OE	2x2xAWG26	10.0	200.0
2171798	IE-EC-5-M12D-S-20-P-2-26-FD-OE	2x2xAWG26	20.0	400.0
<b>Angled connector on free conductor end</b>				
2171870	IE-EC-5-M12D-A-0,5-P-2-26-FD-OE	2x2xAWG26	0.5	10.0
2171871	IE-EC-5-M12D-A-1-P-2-26-FD-OE	2x2xAWG26	1.0	20.0
2171872	IE-EC-5-M12D-A-2-P-2-26-FD-OE	2x2xAWG26	2.0	40.0
2171873	IE-EC-5-M12D-A-3-P-2-26-FD-OE	2x2xAWG26	3.0	60.0
2171874	IE-EC-5-M12D-A-5-P-2-26-FD-OE	2x2xAWG26	5.0	100.0
2171875	IE-EC-5-M12D-A-10-P-2-26-FD-OE	2x2xAWG26	10.0	200.0
2171876	IE-EC-5-M12D-A-20-P-2-26-FD-OE	2x2xAWG26	20.0	400.0

Unless specified otherwise, the shown product values are nominal values. Detailed values (e.g. tolerances) are available upon request.  
Copper price basis: EUR 150/100kg. Refer to catalogue appendix T17 for the definition and calculation of copper-related surcharges.  
Other lengths and types of connectors are available upon request.  
Photographs are not to scale and do not represent detailed images of the respective products.





New

## Industrial Ethernet EC FD Patchcord M12



**Info**

- Industrial Ethernet cable
- Suitable for drag chains

- Benefits**
- Non-permanent connections allow for easy change of equipment
  - For directly connecting two electric components
  - CAT.5-Performance

- Application range**
- Suitable for EtherCAT and EtherNet/IP applications
  - Suitable for use in industrial applications
  - For indoor use
  - For highly flexible applications
  - Automation technology

- Product features**
- Meets the requirements according to CAT.5e, ISO/IEC 11801 and EN 50173, Class D
  - 2pair: 10/ 100 Mbit/s for Industrial Ethernet

- Design**
- AWG 26 (19-wire)
  - Overall screening with copper braid and plastic-laminated aluminium foil
  - Outer sheath made of PUR
  - Colour: green (based on RAL 6018)
  - Pre-assembled connection cable with M12 connector, "D" coded and RJ45-connector
  - 4 pole M12 connector with vibration protection

**Technical data**

- Minimum bending radius**  
Flexing: 8 x outer diameter  
Fixed installation: 4 x outer diameter
- Protection rating**  
M12 - IP 67 / IP 69K  
RJ45 - IP 20
- Characteristic impedance**  
100 Ohm +/- 15%
- Temperature range**  
During installation: -30°C to +50°C  
Fixed installation: -40°C to +80°C

Article number	Article designation	Number of pairs and AWG per conductor	Length (m)	Copper index (kg/km)
<b>Industrial Ethernet EC FD Patchcord M12</b>				
2171750	IE-EC-5-M12D-S-0,5-P-2-26-FD-RJ45	2x2xAWG26	0,5	10,0
2171751	IE-EC-5-M12D-S-1-P-2-26-FD-RJ45	2x2xAWG26	1,0	20,0
2171752	IE-EC-5-M12D-S-2-P-2-26-FD-RJ45	2x2xAWG26	2,0	40,0
2171753	IE-EC-5-M12D-S-3-P-2-26-FD-RJ45	2x2xAWG26	3,0	60,0
2171754	IE-EC-5-M12D-S-5-P-2-26-FD-RJ45	2x2xAWG26	5,0	100,0
2171755	IE-EC-5-M12D-S-10-P-2-26-FD-RJ45	2x2xAWG26	10,0	200,0
2171756	IE-EC-5-M12D-S-20-P-2-26-FD-RJ45	2x2xAWG26	20,0	400,0

Unless specified otherwise, the shown product values are nominal values. Detailed values (e.g. tolerances) are available upon request.  
Copper price basis: EUR 150/100kg. Refer to catalogue appendix T17 for the definition and calculation of copper-related surcharges.  
Other lengths and types of connectors are available upon request.  
Photographs are not to scale and do not represent detailed images of the respective products.



New

## Industrial Ethernet EC FD Patchcord RJ45-RJ45



**Info**

- Industrial Ethernet cable
- Suitable for drag chains

- Benefits**
- Non-permanent connections allow for easy change of equipment
  - For directly connecting two electric components
  - CAT.5-Performance

- Application range**
- Suitable for EtherCAT and EtherNet/IP applications
  - Suitable for use in industrial applications
  - For indoor use
  - For highly flexible applications
  - Automation technology

- Product features**
- Meets the requirements according to CAT.5e, ISO/IEC 11801 and EN 50173, Class D
  - 2pair: 10/ 100 Mbit/s for Industrial Ethernet

- Design**
- AWG 26 (19-wire)
  - Overall screening with copper braid and plastic-laminated aluminium foil
  - Outer sheath made of PUR
  - Colour: green (based on RAL 6018)
  - Pre-assembled patchcord with a RJ45 connector on both sides

**Technical data**

- Minimum bending radius**  
Flexing: 8 x outer diameter  
Fixed installation: 4 x outer diameter
- Protection rating**  
IP 20
- Characteristic impedance**  
100 Ohm +/- 15%
- Temperature range**  
During installation: -30°C to +50°C  
Fixed installation: -40°C to +80°C

Article number	Article designation	Number of pairs and AWG per conductor	Length (m)	Copper index (kg/km)
<b>Industrial Ethernet EC FD Patchcord RJ45-RJ45</b>				
2171764	IE-EC-5-RJ45-0,5-P-2-26-FD-RJ45	2x2xAWG26	0,5	10,0
2171765	IE-EC-5-RJ45-1-P-2-26-FD-RJ45	2x2xAWG26	1,0	20,0
2171769	IE-EC-5-RJ45-10-P-2-26-FD-RJ45	2x2xAWG26	10,0	200,0
2171766	IE-EC-5-RJ45-2-P-2-26-FD-RJ45	2x2xAWG26	2,0	40,0
2171770	IE-EC-5-RJ45-20-P-2-26-FD-RJ45	2x2xAWG26	20,0	400,0
2171767	IE-EC-5-RJ45-3-P-2-26-FD-RJ45	2x2xAWG26	3,0	60,0
2171768	IE-EC-5-RJ45-5-P-2-26-FD-RJ45	2x2xAWG26	5,0	100,0

Unless specified otherwise, the shown product values are nominal values. Detailed values (e.g. tolerances) are available upon request.  
Copper price basis: EUR 150/100kg. Refer to catalogue appendix T17 for the definition and calculation of copper-related surcharges.  
Other lengths and types of connectors are available upon request.  
Photographs are not to scale and do not represent detailed images of the respective products.



New

## Industrial Ethernet EC FD Patchcord RJ45 on free conductor end



Info

- Industrial Ethernet cable
- Suitable for drag chains

### Benefits

- Non-permanent connections allow for easy change of equipment
- For directly connecting two electric components
- CAT.5-Performance

### Application range

- Suitable for EtherCAT and EtherNet/IP applications
- Suitable for use in industrial applications
- For indoor use
- For highly flexible applications
- Automation technology

### Product features

- Meets the requirements according to CAT.5e, ISO/IEC 11801 and EN 50173, Class D
- 2pair: 10/ 100 Mbit/s for Industrial Ethernet

### Design

- AWG 26 (19-wire)
- Overall screening with copper braid and plastic-laminated aluminium foil
- Outer sheath made of PUR
- Colour: green (based on RAL 6018)
- Pre-assembled patchcord with a RJ45 connector on free conductor end

### Technical data



#### Minimum bending radius

Flexing: 8 x outer diameter  
Fixed installation: 4 x outer diameter



#### Protection rating

IP 20



#### Characteristic impedance

100 Ohm +- 15%



#### Temperature range

During installation: -30°C to +50°C  
Fixed installation: -40°C to +80°C

Article number	Article designation	Number of pairs and AWG per conductor	Length (m)	Copper index (kg/km)
<b>Industrial Ethernet EC FD Patchcord RJ45 on free conductor end</b>				
2171771	IE-EC-5-RJ45-0,5-P-2-26-FD-OE	2x2xAWG26	0.5	10.0
2171772	IE-EC-5-RJ45-1-P-2-26-FD-OE	2x2xAWG26	1.0	20.0
2171773	IE-EC-5-RJ45-2-P-2-26-FD-OE	2x2xAWG26	2.0	40.0
2171774	IE-EC-5-RJ45-3-P-2-26-FD-OE	2x2xAWG26	3.0	60.0
2171775	IE-EC-5-RJ45-5-P-2-26-FD-OE	2x2xAWG26	5.0	100.0
2171776	IE-EC-5-RJ45-10-P-2-26-FD-OE	2x2xAWG26	10.0	200.0
2171777	IE-EC-5-RJ45-20-P-2-26-FD-OE	2x2xAWG26	20.0	400.0

Unless specified otherwise, the shown product values are nominal values. Detailed values (e.g. tolerances) are available upon request.

Copper price basis: EUR 150/100kg. Refer to catalogue appendix T 17 for the definition and calculation of copper-related surcharges.

Other lengths and types of connectors are available upon request.

Photographs are not to scale and do not represent detailed images of the respective products.



New

## Industrial Ethernet EC Patchcord M8



Info

- For EtherCAT applications



### Benefits

- Non-permanent connections allow for easy change of equipment
- For directly connecting two electric components
- Flexible use

### Application range

- Suitable for use in industrial applications
- Especially for EtherCat applications
- For indoor use

### Design

- Stranded conductor, 7-wire, 2x2xAWG26/7
- Overall screening with copper braid and plastic-laminated aluminium foil
- Pre-assembled patchcord with a M8 connector on both sides
- Colour: green (based on RAL 6018)

### Technical data

- Peak operating voltage**  
max. 100 V (not for power applications)
- Minimum bending radius**  
Fixed installation: 4 x outer diameter  
Flexing: 8 x outer diameter
- Characteristic impedance**  
100 Ohm +/- 15%
- Temperature range**  
Fixed installation: -30°C to +80°C  
Flexing: -5°C to +50°C

Article number	Article designation	Number of pairs and AWG per conductor	Length (m)
<b>Angled connector on straight connector</b>			
2171350	IE-EC-5-M8-A-0,5-Y-2-26-7-M8-S	2x2xAWG26	0.5
2171351	IE-EC-5-M8-A-1-Y-2-26-7-M8-S	2x2xAWG26	1.0
2171352	IE-EC-5-M8-A-2-Y-2-26-7-M8-S	2x2xAWG26	2.0
2171353	IE-EC-5-M8-A-3-Y-2-26-7-M8-S	2x2xAWG26	3.0
2171354	IE-EC-5-M8-A-5-Y-2-26-7-M8-S	2x2xAWG26	5.0
2171355	IE-EC-5-M8-A-7-Y-2-26-7-M8-S	2x2xAWG26	7.0
2171356	IE-EC-5-M8-A-10-Y-2-26-7-M8-S	2x2xAWG26	10.0
2171357	IE-EC-5-M8-A-15-Y-2-26-7-M8-S	2x2xAWG26	15.0
2171358	IE-EC-5-M8-A-20-Y-2-26-7-M8-S	2x2xAWG26	20.0
<b>Straight connector on straight connector</b>			
2171300	IE-EC-5-M8-S-0,5-Y-2-26-7-M8-S	2x2xAWG26	0.5
2171301	IE-EC-5-M8-S-1-Y-2-26-7-M8-S	2x2xAWG26	1.0
2171302	IE-EC-5-M8-S-2-Y-2-26-7-M8-S	2x2xAWG26	2.0
2171303	IE-EC-5-M8-S-3-Y-2-26-7-M8-S	2x2xAWG26	3.0
2171306	IE-EC-5-M8-S-10-Y-2-26-7-M8-S	2x2xAWG26	10.0
2171304	IE-EC-5-M8-S-5-Y-2-26-7-M8-S	2x2xAWG26	5.0
2171305	IE-EC-5-M8-S-7-Y-2-26-7-M8-S	2x2xAWG26	7.0
2171307	IE-EC-5-M8-S-15-Y-2-26-7-M8-S	2x2xAWG26	15.0
2171308	IE-EC-5-M8-S-20-Y-2-26-7-M8-S	2x2xAWG26	20.0

Unless specified otherwise, the shown product values are nominal values. Detailed values (e.g. tolerances) are available upon request. Copper price basis: EUR 150/100kg. Refer to catalogue appendix T17 for the definition and calculation of copper-related surcharges. Other lengths and types of connectors are available upon request. Photographs are not to scale and do not represent detailed images of the respective products.



New

## Industrial Ethernet EC Patchcord M8 on open conductor end



Info

- For EtherCAT applications

### Benefits

- Non-permanent connections allow for easy change of equipment
- For directly connecting two electric components
- Flexible use

### Application range

- Suitable for use in industrial applications
- For indoor use
- Especially for EtherCat applications

### Design

- Stranded conductor, 7-wire, 2x2xAWG26/7
- Overall screening with copper braid and plastic-laminated aluminium foil
- Pre-assembled patchcord with a M8 connector on free conductor end
- Colour: green (based on RAL 6018)

### Technical data



#### Minimum bending radius

Fixed installation: 4 x outer diameter  
Flexing: 8 x outer diameter



#### Characteristic impedance

100 Ohm +/- 15%



#### Temperature range

Fixed installation: -30°C to +80°C  
Flexing: -5°C to +50°C

Article number	Article designation	Number of pairs and AWG per conductor	Length (m)
<b>Angled connector on free conductor end</b>			
2171370	IE-EC-5-M8-A-0,5-Y-2-26-7-OE	2x2xAWG26	0.5
2171371	IE-EC-5-M8-A-1-Y-2-26-7-OE	2x2xAWG26	1.0
2171372	IE-EC-5-M8-A-2-Y-2-26-7-OE	2x2xAWG26	2.0
2171373	IE-EC-5-M8D-A-3-Y-2-26-7-OE	2x2xAWG26	3.0
2171374	IE-EC-5-M8-A-5-Y-2-26-7-OE	2x2xAWG26	5.0
2171375	IE-EC-5-M8-A-7-Y-2-26-7-OE	2x2xAWG26	7.0
2171376	IE-EC-5-M8-A-10-Y-2-26-7-OE	2x2xAWG26	10.0
2171377	IE-EC-5-M8-A-15-Y-2-26-7-OE	2x2xAWG26	15.0
2171378	IE-EC-5-M8-A-20-Y-2-26-7-OE	2x2xAWG26	20.0
<b>straight connector on free conductor end</b>			
2171320	IE-EC-5-M8-S-0,5-Y-2-26-7-OE	2x2xAWG26	0.5
2171321	IE-EC-5-M8-S-1-Y-2-26-7-OE	2x2xAWG26	1.0
2171322	IE-EC-5-M8-S-2-Y-2-26-7-OE	2x2xAWG26	2.0
2171323	IE-EC-5-M8-S-3-Y-2-26-7-OE	2x2xAWG26	3.0
2171324	IE-EC-5-M8-S-5-Y-2-26-7-OE	2x2xAWG26	5.0
2171325	IE-EC-5-M8-S-7-Y-2-26-7-OE	2x2xAWG26	7.0
2171326	IE-EC-5-M8-S-10-Y-2-26-7-OE	2x2xAWG26	10.0
2171327	IE-EC-5-M8-S-15-Y-2-26-7-OE	2x2xAWG26	15.0
2171328	IE-EC-5-M8-S-20-Y-2-26-7-OE	2x2xAWG26	20.0

Unless specified otherwise, the shown product values are nominal values. Detailed values (e.g. tolerances) are available upon request. Copper price basis: EUR 150/100kg. Refer to catalogue appendix T17 for the definition and calculation of copper-related surcharges. Other lengths and types of connectors are available upon request. Photographs are not to scale and do not represent detailed images of the respective products.

### Accessories

- Field mountable S/A connectors M8 refer to page 114
- BUS M12 connectors that can be assembled
- Connector RJ45 Cat.6<sub>A</sub> FM for FD-cables



**New**

## Industrial Ethernet EC FD Patchcord M8

**Info**

- Industrial Ethernet cable
- Suitable for drag chains



### Benefits

- Non-permanent connections allow for easy change of equipment
- For directly connecting two electric components
- CAT.5-Performance

### Application range

- Suitable for EtherCAT and EtherNet/IP applications
- Suitable for use in industrial applications
- For indoor use
- For highly flexible applications
- Automation technology

### Product features

- Meets the requirements according to CAT.5e, ISO/IEC 11801 and EN 50173, Class D
- 2pair: 10/ 100 Mbit/s for Industrial Ethernet

### Design

- AWG 26 (19-wire)
- Overall screening with copper braid and plastic-laminated aluminium foil
- Outer sheath made of PUR
- Colour: green (based on RAL 6018)
- Pre-assembled patchcord with a M8 connector on both sides

### Technical data

- Minimum bending radius**  
Flexing: 8 x outer diameter  
Fixed installation: 4 x outer diameter
- Protection rating**  
IP 67
- Characteristic impedance**  
100 Ohm +/- 15%
- Temperature range**  
During installation: -30°C to +50°C  
Fixed installation: -40°C to +80°C

Article number	Article designation	Number of pairs and AWG per conductor	Length (m)	Copper index (kg/km)
<b>Straight connector on straight connector</b>				
2171700	IE-EC-5-M8-S-0,5-P-2-26-FD-M8-S	2x2xAWG26	0,5	10,0
2171701	IE-EC-5-M8-S-1-P-2-26-FD-M8-S	2x2xAWG26	1,0	20,0
2171702	IE-EC-5-M8-S-2-P-2-26-FD-M8-S	2x2xAWG26	2,0	40,0
2171703	IE-EC-5-M8-S-3-P-2-26-FD-M8-S	2x2xAWG26	3,0	60,0
2171704	IE-EC-5-M8-S-5-P-2-26-FD-M8-S	2x2xAWG26	5,0	100,0
2171705	IE-EC-5-M8-S-7-P-2-26-FD-M8-S	2x2xAWG26	7,0	140,0
2171706	IE-EC-5-M8-S-10-P-2-26-FD-M8-S	2x2xAWG26	10,0	200,0
2171707	IE-EC-5-M8-S-15-P-2-26-FD-M8-S	2x2xAWG26	15,0	300,0
2171708	IE-EC-5-M8-S-20-P-2-26-FD-M8-S	2x2xAWG26	20,0	400,0
<b>Angled connector on straight connector</b>				
2171718	IE-EC-5-M8-A-0,5-P-2-26-FD-M8-S	2x2xAWG26	0,5	10,0
2171719	IE-EC-5-M8-A-1-P-2-26-FD-M8-S	2x2xAWG26	1,0	20,0
2171720	IE-EC-5-M8-A-2-P-2-26-FD-M8-S	2x2xAWG26	2,0	40,0
2171721	IE-EC-5-M8-A-3-P-2-26-FD-M8-S	2x2xAWG26	3,0	60,0
2171722	IE-EC-5-M8-A-5-P-2-26-FD-M8-S	2x2xAWG26	5,0	100,0
2171723	IE-EC-5-M8-A-7-P-2-26-FD-M8-S	2x2xAWG26	7,0	140,0
2171724	IE-EC-5-M8-A-10-P-2-26-FD-M8-S	2x2xAWG26	10,0	200,0
2171725	IE-EC-5-M8-A-15-P-2-26-FD-M8-S	2x2xAWG26	15,0	300,0
2171726	IE-EC-5-M8-A-20-P-2-26-FD-M8-S	2x2xAWG26	20,0	400,0

Unless specified otherwise, the shown product values are nominal values. Detailed values (e.g. tolerances) are available upon request.  
Copper price basis: EUR 150/100kg. Refer to catalogue appendix T17 for the definition and calculation of copper-related surcharges.  
Other lengths and types of connectors are available upon request.  
Photographs are not to scale and do not represent detailed images of the respective products.



New

## Industrial Ethernet EC FD Patchcord M8 on free conductor end



Info

- Industrial Ethernet cable
- Suitable for drag chains

### Benefits

- Non-permanent connections allow for easy change of equipment
- For directly connecting two electric components
- CAT.5-Performance

### Application range

- Suitable for EtherCAT and EtherNet/IP applications
- Suitable for use in industrial applications
- For indoor use
- For highly flexible applications
- Automation technology

### Product features

- Meets the requirements according to CAT.5e, ISO/IEC 11801 and EN 50173, Class D
- 2pair: 10/100 Mbit/s for Industrial Ethernet

### Design

- AWG 26 (19-wire)
- Overall screening with copper braid and plastic-laminated aluminium foil
- Outer sheath made of PUR
- Colour: green (based on RAL 6018)
- Pre-assembled patchcord with a M8 connector on free conductor end

### Technical data



#### Minimum bending radius

Flexing: 8 x outer diameter  
Fixed installation: 4 x outer diameter



#### Protection rating

IP 67



#### Characteristic impedance

100 Ohm +/- 15%



#### Temperature range

During installation: -30°C to +50°C  
Fixed installation: -40°C to +80°C

Article number	Article designation	Number of pairs and AWG per conductor	Length (m)	Copper index (kg/km)
<b>straight connector on free conductor end</b>				
2171709	IE-EC-5-M8-S-0,5-P-2-26-FD-OE	2x2xAWG26	0.5	10.0
2171710	IE-EC-5-M8-S-1-P-2-26-FD-OE	2x2xAWG26	1.0	20.0
2171711	IE-EC-5-M8-S-2-P-2-26-FD-OE	2x2xAWG26	2.0	40.0
2171712	IE-EC-5-M8-S-3-P-2-26-FD-OE	2x2xAWG26	3.0	60.0
2171713	IE-EC-5-M8-S-5-P-2-26-FD-OE	2x2xAWG26	5.0	100.0
2171714	IE-EC-5-M8-S-7-P-2-26-FD-OE	2x2xAWG26	7.0	140.0
2171715	IE-EC-5-M8-S-10-P-2-26-FD-OE	2x2xAWG26	10.0	200.0
2171716	IE-EC-5-M8-S-15-P-2-26-FD-OE	2x2xAWG26	15.0	300.0
2171717	IE-EC-5-M8-S-20-P-2-26-FD-OE	2x2xAWG26	20.0	400.0
<b>Angled connector on free conductor end</b>				
2171727	IE-EC-5-M8-A-0,5-P-2-26-FD-OE	2x2xAWG26	0.5	10.0
2171728	IE-EC-5-M8-A-1-P-2-26-FD-OE	2x2xAWG26	1.0	20.0
2171729	IE-EC-5-M8-A-2-P-2-26-FD-OE	2x2xAWG26	2.0	40.0
2171730	IE-EC-5-M8-A-3-P-2-26-FD-OE	2x2xAWG26	3.0	60.0
2171731	IE-EC-5-M8-A-5-P-2-26-FD-OE	2x2xAWG26	5.0	100.0
2171732	IE-EC-5-M8-A-7-P-2-26-FD-OE	2x2xAWG26	7.0	140.0
2171733	IE-EC-5-M8-A-10-P-2-26-FD-OE	2x2xAWG26	10.0	200.0
2171734	IE-EC-5-M8-A-15-P-2-26-FD-OE	2x2xAWG26	15.0	300.0
2171735	IE-EC-5-M8-A-20-P-2-26-FD-OE	2x2xAWG26	20.0	400.0

Unless specified otherwise, the shown product values are nominal values. Detailed values (e.g. tolerances) are available upon request.  
Copper price basis: EUR 150/100kg. Refer to catalogue appendix T17 for the definition and calculation of copper-related surcharges.  
Other lengths and types of connectors are available upon request.  
Photographs are not to scale and do not represent detailed images of the respective products.





## Connector RJ45 CAT.5 Hirose TM11

### Product features

- Screened version
- Suitable for stranded conductors (AWG26)
- Included: bend protection and guide plate
- Anti-kink protection: beige
- Max. outer sheath diameter: 5.8 mm



Article number	Article designation
<b>Connector RJ45 CAT.5 Hirose TM11</b>	
CE6321	Connector RJ45 CAT.5 Hirose TM11

Hirose is a registered trademark of the HIROSE ELECTRIC Group  
Other colours are available upon request.  
Photographs are not to scale and do not represent detailed images of the respective products.

### Accessories

- Crimping tool RJ45 Hirose



## Connector RJ45 CAT.5 Stewart SS37

### Product features

- Screened version
- Suitable for stranded conductors (AWG26)
- Included: bend protection and guide plate
- Anti-kink protection: light grey
- Max. outer sheath diameter: 5.72 mm



Article number	Article designation
<b>Connector RJ45 CAT.5 Stewart SS37</b>	
CE6323	Connector RJ45 CAT.5 Stewart SS37

Stewart is a registered trademark of Bel Fuse Inc.  
Other colours are available upon request.  
Photographs are not to scale and do not represent detailed images of the respective products.

### Accessories

- Crimping tool RJ45 Stewart



## Field-Terminable Connector RJ45 CAT.5e FM45

### Product features

- Screened version
- FM45 is a tool-free switchable, field-terminable RJ45 Connector with IDC contacting and CAT.5e performance. The 8-pin connection is tension and vibration-resistant, and can be re-switched. The connecting block can accommodate both screened and unscreened cable of up to 8 mm diameter.
- Suitable for AWG 23 - 26, AWG 22 possible with restrictions
- IDC/piercing terminal according to 60352-4
- Suitable for solid and stranded conductors
- Suitable for use in industrial applications
- Protection rating: IP20



Article number	Article designation
<b>Field-Terminable Connector RJ45 CAT.5e FM45</b>	
21700540	Field-Terminable Connector RJ45 CAT.5e FM45

Photographs are not to scale and do not represent detailed images of the respective products.



## Connector RJ45 CAT.6 Hirose TM21

### Product features

- Channel Class E up to 250 MHz (CAT.6)
- Fully screened
- Conductor: Ø 0.5 mm solid wire: AWG 24 & 26; guide plate for 1.1 mm diameter wire; cable outer diameter: 6.6 mm
- Easy to handle
- Included: bend protection and guide plate
- Anti-kink protection: beige
- Suitable for solid and stranded conductors



Article number	Article designation
<b>Connector RJ45 CAT.6 Hirose TM21</b>	
CE6324	Connector RJ45 CAT.6 Hirose TM21

Hirose is a registered trademark of the HIROSE ELECTRIC Group  
Other colours are available upon request.  
Photographs are not to scale and do not represent detailed images of the respective products.

### Accessories

- Crimping tool RJ45 Hirose



New

## Connector RJ45 Cat.5e for Profinet



Info

- For PROFINET applications
- Installation without tools

### Product features

- For PROFINET applications
- Housing: zinc die-casting, grey
- By a multi-level relief setting the connector can accommodate a cable diameter from 5,0 mm up to 9,0 mm
- Suitable for stranded cores with AWG27/7 -22/7 and for solid conductors with AWG24/1- 22/1
- Suitable for use in industrial applications
- Colour-coded in accordance with PROFINET for Cat.5 applications

### Norm references / Approvals

- Field assembly Industrial Ethernet connector, RJ45 according to IEC 60603-7-51
- UL-listed (E-File E353543)

### Technical data



**Protection rating**  
IP 20



**Ambient temperature (operation)**  
-40°C to +85°C

Article number	Article designation	Min. outer diameter (mm)	Max. outer diameter (mm)	Min. Core diameter in mm	Max. Core diameter in mm	AWG solid	AWG 7-wire
<b>Connector RJ45 Cat.5e for Profinet</b>							
21700605	ED-IE-AX-5-PN-20-FC	5.0	9.0	1.60	1.0	24 - 22	27 - 22

Photographs are not to scale and do not represent detailed images of the respective products.  
10 pieces in one blister



New

## Connector RJ45 angled Cat.5e for Profinet



Info

- For PROFINET applications
- Installation without tools
- 4 different angled cable outlets possible

### Product features

- For PROFINET applications
- Cable outlet in 4 different 90° angles possible
- Housing: zinc die-casting, grey
- Suitable for stranded cores with AWG27/7 -22/7 and for solid conductors with AWG24/1- 22/1
- Suitable for use in industrial applications
- Colour-coded in accordance with PROFINET for Cat.5 applications

### Norm references / Approvals

- Field assembly Industrial Ethernet connector, RJ45 according to IEC 60603-7-51

### Technical data



**Protection rating**  
IP 20



**Ambient temperature (operation)**  
-40°C to +85°C

Article number	Article designation	Min. outer diameter (mm)	Max. outer diameter (mm)	Min. Core diameter in mm	Max. Core diameter in mm	AWG solid	AWG 7-wire
<b>Connector RJ45 angled Cat.5e for Profinet</b>							
21700638	ED-IE-90-6A-PN-20-FC	5.5	10.0	1.00	1.6	24 - 22	27 - 22

Photographs are not to scale and do not represent detailed images of the respective products.



**New**

## Connector RJ45 Cat.6<sub>A</sub> fieldmountable



**Info**

- CAT.6<sub>A</sub> qualified for 10Gbit/s
- Installation without tools

- Product features**
- Field assembly Industrial Ethernet connector, RJ45 according to IEC 60603-7-51
  - Qualified for 10 Gigabit Ethernet
  - Housing: zinc die-casting, grey
  - By a multi-level relief setting the connector can accommodate a cable diameter from 5,0 mm up to 9,0 mm

- Suitable for stranded cores with AWG27/7 -22/7 and for solid conductors with AWG24/1- 22/1
- Suitable for use in industrial applications
- Available with colour code T568A or T568B

- Norm references / Approvals**
- Field assembly Industrial Ethernet connector, RJ45 according to IEC 60603-7-51
  - UL-listed (E-File E353543)

**Technical data**

**IP** Protection rating  
IP 20

**0** Ambient temperature (operation)  
-40°C to +85°C

Article number	Article designation	Min. outer diameter (mm)	Max. outer diameter (mm)	Min. Core diameter in mm	Max. Core diameter in mm	AWG solid	AWG 7-wire	AWG 19-wire
<b>RJ45 connector acc. to T568A</b>								
21700600	EPIC® DATA ED-IE-AX-6A-A-20-FC	5.0	9.0	1.00	1.6	24 - 22	27 - 22	
<b>RJ45 connector acc. to T568A, specifically for cables with 19-wire cores</b>								
21700615	EPIC DATA ED-IE-AX-6 <sub>A</sub> -A-20-FD-FC	5.0	9.0	0.85	1.1	26 - 24	27 - 24	26
<b>RJ45 connector acc. to T568B</b>								
21700601	EPIC® DATA ED-IE-AX-6A-B-20-FC	5.0	9.0	1.00	1.6	24 - 22	27 - 22	
<b>RJ45 connector acc. to T568B, specifically for cables with 19-wire cores</b>								
21700616	EPIC DATA ED-IE-AX-6 <sub>A</sub> -B-20-FD-FC	5.0	9.0	0.85	1.1	26 - 24	27 - 24	26

Photographs are not to scale and do not represent detailed images of the respective products.  
10 pieces in one blister  
An approval is necessary for 19-wire cables by Lapp Group



**New**

## Connector RJ45 angled Cat.6<sub>A</sub> fieldmountable



**Info**

- CAT.6<sub>A</sub> qualified for 10Gbit/s
- Installation without tools
- 4 different angled cable outlets possible

- Product features**
- Cable outlet in 4 different 90° angles possible
  - Qualified for 10 Gigabit Ethernet
  - Housing: zinc die-casting, grey
  - Suitable for stranded cores with AWG27/7 -22/7 and for solid conductors with AWG24/1- 22/1
  - Suitable for use in industrial applications
  - Available with colour code T568A or T568B

- Norm references / Approvals**
- Field assembly Industrial Ethernet connector, RJ45 according to IEC 60603-7-51

**Technical data**

**IP** Protection rating  
IP 20

**0** Ambient temperature (operation)  
-40°C to +85°C

Article number	Article designation	Min. outer diameter (mm)	Max. outer diameter (mm)	Min. Core diameter in mm	Max. Core diameter in mm	AWG solid	AWG 7-wire	AWG 19-wire
<b>RJ45 connector acc. to T568A</b>								
21700636	ED-IE-90-6A-A-20-FC	5.5	10.0	1.00	1.6	24 - 22	27 - 22	
<b>RJ45 connector acc. to T568A, specifically for cables with 19-wire cores</b>								
21700639	ED-IE-90-6A-A-20-FD-FC	5.5	10.0	0.85	1.1	26 - 24	27 - 24	26
<b>RJ45 connector acc. to T568B</b>								
21700637	ED-IE-90-6A-B-20-FC	5.5	10.0	1.00	1.6	24 - 22	27 - 22	
<b>RJ45 connector acc. to T568B, specifically for cables with 19-wire cores</b>								
21700640	ED-IE-90-6A-B-20-FD-FC	5.5	10.0	0.85	1.1	26 - 24	27 - 24	26

Photographs are not to scale and do not represent detailed images of the respective products.  
10 pieces in one blister  
An approval is necessary for 19-wire cables by Lapp Group

New

## Connector industry RJ45 Cat.6<sub>A</sub> 10 IP68



Info

- CAT.6<sub>A</sub> qualified for 10Gbit/s
- Installation without tools

### Product features

- Housing: brass nickel plated
- Qualified for 10 Gigabit Ethernet
- Suitable for stranded cores with AWG27/7 -22/7 and for solid conductors with AWG26/1- 22/1
- By a multi-level relief setting the connector can accommodate a cable diameter from 5,0 mm up to 9,0 mm

### Norm references / Approvals

- Field assembly Industrial Ethernet connector, RJ45 according to IEC 60603-7-51
- UL-listed (E-File E353543)

### Technical data



**Protection rating**  
IP 68



**Ambient temperature (operation)**  
Plug/socket -40°C to +70°C  
circular housing: -40°C to +85°C

Article number	Article designation
<b>circular connector (male) inclusive RJ45 connector</b>	
21700630	ED-IE-AX-RJ45-6A-B-68-FC
<b>dust cap for RJ45 connector</b>	
21700631	ED-IE-AX-RJ45-AC-DC
<b>circular bulkhead housing inclusive RJ45 Modul acc. to T568B</b>	
21700632	ED-IE-RJ45F-6A-B-68-FC
<b>dust cap for RJ45 Modul</b>	
21700633	ED-IE-RJ45F-AC-DC

Photographs are not to scale and do not represent detailed images of the respective products.



New

## Connector M 12 x-coded Cat.6<sub>A</sub> 10G fieldmountable



Info

- CAT.6<sub>A</sub> qualified for 10Gbit/s
- Installation without tools

### Product features

- Field assembly Industrial Ethernet connector, M12 "X"-coded according to IEC 61076-2-109
- Qualified for 10 Gigabit Ethernet
- Suitable for use in industrial applications
- Robust and vibrations- resistant
- Housing: zinc die-casting, grey
- Insulation displacement contacts for conductor diameter of AWG27/7 - AWG22/7 and AWG24/1 - AWG22/1; max. outer diameter 9,7 mm
- Toolfree installation, small and compact design

### Norm references / Approvals

- Acc. to standard IEC 61076-2-109
- Data transmission is conform to category Cat.6<sub>A</sub> acc. to ISO/IEC 11801:2010

### Technical data



**Protection rating**  
IP 67



**Ambient temperature (operation)**  
Plug/socket  
-40°C to +85°C

Article number	Article designation
<b>M12 x-coded male connector straight</b>	
21700602	ED-IE-AX-M12X-6A-67-FC
<b>M12 x-coded female connector straight</b>	
21700621	ED-IE-AX-M12XF-6 <sub>A</sub> -67-FC
<b>M12 x-coded female connector straight for wall mounting</b>	
21700622	ED-IE-AX-M12XF-RM-6 <sub>A</sub> -67-FC

Photographs are not to scale and do not represent detailed images of the respective products.



New

**EPIC® DATA CCR FA**



**Info**

- Cable coupler round class F<sub>A</sub>
- Installation without tools

**Product features**

- Field mountable cable coupler for data cables up to Cat.7<sub>A</sub>
- Compact, round design
- Qualified for 10 Gigabit Ethernet
- Suitable for use in industrial applications
- Robust and vibrations-resistant
- Housing: zinc die-casting, grey

- Insulation displacement contacts for conductor diameter of AWG24/7 - AWG22/7 and AWG24/1 - AWG22/1; max. outer diameter 9,7 mm

**Norm references / Approvals**

- Compliance to class F<sub>A</sub> up to 1000 MHz in connection with Cat.7<sub>A</sub> cables
- Data transmission is conform to category Cat.7<sub>A</sub> acc. to ISO/IEC 11801

**Technical data**

- IP Protection rating**  
IP 65 / IP 67
- Ambient temperature (operation)**  
Plug/socket  
-40°C to +85°C

Article number	Article designation	Min. outer diameter (mm)	Max. outer diameter (mm)	Min. Core diameter in mm	Max. Core diameter in mm	AWG solid	AWG 7-wire
<b>EPIC® DATA CCR FA</b>							
21700623	EPIC® DATA CCR FA	5.0	9.7	0.85	1.6	24 - 22	24 - 22

Photographs are not to scale and do not represent detailed images of the respective products.



New

**Easy Connect RJ45 Modul Cat.6<sub>A</sub> 10G**

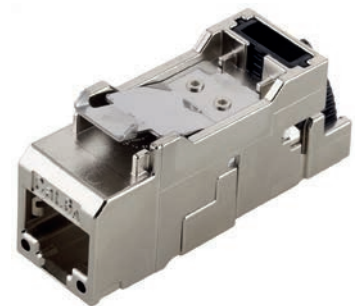

**Product features**

- Field assembly Industrial Ethernet module RJ45 according to IEC 60603-7-51
- Qualified for 10 Gigabit Ethernet
- Housing: zinc die-casting, grey
- By a multi-level relief setting the connector can accommodate a cable diameter from 5,0 mm up to 9,0 mm

- Suitable for stranded cores with AWG27/7 -22/7 and for solid conductors with AWG26/1- 22/1
- Suitable for use in industrial applications
- Available with colour code T568A or T568B

**Technical data**

- IP Protection rating**  
IP 20
- Ambient temperature (operation)**  
-40°C to +70°C

Article number	Article designation
<b>RJ45 Modul acc. to T568A</b>	
21700611	EPIC DATA ED-IE-AX-6A-B-20-FC
<b>RJ45 Modul acc. to T568B</b>	
21700612	ED-IE-AX-RJ45F-6A-B-FC

Photographs are not to scale and do not represent detailed images of the respective products.



**New**

## Easy Connect Hutschienen Adapter Cat.6<sub>A</sub>



### Product features

- Plastic housing including Easy Connect RJ45 Modul Cat.6A 10G
- Suitable for use in industrial applications
- Integrated strain relief for cable O.D. to 9 mm
- Colour: light grey (RAL 7035)
- Suitable for stranded cores with AWG27/7 -22/7 and for solid conductors with AWG26/1- 22/1

### Norm references / Approvals

- Field assembly Industrial Ethernet module RJ45 according to IEC 60603-7-51

### Technical data



**Protection rating**  
IP 20



**Ambient temperature (operation)**  
-40°C to +70°C

Article number	Article designation
<b>Inclusive RJ45 Modul acc. to T568A</b> 21700613	EPIC DATA HS RJ45 F 10G B
<b>Inclusive RJ45 Modul acc. to T568B</b> 21700614	EPIC DATA HS RJ45 F 10G B

Photographs are not to scale and do not represent detailed images of the respective products.





**HITRONIC®**  
Optical transmission systems



Introduction .....	202
Quickfinder .....	203
HITRONIC® Product Overview .....	211
POF selection table: connector – cable – tools – accessories .....	213
PCF selection table: connector – cable – tools – accessories .....	215
Selection criteria .....	216
Fibre Optic – Transmission Overview .....	217
Special Applications and Services .....	218
<b>Product Pages</b> .....	<b>219</b>

For current information see [www.lappgroup.com/products](http://www.lappgroup.com/products)

## Fibre optic cables

### Introduction

The optical transmission of messages in FOC operates according to the principle of „total internal reflection.“ The reflection is created by the fact that an optically thinner cladding is placed around the light conducting core on whose interface the light totally reflects and is thereby conducted through the FOC.

Although the principle of optical message transmission has been known for a long time, not until recent years was one able to develop, produce and commercially use low loss FOCs. In a time when the need for rapid and secure communications networks is continually growing we can neither imagine a world without the transmission medium FOC nor can it be replaced.

#### Advantages of fibre optics over copper-based transmission

- Protection against electromagnetic interferences, i.e. cable routing can be carried out without consideration of possibly occurring sources of electromagnetic interference

- rapid made-to-measure preparation of plastic FOC, simple on-site plug-in connector installation
- Potential separation, that is potential delays are not possible
- No crosstalk and high security against listening in
- Small dimensions and minimal weight (up to 2.2 mm outside diameter and/or 4g/m for plastic FOC in SIMPLEX model)

Among fibre optic cables there is a difference based on the material used between plastic fibres (POF), fibres made of silica glass with optical plastic cladding (PCF) and fibres made of pure silica glass (glass fibre or GOF).

Mainly for use in the industrial area, Lapp Kabel offers FOCs made of glass or plastic and/or hybrid cables.

A portion of these cables is constructively laid for heavy deployment in the energy supply chain. The overall concept of your data transmission line determines whether glass or plastic fibre optic cables are used. We offer you

suitable plug-in connectors, tools and pre-fabricated FOC patch cables that match the cables being used.

#### Typical deployment areas for POF and PCF FOCs:

- Bus systems in automation
- Machine construction and plant engineering
- Building technology

#### Because of their special characteristics POF-FOC are used

- high demands at data security
- for conditions where space is limited

#### Typical application areas for GOF FOCs:

- Everywhere where large amounts of data must be transmitted at high speed over distances of approx. 60 m to several kilometres. For example in
- Local Area Networks (LAN)
  - Metropolitan Area Networks (MAN)
  - Wide Area Networks (WAN)

### Colour-codes of fibres

Standard		TIA-598	
1 red		1 blue	
2 green		2 orange	
3 blue		3 green	
4 yellow		4 brown	
5 grey		5 grey	
6 violet		6 white	
7 brown		7 red	
8 orange		8 black	
9 white		9 yellow	
10 pink		10 violet	
11 black		11 pink	
12 turquoise		12 turquoise	

## Quickfinder

FO-fibre type	Cable type/standardisation (DIN VDE 0888)	Area of Installation	Cabling	Fibre Specification	No. of fibres	Max. tensile force (long-term) in [N]	Outer sheath material	Product Benefits	Article designation	Article number	Page			
GOF – Glass Optical Fibre	Outdoor Cable A-DQ(ZN)B2Y (loose tube, 4 – 24 fibres)	Outdoor	static	Multimode 50/125 µm OM3	4	1500	PE	compact, central loose tube, direct burial, UV resistance, halogen-free, rodent and moisture protection, watertight, low friction	HITRONIC® HQN1500 4 G 50/125 OM3	27600304	239			
					8				HITRONIC® HQN1500 8 G 50/125 OM3	27600308	239			
					12				HITRONIC® HQN1500 12 G 50/125 OM3	27600312	239			
					24				HITRONIC® HQN1500 24 G 50/125 OM3	27600324	239			
				Multimode 50/125 µm OM2	4	1500	PE	compact, central loose tube, direct burial, UV resistance, halogen-free, rodent and moisture protection, watertight, low friction	HITRONIC® HQN1500 4 G 50/125 OM2	27600204	239			
					8				HITRONIC® HQN1500 8 G 50/125 OM2	27600208	239			
					12				HITRONIC® HQN1500 12 G 50/125 OM2	27600212	239			
					24				HITRONIC® HQN1500 24 G 50/125 OM2	27600224	239			
				Multimode 62.5/125 µm OM1	4	1500	PE	compact, central loose tube, direct burial, UV resistance, halogen-free, rodent and moisture protection, watertight, low friction	HITRONIC® HQN1500 4 G 62.5/125 OM1	27600104	239			
					8				HITRONIC® HQN1500 8 G 62.5/125 OM1	27600108	239			
					12				HITRONIC® HQN1500 12 G 62.5/125 OM1	27600112	239			
					24				HITRONIC® HQN1500 24 G 62.5/125 OM1	27600124	239			
				Singlemode 9/125 µm OS2	4	1500	PE	compact, central loose tube, direct burial, UV resistance, halogen-free, rodent and moisture protection, watertight, low friction	HITRONIC® HQN1500 4 E 9/125 OS2	27600904	239			
					8				HITRONIC® HQN1500 8 E 9/125 OS2	27600908	239			
					12				HITRONIC® HQN1500 12 E 9/125 OS2	27600912	239			
					24				HITRONIC® HQN1500 24 E 9/125 OS2	27600924	239			
	Outdoor Cable A-DQ(ZN)B2Y (loose tube, 12 – 144 fibres)	Outdoor	static	Multimode 50/125 µm OM2	24	1500	PE	compact, stranded loose tubes, UV resistance, halogen-free, rodent and moisture protection, low friction, suitable for blowing technology	HITRONIC® HVN1500 2x12 G 50/125 OM2	26601224	240			
					48				HITRONIC® HVN1500 4x12 G 50/125 OM2	26601248	240			
					24				HITRONIC® HVN1500 2x12 G 62.5/125 OM1	26601124	240			
					48				HITRONIC® HVN1500 4x12 G 62.5/125 OM1	26601148	240			
				Singlemode 9/125 µm OS2	12	1500	PE	compact, stranded loose tubes, UV resistance, halogen-free, rodent and moisture protection, low friction, suitable for blowing technology	HITRONIC® HVN1500 2x6 E 9/125 OS2	26601912	240			
					24				HITRONIC® HVN1500 2x12 E 9/125 OS2	26601924	240			
					48				HITRONIC® HVN1500 4x12 E 9/125 OS2	26601948	240			
					72				HITRONIC® HVN2000 6x12 E 9/125 OS2	26601972	240			
					96	2000	PE	compact, stranded loose tubes, UV resistance, halogen-free, rodent and moisture protection, low friction, suitable for blowing technology	HITRONIC® HVN2000 8x12 E 9/125 OS2	26601996	240			
					144				HITRONIC® HVN2000 12x12 E 9/125 OS2	26601944	240			
					12				500	PE	compact, stranded loose tubes, reduced dimensions, UV resistance, halogen-free, moisture protection, low friction, suitable for blowing technology	HITRONIC® HVN-Mini500 1x12 E9/125 OS2	26609912	241
					24							HITRONIC® HVN-Mini500 2x12 E9/125 OS2	26609924	241
	48	HITRONIC® HVN-Mini500 4x12 E9/125 OS2	26609948	241										
	72	HITRONIC® HVN-Mini500 6x12 E9/125 OS2	26609972	241										
	96	HITRONIC® HVN-Mini1000 8x12 E9/125 OS2	26609996	241										
	144	HITRONIC® HVN-Mini1000 12x12 E9/125 OS2	26609944	241										
	Armoured Outdoor Cable A-DQ(ZN)(SR)2Y (loose tube, 4 – 24 fibres)	Outdoor	static	Multimode 50/125 µm OM3	4	3000	PE	compact, central loose tube, metallic armoured (corrugated steel tape), higher mechanical and chemical resistance, excellent rodent protection, halogen-free, UV resistance, moisture protected, watertight, low friction	HITRONIC® HQW3000 4 G 50/125 OM3	27900304	242			
					8				HITRONIC® HQW3000 8 G 50/125 OM3	27900308	242			
					12				HITRONIC® HQW3000 12 G 50/125 OM3	27900312	242			
					24				HITRONIC® HQW3000 24 G 50/125 OM3	27900324	242			
				Multimode 50/125 µm OM2	4	3000	PE	compact, central loose tube, metallic armoured (corrugated steel tape), higher mechanical and chemical resistance, excellent rodent protection, halogen-free, UV resistance, moisture protected, watertight, low friction	HITRONIC® HQW3000 4 G 50/125 OM2	27900204	242			
					8				HITRONIC® HQW3000 8 G 50/125 OM2	27900208	242			
					12				HITRONIC® HQW3000 12 G 50/125 OM2	27900212	242			
					24				HITRONIC® HQW3000 24 G 50/125 OM2	27900224	242			
				Multimode 62.5/125 µm OM1	4	3000	PE	compact, central loose tube, metallic armoured (corrugated steel tape), higher mechanical and chemical resistance, excellent rodent protection, halogen-free, UV resistance, moisture protected, watertight, low friction	HITRONIC® HQW3000 4 G 62.5/125 OM1	27900104	242			
					8				HITRONIC® HQW3000 8 G 62.5/125 OM1	27900108	242			
					12				HITRONIC® HQW3000 12 G 62.5/125 OM1	27900112	242			
					24				HITRONIC® HQW3000 24 G 62.5/125 OM1	27900124	242			
				Singlemode 9/125 µm OS2	4	3000	PE	compact, central loose tube, metallic armoured (corrugated steel tape), higher mechanical and chemical resistance, excellent rodent protection, halogen-free, UV resistance, moisture protected, watertight, low friction	HITRONIC® HQW3000 4 E 9/125 OS2	27900904	242			
					8				HITRONIC® HQW3000 8 E 9/125 OS2	27900908	242			
					12				HITRONIC® HQW3000 12 E 9/125 OS2	27900912	242			
					24				HITRONIC® HQW3000 24 E 9/125 OS2	27900924	242			

See continuation page 205

Please see detailed technical information on the data sheet ([www.lappgroup.com/products](http://www.lappgroup.com/products)). Multimode OM4 fibres are also available upon request for all GOF cables.

## Quickfinder (continuation)

FO-fibre type	Cable type/standardisation (DIN VDE 0888)	Area of Installation	Cabling	Fibre Specification	No. of fibres	Max. tensile force (long-term) in [N]	Outer sheath material	Product Benefits	Article designation	Article number	Page		
GOF – Glass Optical Fibre	Universal Cable A/J-DQ(ZN)BH U-DQ(ZN)BH (loose tube, 4 – 24 fibres)	Indoor/Outdoor	static	Multimode 50/125 µm OM3	4	1500	LSZH	compact, flexible, central loose tube, flame retardant, low smoke emission, UV resistance, halogen-free, rodent and moisture protection, watertight	HITRONIC® HUN1500 4 G 50/125 OM3	27400304	246		
					8				HITRONIC® HUN1500 8 G 50/125 OM3	27400308	246		
					12				HITRONIC® HUN1500 12 G 50/125 OM3	27400312	246		
					24				HITRONIC® HUN1500 24 G 50/125 OM3	27400324	246		
				Multimode 50/125 µm OM2	4	1500	LSZH	compact, flexible, central loose tube, flame retardant, low smoke emission, UV resistance, halogen-free, rodent and moisture protection, watertight	HITRONIC® HUN1500 4 G 50/125 OM2	27400204	246		
					8				HITRONIC® HUN1500 8 G 50/125 OM2	27400208	246		
					12				HITRONIC® HUN1500 12 G 50/125 OM2	27400212	246		
					24				HITRONIC® HUN1500 24 G 50/125 OM2	27400224	246		
				Multimode 62.5/125 µm OM1	4	1500	LSZH	compact, flexible, central loose tube, flame retardant, low smoke emission, UV resistance, halogen-free, rodent and moisture protection, watertight	HITRONIC® HUN1500 4 G 62.5/125 OM1	27400104	246		
					8				HITRONIC® HUN1500 8 G 62.5/125 OM1	27400108	246		
					12				HITRONIC® HUN1500 12 G 62.5/125 OM1	27400112	246		
					24				HITRONIC® HUN1500 24 G 62.5/125 OM1	27400124	246		
	Singlemode 9/125 µm OS2	4	1500	LSZH	compact, flexible, central loose tube, flame retardant, low smoke emission, UV resistance, halogen-free, rodent and moisture protection, watertight	HITRONIC® HUN1500 4 E 9/125 OS2	27400904	246					
		8				HITRONIC® HUN1500 8 E 9/125 OS2	27400908	246					
		12				HITRONIC® HUN1500 12 E 9/125 OS2	27400912	246					
		24				HITRONIC® HUN1500 24 E 9/125 OS2	27400924	246					
	Armoured Universal Cable A/J-DQ(ZN)(SR)BH U-DQ(ZN)(SR)BH (loose tube, 4 – 24 fibres)	Indoor/Outdoor	static	Multimode 50/125 µm OM3	4	1500	LSZH	metallic armoured (corrugated steel tape), excellent rodent protection, flame retardant, low smoke emission, halogen-free, moisture protection, watertight	HITRONIC® HUW1500 4 G 50/125 OM3	27500304	247		
					8				HITRONIC® HUW1500 8 G 50/125 OM3	27500308	247		
					12				HITRONIC® HUW1500 12 G 50/125 OM3	27500312	247		
					24				HITRONIC® HUW1500 24 G 50/125 OM3	27500324	247		
				Multimode 50/125 µm OM2	4	1500	LSZH	metallic armoured (corrugated steel tape), excellent rodent protection, flame retardant, low smoke emission, halogen-free, moisture protection, watertight	HITRONIC® HUW1500 4 G 50/125 OM2	27500204	247		
					8				HITRONIC® HUW1500 8 G 50/125 OM2	27500208	247		
					12				HITRONIC® HUW1500 12 G 50/125 OM2	27500212	247		
					24				HITRONIC® HUW1500 24 G 50/125 OM2	27500224	247		
				Multimode 62.5/125 µm OM1	4	1500	LSZH	metallic armoured (corrugated steel tape), excellent rodent protection, flame retardant, low smoke emission, halogen-free, moisture protection, watertight	HITRONIC® HUW1500 4 G 62.5/125 OM1	27500104	247		
					8				HITRONIC® HUW1500 8 G 62.5/125 OM1	27500108	247		
					12				HITRONIC® HUW1500 12 G 62.5/125 OM1	27500112	247		
					24				HITRONIC® HUW1500 24 G 62.5/125 OM1	27500124	247		
		Singlemode 9/125 µm OS2	4	1500	LSZH	metallic armoured (corrugated steel tape), excellent rodent protection, flame retardant, low smoke emission, halogen-free, moisture protection, watertight	HITRONIC® HUW1500 4 E 9/125 OS2	27500904	247				
			8				HITRONIC® HUW1500 8 E 9/125 OS2	27500908	247				
			12				HITRONIC® HUW1500 12 E 9/125 OS2	27500912	247				
			24				HITRONIC® HUW1500 24 E 9/125 OS2	27500924	247				
		GOF – Glass Optical Fibre	Breakout Cable J-V(ZN)HH (tight buffer, 2 – 12 fibres)	Indoor	static	Multimode 50/125 µm OM4	2	400	LSZH	halogen-free, flame-retardant, low smoke emission, easy to handle, highly flexible, suitable for direct connector assembly, SIMPLEX sheath diameter: 2.1 mm	HITRONIC® HRH400 2 G 50/125 OM4	26000402	248
							4	600			HITRONIC® HRH600 4 G 50/125 OM4	26000404	248
							8	1200			HITRONIC® HRH1200 8 G 50/125 OM4	26000408	248
							12	1700			HITRONIC® HRH1700 12 G 50/125 OM4	26000412	248
Multimode 50/125 µm OM3						2	400	LSZH	halogen-free, flame-retardant, low smoke emission, easy to handle, highly flexible, suitable for direct connector assembly, SIMPLEX sheath diameter: 2.1 mm	HITRONIC® HRH400 2 G 50/125 OM3	26000302	248	
						4	600			HITRONIC® HRH600 4 G 50/125 OM3	26000304	248	
						8	1200			HITRONIC® HRH1200 8 G 50/125 OM3	26000308	248	
						12	1700			HITRONIC® HRH1700 12 G 50/125 OM3	26000312	248	
Multimode 50/125 µm OM2	2					400	LSZH	halogen-free, flame-retardant, low smoke emission, easy to handle, highly flexible, suitable for direct connector assembly, SIMPLEX sheath diameter: 2.1 mm	HITRONIC® HRH400 2 G 50/125 OM2	26000202	248		
	4					600			HITRONIC® HRH600 4 G 50/125 OM2	26000204	248		
	8					1200			HITRONIC® HRH1200 8 G 50/125 OM2	26000208	248		
	12					1700			HITRONIC® HRH1700 12 G 50/125 OM2	26000212	248		
Multimode 62.5/125 µm OM1	2		400	LSZH	halogen-free, flame-retardant, low smoke emission, easy to handle, highly flexible, suitable for direct connector assembly, SIMPLEX sheath diameter: 2.1 mm	HITRONIC® HRH400 2 G 62.5/125 OM1	26000102	248					
	4		600			HITRONIC® HRH600 4 G 62.5/125 OM1	26000104	248					
	8		1200			HITRONIC® HRH1200 8 G 62.5/125 OM1	26000108	248					
	12		1700			HITRONIC® HRH1700 12 G 62.5/125 OM1	26000112	248					

See continuation page 207

Please see detailed technical information on the data sheet ([www.lappgroup.com/products](http://www.lappgroup.com/products)). Multimode OM4 fibres are also available upon request for all GOF cables.

## Quickfinder (continuation)

FO-fibre type	Cable type/standardisation (DIN VDE 0888)	Area of Installation	Cabling	Fibre Specification	No. of fibres	Max. tensile force (long-term) in [N]	Outer sheath material	Product Benefits	Article designation	Article number	Page
GOF – Glass Optical Fibre	Breakout Cable J-V(ZN)HH (tight buffer, 2 – 12 fibres)	Indoor	static	Singlemode 9/125 µm OS2	2	400	LSZH	halogen-free, flame-retardant, low smoke emission, easy to handle, highly flexible, suitable for direct connector assembly, SIMPLEX sheath diameter: 2.1 mm	HITRONIC® HRH400 2 E9/125 OS2	26000902	248
					4	600			HITRONIC® HRH600 4 E9/125 OS2	26000904	248
					8	1200			HITRONIC® HRH1200 8 E9/125 OS2	26000908	248
					12	1700			HITRONIC® HRH1700 12 E9/125 OS2	26000912	248
	Mini Breakout Cable J-V(ZN)H (tight buffer, 2 – 12 fibres)	Indoor	static	Multimode 50/125 µm OM4	2	650	LSZH	halogen-free, flame-retardant, low smoke emission, easy to handle, suitable for direct connector assembly, tight buffer fibre diameter: 900µm	HITRONIC® HDH 2 G 50/125 OM4	26010402	249
					4				HITRONIC® HDH 4 G 50/125 OM4	26010404	249
					8	850			HITRONIC® HDH 8 G 50/125 OM4	26010408	249
					12				HITRONIC® HDH 12 G 50/125 OM4	26010412	249
				Multimode 50/125 µm OM3	2	650	LSZH	halogen-free, flame-retardant, low smoke emission, easy to handle, suitable for direct connector assembly, tight buffer fibre diameter: 900µm	HITRONIC® HDH 2 G 50/125 OM3	26010302	249
					4				HITRONIC® HDH 4 G 50/125 OM3	26010304	249
					8	850			HITRONIC® HDH 8 G 50/125 OM3	26010308	249
					12				HITRONIC® HDH 12 G 50/125 OM3	26010312	249
				Multimode 50/125 µm OM2	2	650	LSZH	halogen-free, flame-retardant, low smoke emission, easy to handle, suitable for direct connector assembly, tight buffer fibre diameter: 900µm	HITRONIC® HDH 2 G 50/125 OM2	26010202	249
					4				HITRONIC® HDH 4 G 50/125 OM2	26010204	249
					8	850			HITRONIC® HDH 8 G 50/125 OM2	26010208	249
					12				HITRONIC® HDH 12 G 50/125 OM2	26010212	249
				Multimode 62.5/125 µm OM1	2	650	LSZH	halogen-free, flame-retardant, low smoke emission, easy to handle, suitable for direct connector assembly, tight buffer fibre diameter: 900µm	HITRONIC® HDH 2 G 62.5/125 OM1	26010102	249
					4				HITRONIC® HDH 4 G 62.5/125 OM1	26010104	249
					8	850			HITRONIC® HDH 8 G 62.5/125 OM1	26010108	249
					12				HITRONIC® HDH 12 G 62.5/125 OM1	26010112	249
GOF – Glass Optical Fibre Cables for Special Applications	Fire-Resistant Cable Universal cable with special properties in case of fire A/J-DQ(ZN)BH(SR)H, U-DQ(ZN)BH(SR)H, armoured loose tube cable (4 – 24 fibres)	Universal (indoor and outdoor), safety area, tunnels	static	Multimode 50/125 µm OM3	4	1500	LSZH	Safety fire-resistant fibre optical cable with system integrity for 180 min, halogen-free, flame-retardant, low smoke emission cable sheath, metallic armoured (corrugated steel tape)	HITRONIC® FIRE 4G50/125 OM3	27560304	235
					8				HITRONIC® FIRE 8G50/125 OM3	27560308	235
					12				HITRONIC® FIRE 12G50/125 OM3	27560312	235
					24				HITRONIC® FIRE 24G50/125 OM3	27560324	235
				Multimode 50/125 µm OM2	4	1500	LSZH	Safety fire-resistant fibre optical cable with system integrity for 180 min, halogen-free, flame-retardant, low smoke emission cable sheath, metallic armoured (corrugated steel tape)	HITRONIC® FIRE 4G50/125 OM2	27560204	235
					8				HITRONIC® FIRE 8G50/125 OM2	27560208	235
					12				HITRONIC® FIRE 12G50/125 OM2	27560212	235
					24				HITRONIC® FIRE 24G50/125 OM2	27560224	235
				Multimode 62.5/125 µm OM2	4	1500	LSZH	Safety fire-resistant fibre optical cable with system integrity for 180 min, halogen-free, flame-retardant, low smoke emission cable sheath, metallic armoured (corrugated steel tape)	HITRONIC® FIRE 4G62,5/125 OM1	27560104	235
					8				HITRONIC® FIRE 8G62,5/125 OM1	27560108	235
					12				HITRONIC® FIRE 12G62,5/125 OM1	27560112	235
					24				HITRONIC® FIRE 24G62,5/125 OM1	27560124	235
				Singlemode 9/125 µm OS2	4	1500	LSZH	Safety fire-resistant fibre optical cable with system integrity for 180 min, halogen-free, flame-retardant, low smoke emission cable sheath, metallic armoured (corrugated steel tape)	HITRONIC® FIRE 4E9/125 OS2	27560904	235
					8				HITRONIC® FIRE 8E9/125 OS2	27560908	235
					12				HITRONIC® FIRE 12E9/125 OS2	27560912	235
					24				HITRONIC® FIRE 24E9/125 OS2	27560924	235
	Torsion-Resistant Breakout Cable A/J-V(ZN)H11Y flexible (tight buffer, 2 – 12 fibres)	Universal (indoor and outdoor), Torsion, flexible application	flexible (Torsion)	Multimode 50/125 µm OM2	2	600	PUR	Fibre optical cables for wind applications with defined movement, torsion with robust PUR sheath, breakout cable construction, SIMPLEX sheath diameter: 2.5 mm	HITRONIC® TORSION 2G50/125 OM2	26310202	236
					4	800			HITRONIC® TORSION 4G50/125 OM2	26310204	236
					8	1600			HITRONIC® TORSION 8G50/125 OM2	26310208	236
					12	2400			HITRONIC® TORSION 12G50/125 OM2	26310212	236
Multimode 62.5/125 µm OM1				2	600	PUR	Fibre optical cables for wind applications with defined movement, torsion with robust PUR sheath, breakout cable construction, SIMPLEX sheath diameter: 2.5 mm	HITRONIC® TORSION 2G62,5/125 OM1	26310102	236	
				4	800			HITRONIC® TORSION 4G62,5/125 OM1	26310104	236	
				8	1600			HITRONIC® TORSION 8G62,5/125 OM1	26310108	236	
				12	2400			HITRONIC® TORSION 12G62,5/125 OM1	26310112	236	

See continuation page 209

Please see detailed technical information on the data sheet ([www.lappgroup.com/products](http://www.lappgroup.com/products)). Multimode OM4 fibres are also available upon request for all GOF cables.



## Quickfinder (continuation)

FO-fibre type	Cable type/standardisation (DIN VDE 0888)	Area of Installation	Cabling	Fibre Specification	No. of fibres	Max. tensile force (long-term) in [N]	Outer sheath material	Product Benefits	Article designation	Article number	Page
GOF – Glass Optical Fibre Cables for Special Applications	highly flexible drag chain Breakout cable A/J-V(ZN)H(ZN)11Y (tight buffer, 2 – 12 fibres)	Universal, industrial area	flexible, moving (drag chain)	Multimode 50/125 µm OM4	4	1000	PUR	Fibre optical cable for flexible applications (power chain) for high mechanical stress in industrial environments, PUR outer sheath, breakout cable construction, SIMPLEX sheath dimension: 2.0 mm	HITRONIC® HRM-FD1000 4G50/125 OM4	26300404	238
				Multimode 50/125 µm OM3					HITRONIC® HRM-FD1000 4G50/125 OM3	26300304	238
				Multimode 50/125 µm OM2					HITRONIC® HRM-FD1000 4G50/125 OM2	26300204	238
				Multimode 62,5/125 µm OM1					HITRONIC® HRM-FD1000 4G62,5/125 OM1	26300104	238
				Singlemode 9/125 µm OS2					HITRONIC® HRM-FD1000 4E9/125 OS2	26300904	238
	Reelable Mini Breakout Cable A/ J-V(ZN)11Y flexible (tight buffer, 4, 6, 8 fibres)	Universal, industrial area, event technology	flexible (for frequent reeling)	Multimode 50/125 µm OM4	4	600	PUR	Reelable fibre optical cable for events and plant engineering, tactical applications, with robust PUR outer sheath, mini-Breakout cable construction, tight buffer fibre diameter: 900µm	HITRONIC® HDM600 4G50/125 OM4	26610404	237
					6				HITRONIC® HDM600 6G50/125 OM4	26610406	237
					8				HITRONIC® HDM700 8G50/125 OM4	26610408	237
				Multimode 50/125 µm OM3	4	600	PUR	Reelable fibre optical cable for events and plant engineering, tactical applications, with robust PUR outer sheath, mini-Breakout cable construction, tight buffer fibre diameter: 900µm	HITRONIC® HDM600 4G50/125 OM3	26610304	237
					6				HITRONIC® HDM600 6G50/125 OM3	26610306	237
					8				HITRONIC® HDM700 8G50/125 OM3	26610308	237
				Multimode 50/125 µm OM2	4	600	PUR	Reelable fibre optical cable for events and plant engineering, tactical applications, with robust PUR outer sheath, mini-Breakout cable construction, tight buffer fibre diameter: 900µm	HITRONIC® HDM600 4G50/125 OM2	26610204	237
					6				HITRONIC® HDM600 6G50/125 OM2	26610206	237
					8				HITRONIC® HDM700 8G50/125 OM2	26610208	237
				Multimode 62.5/125 µm OM1	4	600	PUR	Reelable fibre optical cable for events and plant engineering, tactical applications, with robust PUR outer sheath, mini-Breakout cable construction, tight buffer fibre diameter: 900µm	HITRONIC® HDM600 4G62.5/124 OM1	26610104	237
					6				HITRONIC® HDM600 6G62.5/125 OM1	26610106	237
					8				HITRONIC® HDM700 8G62.5/125 OM1	26610108	237

FO-fibre type	Cable type/standardisation (DIN VDE 0888)	Area of Installation	Cabling	Fibre Specification	No. of fibres	Outer sheath material	Product Benefits	Article designation	Article number	Page
POF – Polymer Optical Fibre	J-V2Y 1P980/1000	Indoor (industrial & automation areas)	static	POF 980/1000 µm	1 (SIMPLEX)	PE	fibre sheath halogen-free, non-ageing, direct connector assembly	HITRONIC® POF SIMPLEX PE	28000001	219
	J-V2Y(ZN)11Y 1P980/1000				1 (SIMPLEX)	PUR	PUR outer sheath halogen-free, flame-retardant, direct connector assembly	HITRONIC® POF SIMPLEX PE-PUR	28020001	220
	J-V2Y 2P980/1000				2 (DUPLICATE)	PE	fibre sheath halogen-free, non-ageing, direct connector assembly	HITRONIC® POF DUPLICATE PE	28000002	222
	J-V2Y(ZN)11Y 2P980/1000				2 (DUPLICATE)	PUR	PUR outer sheath halogen-free, flame-retardant, direct connector assembly	HITRONIC® POF DUPLICATE PE-PUR	28020002	222
	J-V2Y(ZN)11Y 2P980/1000				2 (DUPLICATE)		thicker outer sheath for increased mechanical resistance, halogen-free	HITRONIC® POF DUPLICATE HEAVY PE-PUR	28030002	222
	J-V2Y(ZN)11Y 1P980/1000 flex				highly flexible	1 (SIMPLEX)	PUR	power chain, for highly flexible industrial applications, halogen-free outer sheath	HITRONIC® POF SIMPLEX FD PE-PUR	28320001
	J-V2Y(ZN)11Y 2P980/1000 flex	2 (DUPLICATE)	PUR	power chain, for highly flexible industrial applications, halogen-free outer sheath		HITRONIC® POF DUPLICATE FD PE-PUR	28320002	221		
	J-V4Y(ZN)11Y 2P980/1000	Industry and automation PROFINET®	static, Type B	POF 980/1000 µm	2 (DUPLICATE)	PUR	PROFINET® compliant Type B, PA fibre buffer, PUR outer sheath, halogen-free, for high mechanical or chemical stress in industrial environments	HITRONIC® POF DUPLICATE PNB PA-PUR	28051002	223
	J-V4Y(ZN)Y 2P980/1000				2 (DUPLICATE)	PVC	PROFINET® compliant Type B, PA fibre buffer, PVC outer sheath, for standard applications in industrial environments	HITRONIC® POF DUPLICATE PNB PA-PVC	28052002	223
J-V4Y(ZN)11Y 2P980/1000 flex	2 (DUPLICATE)				PUR	PROFINET® compliant Type C, PA fibre buffer, PUR outer sheath, halogen-free, for flexible applications (power chain)	HITRONIC® POF DUPLICATE FD PNC PA-PUR	28351002	223	

PCF – Polymer Cladded Fibre	A-V(ZN)11Y 1K200/230	Outdoor	static	PCF 200/230 µm	1 (SIMPLEX)	PUR	PUR outer sheath, flame-retardant and halogen-free outer sheath, for direct connector assembly	HITRONIC® PCF SIMPLEX PUR Outdoor	28600701	229	
	AT-VQ(ZN)HB2Y 2K200/230				2 (DUPLICATE)	PE	compatible with all typical BUS systems, FRNC SIMPLEX sheath (diameter: 2.9 mm), PE outer sheath, low-smoke and halogen-free outer sheath, for direct connector assembly	HITRONIC® PCF DUPLICATE FRNC-PE Outdoor	28620702	230	
	J-V(ZN)H11Y 2K200/230	Indoor	static	PCF 200/230 µm	2 (DUPLICATE)	PUR	compatible with all typical BUS systems, FRNC SIMPLEX sheath (diameter: 2.9 mm), PUR outer sheath, low-smoke and halogen-free outer sheath, for direct connector assembly	HITRONIC® PCF DUPLICATE FRNC-PUR Indoor	28020702	230	
	A/J-V(ZN)H11Y 2K200/230 flex	Universal	highly flexible	PCF 200/230 µm	2 (DUPLICATE)	PUR	power chain, compatible with all typical BUS systems, for highly flexible industrial applications, FRNC SIMPLEX sheath (diameter: 2.2mm), halogen-free outer sheath, for direct connector assembly	HITRONIC® PCF DUPLICATE FRNC-PUR FD	28320702	231	
	AT-V(ZN)YY 2K200/230	Industry and automation PROFINET®	static, Type B	PCF 200/230 µm	2 (DUPLICATE)	PVC	PROFINET® compliant Type B, PVC SIMPLEX sheath (2.2 mm), PVC outer sheath, for standard applications in industrial environments, for direct connector assembly	HITRONIC® PCF DUPLICATE PNB PVC-PVC	28052702	232	
	AT-V(ZN)YY 2K200/230 (with UL-listing)				2 (DUPLICATE)		PVC	PROFINET® compliant Type B, PVC SIMPLEX sheath (2.2 mm), PVC outer sheath, for standard applications in industrial environments, for direct connector assembly, c(UL)us OFNG 75 °C	HITRONIC® PCF DUPLICATE PNB PVC-PVC A	28055702	232
	AT-V(ZN)Y(ZN)Y 2K200/230 flex				highly flexible, Type C	2 (DUPLICATE)	PVC	PROFINET® compliant Type C, PVC SIMPLEX sheath (2.2 mm), PVC outer sheath, for flexible applications (power chain)	HITRONIC® PCF DUPLICATE FD PNC PVC-PVC	28352702	232
	AT-V(ZN)Y(ZN)11Y 2K200/230 flex					2 (DUPLICATE)	PUR	PROFINET® compliant Type C, PVC SIMPLEX sheath (2.2 mm), PUR outer sheath, halogen-free, for flexible applications (power chain)	HITRONIC® PCF DUPLICATE FD PNC PVC-PUR	28351702	232

Please see detailed technical information on the data sheet ([www.lappgroup.com/products](http://www.lappgroup.com/products)). Multimode OM4 fibres are also available upon request for all GOF cables.

## HITRONIC® Product Overview

Type of fibre	Cables		Connectors and adapters	Accessories
POF	POF SIMPLEX PE			
	POF DUPLEX PE			
	POF SIMPLEX PE-PUR			
	POF DUPLEX PE-PUR			
	POF DUPLEX Heavy			
	POF SIMPLEX FD PE-PUR			
	POF DUPLEX FD PE-PUR			
PCF	PCF SIMPLEX Outdoor			
	PCF DUPLEX Outdoor			
	PCF DUPLEX Indoor			
	PCF DUPLEX FD Universal			
GOF	HITRONIC® FIRE			
	HITRONIC® TORSION			
	HRM-FD Flexible			
	HDM Reel			
	HQN Outdoor			
	HVN Stranded Outdoor			
	HVN-Micro Outdoor			
	HQW Armoured Outdoor			
	HVW Armoured Stranded Outdoor			
	HQW-Plus Armoured Outdoor			
	HQA Aerial ADSS			
	HQA-Plus Aerial ADSS			
	HUN Universal			
	HUW Armoured Universal			
HRH Breakout				
HDH Mini Breakout				

Photographs are not to scale and do not represent detailed images of the respective products.



## POF selection table: connector – cable – tools – accessories

Connector types			ST (BFOC)		FSMA				F05 SIMPLEX	HFBR-Connector Family									
			Crimp version	Clamp version	Crimp version		Clamp version			POF Connector HFBR4501	POF Connector HFBR4503	POF Connector HFBR4506	POF Connector HFBR4511	POF Connector HFBR4513	POF Connector HFBR4516	POF Connector HFBR4531	POF Connector HFBR4532	POF Connector HFBR4533	
			POF Connector ST(BFOC) Crimp 2.2	POF Connector ST(BFOC) Clamp 2.2	POF Connector FSMA Crimp 2.2	POF Connector FSMA Hex Crimp	POF Connector FSMA Clamp 2.2	POF Connector FSMA Hex Clamp	POF Connector F05 SIMPLEX										
			Article no./PU	Article no./PU	Article no./PU		Article no./PU		Article no./PU	Article no./PU									
			29125099/4	29120099/4	29135099/4	29135089/4	29130099/4	29130089/4	29150099/4	29140099/4	29141099/4	29142099/4	29143099/4	29144099/4	29145099/4	29146099/4	29147099/4	29148099/4	
29125098/50	29120098/50	29135098/50	29135088/50	29130098/50	29130088/50	29150098/50	29140098/50	29141098/50	29142098/50	29143098/50	29144098/50	29145098/50	29146098/50	29147098/50	29148098/50				
Cable – tools – accessories			Article no.																
(compatible) Cables	HITRONIC® POF SIMPLEX PE	28000001	X	X	X	X	X	X	X	X	X	X	X	X	X	X	X		
	HITRONIC® POF SIMPLEX PE-PUR	28020001	X	X	X	X	X	X	X	X	X	X	X	X	X	X	X		
	HITRONIC® POF SIMPLEX FD PE-PUR	28320001	X	X	X	X	X	X	X	X	X	X	X	X	X	X	X		
	HITRONIC® POF DUPLEX PE	28000002	X	X	X	X	X	X	X	X	X	X	X	X	X	X	X		
	HITRONIC® POF DUPLEX PE-PUR	28020002	X	X	X	X	X	X	X	X	X	X	X	X	X	X	X		
	HITRONIC® POF DUPLEX HEAVY PE-PUR	28030002	X	X	X	X	X	X	X	X	X	X	X	X	X	X	X		
	HITRONIC® POF DUPLEX FD PE-PUR	28320002	X	X	X	X	X	X	X	X	X	X	X	X	X	X	X		
Tool sets	Assembly Set POF Connector FSMA	29500001			X	X	(X)*	(X)*											
	Assembly Set POF Connector ST(BFOC)	29500002	X	(X)*															
Adapters	POF Adapter FSMA/4PC	29430099			X	X	X	X											
	POF Adapter FSMA Hex/4PC	29430089			X	X	X	X											
	POF Adapter ST (BFOC)/4PC	29420099	X	X															
	POF Adapter F05 SIMPLEX/4PC	29450099							X										
	POF Adapter HFBR4505 GY SIMPLEX/4PC	29440099								X			X						
	POF Adapter HFBR4515 BL SIMPLEX/4PC	29441099								X			X						
Individual accessories, tools, supplies	POF Buffered Fibre Stripper 2.2 mm	29500011	X	X	X	X	X	X	X	X	X	X	X	X	X	X	X		
	POF Cable Stripper 3.6/6.0 mm	29500012	X (for cable)	X (for cable)	X (for cable)	X (for cable)	X (for cable)	X (for cable)	X (for cable)	X (for cable)	X (for cable)	X (for cable)	X (for cable)	X (for cable)	X (for cable)	X (for cable)	X (for cable)		
	POF Cable Stripper PA 2.2 mm	29500013																	
	POF Crimp Tool 2.5/3.0/4.5/4.95 mm	29500010	X		X	X				X	X	X	X	X	X				
	Strain relief element scissors	29500017	X	X	X	X	X	X	X										
	Polishing film graining size 1000 (BL)	29500021	X	X	X	X	X	X	X		X	X	X	X	X				
	Polishing film graining size 0.3 µm (WH)	29500022																	
	Polishing film graining size 1 µm (GN)	29500023	X	X	X	X	X	X	X		X	X	X	X	X				
	Polishing film graining size 5 µm (BR)	29500024	X	X	X	X	X	X	X		X	X	X	X	X				
	Polishing glass plate 150x230 mm	29500020	X	X	X	X	X	X	X										
	Polishing Disc POF ST(BFOC) Connector	29500032	X	X															
	Polishing Disc POF HFBR4501/4511 SIMPLEX	29500033								X		X							
	Polishing Disc POF SIMPLEX 2.2 mm	29500036																	
	Polishing Disc POF FSMA Connector	29500031			X	X	X	X											
	Polishing Disc POF F05 Connector	29500035							X										
	Polishing Disc POF HFBR4516 DUPLEX	29500034												X					
POF Cutter 2.2/1.0 mm Guillotine	29500014	X	X	X	X	X	X	X	X	X	X	X	X	X	X	X			
POF BufferedFibreCutter 2.2 mm manual	29500015	X (Alternative)	X (Alternative)	X (Alternative)	X (Alternative)	X (Alternative)	X (Alternative)	X (Alternative)	X (Alternative)	X (Alternative)	X (Alternative)	X (Alternative)	X (Alternative)	X (Alternative)	X (Alternative)	X (Alternative)			
POF BufferedFibreCutter 2.2 mm automatic	29500016	X (Alternative)	X (Alternative)	X (Alternative)	X (Alternative)	X (Alternative)	X (Alternative)	X (Alternative)	X (Alternative)	X (Alternative)	X (Alternative)	X (Alternative)	X (Alternative)	X (Alternative)	X (Alternative)	X (Alternative)			
Optional test accessories	POF Optical Transmitter (TMR)	29500070	X	X	X	X	X	X	X	X									
	POF Optical TMR Adapter HFBR, 650 nm	29500071								X									
	POF Optical TMR Adapter FSMA, 650 nm	29500072			X	X	X	X											
	POF Optical TMR Adapter ST(BFOC), 650 nm	29500073	X	X															
	POF Optical TMR Adapter F05, 660 nm	29500074							X										
	POF Optical TMR Adapter HFBR, 660 nm	29500075								X									
	POF Optical TMR Adapter FSMA, 660 nm	29500076			X	X	X	X											
	POF Optical TMR Adapter ST(BFOC), 660 nm	29500077	X	X															
	POF Optical Power Meter 660/850 nm	29500080	X		X	X	X	X	X	X									
	POF Power Meter Adapter HFBR4501/4521	29500081								X									
	POF Power Meter Adapter FSMA	29500082			X	X	X	X											
	POF Power Meter Adapter ST(BFOC)	29500083	X	X															
POF Power Meter Adapter F05	29500084							X											
POF Measuring Equipment Set 660/850 nm	29500089	X (Set: Transmitter, Power Meter)	X (Set: Transmitter, Power Meter)	X (Set: Transmitter, Power Meter)	X (Set: Transmitter, Power Meter)	X (Set: Transmitter, Power Meter)	X (Set: Transmitter, Power Meter)	X (Set: Transmitter, Power Meter)	X (Set: Transmitter, Power Meter)	X (Set: Transmitter, Power Meter)									

\* Includes tools that can be used on the clamp version.

## PCF selection table: connector – cable – tools – accessories

Connector types		ST (BFOC)		FSMA		HFBR 4521	
		Clamp version		Clamp version		Clamp version	Crimp version
		PCF Connector ST(BFOC) Clamp 3.0	PCF Connector ST(BFOC) Clamp 2.2	PCF Connector FSMA Clamp 3.0	PCF Connector FSMA Clamp 2.2	PCF Connector HFBR4521 Clamp 3.0	PCF Connector HFBR4521 BK SIMPLEX 2.2
		Article no./PU		Article no./PU		Article no./PU	
Cable – tools – accessories		29126799/4	29125799/4	29136799/4	29135799/4	29141799/4	29140799/4
		29126798/50	29125798/50	29136798/50	29135798/50	29141798/50	29140798/50
Article no.							
(compatible) Cables	HITRONIC® PCF SIMPLEX PUR, 2.9 mm	28600701	X		X	X	
	HITRONIC® PCF DUPLEX FRNC-PUR, 2.9 mm	28020702	X		X	X	
	HITRONIC® PCF DUPLEX FRNC-PE, 2.9 mm	28620702	X		X	X	
	HITRONIC® PCF DUPLEX FD FRNC-PUR, 2.2 mm	28320702		X		X	X
Tool sets	Assembly Set PCF Connector FSMA	29500701			X	X	
	Assembly Set PCF Connector ST(BFOC)	29500702	X	X			
	Assembly Set PCF Connector HFBR4521	29500703				X	
Adapters	POF Adapter FSMA/4PC	29430099			X	X	
	POF Adapter FSMA Hex/4PC	29430089			X	X	
	POF Adapter ST (BFOC)/4PC	29420099	X	X			
	POF Adapter F05 SIMPLEX/4PC	29450099					
	POF Adapter HFBR4505 GY SIMPLEX/4PC	29440099					
	POF Adapter HFBR4515 BL SIMPLEX/4PC	29441099					
Individual accessories, tools, supplies	PCF Buffered Fibre Stripper 0.5 mm (K200/230)	29500711	X	X	X	X	X
	POF Cable Stripper 3.6/6.0 mm	29500012	X	X	X	X	X
	POF Cable Stripper PA 2.2 mm	29500013					
	POF Crimp Tool 2.5/3.0/4.5/4.95 mm	29500010					
	PCF Cleaving Tool FSMA Connector	29500712			X	X	
	PCF Cleaving Tool ST(BFOC) Connector	29500713	X	X			
	PCF Cleaving Tool HFBR4521 Connector	29500714					X
	Strain relief element scissors	29500017	X	X	X	X	X
	PCF Microscope Adapter FSMA SIMPLEX	29500771			X	X	
	PCF Microscope Adapter ST(BFOC) SIMPLEX	29500772	X	X			
	PCF Microscope Adapter HFBR SIMPLEX	29500773					X
	PCF Inspection Microscope (100x)	29500770	X	X	X	X	X
	Polishing film graining size 1000 (BL)	29500021					
	Polishing film graining size 0.3 µm (WH)	29500022	X (optional)	X (optional)	X (optional)	X (optional)	X (optional)
	Polishing film graining size 1 µm (GN)	29500023	X (optional)	X (optional)	X (optional)	X (optional)	X (optional)
	Polishing film graining size 5 µm (BR)	29500024	X (optional)	X (optional)	X (optional)	X (optional)	X (optional)
	Polishing glass plate 150x230 mm	29500020	X (optional)	X (optional)	X (optional)	X (optional)	X (optional)
	Polishing Disc POF ST(BFOC) Connector	29500032					
	Polishing Disc POF HFBR4501/4511 SIMPLEX	29500033					
	Polishing Disc POF SIMPLEX 2.2 mm	29500036					
	Polishing Disc POF FSMA Connector	29500031					
	Polishing Disc POF F05 Connector	29500035					
	Polishing Disc POF HFBR4516 DUPLEX	29500034					
Polishing Disc PCF HFBR4521 Connector	29500733					X	
Optional test accessories	POF Optical Transmitter (TMR)	29500070	X	X	X	X	X
	POF Optical TMR Adapter HFBR, 650 nm	29500071					
	POF Optical TMR Adapter FSMA, 650 nm	29500072			X	X	
	POF Optical TMR Adapter ST(BFOC), 650 nm	29500073	X	X			
	POF Optical TMR Adapter F05, 660 nm	29500074					
	POF Optical TMR Adapter HFBR, 660 nm	29500075					X
	POF Optical TMR Adapter FSMA, 660 nm	29500076			X	X	
	POF Optical TMR Adapter ST(BFOC), 660 nm	29500077	X	X			
	POF Optical Power Meter 660/850 nm	29500080	X	X	X	X	X
	POF Power Meter Adapter HFBR4501/4521	29500081					X
	POF Power Meter Adapter FSMA	29500082			X	X	
	POF Power Meter Adapter ST(BFOC)	29500083	X	X			
	POF Power Meter Adapter F05	29500084					
POF Measuring Equipment Set 660/850 nm	29500089	X	X	X	X	X	

## Selection criteria

### Basic information needed to select cable

#### 1. Where is it used?

- Indoor
- Outdoor
- Indoor/Outdoor (Universal)

#### 2. Type of applications

- Mining
- Railway
- Wind Turbines
- Inside Machines
- Production or Processing Plants
- Telecommunications
- Power chains
- Vertical installation
- Oil & gas platforms
- On ships

#### 3. Type of Fibres

- GOF Single-mode 9/125 µm OS2
- Multimode 62.5/125 µm OM1
- Multimode 50/125 µm OM2
- Multimode 50/125 µm OM3
- Multimode 50/125 µm OM4
- PCF (200/230)
- POF (980/1000)

#### 4. No. of Fibres

- GOF 2, 4, 6, 8, 12, 24 ... n x 12 (depend on cable type)
- POF 1 (SIMPLEX), 2 (DUPLEX)
- PCF 1 (SIMPLEX), 2 (DUPLEX)

### Cable designations for optical cables according to DIN VDE 0888

□ – □ □ □ □ □ □  
1 2 3 4 5 6

#### 1. Product application area

- A Outdoor cable
- AT Outdoor cable, divisible
- J Indoor cable
- U or A/J Universal cable (for outdoor and indoor)

#### 2. Buffered fibre type

- B Loose tube, unfilled
- D Loose tube, filled
- V Tight-buffered fibre

#### 3. Cable construction

(in the cable from inside to outside)

- B Armouring
- F Grease-filled
- Q Swelling tape, dry core
- (L) Aluminium tape
- S Optical cable with copper elements
- (SR) Corrugated steel tape
- (ZN) Non-metallic strain relief elements
- (ZS) metallic strain relief elements

#### 4. Sheath materials

- H Halogen-free sheath
- Y PVC sheath
- 2Y PE sheath
- 4Y PA sheath
- 11Y PUR sheath

#### 5. Number of fibres

- X Number of fibres or number of loose tubes X numbers of fibres per loose tube

#### 6. Fibre type/fibre dimensions

- E Single-mode fibre (glass core/glass cladding) 9/125 µm SM GOF (OS2)
- G Multimode fibre (glass core/glass cladding) 50/125 µm or 62.5/125 µm MM GOF (OM1, OM2, OM3, OM4)
- K Plastic clad fibre (glass core/plastic cladding) 200/230 µm PCF
- P Polymer optical fibre (polymer core/polymer cladding) 980/1000 µm POF

#### 7. Optical quality/transmission properties

#### Example 1: A-DQ(ZN)(SR)2Y 12G 50/125 OM3

Outdoor cable with corrugated steel tape armour and PE sheath, central loose tube, non-metallic strain relief made of glass yarns, 12 fibres, 50/125 µm OM3 multimode fibres

#### Example 2: J-V2Y(ZN)11Y 2P 980/1000

Plastic fibre-optic cable, two-fibre (DUPLEX), indoor cable with PE inner sheath, non-metallic strain relief, PUR outer sheath

### Article number coding for cables (not applicable to accessories)

□ □ □ □ □ □ □ □ □ □  
A B C D1 D2

#### A. Group of fibres

- 6 GOF cables
- 7 GOF cables
- 8 POF/PCF cables

#### B. Installation area

- 0 Indoor
- 3 Universal, flexible
- 4 Universal
- 5 Universal, armoured
- 6 Outdoor
- 9 Outdoor, armoured

#### C. Type of fibres

- 0 POF 980/1000
- 1 GOF 62.5/125 OM1
- 2 GOF 50/125 OM2
- 3 GOF 50/125 OM3
- 4 GOF 50/125 OM4
- 7 PCF 200/230
- 9 GOF 9/125 OS2 (ITU-G652.D)

#### D. No. of fibres

- 01 SIMPLEX, 1 fibre
- 02 DUPLEX, 2 fibres
- 04 4 fibres
- 08 8 fibres
- 12 12 fibres
- 24 24 fibres
- 96 96 fibres
- 44 144 fibres

Example 1:  
GOF outdoor cable,  
**HQN1500 24G 50/125 OM3 27600324**

Example 2:  
GOF armoured universal cable,  
**HUW1500 8E 9/125 OS2 27500908**

Example 3:  
POF cable,  
**POF SIMPLEX PE 28000001**

Example 4:  
POF cable,  
**POF DUPLEX PE-PUR 28020002**

Example 5:  
PCF outdoor cable,  
**PCF SIMPLEX Outdoor 28600701**

Example 6:  
PCF indoor cable,  
**PCF DUPLEX Indoor 28020702**

## Fibre Optic – Transmission Overview

### Advantages of Fibre Optical Cables

- high resistance to tapping
- no EMC interference
- no EMC testing required
- long transmission range
- no potential transfer
- no cross-talk
- little space required
- low cable weight
- can be installed in a potentially explosive environment

### 10 Gbit/s Data Systems – OM3 (and OM4)

- Conventional OM2 multi-mode fibres:  
82 m transmission length
- OM3 multi-mode fibres: 300 m
- OM4 multi-mode: 550 m

**Note:**

- Special processes in manufacturing the cores
- OM3 cables are backward compatible with OM2 equipment (and vice versa)
- Advantage is only applicable at 850 nm

### GOF – Glass Optical Fibre

**A distinction is drawn between GOF:**

- Singlemode Fibre SM 9 µm
- Multimode Fibre MM 50 µm or 62.5 µm

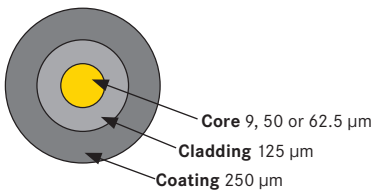

### POF – Polymer Optical Fibre

**A distinction is drawn between POF:**

- SIMPLEX (one fibre)
- DUPLEX (two fibres)

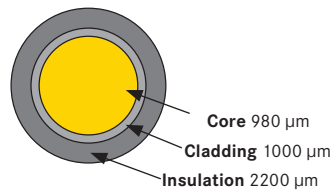

### PCF – Plastic Cladded Fibre

**Note:**

PCF is also known as HCS (Hard Cladded Silica Optical Fibre)

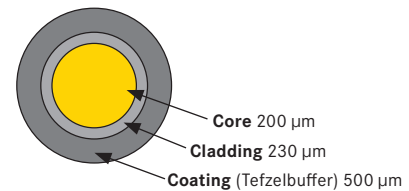

Cabled fibre type	max. attenuation [dB/km]				max. transmission length [m]				colour
	660 nm	850 nm	1300 nm	1550 nm	660 nm	850 nm	1300 nm	1550 nm	
POF 980 µm	160				100 Mbit/s: 60				
PCF 200 µm	10.0	8.0			100 Mbit/s: 550				
GOF MM 62.5 µm OM1		3.5 (3.0)	1.5 (0.7)			100 Mbit/s: 550 1 Gbit/s: 275 10 Gbit/s: 33	100 Mbit/s: 2000 1 Gbit/s: 550 10 Gbit/s: 300		Orange
GOF MM 50 µm OM2		3.5 (2.5)	1.5 (0.7)			100 Mbit/s: 550 1 Gbit/s: 550 10 Gbit/s: 82	100 Mbit/s: 2.000 1 Gbit/s: 550 10 Gbit/s: 300		Orange
GOF MM 50 µm OM3		3.5 (2.5)	1.5 (0.7)			1 Gbit/s: 1.000 10 Gbit/s: 300 40 Gbit/s: 100 100 Gbit/s: 100	1 Gbit/s: 550 10 Gbit/s: 300		Aqua
GOF MM 50 µm OM4		3.5 (2.5)	1.5 (0.7)			1 Gbit/s: 1.100 10 Gbit/s: 550 40 Gbit/s: 150 100 Gbit/s: 150	1Gbit/s: 550 10 Gbit/s: 300		Violet
GOF SM 9 µm OS2 (G652.D)			0.40 (0.35)	0.40 (0.21)			1 Gbit/s: 5.000 10 Gbit/s: 10.000	1 Gbit/s: 80.000 10 Gbit/s: 40.000	Yellow



### HITRONIC® ARMOUR SWA

Fibre optic cable with steel wire armouring (SWA)

**Benefits**

- High mechanical protection against accidental impacts
- Excellent rodent protection
- Suitable for direct burial
- UV and water-resistant

**Application range**

- Heavy industrial areas
- For indoor or outdoor use
- Methods of deployment: empty plastic pipes, ducts and trays



### HITRONIC® ARMOUR SWA LEAD

Fibre optic cable with extruded lead armouring for chemical protection

**Benefits**

- Protection against hydrocarbons and other chemicals
- Excellent rodent protection
- High mechanical protection against accidental impacts

**Application range**

- Harsh oil and chemical environments
- Heavy industrial areas
- For direct burial, especially in the presence of oil and aggressive chemical substances



### HITRONIC® ARMOUR SWA AL/HDPE/PA

Fibre optic cable with aluminum tape and additional HDPE and PA sheaths for water and chemical protection

**Benefits**

- Aluminum tape acts as a barrier to prevent water penetration
- Cost-effective protection against hydrocarbons and other aggressive chemicals (EN 50288-7)
- High mechanical protection

**Application range**

- Harsh oil and chemical environments
- Heavy industrial areas
- For direct burial, especially in the presence of oil and aggressive chemical substances

**Technical data**

**Fibre**  
 Core/Cladding material: Glass/Glass  
 Type of fibre: Singlemode 9/ 125 OS2;  
 Multimode 50/ 125 OM4, 50/ 125 OM3,  
 50/ 125 OM2, and 62.5/ 125 OM1  
 No. of fibres: 4-144

**Temperature range**  
 -40 °C to + 70 °C

**Tensile force (maximum)**  
 3000 N

Inner and outer sheath materials are based on the area of installation:  
 ● For outdoors, PE or PVC is used  
 ● For indoor use, where flame retardance is required, LSZH material is used

Similar armouring can also be added to other cables, e.g. ETHERLINE® ARMOUR, UNITRONIC® ARMOUR

## LAPP SYSTEMS

### Two different connection types are used with fibre optic cables:

1. Detachable connections realised with plug connectors. In this case it is necessary to attach a plug to a glass fibre. This calls for trained personnel and expensive special tools.
2. Non-detachable connections created by directly splicing two glass fibres together. To do this requires highly trained personnel and very expensive equipment. If the necessary resources are used only occasionally, the investment is very unlikely to pay for itself.

**Advantages**

- Using a trunk system offers you the following advantages:
- No costs for special equipment
  - No need for highly trained personnel
  - Uniform quality due to manufacturing under laboratory conditions
  - Installation is quick, thereby saving costs
  - No need to carry out measurements on the cable run, as it comes with OTDR test certificate
  - Fan-out elements also available in IP67

### The answer: The Lapp fibre trunk system.

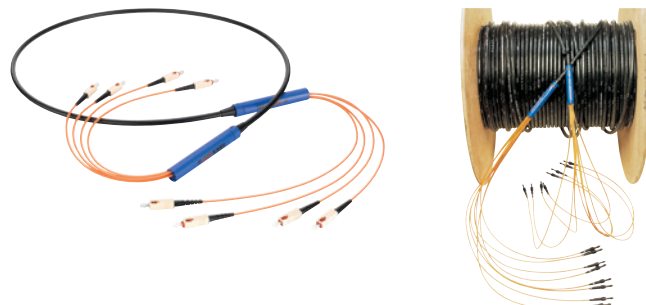

**Requirements**

- The following data are needed to produce your tailor-made trunk system:
- Length of cable run (effective run +3 to 5 metres reserve on either side)
  - Fibre type (SM 9 µm, MM 50 µm or 62.5 µm)
  - Number of fibres (2, 4, 6, 8 ... to 48 fibres)
  - Connector type (ST, SC, LC, others on request ... including mixed assemblies)
  - Cable type (indoor, outdoor, rodent protection etc.)
  - Special cable type upon request

Photographs are not to scale and do not represent detailed images of the respective products.

ÖLFLEX® | UNITRONIC® | ETHERLINE® | HITRONIC® | EPIC® | SKINTOP® | FLEXIMARK® | APPENDIX



## HITRONIC® POF SIMPLEX PE

**Info**

- J-V2Y 1P 980/1000
- Simplex polymer fibre-optic cable for direct connector assembly

### Benefits

- Transmission lengths up to 70 m
- Suitable for direct connector assembly
- Easy to handle
- No crosstalk
- EMC protection

### Application range

- For optical signal transmission in industrial applications
- Very suitable for fixed installation in control cabinets, cable ducts, or pipes with low mechanical stress

### Product features

- Lightweight
- High flexibility
- Halogen-free buffer tube

### Design

- Polymer Optical Fibre (POF)
- PE buffer tube
- Without outer sheath
- Colour: black

### Technical data

- Optical fibre type**  
 Core material: PMMA  
 Cladding material: fluoropolymers
- Permissible bending radius**  
 ≥ 10 x outer diameter
- Permissible tensile force**  
 Fixed installation: 5 N  
 Short-term: 15 N
- Temperature range**  
 Operation: -20 °C to +70 °C  
 Installation: -10 °C to +50 °C

Article number	Article designation	Fibre type	Number of fibres	Outer diameter (mm)	Weight (kg/km)
<b>HITRONIC® POF SIMPLEX PE</b>					
28000001	HITRONIC® POF SIMPLEX PE	980/1000 POF	1	2.2	4

Unless specified otherwise, the shown product values are nominal values. Detailed values (e.g. tolerances) are available upon request. Photographs are not to scale and do not represent detailed images of the respective products.

### Similar products

- HITRONIC® POF SIMPLEX PE-PUR refer to page 220

### Accessories

- POF Connector and Adapter HFBR refer to page 224
- POF Cutting Tools refer to page 227
- POF Connector F05 Simplex refer to page 225
- UNIVERSAL STRIP stripping and cutting tool



POF - Polymer Optical Fibre

HITRONIC® POF Simplex Cables



## HITRONIC® POF SIMPLEX PE-PUR



**Info**

- J-V2Y(ZN)11Y 1P 980/1000
- Simplex POF cable with strain relief and PUR outer sheath

**Benefits**

- Transmission lengths up to 70 m
- Suitable for direct connector assembly
- Easy to handle
- No crosstalk
- EMC protection

**Application range**

- For optical signal transmission in industrial applications with high mechanical stress

**Product features**

- Resistant to abrasion, oil, microbes and hydrolysis
- Adhesion-free
- Flame-retardant and halogen-free outer sheath

**Design**

- Polymer Optical Fibre (POF)
- PE buffer tube
- Aramid yarns as strain relief
- PUR outer sheath
- Colour: orange (RAL 2003)

**Technical data**

- Optical fibre type**  
Core material: PMMA  
Cladding material: fluoropolymers
- Permissible bending radius**  
Short-term: 30 mm  
Fixed installation: 50 mm
- Permissible tensile force**  
Fixed installation: 100 N  
Short-term: 350 N
- Temperature range**  
Operation: -20 °C to +70 °C  
Installation: -10 °C to +50 °C

Article number	Article designation	Fibre type	Number of fibres	Outer diameter (mm)	Weight (kg/km)
<b>HITRONIC® POF SIMPLEX PE-PUR</b>					
28020001	HITRONIC® POF SIMPLEX PE-PUR	980/1000 POF	1	5.5	25

Unless specified otherwise, the shown product values are nominal values. Detailed values (e.g. tolerances) are available upon request.  
Please find our standard lengths at: [www.lappkabel.de/en/cable-standardlengths](http://www.lappkabel.de/en/cable-standardlengths)  
Photographs are not to scale and do not represent detailed images of the respective products.

**Accessories**

- POF Assembly Sets refer to page 226
- POF Cutting Tools refer to page 227
- POF Connector F-SMA and ST(BFOC) refer to page 225
- STAR STRIP stripping tool
- SMART STRIP stripping tool

ÖLFLEX®  
 UNITRONIC®  
 ETHERLINE®  
 HITRONIC®  
 EPIC®  
 SKINTOP®  
 FLEXIMARK®  
 APPENDIX



**New**

## HITRONIC® POF FD PE-PUR

LAPP KABEL STUÏTGART HITRONIC® POF DUPLEX FD PE-PUR

LAPP KABEL STUÏTGART HITRONIC® POF SIMPLEX FD PE-PUR



**Info**

- J-V2Y(ZN)11Y
- Flexible POF cable designed for moving applications

**Benefits**

- Designed for use in power chains
- Transmission lengths up to 70 m
- Suitable for direct connector assembly
- Easy to handle
- EMC protection

**Application range**

- For highly flexible applications
- As a link between moving parts
- For optical signal transmission in industrial applications with high mechanical stress

**Product features**

- Highly flexible
- Flame-retardant and halogen-free outer sheath
- Resistant to abrasion, oil, microbes and hydrolysis

**Design**

- Polymer Optical Fibre (POF)
- PE buffer tube
- Aramid yarns as strain relief
- PUR outer sheath
- Colour: orange (RAL 2003)

**Technical data**

- Minimum bending radius**  
Static: ≥ 15 x outer diameter  
Dynamic: ≥ 20 x outer diameter
- Optical fibre type**  
Core material: PMMA  
Cladding material: fluoropolymers
- Permissible tensile force**  
Fixed installation: 100 N  
Short-term: 400 N
- Temperature range**  
Operation: -20 °C to +70 °C  
Installation: -10 °C to +50 °C

Article number	Article designation	Fibre type	Number of fibres	Outer diameter (mm)	Weight (kg/km)
<b>SIMPLEX</b>					
28320001	HITRONIC® POF SIMPLEX FD PE-PUR	980/1000 POF	1	6	32
<b>DUPLEX</b>					
28320002	HITRONIC® POF DUPLEX FD PE-PUR	980/1000 POF	2	6	31

Unless specified otherwise, the shown product values are nominal values. Detailed values (e.g. tolerances) are available upon request.  
Please find our standard lengths at: [www.lappkabel.de/en/cable-standardlengths](http://www.lappkabel.de/en/cable-standardlengths)  
Photographs are not to scale and do not represent detailed images of the respective products.

**Accessories**

- POF Assembly Sets refer to page 226
- POF Cutting Tools refer to page 227
- SILVYN® CHAIN
- STAR STRIP stripping tool
- SMART STRIP stripping tool

ÖLFLEX®

UNITRONIC®

ETHERLINE®

HITRONIC®

EPIC®

SKINTOP®

FLEXIMARK®

APPENDIX

POF - Polymer Optical Fibre

HITRONIC® POF Duplex Cables



## HITRONIC® POF DUPLEX PE

**Benefits**

- Transmission lengths up to 70 m
- Suitable for direct connector assembly
- Easy to handle
- No crosstalk
- EMC protection

**Application range**

- For optical signal transmission in industrial applications
- Very suitable for fixed installation in control cabinets, cable ducts, or pipes with low mechanical stress
- Light mechanical stress
- Identification by white dots

**Product features**

- Halogen-free
- Lightweight
- High flexibility

**Design**

- Polymer Optical Fibre (POF)
- Twin cable
- PE buffer tube
- Without outer sheath
- Colour: black



**Info**

- J-V2Y 2x1P 980/1000
- Duplex polymer fibre-optic cable for direct connector assembly

**Technical data**

- Optical fibre type**  
Core material: PMMA  
Cladding material: fluoropolymers
- Permissible bending radius**  
≥ 10 x outer diameter
- Permissible tensile force**  
Fixed installation: 10 N  
Short-term: 30 N
- Temperature range**  
Operation: -20 °C to +70 °C  
Installation: -10 °C to +50 °C

Article number	Article designation	Fibre type	Number of fibres	Weight (kg/km)
<b>HITRONIC® POF DUPLEX PE</b>				
28000002	HITRONIC® POF DUPLEX PE	980/1000 POF	2	7.6

Unless specified otherwise, the shown product values are nominal values. Detailed values (e.g. tolerances) are available upon request. Please find our standard lengths at: [www.lappkabel.de/en/cable-standardlengths](http://www.lappkabel.de/en/cable-standardlengths)  
Photographs are not to scale and do not represent detailed images of the respective products.

**Similar products**

- HITRONIC® POF SIMPLEX PE refer to page 219

**Accessories**

- POF Connector and Adapter HFBR refer to page 224
- POF Cutting Tools refer to page 227
- UNIVERSAL STRIP stripping and cutting tool



## HITRONIC® POF DUPLEX PE-PUR



**Benefits**

- EMC protection
- Transmission lengths up to 70 m
- Suitable for direct connector assembly
- Easy to handle
- No crosstalk

**Application range**

- For optical signal transmission in industrial applications with high mechanical stress

**Product features**

- Flame-retardant and halogen-free outer sheath
- Resistant to abrasion, oil, microbes and hydrolysis
- Adhesion-free

**Design**

- Polymer Optical Fibre (POF)
- PE buffer tube
- Fibre colour coding: black, orange
- Aramid yarns as strain relief
- PUR outer sheath, orange (RAL 2003)



**Info**

- J-V2Y(ZN)11Y 2P 980/1000
- Duplex plastic fibre optic cable with strain relief and PUR outer sheath

**Technical data**

- Optical fibre type**  
Core material: PMMA  
Cladding material: fluoropolymers
- Permissible bending radius**  
Static: ≥ 30 mm (PE-PUR), ≥ 50 mm (Heavy PE-PUR)  
Dynamic: ≥ 50 mm (PE-PUR), ≥ 80 mm (Heavy PE-PUR)
- Permissible tensile force**  
Fixed installation: 100 N (PE-PUR), 130 N (Heavy PE-PUR)  
Short-term: 400 N
- Temperature range**  
Operation: -40 °C to +70 °C  
Installation: -10 °C to +50 °C

Article number	Article designation	Fibre type	Number of fibres	Outer diameter (mm)	Weight (kg/km)
<b>HITRONIC® POF DUPLEX PE-PUR</b>					
28020002	HITRONIC® POF DUPLEX PE-PUR	980/1000 POF	2	5.5	27
28030002	HITRONIC® POF DUPLEX HEAVY PE-PUR	980/1000 POF	2	8	63

Unless specified otherwise, the shown product values are nominal values. Detailed values (e.g. tolerances) are available upon request. Please find our standard lengths at: [www.lappkabel.de/en/cable-standardlengths](http://www.lappkabel.de/en/cable-standardlengths)  
Photographs are not to scale and do not represent detailed images of the respective products.

**Accessories**

- POF Assembly Sets refer to page 226
- POF Cutting Tools refer to page 227
- POF Connector F-SMA and ST(BFOC) refer to page 225
- STAR STRIP stripping tool



**New**

## HITRONIC® POF cables for PROFINET Applications

**Info**

- PROFINET compliant - Type B or Type C



**Benefits**

- Optical data transmission up to 70m
- Easy to handle
- No interference by external fields
- No grounding problems
- Suitable for direct connector assembly

**Application range**

- For optical signal transmission in industrial applications
- PROFINET / Industrial Ethernet
- At 100 Mbit/s: max 50 m cable length
- PROFINET type B: for fixed laying
- PROFINET type C: for flexible applications (power chains)

**Product features**

- Cable version with PVC outer sheath: for standard applications in industrial environments
- Cable version with PUR outer sheath: for high mechanical or chemical stress in industrial environments
- PNB - PROFINET-Type B
- PNC - PROFINET-Type C
- FD - Highly flexible (power chains)

**Design**

- Polymer Optical Fibre (POF)
- PA buffer tube
- Fibre colour coding: black, orange (with arrow printing)
- Aramid yarns as strain relief
- Outer sheath material PUR or PVC (see article description)
- Outer sheath colour: green (RAL 6018)

**Technical data**

- Dimensions**  
Buffered fibre: 2.2mm  
Cable: see table
- Core identification code**  
Black, orange (with arrow printing)
- Optical fibre type**  
Core material: PMMA  
Cladding material: fluoropolymers
- Permissible bending radius**  
≥ 10 x outer diameter
- Permissible tensile force**  
see data sheet
- Temperature range**  
Operation: -20 °C to +70 °C  
Installation: -10°C to +50°C

Article number	Article designation	Fibre type	Number of fibres	Outer diameter (mm)	Weight (kg/km)
<b>POF DUPLEX - PROFINET TYPE B</b>					
28051002	HITRONIC® POF DUPLEX PNB PA-PUR	980/1000 POF	2	8	54
28052002	HITRONIC® POF DUPLEX PNB PA-PVC	980/1000 POF	2	7.8	59
<b>POF DUPLEX - PROFINET TYPE C</b>					
28351002	HITRONIC® POF DUPLEX FD PNC PA-PUR	980/1000 POF	2	7.2	59

Unless specified otherwise, the shown product values are nominal values. Detailed values (e.g. tolerances) are available upon request.  
 Please find our standard lengths at: [www.lappkabel.de/en/cable-standardlengths](http://www.lappkabel.de/en/cable-standardlengths)  
 Lapp Kabel is a member of the PROFIBUS user organisation (PNO)  
 Photographs are not to scale and do not represent detailed images of the respective products.

**Accessories**

- POF Assembly Sets refer to page 226
- POF Cutting Tools refer to page 227
- POF Connector F-SMA and ST(BFOC) refer to page 225
- EPIC® Data PROFIBUS Connector (Optical Link Modul) refer to page 75
- STAR STRIP stripping tool

New

## POF Connector and Adapter HFBR



### Benefits

- Compatible with HP Versatile Link Connectors and Components series
- Different colours for channel coding

### Application range

- Factory automation
- Medical equipment
- Telecommunications Switching Systems
- Automotive Networks
- Printed Circuit Board

### Product features

- HFBR connector series for 2.2 mm POF
- For crimping or clamping
- Simplex or Duplex variations

Article number	Article designation	PU
<b>Connector HFBR-4501, Simplex, with Crimp Sleeve</b>		
29140099	POF Connector HFBR4501 GY Simplex /4PC	4 piece
29140098	POF Connector HFBR4501 GY Simplex /50PC	50 piece
<b>Latching Connector HFBR-4503, Simplex, with Crimp Sleeve</b>		
29141099	POF Connector HFBR4503 GY Simplex /4PC	4 piece
29141098	POF Connector HFBR4503 GY Simplex /50PC	50 piece
<b>Connector HFBR-4506, Duplex, with Crimp Sleeve</b>		
29142099	POF Connector HFBR4506 WH Duplex /4PC	4 piece
29142098	POF Connector HFBR4506 WH Duplex /50PC	50 piece
<b>Connector HFBR-4511, Simplex, with Crimp Sleeve</b>		
29143099	POF Connector HFBR4511 BL Simplex /4PC	4 piece
29143098	POF Connector HFBR4511 BL Simplex /50PC	50 piece
<b>Latching Connector HFBR-4513, Simplex, with Crimp Sleeve</b>		
29144099	POF Connector HFBR4513 BL Simplex /4PC	4 piece
29144098	POF Connector HFBR4513 BL Simplex /50PC	50 piece
<b>Latching Connector HFBR-4516, Duplex, with Crimp Sleeve</b>		
29145099	POF Connector HFBR4516 GY Duplex /4PC	4 piece
29145098	POF Connector HFBR4516 GY Duplex /50PC	50 piece
<b>Clamp Connector HFBR-4531, Simplex</b>		
29146099	POF Connector HFBR4531 BK Simplex /4PC	4 piece
29146098	POF Connector HFBR4531 BK Simplex /50PC	50 piece
<b>Clamp and Latching Connector HFBR-4532, Simplex</b>		
29147099	POF Connector HFBR4532 BK Simplex /4PC	4 piece
29147098	POF Connector HFBR4532 BK Simplex /50PC	50 piece
<b>Clamp Connector HFBR-4533, Simplex</b>		
29148099	POF Connector HFBR4533 BL Simplex /4PC	4 piece
29148098	POF Connector HFBR4533 BL Simplex /50PC	50 piece
<b>HFBR4505 Adapters</b>		
29440099	POF Adapter HFBR4505 GY Simplex /4PC	4 piece
<b>HFBR4515 Adapters</b>		
29441099	POF Adapter HFBR4515 BL Simplex /4PC	4 piece

Photographs are not to scale and do not represent detailed images of the respective products.

### Accessories

- POF Cutting Tools refer to page 227
- POF Polishing tools and accessories refer to page 227



**New**

## POF Connector F05 Simplex

### Benefits

- Easy to assemble

### Application range

- Digital audio
- Factory automation
- Office Automation (Smart House)

### Product features

- F-05 (TOCP) SIMPLEX clamp connector for connecting to polymer optical fibre without crimping or gluing
- Snap-In Connector
- Suitable for 2.2 mm POF



Info

- Compatible with TOCP155K



Article number	Article designation	PU
<b>Connector F05 Simplex</b>		
29150099	POF Connector F05 Simplex /4PC	4 piece
29150098	POF Connector F05 Simplex /50PC	50 piece
<b>Adapter for Connector F05 Simplex</b>		
29450099	POF Adapter F05 Simplex /4PC	4 piece

Photographs are not to scale and do not represent detailed images of the respective products.

### Accessories

- POF Cutting Tools refer to page 227
- POF Polishing tools and accessories refer to page 227

**New**

## POF Connector F-SMA and ST(BFOC)

### Benefits

- As crimp or clamp version for easy assembling

### Product features

- FSMA and ST(BFOC) connector with knurled nut or hexagonal nut for crimping, gluing or easy clamping
- Suitable for 2.2 mm POF
- Available for different cable diameters (2.2 mm and 6.0 mm)
- Connector including bend protection boot and dust cap
- Bend protection boot colour: black and red



Info

- FSMA and ST(BFOC) connectors for POF cable assembly

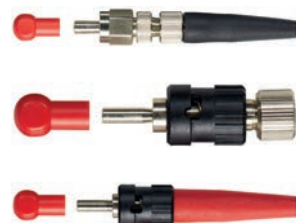

Article number	Article designation	PU
<b>FSMA Connectors with knurled nut for crimping</b>		
29135099	POF Connector FSMA Crimp 2.2 /4PC	4 piece
29135098	POF Connector FSMA Crimp 2.2 /50PC	50 piece
29137099	POF Connector FSMA Crimp 6.0 /4PC	4 piece
29137098	POF Connector FSMA Crimp 6.0 /50PC	50 piece
<b>FSMA Connectors with hexagonal nut for crimping</b>		
29135089	POF Connector FSMA Hex Crimp 2.2 /4PC	4 piece
29135088	POF Connector FSMA Hex Crimp 2.2 /50PC	50 piece
29132089	POF Connector FSMA Hex Crimp 6.0 /4PC	4 piece
29132088	POF Connector FSMA Hex Crimp 6.0 /50PC	50 piece
<b>FSMA Connectors with knurled nut for clamping</b>		
29130099	POF Connector FSMA Clamp 2.2 /4PC	4 piece
29130098	POF Connector FSMA Clamp 2.2 /50PC	50 piece
<b>FSMA Connectors with hexagonal nut for clamping</b>		
29130089	POF Connector FSMA Hex Clamp 2.2 /4PC	4 piece
29130088	POF Connector FSMA Hex Clamp 2.2 /50PC	50 piece
<b>ST(BFOC) Connectors for crimping</b>		
29125099	POF Connector ST(BFOC) Crimp 2.2 /4PC	4 piece
29125098	POF Connector ST(BFOC) Crimp 2.2 /50PC	50 piece
<b>ST(BFOC) Connectors for clamping</b>		
29120099	POF Connector ST(BFOC) Clamp 2.2 /4PC	4 piece
29120098	POF Connector ST(BFOC) Clamp 2.2 /50PC	50 piece

Photographs are not to scale and do not represent detailed images of the respective products.

### Accessories

- POF Assembly Sets refer to page 226
- POF Cutting Tools refer to page 227
- POF Polishing tools and accessories refer to page 227
- POF Measurement Equipment refer to page 228

New

### POF Adapter F-SMA



**Product features**

- POF Adapter FSMA: version with two fixing nuts and lock washer
- POF Adapter FSMA hexa: version with hexagonal flange, fixing nuts and lock washer



**Info**

- Can be used for POF and PCF connector types

Article number	Article designation	PU
<b>FSMA Adapters</b>		
29430099	POF Adapter FSMA /4PC	4 piece
29430089	POF Adapter FSMA Hex /4PC	4 piece

Photographs are not to scale and do not represent detailed images of the respective products.

New

### POF Adapter ST (BFOC)



**Product features**

- ST(BFOC) adapter with flange, fixing nuts and lock washer



**Info**

- Can be used for POF and PCF connector types

Article number	Article designation	PU
<b>ST(BFOC) Adapters</b>		
29420099	POF Adapter ST (BFOC) /4PC	4 piece

Photographs are not to scale and do not represent detailed images of the respective products.

New

### POF Assembly Sets



**Benefits**

- Easy to handle
- Set includes all the necessary tools for connector assembly
- Suitable for on-site assembly

**Product features**

- Sets available for POF connector types FSMA and ST (BFOC)
- Contents: crimp tool, buffered fibre stripper, polishing disc FSMA, polishing film, cutter

Article number	Article designation	PU
<b>Assembly Set for POF FSMA Connector</b>		
29500001	Assembly Set POF Connector FSMA	1 piece
<b>Assembly Set for POF ST(BFOC) Connector</b>		
29500002	Assembly Set POF Connector ST(BFOC)	1 piece

Photographs are not to scale and do not represent detailed images of the respective products.

**New**

**POF Cutting Tools**



**Benefits**

- Cutting tools for the POF cable and connector product range

**Application range**

- Cable stripper for different jacket materials and cable diameter

**Product features**

- Various tools for cutting buffered fibres (2.2mm) from very simple to version with automatic blade advance
- Crimping tool suitable for the POF(PCF) connector program

Article number	Article designation	PU
<b>POF Bare Fibre Cutter</b>		
29500014	POF Cutter 2.2/1.0mm Guillotine	5 pieces
29500015	POF BufferedFibreCutter 2.2mm manuel	1 piece
29500016	POF BufferedFibreCutter 2.2mm automatic	1 piece
<b>POF Cable Stripper</b>		
29500011	POF Buffered Fibre Stripper 2.2 mm (P980/1000)	1 piece
29500013	POF Cable Stripper PA 2.2mm	1 piece
29500012	POF Cable Stripper 3.6/6.0mm	1 piece
<b>Strain relief element scissors</b>		
29500017	Strain relief element scissors	1 piece
<b>POF Crimping Tool</b>		
29500010	POF Crimp Tool 2.5/3.0/4.5/4.95mm	1 piece

Photographs are not to scale and do not represent detailed images of the respective products.

**Similar products**

- POF Assembly Sets refer to page 226

**New**

**POF Polishing tools and accessories**



**Benefits**

- Easy to handle
- Suitable to POF Connector Assembly Sets

**Product features**

- Accessories for POF Assembly
- Polishing disc for various POF connector types
- Other versions are available upon request

- Polishing film with different graining size types for fibre end face treatment
- Polishing process:  
POF - Polishing Film 1000 (BU)  
Polishing Film 5µm (BN)  
Polishing Film 1µm (GN)  
PCF - Polishing Film 5 µm (BN)  
Polishing Film 1 µm (GN)  
Polishing Film 0.3 µm (WH)

Article number	Article designation	PU
<b>Polishing Disc for POF connector assembly</b>		
29500031	Polishing Disc POF FSMA Connector	1 piece
29500032	Polishing Disc POF ST(BFOC) Connector	1 piece
29500033	Polishing Disc POF HFBR4501/4511 SIMPLEX	1 piece
29500034	Polishing Disc POF HFBR4516 DUPLEX	1 piece
29500035	Polishing Disc POF F05 Connector	1 piece
29500036	Polishing Disc POF Simplex 2.2mm	1 piece
29500733	Polishing Disc PCF HFBR4521 Connector	1 piece
<b>Polishing film</b>		
29500021	Polishing film graining size 1000 (BL)	10 pieces
29500024	Polishing film graining size 5 µm (BR)	10 pieces
29500023	Polishing film graining size 1 µm (GN)	10 pieces
29500022	Polishing film graining size 0.3 µm (WH)	10 pieces
<b>Polishing accessories</b>		
29500020	Polishing glass plate 150x230mm	1 piece

Photographs are not to scale and do not represent detailed images of the respective products.

**Similar products**

- POF Assembly Sets refer to page 226

New

## POF Measurement Equipment



### Benefits

- Measuring Equipment Set for wavelenghts 660/850nm
- Suitable for the measurement of assembled POF and PCF systems
- Measuring Equipment Set for different wave lengths and connector types. Connector type and wavelength is defined by interchangeable adapter system

### Product features

- The mesasurement device is supplied without adaters. Please order separatly
- Optical Transmitter (TMR): wavelength dependent on interchangeable adapter
  - 650nm
  - 660nm
  - 850nm (on request)
- Optical Power Meter: for attenuation measurement of an assembled POF (PCF) systems adapted to Optical Transmitter (TMR)

Article number	Article designation	PU
<b>POF Measurement Equipment</b>		
29500070	POF Optical Transmitter (TMR)	1 piece
<b>POF TMR Adapter, wavelength 650nm</b>		
29500071	POF Optical TMR Adapter HFBR, 650nm	1 piece
29500072	POF Optical TMR Adapter FSMA, 650nm	1 piece
29500073	POF Optical TMR Adapter ST(BFOC), 650nm	1 piece
<b>POF TMR Adapter, wavelength 660nm</b>		
29500074	POF Optical TMR Adapter F05, 660nm	1 piece
29500075	POF Optical TMR Adapter HFBR, 660nm	1 piece
29500076	POF Optical TMR Adapter FSMA, 660nm	1 piece
29500077	POF Optical TMR Adapter ST(BFOC), 660nm	1 piece
<b>POF Optical Power Meter 660/850 nm</b>		
29500080	POF Optical Power Meter 660/850 nm	1 piece
<b>POF Power Meter Adapters</b>		
29500081	POF Power Meter Adapter HFBR4501/4521	1 piece
29500082	POF Power Meter Adapter FSMA	1 piece
29500083	POF Power Meter Adapter ST(BFOC)	1 piece
29500084	POF Power Meter Adapter F05	1 piece
<b>POF Measuring Equipment Set without adapters</b>		
29500089	POF Measuring Equipment Set 660/850nm	1 piece

Photographs are not to scale and do not represent detailed images of the respective products.



## HITRONIC® PCF SIMPLEX Cable



**Info**

- A-V(ZN) 11Y
- Simplex plastic cladded fibre (PCF) cable for direct connector assembly

### Benefits

- Transmission lengths up to 500 m
- Suitable for direct connector assembly
- High mechanical strength
- UV-resistant
- EMC protection

### Application range

- For data transmission in field bus systems, such as PROFIBUS, INTERBUS etc.
- Industrial environments





### Product features

- Possible transmission wavelengths: 650 nm and 850 nm
- Flame-retardant and halogen-free outer sheath

### Design

- Tight-buffered fibres
- Aramid yarns as strain relief
- PUR outer sheath
- Colour: black (RAL 9005)

### Technical data

- 
**Minimum bending radius**  
 Static: ≥ 15 x outer diameter  
 Dynamic: ≥ 20 x outer diameter
- 
**Optical fibre type**  
 Core material: glass  
 Cladding material: fluoropolymers
- 
**Permissible tensile force**  
 Fixed installation: 200 N
- 
**Temperature range**  
 Operation: -10°C to +60°C  
 Installation: -10°C to +50°C

Article number	Article designation	Fibre type	Number of fibres	Outer diameter (mm)	Weight (kg/km)
<b>HITRONIC® PCF SIMPLEX Cable</b>					
28600701	HITRONIC® PCF SIMPLEX PUR Outdoor	200/230 PCF	1	2.9	7.5

Unless specified otherwise, the shown product values are nominal values. Detailed values (e.g. tolerances) are available upon request.  
 The cables can also be supplied as pre-terminated fibre optic trunks.  
 Photographs are not to scale and do not represent detailed images of the respective products.

### Accessories

- PCF Assembly Sets refer to page 234
- PCF Connector HFBR refer to page 233
- PCF Connector F-SMA and ST(BFOC) refer to page 233
- PCF Cutting Tools refer to page 234





## HITRONIC® PCF DUPLEX Cable



**Info**

- PCF DUPLEX Indoor: J-V(ZN)H11Y 2K200/230
- PCF DUPLEX Outdoor: A-VQ(ZN)HB2Y 2K200/230
- Plastic-cladded fibre (PCF) cable compatible with all BUS systems

### Benefits

- Transmission lengths up to 500 m
- Suitable for direct connector assembly
- Good resistance to oil, petrol, acids and alkalis
- High mechanical strength
- EMC protection

### Application range

- For data transmission in field bus systems, such as PROFIBUS, INTERBUS etc.
- Industrial environments

### Product features

- Possible transmission wavelengths: 650 nm and 850 nm
- Complies with requirements for all BUS systems
- Halogen-free outer sheath

### Design

- Colour-coded, tight-buffered PCF sub-cable with FRNC sheath (2.9mm)
- Aramid yarns as strain relief
- PUR outer sheath (indoor); PE outer sheath (outdoor)
- Colour: orange (indoor); black (outdoor)

### Technical data

- Minimum bending radius**  
Static:  $\geq 15 \times$  outer diameter  
Dynamic:  $\geq 20 \times$  outer diameter
- Optical fibre type**  
Core material: glass  
Cladding material: fluoropolymers
- Permissible tensile force**  
Fixed installation: 400 N (indoor); 500 N (outdoor)  
Short-term: 1200 N (indoor); 1500 N (outdoor)
- Temperature range**  
Operation:  $-20\text{ }^{\circ}\text{C}$  to  $+70\text{ }^{\circ}\text{C}$   
Installation:  $-10\text{ }^{\circ}\text{C}$  to  $+50\text{ }^{\circ}\text{C}$

Article number	Article designation	Fibre type	Number of fibres	Outer diameter (mm)	Weight (kg/km)
<b>Indoor</b>					
28020702	HITRONIC® PCF DUPLEX FRNC-PUR Indoor	200/230 PCF	2	8	55
<b>Outdoor</b>					
28620702	HITRONIC® PCF DUPLEX FRNC-PE Outdoor	200/230 PCF	2	10.5	90

Unless specified otherwise, the shown product values are nominal values. Detailed values (e.g. tolerances) are available upon request. The cables can also be supplied as pre-terminated fibre optic trunks. Photographs are not to scale and do not represent detailed images of the respective products.

### Similar products

- HITRONIC® PCF DUPLEX FD cables refer to page 231
- HITRONIC® PCF cables for PROFINET Applications refer to page 232

### Accessories

- PCF Assembly Sets refer to page 234
- PCF Connector HFBR refer to page 233
- PCF Connector F-SMA and ST(BFOC) refer to page 233
- STAR STRIP stripping tool
- SMART STRIP stripping tool



**New**

## HITRONIC® PCF DUPLEX FD cables



**Info**

- A/J-V(ZN)H11Y
- Flexible PCF cable compatible with all BUS systems

**Benefits**

- Designed for use in power chains
- Transmission lengths up to 500 m
- Suitable for direct connector assembly
- Good resistance to oil, petrol, acids and alkalis
- EMC protection

**Application range**

- For highly flexible applications
- For data transmission in field bus systems, such as PROFIBUS, INTERBUS etc.
- As a link between moving parts
- Industrial environments

**Product features**

- Possible transmission wavelengths: 650 nm and 850 nm
- Complies with requirements for all BUS systems
- Flame-retardant and halogen-free outer sheath

**Design**

- Colour-coded, tight-buffered PCF sub-cable with FRNC sheath
- Sub cable outer diameter: 2.2mm
- Aramid yarns as strain relief
- PUR outer sheath
- Colour: orange (RAL 2003)

**Technical data**

- Minimum bending radius**  
 Static: ≥ 15 x outer diameter  
 Dynamic: ≥ 20 x outer diameter
- Optical fibre type**  
 Core material: glass  
 Cladding material: fluoropolymers
- Permissible tensile force**  
 Fixed installation: 800 N  
 Short-term: 2000 N
- Temperature range**  
 Operation: -20 °C to +70 °C  
 Installation: -10 °C to +50 °C

Article number	Article designation	Fibre type	Number of fibres	Outer diameter (mm)	Weight (kg/km)
<b>HITRONIC® PCF DUPLEX FD cables</b>					
28320702	HITRONIC® PCF DUPLEX FD FRNC-PUR	200/230 PCF	2	8.8	55

Unless specified otherwise, the shown product values are nominal values. Detailed values (e.g. tolerances) are available upon request.  
 The cables can also be supplied as pre-terminated fibre optic trunks.  
 Photographs are not to scale and do not represent detailed images of the respective products.

**Accessories**

- PCF Assembly Sets refer to page 234
- PCF Connector HFBR refer to page 233
- PCF Connector F-SMA and ST(BFOC) refer to page 233
- PCF Cutting Tools refer to page 234
- STAR STRIP stripping tool

ÖLFLEX®

UNITRONIC®

ETHERLINE®

HITRONIC®

EPIC®

SKINTOP®

FLEXIMARK®

APPENDIX

PCF - Plastic Cladded Fibre

HITRONIC® PCF DUPLEX Cable



New

HITRONIC® PCF cables for PROFINET Applications



**Info**

- PROFINET compliant - Type B or Type C

**Benefits**

- Optical data transmission up to 500m
- Easy to handle
- No interference by external fields
- No grounding problems
- Suitable for direct connector assembly

**Application range**

- PCF DUPLEX cables for optical signal transmission in industrial applications
- PROFINET / Industrial Ethernet
- At 100 Mbit/s: max 100 m cable length
- PROFINET type B: for fixed laying
- PROFINET type C: for flexible applications (power chains)

**Product features**

- Cable version with PVC outer sheath: for standard applications in industrial environments
- Cable version with PUR outer sheath: for high mechanical or chemical stress in industrial environments
- PNB - PROFINET-Type B
- PNC - PROFINET-Type C
- FD - Highly flexible (power chains)

**Norm references / Approvals**

- 28055702: with c(UL)us approval (OFNG 75°C)

**Design**

- Colour-coded, tight-buffered PCF sub-cable with PVC sheath
- Sub cable outer diameter: 2.2mm
- Aramid yarns as strain relief
- Outer sheath material PUR or PVC (see article description)
- Outer sheath colour: green (RAL 6018)

**Technical data**

- Dimensions**  
Sub cable outer diameter: 2.2mm  
Cable: see table
- Core identification code**  
Black, orange (with arrow printing)
- Minimum bending radius**  
see data sheet
- Optical fibre type**  
Core material: glass  
Cladding material: fluoropolymers
- Permissible tensile force**  
see data sheet
- Temperature range**  
See data sheet

Article number	Article designation	Fibre type	Number of fibres	Outer diameter (mm)	Weight (kg/km)
<b>PCF DUPLEX - PROFINET TYPE B</b>					
28055702	HITRONIC® PCF DUPLEX PNB PVC-PVC A	200/230 PCF	2	7.2	59
28052702	HITRONIC® PCF DUPLEX PNB PVC-PVC	200/230 PCF	2	7.2	59
<b>PCF DUPLEX - PROFINET TYPE C</b>					
28351702	HITRONIC® PCF DUPLEX FD PNC PVC-PUR	200/230 PCF	2	8.8	71
28352702	HITRONIC® PCF DUPLEX FD PNC PVC-PVC	200/230 PCF	2	8.8	77

Unless specified otherwise, the shown product values are nominal values. Detailed values (e.g. tolerances) are available upon request.  
Lapp Kabel is a member of the PROFIBUS user organisation (PNO)  
The cables can also be supplied as pre-terminated fibre optic trunks.  
Photographs are not to scale and do not represent detailed images of the respective products.

**Accessories**

- PCF Assembly Sets refer to page 234
- PCF Connector HFBR refer to page 233
- PCF Connector F-SMA and ST(BFOC) refer to page 233
- PCF Cutting Tools refer to page 234
- EPIC® Data PROFIBUS Connector (Optical Link Modul) refer to page 75
- STAR STRIP stripping tool



**New**

## PCF Connector HFBR



### ■ Benefits

- Compatible with HP Versatile Link Connectors and Components series

### ■ Application range

- Factory automation
- Medical equipment
- Telecommunications Switching Systems

### ■ Product features

- HFBR4521 connector for 2.2 mm PCF cable diameter as crimp version
- HFBR4521 connector for 3.0 mm PCF cable diameter as clamp version
- HFBR4521 clamp connector compatible with Assembly Set PCF Connector HFBR4521

Article number	Article designation	PU
<b>Connector HFBR4521 for 2.2 mm cables - crimp version</b>		
29140799	PCF Connector HFBR4521 BK Simplex 2.2 /4PC	4 piece
29140798	PCF Connector HFBR4521 BK Simplex 2.2 /50PC	50 piece
<b>Connector HFBR4521 for 3.0 mm cables - clamp version</b>		
29141799	PCF Connector HFBR4521 Clamp 3.0 /4PC	4 piece
29141798	PCF Connector HFBR4521 Clamp 3.0 /50PC	50 piece

Photographs are not to scale and do not represent detailed images of the respective products.



**New**

## PCF Connector F-SMA and ST(BFOC)



### ■ Benefits

- Easy to assemble
- Designed for field assembly
- Reusable as it can be removed

### ■ Product features

- Connectors for clamp and cleave assembly
- Available for different cable diameters
- Adapters available on request
- Bend protection boot colour: black and red

Article number	Article designation	PU
<b>Connector FSMA Clamp for 3.0 mm cables</b>		
29136799	PCF Connector FSMA Clamp 3.0 /4PC	4 piece
29136798	PCF Connector FSMA Clamp 3.0 /50PC	50 piece
<b>Connector FSMA Clamp for 2.2 mm cables</b>		
29135799	PCF Connector FSMA Clamp 2.2 /4PC	4 piece
29135798	PCF Connector FSMA Clamp 2.2 /50PC	50 piece
<b>Connector ST(BFOC) Clamp for 3.0 mm cables</b>		
29126799	PCF Connector ST (BFOC) Clamp 3.0 /4PC	4 piece
29126798	PCF Connector ST (BFOC) Clamp 3.0 /50PC	50 piece
<b>Connector ST(BFOC) Clamp for 2.2 mm cables</b>		
29125799	PCF Connector ST (BFOC) Clamp 2.2 /4PC	4 piece
29125798	PCF Connector ST (BFOC) Clamp 2.2 /50PC	50 piece

Photographs are not to scale and do not represent detailed images of the respective products.

### ■ Similar products

- POF Adapter F-SMA refer to page 226
- POF Adapter ST (BFOC) refer to page 226

### ■ Accessories

- PCF Assembly kit
- PCF Cutting Tools refer to page 234

New

## PCF Assembly Sets



### Benefits

- Easy to handle
- Set includes all the necessary tools for connector assembly from clamp connector versions
- Suitable for on-site assembly

### Product features

- Sets available for PCF clamp connector types FSMA, ST (BFOC) and HFBR4521
- Contents: stripper, cleave tool, kevlar scissor, cutter, microscope

Article number	Article designation	PU
<b>Assembly Set For PCF Connectors</b>		
29500701	Assembly Set PCF Connector FSMA	1 piece
29500702	Assembly Set PCF Connector ST(BFOC)	1 piece
29500703	Assembly Set PCF Connector HFBR4521	1 piece

Photographs are not to scale and do not represent detailed images of the respective products.

### Accessories

- PCF Connector F-SMA and ST(BFOC) refer to page 233
- PCF Cutting Tools refer to page 234

New

## PCF Cutting Tools



### Benefits

- Optimally coordinated tools for the PCF cable and connector product range
- For the processing of PCF fibres

### Product features

- PCF cleaving tool for connector types: -FSMA -ST(BFOC) -HFBR4521

Article number	Article designation	PU
<b>PCF Buffered Fibre Stripper</b>		
29500711	PCF Buffered Fibre Stripper 0.5mm (K200/230)	1 piece
<b>PCF Fibre Cleving Tool</b>		
29500712	PCF Cleving Tool FSMA Connector	1 piece
29500713	PCF Cleving Tool ST(BFOC) Connector	1 piece
29500714	PCF Cleving Tool HFBR4521 Connector	1 piece

Photographs are not to scale and do not represent detailed images of the respective products.

### Similar products

- PCF Assembly Sets refer to page 234

New

## PCF Measurement Equipment



### Benefits

- Inspection Microscope with 100x magnification for connector inspection
- Easy to handle

### Product features

- Interchangeable adapter for PCF connector types FSMA, ST(BFOC), HFBR
- Interchangeable adapters are not included in microscope, please order separately
- Other adapters available on request

Article number	Article designation	PU
<b>PCF Inspection Microscope (100x) without adapter</b>		
29500770	PCF Inspection Microscope (100x)	1 piece
<b>PCF Microscope Adapter For Connector Types</b>		
29500771	PCF Microscope Adapter FSMA Simplex	1 piece
29500772	PCF Microscope Adapter ST(BFOC) Simplex	1 piece
29500773	PCF Microscope Adapter HFBR Simplex	1 piece

Photographs are not to scale and do not represent detailed images of the respective products.





**New**

**HITRONIC® FIRE**

**Info**

- A/J-DQ(ZN)BH(SR)H or U-DQ(ZN)BH(SR)H
- Fire-resistant for at least 180 minutes in the event of fire

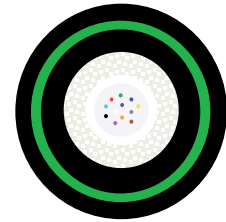

**Benefits**

- Ensures that the fibres can still transmit data during and after a fire (according to IEC 60331-25)
- Suitable for installation in underground tunnels where fire safety is critical
- Additional sheath protects the fibres for use in harsh environments
- Armouring provides excellent protection against high mechanical stress and rodents
- UV-resistant longitudinally and laterally watertight

**Application range**

- In industrial areas that use fire as a tool
- Highly combustible or fire-prone areas
- For indoor and outdoor use
- Methods of Deployment: empty plastic pipes, ducts and trays





**Product features**

- Fire behaviour:
  - Halogen-free (IEC 60754-1)
  - Flame-retardant (IEC 60332-3)
  - Low smoke density (IEC 61034-1/2)
  - Circuit integrity (IEC 60331-25); Optical fibre cables
- Central loose tube with up to 24 fibres
- Colour-coded fibres
- Longitudinal watertight
- Flame-retardant and halogen-free outer sheath

**Design**

- Gel-filled loose tube
- Water-blocking reinforced glass yarn strain relief
- Corrugated steel tape armour
- LSZH inner and outer sheaths
- Colour: black (RAL 9005)

**Technical data**

-  **Optical fibre type**  
Core material: glass  
Cladding material: glass
-  **Permissible bending radius**  
Static: ≥ 15 x outer diameter  
Dynamic: ≥ 20 x outer diameter
-  **Permissible tensile force**  
Fixed installation: 1500 N  
Short-term: 2200 N
-  **Temperature range**  
Fixed installation: -30°C to +70°C

Article number	Article designation	Fibre type	Number of fibres	Outer diameter (mm)	Weight (kg/km)
<b>Multimode G 50 OM3</b>					
27560304	HITRONIC® FIRE 4G 50/125 OM3	50/125 OM3	4	9.8	123
27560308	HITRONIC® FIRE 8G 50/125 OM3	50/125 OM3	8	9.8	123
27560312	HITRONIC® FIRE 12G 50/125 OM3	50/125 OM3	12	12.8	188
27560324	HITRONIC® FIRE 24G 50/125 OM3	50/125 OM3	24	12.8	188
<b>Multimode G 50 OM2</b>					
27560204	HITRONIC® FIRE 4G 50/125 OM2	50/125 OM2	4	9.8	123
27560208	HITRONIC® FIRE 8G 50/125 OM2	50/125 OM2	8	9.8	123
27560212	HITRONIC® FIRE 12G 50/125 OM2	50/125 OM2	12	12.8	188
27560224	HITRONIC® FIRE 24G 50/125 OM2	50/125 OM2	24	12.8	188
<b>Multimode G 62.5 OM1</b>					
27560104	HITRONIC® FIRE 4G 62.5/125 OM1	62.5/125 OM1	4	9.8	123
27560108	HITRONIC® FIRE 8G 62.5/125 OM1	62.5/125 OM1	8	9.8	123
27560112	HITRONIC® FIRE 12G 62.5/125 OM1	62.5/125 OM1	12	12.8	188
27560124	HITRONIC® FIRE 24G 62.5/125 OM1	62.5/125 OM1	24	12.8	188
<b>Single-mode E 9 OS2</b>					
27560904	HITRONIC® FIRE 4E 9/125 OS2	9/125 OS2	4	9.8	123
27560908	HITRONIC® FIRE 8E 9/125 OS2	9/125 OS2	8	9.8	123
27560912	HITRONIC® FIRE 12E 9/125 OS2	9/125 OS2	12	12.8	188
27560924	HITRONIC® FIRE 24E 9/125 OS2	9/125 OS2	24	12.8	188

Unless specified otherwise, the shown product values are nominal values. Detailed values (e.g. tolerances) are available upon request. The cables can also be supplied as pre-terminated fibre optic trunks. Photographs are not to scale and do not represent detailed images of the respective products. Available on request with Multimode OM4 fibres.

**Accessories**

- STAR STRIP stripping tool
- SMART STRIP stripping tool



New

## HITRONIC® TORSION



Info

- A/J-V(ZN)H 11Y
- Breakout cable designed to withstand high torsional stresses
- Torsion-resistant and very flexible

### Benefits

- Designed to withstand high torsion in the windmill drip loop
- Suitable for field assembly
- Easy to install due to the compact design, high flexibility, robust sheath and small bending radii
- Zero electromagnetic interference as the cable contains no metal

### Application range

- For fixed and flexible installations, as well as for applications with torsional movements (e.g. machinery, wind turbines)
- Industrial environments
- In vertical installations
- As a link between moving parts
- For indoor and outdoor use

### Product features

- Based on military norm MIL-C-85045
- Torsion-resistant and very flexible
- Flame-retardant and halogen-free outer sheath
- Mechanically robust

### Design

- 2.5 mm tight-buffered sub-cable with LSZH sheath
- Aramid yarns as strain relief
- Central element
- PUR outer sheath
- Colour: black (RAL 9005)

### Technical data



#### Optical fibre type

Core material: glass  
Cladding material: glass



#### Permissible bending radius

Static: ≥ 15 x outer diameter  
Dynamic: ≥ 20 x outer diameter



#### Temperature range

Fixed installation: -40°C to +70°C  
Occasional flexing: -30°C to +70°C

Article number	Article designation	Fibre type	Number of fibres	Outer diameter (mm)	Weight (kg/km)
<b>Multimode G 50 OM3</b>					
26310302	HITRONIC® TORSION 2G 50/125 OM3	50/125 OM3	2	8.4	54
26310304	HITRONIC® TORSION 4G 50/125 OM3	50/125 OM3	4	8.4	54
26310308	HITRONIC® TORSION 8G 50/125 OM3	50/125 OM3	8	11.6	95
26310312	HITRONIC® TORSION 12G 50/125 OM3	50/125 OM3	12	14.7	122
<b>Multimode G 50 OM2</b>					
26310202	HITRONIC® TORSION 2G 50/125 OM2	50/125 OM2	2	8.4	54
26310204	HITRONIC® TORSION 4G 50/125 OM2	50/125 OM2	4	8.4	54
26310208	HITRONIC® TORSION 8G 50/125 OM2	50/125 OM2	8	11.6	95
26310212	HITRONIC® TORSION 12G 50/125 OM2	50/125 OM2	12	14.7	122
<b>Multimode G 62.5 OM1</b>					
26310102	HITRONIC® TORSION 2G 62.5/125 OM1	62.5/125 OM1	2	8.4	54
26310104	HITRONIC® TORSION 4G 62.5/125 OM1	62.5/125 OM1	4	8.4	54
26310108	HITRONIC® TORSION 8G 62.5/125 OM1	62.5/125 OM1	8	11.6	95
26310112	HITRONIC® TORSION 12G 62.5/125 OM1	62.5/125 OM1	12	14.7	122
<b>Single-mode E 9 OS2</b>					
26310902	HITRONIC® TORSION 2E 9/125 OS2	9/125 OS2	2	8.4	54
26310904	HITRONIC® TORSION 4E 9/125 OS2	9/125 OS2	4	8.4	54
26310908	HITRONIC® TORSION 8E 9/125 OS2	9/125 OS2	8	11.6	95
26310912	HITRONIC® TORSION 12E 9/125 OS2	9/125 OS2	12	14.7	122

Photographs are not to scale and do not represent detailed images of the respective products. Available on request with Multimode OM4 fibres.

### Accessories

- STAR STRIP stripping tool



New

## HITRONIC® HDM Cable

**Info**

- A/J-V(ZN)11Y
- Mini breakout/distribution cable designed for frequent reeling and unreeling use

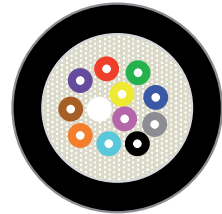

### Benefits

- Designed for use in temporary events' management
- Easy to coil for mobile use
- Very easy to install due to small dimensions, high flexibility, and small bending radius
- Suitable for field assembly
- Zero electromagnetic interference as the cable contains no metal

### Application range

- For flexible applications
- In temporary installations
- Industrial environments
- For indoor and outdoor use

### Product features

- Based on military norm MIL-C-85045
- Highly flexible
- Colour-coded fibres
- Flame-retardant and halogen-free outer sheath
- Mechanically robust

### Design

- Up to 12 tight-buffered fibres (900µm)
- Aramid yarns as strain relief
- PUR outer sheath
- Colour: black (RAL 9005)

### Technical data

- Optical fibre type**  
Core material: glass  
Cladding material: glass
- Permissible bending radius**  
Static: ≥ 15 x outer diameter  
Dynamic: ≥ 20 x outer diameter
- Temperature range**  
Fixed installation: -40°C to +70°C  
Flexible use: -20°C to +60°C

Article number	Article designation	Fibre type	Number of fibres	Outer diameter (mm)	Weight (kg/km)
<b>Multimode G 50 OM4</b>					
26610404	HITRONIC® HDM600 4G 50/125 OM4	50/125 OM4	4	5.5	24
26610406	HITRONIC® HDM600 6G 50/125 OM4	50/125 OM4	6	5.6	29
26610408	HITRONIC® HDM700 8G 50/125 OM4	50/125 OM4	8	6.2	36
<b>Multimode G 50 OM3</b>					
26610304	HITRONIC® HDM600 4G 50/125 OM3	50/125 OM3	4	5.5	24
26610306	HITRONIC® HDM600 6G 50/125 OM3	50/125 OM3	6	5.6	29
26610308	HITRONIC® HDM700 8G 50/125 OM3	50/125 OM3	8	6.2	36
<b>Multimode G 50 OM2</b>					
26610204	HITRONIC® HDM600 4G 50/125 OM2	50/125 OM2	4	5.5	24
26610206	HITRONIC® HDM600 6G 50/125 OM2	50/125 OM2	6	5.6	29
26610208	HITRONIC® HDM700 8G 50/125 OM2	50/125 OM2	8	6.2	36
<b>Multimode G 62.5 OM1</b>					
26610104	HITRONIC® HDM600 4G 62.5/125 OM1	62.5/125 OM1	4	5.5	24
26610106	HITRONIC® HDM600 6G 62.5/125 OM1	62.5/125 OM1	6	5.6	29
26610108	HITRONIC® HDM700 8G 62.5/125 OM1	62.5/125 OM1	8	6.2	36

Unless specified otherwise, the shown product values are nominal values. Detailed values (e.g. tolerances) are available upon request. The cables can also be supplied as pre-terminated fibre optic trunks. Photographs are not to scale and do not represent detailed images of the respective products.



New

## HITRONIC® HRM-FD Cable

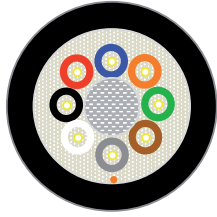

Info

- A/J-V(ZN)H(ZN) 11Y
- Flexible breakout cable designed for use in power chain applications

### Benefits

- Designed for use in power chains
- Suitable for field assembly
- Easy to install due to the compact design, high flexibility, robust sheath and small bending radii
- Zero electromagnetic interference as the cable contains no metal

### Application range

- For highly flexible industrial applications
- As a link between moving parts
- In vertical installations
- Industrial environments
- For indoor and outdoor use

### Product features

- Based on military norm MIL-C-85045
- For use in power chains and moving machinery parts in dry or damp rooms
- Flame-retardant and halogen-free outer sheath
- Mechanically robust

### Design

- 2.0 mm tight-buffered sub-cable with LSZH sheath
- Aramid yarns as strain relief
- Central element
- PUR outer sheath
- Colour: black (RAL 9005)

### Technical data



#### Optical fibre type

Core material: glass  
Cladding material: glass



#### Permissible bending radius

Static:  $\geq 15 \times$  outer diameter  
Dynamic:  $\geq 20 \times$  outer diameter



#### Temperature range

Fixed installation:  $-40^{\circ}\text{C}$  to  $+70^{\circ}\text{C}$   
Flexible use:  $-20^{\circ}\text{C}$  to  $+60^{\circ}\text{C}$

Article number	Article designation	Fibre type	Number of fibres	Outer diameter (mm)	Weight (kg/km)
<b>Multimode G 50 OM4</b>					
26300402	HITRONIC® HRM-FD800 2G 50/125 OM4	50/125 OM4	2	7.8	50
26300404	HITRONIC® HRM-FD1000 4G 50/125 OM4	50/125 OM4	4	7.8	50
26300408	HITRONIC® HRM-FD1400 8G 50/125 OM4	50/125 OM4	8	10.4	93
26300412	HITRONIC® HRM-FD1800 12G 50/125 OM4	50/125 OM4	12	13.0	98
<b>Multimode G 50 OM3</b>					
26300302	HITRONIC® HRM-FD800 2G 50/125 OM3	50/125 OM3	2	7.8	50
26300304	HITRONIC® HRM-FD1000 4G 50/125 OM3	50/125 OM3	4	7.8	50
26300308	HITRONIC® HRM-FD1400 8G 50/125 OM3	50/125 OM3	8	10.4	93
26300312	HITRONIC® HRM-FD1800 12G 50/125 OM3	50/125 OM3	12	13.0	98
<b>Multimode G 50 OM2</b>					
26300202	HITRONIC® HRM-FD800 2G 50/125 OM2	50/125 OM2	2	7.8	50
26300204	HITRONIC® HRM-FD1000 4G 50/125 OM2	50/125 OM2	4	7.8	50
26300208	HITRONIC® HRM-FD1400 8G 50/125 OM2	50/125 OM2	8	10.4	93
26300212	HITRONIC® HRM-FD1800 12G 50/125 OM2	50/125 OM2	12	13.0	98
<b>Multimode G 62.5 OM1</b>					
26300102	HITRONIC® HRM-FD800 2G 62.5/125 OM1	62.5/125 OM1	2	7.8	50
26300104	HITRONIC® HRM-FD1000 4G 62.5/125 OM1	62.5/125 OM1	4	7.8	50
26300108	HITRONIC® HRM-FD1400 8G 62.5/125 OM1	62.5/125 OM1	8	10.4	93
26300112	HITRONIC® HRM-FD1800 12G 62.5/125 OM1	62.5/125 OM1	12	13.0	98
<b>Single-mode E 9 OS2</b>					
26300902	HITRONIC® HRM-FD800 2E 9/125 OS2	9/125 OS2	2	7.8	50
26300904	HITRONIC® HRM-FD1000 4E 9/125 OS2	9/125 OS2	4	7.8	50
26300908	HITRONIC® HRM-FD1400 8E 9/125 OS2	9/125 OS2	8	10.4	93
26300912	HITRONIC® HRM-FD1800 12E 9/125 OS2	9/125 OS2	12	13.0	98

Unless specified otherwise, the shown product values are nominal values. Detailed values (e.g. tolerances) are available upon request. The cables can also be supplied as pre-terminated fibre optic trunks. Photographs are not to scale and do not represent detailed images of the respective products.



## HITRONIC® HQN Outdoor Cable

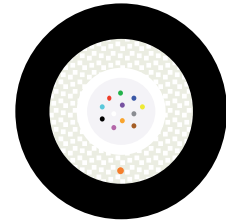

**Info**

- A-DQ(ZN)B2Y
- Outdoor cable with central loose tube and non-metallic strain relief

### Benefits

- Suitable for direct burial
- Easy to install due to the compact design, high flexibility, robust sheath and small bending radii
- UV-resistant longitudinally and laterally watertight
- Zero electromagnetic interference as the cable contains no metal

### Application range

- For outdoor use
- Campus backbone
- WAN applications
- Industrial environments
- Methods of Deployment: empty plastic pipes, ducts and trays

### Product features

- Central loose tube with up to 24 fibres
- Colour-coded fibres
- Longitudinal watertight
- Rodent-protection
- Robust, halogen-free outer sheath

### Design

- Glass fibres with primary coating
- Gel-filled loose tube
- Water-blocking reinforced glass yarn strain relief
- PE outer sheath
- Colour: black (RAL 9005)

### Technical data

- Optical fibre type**  
Core material: glass  
Cladding material: glass
- Permissible bending radius**  
Static: ≥ 15 x outer diameter  
Dynamic: ≥ 20 x outer diameter
- Permissible tensile force**  
Fixed installation: 1500 N  
Short-term: 3000 N
- Temperature range**  
Fixed installation: -40°C to +70°C

Article number	Article designation	Fibre type	Number of fibres	Outer diameter (mm)	Weight (kg/km)
<b>Multimode G 50 OM3</b>					
27600304	HITRONIC® HQN1500 4G 50/125 OM3	50/125 OM3	4	7.3	40
27600308	HITRONIC® HQN1500 8G 50/125 OM3	50/125 OM3	8	7.3	40
27600312	HITRONIC® HQN1500 12G 50/125 OM3	50/125 OM3	12	7.3	40
27600324	HITRONIC® HQN1500 24G 50/125 OM3	50/125 OM3	24	8.3	65
<b>Multimode G 50 OM2</b>					
27600204	HITRONIC® HQN1500 4G 50/125 OM2	50/125 OM2	4	7.3	40
27600208	HITRONIC® HQN1500 8G 50/125 OM2	50/125 OM2	8	7.3	40
27600212	HITRONIC® HQN1500 12G 50/125 OM2	50/125 OM2	12	7.3	40
27600224	HITRONIC® HQN1500 24G 50/125 OM2	50/125 OM2	24	8.3	65
<b>Multimode G 62.5 OM1</b>					
27600104	HITRONIC® HQN1500 4G 62.5/125 OM1	62.5/125 OM1	4	7.3	40
27600108	HITRONIC® HQN1500 8G 62.5/125 OM1	62.5/125 OM1	8	7.3	40
27600112	HITRONIC® HQN1500 12G 62.5/125 OM1	62.5/125 OM1	12	7.3	40
27600124	HITRONIC® HQN1500 24G 62.5/125 OM1	62.5/125 OM1	24	8.3	65
<b>Single-mode E 9 OS2</b>					
27600904	HITRONIC® HQN1500 4E 9/125 OS2	9/125 OS2	4	7.3	40
27600908	HITRONIC® HQN1500 8E 9/125 OS2	9/125 OS2	8	7.3	40
27600912	HITRONIC® HQN1500 12E 9/125 OS2	9/125 OS2	12	7.3	40
27600924	HITRONIC® HQN1500 24E 9/125 OS2	9/125 OS2	24	8.3	65

Unless specified otherwise, the shown product values are nominal values. Detailed values (e.g. tolerances) are available upon request.  
The cables can also be supplied as pre-terminated fibre optic trunks.  
Photographs are not to scale and do not represent detailed images of the respective products.  
Available on request with Multimode OM4 fibres.

### Similar products

- HITRONIC® HUN Universal Cable refer to page 246
- HITRONIC® HVN Outdoor Cable refer to page 240
- HITRONIC® HQW Armoured Outdoor Cable refer to page 242

### Accessories

- GOF SIMPLEX Pigtail refer to page 251
- DATA STRIP stripping tool





## HITRONIC® HVN Outdoor Cable

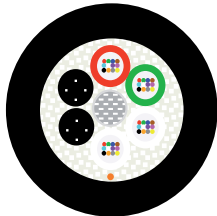

**Info**

- A-DQ(ZN)B2Y
- Outdoor cable with stranded loose tubes and non-metallic strain relief

### Benefits

- Suitable for direct burial
- Easy to install due to the compact design, high flexibility, robust sheath and small bending radii
- UV-resistant longitudinally and laterally watertight
- Zero electromagnetic interference as the cable contains no metal

### Application range

- For outdoor use
- Campus backbone
- WAN applications
- Industrial environments
- Methods of Deployment: empty plastic pipes, ducts and trays

### Product features

- Stranded loose tubes with up to 144 fibres (12 loose tubes with each 12 fibres)
- Colour-coded fibres and loose tubes
- Longitudinal watertight
- Rodent-protection
- Robust, halogen-free outer sheath

### Design

- Up to 12 stranded gel-filled loose tubes
- Central GRP strength element
- Water-blocking reinforced glass yarn strain relief
- PE outer sheath
- Colour: black (RAL 9005)

### Technical data

- Optical fibre type**  
Core material: glass  
Cladding material: glass
- Permissible bending radius**  
Static: ≥ 15 x outer diameter  
Dynamic: ≥ 20 x outer diameter
- Temperature range**  
Fixed installation: -40°C to +70°C

Article number	Article designation	Fibre type	Number of fibres	Outer diameter (mm)	Weight (kg/km)
<b>Multimode G 50 OM3</b>					
26600324	HITRONIC® HVN5000 2x12G 50/125 OM3	50/125 OM3	24	11.0	64
26600348	HITRONIC® HVN5000 4x12G 50/125 OM3	50/125 OM3	48	11.0	84
<b>Multimode G 50 OM2</b>					
26600224	HITRONIC® HVN5000 2x12G 50/125 OM2	50/125 OM2	24	11.0	64
26600248	HITRONIC® HVN5000 4x12G 50/125 OM2	50/125 OM2	48	11.0	84
<b>Single-mode E 9 OS2</b>					
26600924	HITRONIC® HVN5000 2x12E 9/125 OS2	9/125 OS2	24	11.0	64
26600948	HITRONIC® HVN5000 4x12E 9/125 OS2	9/125 OS2	48	11.0	84
<b>HVN Telecom Single-mode E 9 OS2</b>					
26601924	HITRONIC® HVN1500 2x12E 9/125 OS2	9/125 OS2	24	10.5	89
26601948	HITRONIC® HVN1500 4x12E 9/125 OS2	9/125 OS2	48	10.5	91
26601972	HITRONIC® HVN2000 6x12E 9/125 OS2	9/125 OS2	72	10.8	97
26601996	HITRONIC® HVN2000 8x12E 9/125 OS2	9/125 OS2	96	11.9	121
26601944	HITRONIC® HVN2000 12x12E 9/125 OS2	9/125 OS2	144	14.3	183

Unless specified otherwise, the shown product values are nominal values. Detailed values (e.g. tolerances) are available upon request. The cables can also be supplied as pre-terminated fibre optic trunks. Photographs are not to scale and do not represent detailed images of the respective products. Other models are available upon request.

### Similar products

- HITRONIC® HVN-Mini Outdoor Cable refer to page 241
- HITRONIC® HVW Armoured Outdoor Cable refer to page 243



**New**

## HITRONIC® HVN-Mini Outdoor Cable

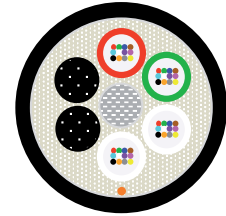

**Info**

- A-DQ(ZN)2Y
- Mini outdoor cable designed for installation by air-blowing systems (Micro Ducts)

### Benefits

- Suitable for blowing into micro-ducts
- Compact dimensions
- Low-friction outer sheath
- UV-resistant
- Zero electromagnetic interference as the cable contains no metal

### Application range

- For outdoor use, Backbone-Area
- For installations by blowing
- Telecommunications network
- WAN applications
- Methods of Deployment: empty plastic pipes, ducts and trays

### Product features

- Stranded loose tubes with up to 144 fibres (12 loose tubes with each 12 fibres)
- Colour-coded fibres and loose tubes
- Reduced dimensions
- Halogen-free outer sheath

### Design

- Up to 12 stranded gel-filled loose tubes
- Central GRP strength element
- Reinforced glass yarn strain relief
- PE outer sheath
- Colour: black (RAL 9005)

### Technical data

- Optical fibre type**  
Core material: glass  
Cladding material: glass
- Permissible bending radius**  
Static: ≥ 15 x outer diameter  
Dynamic: ≥ 20 x outer diameter
- Temperature range**  
Fixed installation: -40°C to +70°C

Article number	Article designation	Fibre type	Number of fibres	Outer diameter (mm)	Weight (kg/km)
<b>Single-mode E 9 OS2</b>					
26609912	HITRONIC® HVN-Mini500 1x12E 9/125 OS2	9/125 OS2	12	5.8	30
26609924	HITRONIC® HVN-Mini500 2x12E 9/125 OS2	9/125 OS2	24	5.8	30
26609948	HITRONIC® HVN-Mini500 4x12E 9/125 OS2	9/125 OS2	48	5.8	33
26609972	HITRONIC® HVN-Mini500 6x12E 9/125 OS2	9/125 OS2	72	5.8	33
26609996	HITRONIC® HVN-Mini1200 8x12E 9/125 OS2	9/125 OS2	96	7.2	52
26609944	HITRONIC® HVN-Mini1000 12x12E 9/125	9/125 OS2	144	8.0	80

Unless specified otherwise, the shown product values are nominal values. Detailed values (e.g. tolerances) are available upon request. Photographs are not to scale and do not represent detailed images of the respective products.



## HITRONIC® HQW Armoured Outdoor Cable

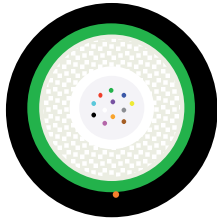

**Info**

- A-DQ(ZN)(SR)2Y
- Double-sheathed outdoor cable with corrugated steel tape armour, and non-metallic strength elements

### Benefits

- Armouring provides excellent protection against high mechanical stress and rodents
- Suitable for direct burial
- Easy to install due to the compact design, high flexibility, robust sheath and small bending radii
- UV-resistant longitudinally and laterally watertight

### Application range

- For outdoor use
- Campus backbone
- WAN applications
- Industrial environments
- Methods of Deployment: empty plastic pipes, ducts and trays

### Product features

- Central loose tube with up to 24 fibres
- Colour-coded fibres
- Longitudinal watertight
- Excellent rodent protection
- Robust, halogen-free outer sheath

### Design

- Gel-filled loose tube
- Water-blocking reinforced glass yarn strain relief
- Corrugated steel tape armour
- PE outer sheath
- Colour: black (RAL 9005)

### Technical data

- Optical fibre type**  
Core material: glass  
Cladding material: glass
- Permissible bending radius**  
Static:  $\geq 15 \times$  outer diameter  
Dynamic:  $\geq 20 \times$  outer diameter
- Permissible tensile force**  
Fixed installation: 3000 N  
Short-term: 5000 N
- Temperature range**  
Fixed installation:  $-40^{\circ}\text{C}$  to  $+70^{\circ}\text{C}$

Article number	Article designation	Fibre type	Number of fibres	Outer diameter (mm)	Weight (kg/km)
<b>Multimode G 50 OM3</b>					
27900304	HITRONIC® HQW3000 4G 50/125 OM3	50/125 OM3	4	9.6	88
27900308	HITRONIC® HQW3000 8G 50/125 OM3	50/125 OM3	8	9.6	88
27900312	HITRONIC® HQW3000 12G 50/125 OM3	50/125 OM3	12	9.6	88
27900324	HITRONIC® HQW3000 24G 50/125 OM3	50/125 OM3	24	9.6	88
<b>Multimode G 50 OM2</b>					
27900204	HITRONIC® HQW3000 4G 50/125 OM2	50/125 OM2	4	9.6	88
27900208	HITRONIC® HQW3000 8G 50/125 OM2	50/125 OM2	8	9.6	88
27900212	HITRONIC® HQW3000 12G 50/125 OM2	50/125 OM2	12	9.6	88
27900224	HITRONIC® HQW3000 24G 50/125 OM2	50/125 OM2	24	9.6	88
<b>Multimode G 62.5 OM1</b>					
27900104	HITRONIC® HQW3000 4G 62.5/125 OM1	62.5/125 OM1	4	9.6	88
27900108	HITRONIC® HQW3000 8G 62.5/125 OM1	62.5/125 OM1	8	9.6	88
27900112	HITRONIC® HQW3000 12G 62.5/125 OM1	62.5/125 OM1	12	9.6	88
27900124	HITRONIC® HQW3000 24G 62.5/125 OM1	62.5/125 OM1	24	9.6	88
<b>Single-mode E 9 OS2</b>					
27900904	HITRONIC® HQW3000 4E 9/125 OS2	9/125 OS2	4	9.6	88
27900908	HITRONIC® HQW3000 8E 9/125 OS2	9/125 OS2	8	9.6	88
27900912	HITRONIC® HQW3000 12E 9/125 OS2	9/125 OS2	12	9.6	88
27900924	HITRONIC® HQW3000 24E 9/125 OS2	9/125 OS2	24	9.6	88

Unless specified otherwise, the shown product values are nominal values. Detailed values (e.g. tolerances) are available upon request. The cables can also be supplied as pre-terminated fibre optic trunks. Photographs are not to scale and do not represent detailed images of the respective products.

### Accessories

- STAR STRIP stripping tool
- SMART STRIP stripping tool



**New**

## HITRONIC® HVW Armoured Outdoor Cable

**Info**

- A-DQ(ZN)B2Y(SR)2Y
- Outdoor cable with corrugated steel tape armour, stranded loose tubes and non-metallic strain relief

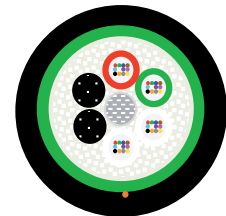

**Benefits**

- Armouring provides excellent protection against high mechanical stress and rodents
- Suitable for direct burial
- Easy to install due to the compact design, high flexibility, robust sheath and small bending radii
- UV-resistant longitudinally and laterally watertight

**Application range**

- Methods of Deployment: empty plastic pipes, ducts and trays
- For outdoor use
- Campus backbone
- WAN applications
- Industrial environments

**Product features**

- Stranded loose tubes with up to 144 fibres (12 loose tubes with each 12 fibres)
- Colour-coded fibres and loose tubes
- Longitudinal watertight
- Excellent rodent protection
- Robust, halogen-free outer sheath

**Design**

- Up to 12 stranded gel-filled loose tubes
- Water-blocking reinforced glass yarn strain relief
- Corrugated steel tape armour
- PE outer sheath
- Colour: black (RAL 9005)

**Technical data**

- Optical fibre type**  
Core material: glass  
Cladding material: glass
- Permissible bending radius**  
Static:  $\geq 15 \times$  outer diameter  
Dynamic:  $\geq 20 \times$  outer diameter
- Permissible tensile force**  
Fixed installation: 3000 N  
Short-term: 5000 N
- Temperature range**  
Fixed installation:  $-40^{\circ}\text{C}$  to  $+70^{\circ}\text{C}$

Article number	Article designation	Fibre type	Number of fibres	Outer diameter (mm)	Weight (kg/km)
<b>Single-mode E 9 OS2</b>					
26900924	HITRONIC® HVW3000 2x12E 9/125 OS2	9/125 OS2	24	10.0	98
26900948	HITRONIC® HVW3000 4x12E 9/125 OS2	9/125 OS2	48	12.5	148
26900972	HITRONIC® HVW3000 6x12E 9/125 OS2	9/125 OS2	72	16.0	215
26900996	HITRONIC® HVW3000 8x12E 9/125 OS2	9/125 OS2	96	16.0	222
26900944	HITRONIC® HVW3000 12x12E 9/125 OS2	9/125 OS2	144	18.5	261

Unless specified otherwise, the shown product values are nominal values. Detailed values (e.g. tolerances) are available upon request. The cables can also be supplied as pre-terminated fibre optic trunks. Photographs are not to scale and do not represent detailed images of the respective products.



New

## HITRONIC® HQW-Plus Armoured Outdoor Cable

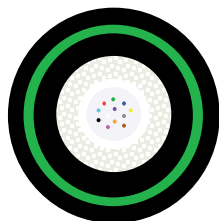

Info

- A-DQ(ZN)B2Y(SR)2Y
- Double-sheathed outdoor cable with corrugated steel tape armour, and non-metallic strength elements

### Benefits

- Additional sheath protects the fibres for use in harsh environments
- Armouring provides excellent protection against high mechanical stress and rodents
- Suitable for direct burial
- UV-resistant longitudinally and laterally watertight

### Application range

- For outdoor use
- Harsh industrial environment
- Campus backbone
- WAN applications
- Methods of Deployment: empty plastic pipes, ducts and trays

### Product features

- Central loose tube with up to 24 fibres
- Colour-coded fibres
- Longitudinal watertight
- Excellent rodent protection
- Robust, halogen-free outer sheath

### Design

- Gel-filled loose tube
- Water-blocking reinforced glass yarn strain relief
- Corrugated steel tape armour
- PE inner and outer sheaths
- Colour: black (RAL 9005)

### Technical data



#### Optical fibre type

Core material: glass  
Cladding material: glass



#### Permissible bending radius

Static: ≥ 15 x outer diameter  
Dynamic: ≥ 20 x outer diameter



#### Permissible tensile force

Fixed installation: 3000 N  
Short-term: 5000 N



#### Temperature range

Fixed installation: -40°C to +70°C

Article number	Article designation	Fibre type	Number of fibres	Outer diameter (mm)	Weight (kg/km)
<b>Multimode G 50 OM3</b>					
27920304	HITRONIC® HQW-Plus3000 4G 50/125 OM3	50/125 OM3	4	9.6	95
27920308	HITRONIC® HQW-Plus3000 8G 50/125 OM3	50/125 OM3	8	9.6	95
27920312	HITRONIC® HQW-Plus3000 12G 50/125 OM3	50/125 OM3	12	9.6	95
27920324	HITRONIC® HQW-Plus3000 24G 50/125 OM3	50/125 OM3	24	12.6	135
<b>Multimode G 50 OM2</b>					
27920204	HITRONIC® HQW-Plus3000 4G 50/125 OM2	50/125 OM2	4	9.6	95
27920208	HITRONIC® HQW-Plus3000 8G 50/125 OM2	50/125 OM2	8	9.6	95
27920212	HITRONIC® HQW-Plus3000 12G 50/125 OM2	50/125 OM2	12	9.6	95
27920224	HITRONIC® HQW-Plus3000 24G 50/125 OM2	50/125 OM2	24	12.6	135
<b>Multimode G 62.5 OM1</b>					
27920104	HITRONIC® HQW-Plus3000 4G 62.5/125 OM1	62.5/125 OM1	4	9.6	95
27920108	HITRONIC® HQW-Plus3000 8G 62.5/125 OM1	62.5/125 OM1	8	9.6	95
27920112	HITRONIC® HQW-Plus3000 12G 62.5/125 OM1	62.5/125 OM1	12	9.6	95
27920124	HITRONIC® HQW-Plus3000 24G 62.5/125 OM1	62.5/125 OM1	24	12.6	135
<b>Single-mode E 9 OS2</b>					
27920904	HITRONIC® HQW-Plus3000 4E 9/125 OS2	9/125 OS2	4	9.6	95
27920908	HITRONIC® HQW-Plus3000 8E 9/125 OS2	9/125 OS2	8	9.6	95
27920912	HITRONIC® HQW-Plus3000 12E 9/125 OS2	9/125 OS2	12	9.6	95
27920924	HITRONIC® HQW-Plus3000 24E 9/125 OS2	9/125 OS2	24	12.6	135

Photographs are not to scale and do not represent detailed images of the respective products.





**New**

## HITRONIC® HQA Aerial Cable

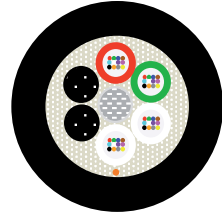

**Info**

- A-DQ(ZN)2Y - ADSS
- Outdoor self-supporting aerial cable with stranded loose tubes and non-metallic strain relief

### Benefits

- Suitable for mild weather conditions
- Easy to install due to the compact design, high flexibility, robust sheath and small bending radii
- UV-resistant longitudinally and laterally watertight
- Zero electromagnetic interference as the cable contains no metal

### Application range

- For outdoor use
- Hanging on poles

### Product features

- Stranded loose tubes with up to 96 fibres
- Colour-coded fibres and loose tubes
- Longitudinal watertight
- Robust, halogen-free outer sheath
- Span width up to 90m

### Design

- Up to 8 stranded gel-filled loose tubes
- Central GRP strength element
- Aramid yarns as strain relief
- PE outer sheath
- Colour: black (RAL 9005)

### Technical data

**Optical fibre type**  
Core material: glass  
Cladding material: glass

**Permissible bending radius**  
Static: ≥ 15 x outer diameter  
Dynamic: ≥ 20 x outer diameter

**Permissible tensile force**  
MAT: 2000 N  
EDS: 800 N

**Temperature range**  
Fixed installation: -40°C to +70°C  
Occasional flexing: -30°C to +70°C

Article number	Article designation	Fibre type	Number of fibres	Outer diameter (mm)	Weight (kg/km)
<b>Single-mode E 9 OS2</b>					
26640912	HITRONIC® HQA800 6x2E 9/125 OS2	9/125 OS2	12	9.7	73
26640924	HITRONIC® HQA800 6x4E 9/125 OS2	9/125 OS2	24	9.7	73
26640948	HITRONIC® HQA800 6x8E 9/125 OS2	9/125 OS2	48	10.9	92
26640972	HITRONIC® HQA800 6x12E 9/125 OS2	9/125 OS2	72	10.9	94
26640996	HITRONIC® HQA800 8x12E 9/125 OS2	9/125 OS2	96	12.4	121

Unless specified otherwise, the shown product values are nominal values. Detailed values (e.g. tolerances) are available upon request. Photographs are not to scale and do not represent detailed images of the respective products.



**New**

## HITRONIC® HQA-Plus Aerial Cable

**Info**

- A-DQ2Y(ZN)2Y ADSS
- Double-sheathed, self-supporting aerial cable with stranded loose tubes and non-metallic strain relief

### Benefits

- Designed to withstand harsh weather conditions
- Easy to install due to the compact design, high flexibility, robust sheath and small bending radii
- UV-resistant longitudinally and laterally watertight
- Zero electromagnetic interference as the cable contains no metal

### Application range

- For long span widths
- Hanging on poles
- For outdoor use

### Product features

- Stranded loose tubes with up to 96 fibres
- Colour-coded fibres and loose tubes
- Longitudinal watertight
- Robust, halogen-free outer sheath
- Span width up to 250m

### Design

- Up to 8 stranded gel-filled loose tubes
- Central GRP strength element
- Aramid yarns as strain relief
- PE inner and outer sheaths
- Colour: black (RAL 9005)

### Technical data

**Optical fibre type**  
Core material: glass  
Cladding material: glass

**Permissible bending radius**  
Static: ≥ 15 x outer diameter  
Dynamic: ≥ 20 x outer diameter

**Permissible tensile force**  
MAT: 8000 N  
EDS: 3200 N

**Temperature range**  
Fixed installation: -40°C to +70°C  
Occasional flexing: -30°C to +70°C

Article number	Article designation	Fibre type	Number of fibres	Outer diameter (mm)	Weight (kg/km)
<b>Single-mode E 9 OS2</b>					
26644912	HITRONIC® HQA-Plus3200 6x2E 9/125 OS2	9/125 OS2	12	12.8	132
26644924	HITRONIC® HQA-Plus3200 6x4E 9/125 OS2	9/125 OS2	24	12.8	132
26644948	HITRONIC® HQA-Plus3200 6x8E 9/125 OS2	9/125 OS2	48	13.7	151
26644972	HITRONIC® HQA-Plus3200 6x12E 9/125 OS2	9/125 OS2	72	13.7	153
26644996	HITRONIC® HQA-Plus3200 8x12E 9/125 OS2	9/125 OS2	96	15.3	188

Photographs are not to scale and do not represent detailed images of the respective products.



## HITRONIC® HUN Universal Cable

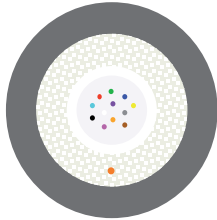

**Info**

- A/J-DQ(ZN)BH or U-DQ(ZN)BH
- Universal cable with central or stranded loose tube and non-metallic strain relief

### Benefits

- Flame retardance makes it suitable for indoor and outdoor installations
- Easy to install due to the compact design, high flexibility, robust sheath and small bending radii
- UV-resistant longitudinally and laterally watertight
- Zero electromagnetic interference as the cable contains no metal

### Application range

- For indoor and outdoor use
- Campus backbone
- Industrial environments
- Methods of Deployment: empty plastic pipes, ducts and trays

### Product features

- Central loose tube with up to 24 fibres
- Colour-coded fibres
- Longitudinal watertight
- Flame-retardant and halogen-free outer sheath
- Rodent-protection

### Design

- Glass fibres with primary coating
- Gel-filled loose tube
- Water-blocking reinforced glass yarn strain relief
- LSZH outer sheath
- Colour: dark grey

### Technical data

- Optical fibre type**  
Core material: glass  
Cladding material: glass
- Permissible bending radius**  
Static: ≥ 15 x outer diameter  
Dynamic: ≥ 20 x outer diameter
- Permissible tensile force**  
Fixed installation: 1500 N  
Short-term: 2000 N
- Temperature range**  
Fixed installation: -30°C to +70°C

Article number	Article designation	Fibre type	Number of fibres	Outer diameter (mm)	Weight (kg/km)
<b>Multimode G 50 OM3</b>					
27400304	HITRONIC® HUN1500 4G 50/125 OM3	50/125 OM3	4	7.3	53
27400308	HITRONIC® HUN1500 8G 50/125 OM3	50/125 OM3	8	7.3	53
27400312	HITRONIC® HUN1500 12G 50/125 OM3	50/125 OM3	12	7.3	53
27400324	HITRONIC® HUN1500 24G 50/125 OM3	50/125 OM3	24	8.3	60
26400324	HITRONIC® HUN1500 2x12G 50/125 OM3	50/125 OM3	24	10.1	84
26400348	HITRONIC® HUN1500 4x12G 50/125 OM3	50/125 OM3	48	11.0	109
<b>Multimode G 50 OM2</b>					
27400204	HITRONIC® HUN1500 4G 50/125 OM2	50/125 OM2	4	7.3	53
27400208	HITRONIC® HUN1500 8G 50/125 OM2	50/125 OM2	8	7.3	53
27400212	HITRONIC® HUN1500 12G 50/125 OM2	50/125 OM2	12	7.3	53
27400224	HITRONIC® HUN1500 24G 50/125 OM2	50/125 OM2	24	8.3	60
<b>Multimode G 62.5 OM1</b>					
27400104	HITRONIC® HUN1500 4G 62.5/125 OM1	62.5/125 OM1	4	7.3	53
27400108	HITRONIC® HUN1500 8G 62.5/125 OM1	62.5/125 OM1	8	7.3	53
27400112	HITRONIC® HUN1500 12G 62.5/125 OM1	62.5/125 OM1	12	7.3	53
27400124	HITRONIC® HUN1500 24G 62.5/125 OM1	62.5/125 OM1	24	8.3	60
<b>Single-mode E 9 OS2</b>					
27400904	HITRONIC® HUN1500 4E 9/125 OS2	9/125 OS2	4	7.3	53
27400908	HITRONIC® HUN1500 8E 9/125 OS2	9/125 OS2	8	7.3	53
27400912	HITRONIC® HUN1500 12E 9/125 OS2	9/125 OS2	12	7.3	53
27400924	HITRONIC® HUN1500 24E 9/125 OS2	9/125 OS2	24	8.3	60
26400924	HITRONIC® HUN1500 2x12E 9/125 OS2	9/125 OS2	24	10.1	84
26400948	HITRONIC® HUN1500 4x12E 9/125 OS2	9/125 OS2	48	11.0	109
26400972	HITRONIC® HUN2000 6x12E 9/125 OS2	9/125 OS2	72	12.6	148
26400996	HITRONIC® HUN2000 8x12E 9/125 OS2	9/125 OS2	96	14.3	190
26400944	HITRONIC® HUN2000 12x12E 9/125 OS2	9/125 OS2	144	17.0	221

Unless specified otherwise, the shown product values are nominal values. Detailed values (e.g. tolerances) are available upon request. The cables can also be supplied as pre-terminated fibre optic trunks. Photographs are not to scale and do not represent detailed images of the respective products. Available on request with Multimode OM4 fibres.

### Accessories

- GOF SIMPLEX Pigtail refer to page 251
- DATA STRIP stripping tool



## HITRONIC® HUW Armoured Universal Cable

**Info**

- A/J-DQ(ZN)(SR)H or U-DQ(ZN)(SR)H
- Universal cable with corrugated steel tape armour, central loose tube and non-metallic strain relief



### Benefits

- Armouring provides excellent protection against high mechanical stress and rodents
- Flame retardance makes it suitable for indoor and outdoor installations
- Easy to install due to the compact design, high flexibility, robust sheath and small bending radii
- Water-resistant

### Application range

- For indoor and outdoor use
- Campus backbone
- Industrial environments
- Methods of Deployment: empty plastic pipes, ducts and trays

### Product features

- Flame-retardant and halogen-free outer sheath
- Central loose tube with up to 24 fibres
- Colour-coded fibres
- Longitudinal watertight
- Excellent rodent protection

### Design

- Gel-filled loose tube
- Water-blocking reinforced glass yarn strain relief
- Corrugated steel tape armour
- LSZH outer sheath
- Colour: green (based on RAL 6018)

### Technical data

- Optical fibre type**  
Core material: glass  
Cladding material: glass
- Permissible bending radius**  
Static:  $\geq 15 \times$  outer diameter  
Dynamic:  $\geq 20 \times$  outer diameter
- Permissible tensile force**  
Fixed installation: 1500 N  
Short-term: 2000 N
- Temperature range**  
Fixed installation:  $-30^{\circ}\text{C}$  to  $+70^{\circ}\text{C}$

Article number	Article designation	Fibre type	Number of fibres	Outer diameter (mm)	Weight (kg/km)
<b>Multimode G 50 OM4</b>					
27500404	HITRONIC® HUW1500 4G 50/125 OM4	50/125 OM4	4	9.6	88
27500408	HITRONIC® HUW1500 8G 50/125 OM4	50/125 OM4	8	9.6	88
27500412	HITRONIC® HUW1500 12G 50/125 OM4	50/125 OM4	12	9.6	88
27500424	HITRONIC® HUW1500 24G 50/125 OM4	50/125 OM4	24	9.6	88
<b>Multimode G 50 OM3</b>					
27500304	HITRONIC® HUW1500 4G 50/125 OM3	50/125 OM3	4	9.6	88
27500308	HITRONIC® HUW1500 8G 50/125 OM3	50/125 OM3	8	9.6	88
27500312	HITRONIC® HUW1500 12G 50/125 OM3	50/125 OM3	12	9.6	88
27500324	HITRONIC® HUW1500 24G 50/125 OM3	50/125 OM3	24	9.6	88
<b>Multimode G 50 OM2</b>					
27500204	HITRONIC® HUW1500 4G 50/125 OM2	50/125 OM2	4	9.6	88
27500208	HITRONIC® HUW1500 8G 50/125 OM2	50/125 OM2	8	9.6	88
27500212	HITRONIC® HUW1500 12G 50/125 OM2	50/125 OM2	12	9.6	88
27500224	HITRONIC® HUW1500 24G 50/125 OM2	50/125 OM2	24	9.6	88
<b>Multimode G 62.5 OM1</b>					
27500104	HITRONIC® HUW1500 4G 62.5/125 OM1	62.5/125 OM1	4	9.6	88
27500108	HITRONIC® HUW1500 8G 62.5/125 OM1	62.5/125 OM1	8	9.6	88
27500112	HITRONIC® HUW1500 12G 62.5/125 OM1	62.5/125 OM1	12	9.6	88
27500124	HITRONIC® HUW1500 24G 62.5/125 OM1	62.5/125 OM1	24	9.6	88
<b>Single-mode E 9 OS2</b>					
27500904	HITRONIC® HUW1500 4E 9/125 OS2	9/125 OS2	4	9.6	88
27500908	HITRONIC® HUW1500 8E 9/125 OS2	9/125 OS2	8	9.6	88
27500912	HITRONIC® HUW1500 12E 9/125 OS2	9/125 OS2	12	9.6	88
27500924	HITRONIC® HUW1500 24E 9/125 OS2	9/125 OS2	24	9.6	88

Unless specified otherwise, the shown product values are nominal values. Detailed values (e.g. tolerances) are available upon request.

The cables can also be supplied as pre-terminated fibre optic trunks.

Photographs are not to scale and do not represent detailed images of the respective products.

### Accessories

- STAR STRIP stripping tool
- SMART STRIP stripping tool



## HITRONIC® HRH Breakout Cable

LAPP KABEL STUÏTGART HITRONIC® HRH1700 12G 50/125 OM2



LAPP KABEL STUÏTGART HITRONIC® HRH400 2G 50/125 OM3

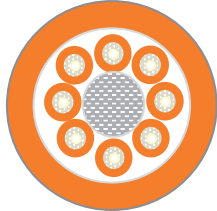

**Info**

- J-V(ZN)HH
- Breakout cable for direct connector assembly

### Benefits

- Suitable for field assembly
- Universal cable for cabling of buildings
- Very easy to install due to compact design, high flexibility, and small bending radii
- Zero electromagnetic interference as the cable contains no metal

### Application range

- For indoor use
- Tertiary cabling
- Structured cabling - backbone
- Methods of Deployment: laying in trunking, ducts, trays, empty plastic pipes, building riser, raised floors and plenums

### Product features

- Installation cable with up to 12 Simplex cables
- Flame-retardant and halogen-free outer sheath
- Mechanically robust

### Design

- 2.1 mm tight-buffered sub-cable with LSZH sheath (identified by numbers)
- Central GRP strength element
- Aramid yarns as strain relief
- LSZH inner and outer sheaths
- Colour: aqua (RAL 6027) for OM3, orange (RAL 2003) for OM2 and OM1

### Technical data

**Optical fibre type**  
Core material: glass  
Cladding material: glass

**Permissible bending radius**  
Static: ≥ 15 x outer diameter  
Dynamic: ≥ 20 x outer diameter

**Temperature range**  
Fixed installation: -20°C to +70°C

Article number	Article designation	Fibre type	Number of fibres	Outer diameter (mm)	Weight (kg/km)
<b>Multimode G 50 OM3</b>					
26000302	HITRONIC® HRH400 2G 50/125 OM3	50/125 OM3	2	7.0	35
26000304	HITRONIC® HRH600 4G 50/125 OM3	50/125 OM3	4	7.0	44
26000308	HITRONIC® HRH1200 8G 50/125 OM3	50/125 OM3	8	9.7	77
26000312	HITRONIC® HRH1700 12G 50/125 OM3	50/125 OM3	12	10.3	100
<b>Multimode G 50 OM2</b>					
26000202	HITRONIC® HRH400 2G 50/125 OM2	50/125 OM2	2	7.0	35
26000204	HITRONIC® HRH600 4G 50/125 OM2	50/125 OM2	4	7.0	44
26000208	HITRONIC® HRH1200 8G 50/125 OM2	50/125 OM2	8	9.7	77
26000212	HITRONIC® HRH1700 12G 50/125 OM2	50/125 OM2	12	10.3	100
<b>Multimode G 62.5 OM1</b>					
26000102	HITRONIC® HRH400 2G 62.5/125 OM1	62.5/125 OM1	2	7.0	35
26000104	HITRONIC® HRH600 4G 62.5/125 OM1	62.5/125 OM1	4	7.0	44
26000108	HITRONIC® HRH1200 8G 62.5/125 OM1	62.5/125 OM1	8	9.7	77
26000112	HITRONIC® HRH1700 12G 62.5/125 OM1	62.5/125 OM1	12	10.3	100

Unless specified otherwise, the shown product values are nominal values. Detailed values (e.g. tolerances) are available upon request. The cables can also be supplied as pre-terminated fibre optic trunks. Photographs are not to scale and do not represent detailed images of the respective products. Available on request with Multimode OM4 fibres.

### Accessories

- DATA STRIP stripping tool



**New**

## HITRONIC® HDH Mini-Breakout Cable

**Info**

- J-V(ZN)H
- Mini breakout/distribution cable for direct connector assembly

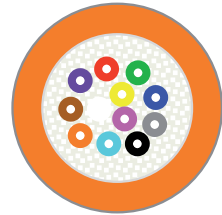
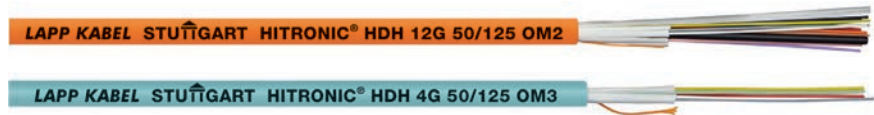

**Benefits**

- Very easy to install due to small dimensions, high flexibility, and small bending radius
- Suitable for field assembly
- Universal cable for cabling of buildings
- Zero electromagnetic interference as the cable contains no metal

**Application range**

- For indoor use
- Tertiary cabling
- Structured cabling - backbone
- Methods of Deployment: laying in trunking, ducts, trays, empty plastic pipes, building riser, raised floors and plenums

**Product features**

- Up to 12 tight-buffered fibres (900µm)
- Colour-coded fibres
- Flame-retardant and halogen-free outer sheath
- Mechanically robust

**Design**

- Tight-buffered fibres
- Water-blocking reinforced glass yarn strain relief
- LSZH outer sheath
- Colour: aqua (RAL 6027) for OM3, orange (RAL 2003) for OM2 and OM1
- Available on request: single-mode OS2 (yellow) and multimode OM4 (violet)

**Technical data**

- Optical fibre type**  
Core material: glass  
Cladding material: glass
- Permissible bending radius**  
Static: ≥ 15 x outer diameter  
Dynamic: ≥ 20 x outer diameter
- Temperature range**  
Fixed installation: -20°C to +70°C

Article number	Article designation	Fibre type	Number of fibres	Outer diameter (mm)	Weight (kg/km)
<b>Multimode G 50 OM3</b>					
26010302	HITRONIC® HDH 2G 50/125 OM3	50/125 OM3	2	6.0	34
26010304	HITRONIC® HDH 4G 50/125 OM3	50/125 OM3	4	6.3	37
26010308	HITRONIC® HDH 8G 50/125 OM3	50/125 OM3	8	7.5	57
26010312	HITRONIC® HDH 12G 50/125 OM3	50/125 OM3	12	8.3	69
<b>Multimode G 50 OM2</b>					
26010202	HITRONIC® HDH 2G 50/125 OM2	50/125 OM2	2	6.0	34
26010204	HITRONIC® HDH 4G 50/125 OM2	50/125 OM2	4	6.3	37
26010208	HITRONIC® HDH 8G 50/125 OM2	50/125 OM2	8	7.5	57
26010212	HITRONIC® HDH 12G 50/125 OM2	50/125 OM2	12	8.3	69
<b>Multimode G 62.5 OM1</b>					
26010102	HITRONIC® HDH 2G 62.5/125 OM1	62.5/125 OM1	2	6.0	34
26010104	HITRONIC® HDH 4G 62.5/125 OM1	62.5/125 OM1	4	6.3	37
26010108	HITRONIC® HDH 8G 62.5/125 OM1	62.5/125 OM1	8	7.5	57
26010112	HITRONIC® HDH 12G 62.5/125 OM1	62.5/125 OM1	12	8.3	69

Unless specified otherwise, the shown product values are nominal values. Detailed values (e.g. tolerances) are available upon request. The cables can also be supplied as pre-terminated fibre optic trunks. Photographs are not to scale and do not represent detailed images of the respective products.

**Accessories**

- DATA STRIP stripping tool



New

## GOF DUPLEX Patchcord



**Info**

- J-VH 2x1G/E
- Pre-terminated tight buffered duplex cable with durable ceramic ferrules

**Benefits**

- “Plug & Play” connection between any optical devices
- Non-permanent connections allow for easy change of equipment
- Direct connection between two active optical components
- Zero electromagnetic interference as the cable contains no metal

**Application range**

- For indoor use
- LAN connections
- Data Centers
- Distributor cabinet

**Product features**

- Flame-retardant and halogen-free outer sheath
- High flexibility
- Cable termination with durable ceramic ferrules

**Design**

- Tight-buffered duplex cable with LSZH outer sheath
- Connector: LC, SC or ST
- Cable colour: violet for multimode OM4, aqua for multimode OM3, orange for multimode OM2 and OM1, yellow for single-mode OS2
- Standard length: 2 m
- On request: 1 m, 3 m, 5 m and 10 m

**Technical data**



**Optical fibre type**

Core material: glass  
Cladding material: glass



**Permissible bending radius**

Static: ≥ 30 mm  
Dynamic: ≥ 40 mm



**Permissible tensile force**

Fixed installation: 100 N



**Temperature range**

Fixed installation: -20°C to +60°C  
Occasional flexing: -5°C to +50°C

Article number	Article designation	PU
<b>Multimode G 50 OM4</b>		
29011402	GOF Duplex Patchcord SC/SC G50 OM4, 2m	1 piece
29021402	GOF Duplex Patchcord ST/SC G50 OM4, 2m	1 piece
29022402	GOF Duplex Patchcord ST/ST G50 OM4, 2m	1 piece
29031402	GOF Duplex Patchcord LC/SC G50 OM4, 2m	1 piece
29032402	GOF Duplex Patchcord LC/ST G50 OM4, 2m	1 piece
29033402	GOF Duplex Patchcord LC/LC G50 OM4, 2m	1 piece
29044402	GOF Duplex Patchcord FC/FC G50 OM4, 2m	1 piece
<b>Multimode G 50 OM3</b>		
29011302	GOF Duplex Patchcord SC/SC G50 OM3, 2m	1 piece
29021302	GOF Duplex Patchcord ST/SC G50 OM3, 2m	1 piece
29022302	GOF Duplex Patchcord ST/ST G50 OM3, 2m	1 piece
29031302	GOF Duplex Patchcord LC/SC G50 OM3, 2m	1 piece
29032302	GOF Duplex Patchcord LC/ST G50 OM3, 2m	1 piece
29033302	GOF Duplex Patchcord LC/LC G50 OM3, 2m	1 piece
29044302	GOF Duplex Patchcord FC/FC G50 OM3, 2m	1 piece
<b>Multimode G 50 OM2</b>		
29011202	GOF Duplex Patchcord SC/SC G50 OM2, 2m	1 piece
29021202	GOF Duplex Patchcord ST/SC G50 OM2, 2m	1 piece
29022202	GOF Duplex Patchcord ST/ST G50 OM2, 2m	1 piece
29031202	GOF Duplex Patchcord LC/SC G50 OM2, 2m	1 piece
29032202	GOF Duplex Patchcord LC/ST G50 OM2, 2m	1 piece
29033202	GOF Duplex Patchcord LC/LC G50 OM2, 2m	1 piece
29044202	GOF Duplex Patchcord FC/FC G50 OM2, 2m	1 piece
<b>Multimode G 62.5 OM1</b>		
29011102	GOF Duplex Patchcord SC/SC G62.5, 2m	1 piece
29021102	GOF Duplex Patchcord ST/SC G62.5, 2m	1 piece
29022102	GOF Duplex Patchcord ST/ST G62.5, 2m	1 piece
29031102	GOF Duplex Patchcord LC/SC G62.5, 2m	1 piece
29032102	GOF Duplex Patchcord LC/ST G62.5, 2m	1 piece
29033102	GOF Duplex Patchcord LC/LC G62.5, 2m	1 piece
29044102	GOF Duplex Patchcord FC/FC G62.5, 2m	1 piece
<b>Single-mode E 9 OS2</b>		
29011902	GOF Duplex Patchcord SC/SC E9 OS2, 2m	1 piece
29021902	GOF Duplex Patchcord ST/SC E9 OS2, 2m	1 piece
29022902	GOF Duplex Patchcord ST/ST E9 OS2, 2m	1 piece
29031902	GOF Duplex Patchcord LC/SC E9 OS2, 2m	1 piece
29032902	GOF Duplex Patchcord LC/ST E9 OS2, 2m	1 piece
29033902	GOF Duplex Patchcord LC/LC E9 OS2, 2m	1 piece

Other lengths and types of connectors are available upon request.  
Photographs are not to scale and do not represent detailed images of the respective products.





**New**

## GOF SIMPLEX Pigtail



**Info**

- J-VH 1G/E
- Pre-terminated tight-buffered simplex cable with one durable ceramic ferrule



**Benefits**

- Ease of installation and assembly
- Create a direct plug connection for installation cables with splicing
- Zero electromagnetic interference as the cable contains no metal

**Application range**

- For indoor use
- Connection to an end optical device

**Product features**

- Flame-retardant and halogen-free outer sheath
- High flexibility
- Cable termination with durable ceramic ferrules
- Set consisting of 12 colour-coded pigtails

**Design**

- Tight-buffered simplex fibre with LSZH outer sheath
- Connector: LC, SC or ST
- Colour-coded primary and secondary coatings
- Standard length: 2 m

**Technical data**

- Optical fibre type**  
Core material: glass  
Cladding material: glass
- Permissible tensile force**  
Fixed installation: 100 N
- Temperature range**  
Fixed installation: -20°C to +60°C  
Occasional flexing: -5°C to +50°C

Article number	Article designation	PU
<b>Multimode G 50 OM4</b>		
29310402	GOF Simplex Pigtail SC G50 OM4, 2m	12 piece
29320402	GOF Simplex Pigtail ST G50 OM4, 2m	12 piece
29330402	GOF Simplex Pigtail LC G50 OM4, 2m	12 piece
<b>Multimode G 50 OM3</b>		
29310302	GOF Simplex Pigtail SC G50 OM3, 2m	12 piece
29320302	GOF Simplex Pigtail ST G50 OM3, 2m	12 piece
29330302	GOF Simplex Pigtail LC G50 OM3, 2m	12 piece
<b>Multimode G 50 OM2</b>		
29310202	GOF Simplex Pigtail SC G50 OM2, 2m	12 piece
29320202	GOF Simplex Pigtail ST G50 OM2, 2m	12 piece
29330202	GOF Simplex Pigtail LC G50 OM2, 2m	12 piece
<b>Multimode G 62.5 OM1</b>		
29310102	GOF Simplex Pigtail SC G62.5, 2m	12 piece
29320102	GOF Simplex Pigtail ST G62.5, 2m	12 piece
29330102	GOF Simplex Pigtail LC G62.5, 2m	12 piece
<b>Single-mode E 9 OS2</b>		
29310902	GOF Simplex Pigtail SC E9 OS2, 2m	12 piece
29320902	GOF Simplex Pigtail ST E9 OS2, 2m	12 piece
29330902	GOF Simplex Pigtail LC E9 OS2, 2m	12 piece

Other types of connectors (e.g. LC, MTRJ, E2000) are available upon request. Judy Lim: This will not apply to Hitronic anymore, as LC will become a standard product and MTRJ/E2000 will be removed. Photographs are not to scale and do not represent detailed images of the respective products.

New

## GOF Connector

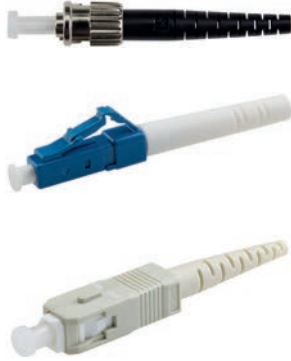

### Benefits

- Ideal for assembling
- For assembly process: cable preparation/ glueing/crimping/polishing
- Assembly instructions can be found in the GOF assembly toolbox (not included in Lapp product range)
- Trained optical installers should be used in all connector assembly

### Application range

- For connector assemblies in production or laboratory environment

### Product features

- Connector sets include all needed parts for assembly

### Norm references / Approvals

- LC comply with IEC standard 61754-20
- SC comply with IEC standard 61754-4
- ST comply with IEC standard 61754-2

### Technical data



#### Permissible tensile force

Tensile load 70N  
Tensile strength after assembly > 100N



#### Temperature range

Operating  
LC: -40°C to 75°C  
SC: -40°C to 75°C  
ST: -40°C to 85°C  
Humidity 95%  
Flammability UL 94 V-0

### Design

- Ferrule diameter:  
LC: 1.25mm (zirconia)  
SC, ST: 2.5mm (zirconia)
- Can be assembled with cables of 1.7mm-2.1mm diameter
- LC and SC connector sets available in green (single-mode APC), blue (single-mode PC) and grey (multimode)

Article number	Article designation	PU
<b>Singlemode</b>		
29110999	GOF Connector SC Single-mode Blue /4PC	4 piece
29110998	GOF Connector SC Single-mode Blue /50PC	50 piece
29110989	GOF Connector SC Single-mode APC Green/ 4PC	4 piece
29110988	GOF Connector SC Single-mode APC Green/ 50PC	50 piece
29130999	GOF Connector LC Single-mode Blue /4PC	4 piece
29130998	GOF Connector LC Single-mode Blue /50PC	50 piece
29130989	GOF Connector LC Single-mode APC GR /4PC	4 piece
29130988	GOF Connector LC Single-mode APC GR/50PC	50 piece
29120999	GOF Connector ST Single-mode /4PC	4 piece
29120998	GOF Connector ST Single-mode /50PC	50 piece
29140999	GOF Connector FC Single-mode /4PC	4 piece
<b>Multimode</b>		
29110199	GOF Connector SC Multimode Beige /4PC	4 piece
29110198	GOF Connector SC Multimode Beige /50PC	50 piece
29130199	GOF Connector LC Multimode Beige /4PC	4 piece
29130198	GOF Connector LC Multimode Beige /50PC	50 piece
29120199	GOF Connector ST Multimode /4PC	4 piece
29120198	GOF Connector ST Multimode /50PC	50 piece
29140199	GOF Connector FC Multimode /4PC	4 piece

Photographs are not to scale and do not represent detailed images of the respective products.

New

## GOF Adapters

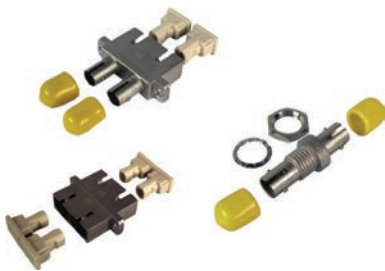

### Product features

- The couplings connect the glass fibre connectors with the same or different connector types.

### Norm references / Approvals

- LC comply with IEC standard 61754-20
- SC comply with IEC standard 61754-4
- ST comply with IEC standard 61754-2
- Comply with IEC, EIA/TIA standards

### Design

- Zirconia sleeves
- LC and SC adapters available in green (single-mode APC), blue (single-mode PC) and grey (multimode)

### Technical data

#### Attenuation

Attenuation (dB) < 0.2  
Repeatability  
1000 cycles (dB) < 0.2



#### Temperature range

Operating  
LC: -25°C to 70°C  
SC: -40°C to 75°C  
ST: -40°C to 85°C  
Humidity 95%  
Flammability UL 94 V-0

Article number	Article designation	PU
<b>Singlemode</b>		
29410999	GOF Adapter Duplex SC Single-mode Blue /4PC	4 piece
29410989	GOF Adapter Duplex SC Single-mode APC Green /4PC	4 piece
29430999	GOF Adapter Duplex LC Single-mode Blue /4PC	4 piece
29430989	GOF Adapter Duplex LC Single-mode APC Green /4PC	4 piece
29420999	GOF Adapter Simplex ST(BFOC) Single-mode /4PC	4 piece
29421999	GOF Adapter Duplex ST-SC Single-mode /4PC	4 piece
<b>Multimode</b>		
29410199	GOF Adapter Duplex SC Multimode Beige /4PC	4 piece
29430199	GOF Adapter Duplex LC Multimode Beige /4PC	4 piece
29420199	GOF Adapter Simplex ST(BFOC) Multimode /4PC	4 piece
29421199	GOF Adapter Duplex ST-SC Multimode /4PC	4 piece

Photographs are not to scale and do not represent detailed images of the respective products.





## 19" Splice Box for ST

**Product features**

- For up to 12 or 24 fibres
- Can be pulled out
- Unpopulated
- For a maximum of 4 splicing cartridges
- Height: 1 RU
- Dimensions (WxHxD): 483 x 44.5 x 244 mm
- Material: steel plate, 1.5 mm
- Colour: light grey (RAL 7035)



Article number	Article designation	PU
<b>Splice Box Compact</b>		
CE9138	19" Splice Box for 12 ST	1 piece
CE9139	19" Splice Box for 24 ST	1 piece

Splice boxes for more fibres with other types of connectors are available upon request. Also available in pre-assembled versions with couplings and pigtails. Photographs are not to scale and do not represent detailed images of the respective products.



## 19" Splice Box for SC

**Product features**

- For up to 24 fibres
- Included: front panel with 12 SC-duplex holes
- Can be pulled out
- Unpopulated
- Height: 1 RU
- Dimensions (WxHxD): 483 x 44.5 x 170 mm
- Material: steel plate, 1.5 mm
- Colour: light grey (RAL 7035)



Article number	Article designation	PU
<b>Splice Box Compact</b>		
CE9135	19" Splice Box for SC	1 piece

Splice boxes for more fibres with other types of connectors are available upon request. Also available in pre-assembled versions with couplings and pigtails. Photographs are not to scale and do not represent detailed images of the respective products.



## Splice Box Compact

**Product features**

- Panel mounting
- Lockable
- Max. capacity of 8 splicing cartridges or 4 splicing cartridges and one distribution plate
- Includes distributor plate for 8 ST couplings
- Includes distributor plate for 4 SC duplex couplings
- Dimensions (WxHxD): 265 x 150 x 55 mm
- Colour: light grey (RAL 7035)



Article number	Article designation	PU
<b>Splice Box Compact</b>		
CE9147	Splice Box Compact	1 piece

Photographs are not to scale and do not represent detailed images of the respective products.



## Mini wall-mounted rack



### Product features

- Panel mounting
- Lockable
- Max. capacity of 8 splicing cartridges or 4 splicing cartridges and one distribution plate
- Accessories for Mini wall-mounted rack:
  - Distributor plate for 24 ST couplings
  - Distributor plate for 24 SC Simplex couplings
  - Distributor plate for 12 SC Duplex couplings
- Dimensions (W x H x D): 320 x 280 x 54 mm
- Colour: light grey (RAL 7035)

Article number	Article designation	PU
<b>Mini wall-mounted rack</b>		
CE9150	Mini wall-mounted rack	1 piece
<b>Accessories for Mini wall-mounted rack</b>		
CE9151	Distribution plate for 24 x ST-Couplers	1 piece
CE9152	Distribution plate for 24 x SC-simplex-Couplers	1 piece
CE9153	Distribution plate for 12 x SC-duplex-Couplers	1 piece

Photographs are not to scale and do not represent detailed images of the respective products.



## Accessories for splice boxes and wall-mounted rack



### Product features

- Splicing cassette for up to 2 splicing protection holders
- Cover for splicing cartridge
- 12-fold splicing protection holder
- Splicing protection sleeve for ANT splicing device
- Blind cap instead of E2000 coupling
- Blind cap instead of ST coupling
- Dummy cap instead of SC duplex coupling

Article number	Article designation	PU
<b>Accessories for splice boxes and wall-mounted rack</b>		
CE9914	Splicing cassette for up to 2 splicing protection holders	1 piece
CE9914D	Cover for splicing cartridge	1 piece
CE9916	12-fold splicing protection holder	1 piece
CE9913	Splicing protection sleeve for ANT splicing device	15 pieces
CE9917	Blind cap instead of E2000 coupling	10 pieces
CE9918	Blind cap instead of ST coupling	10 pieces
CE9919	Blind cap instead of SC duplex coupling	10 pieces

Photographs are not to scale and do not represent detailed images of the respective products.



# EPIC®

Industrial connectors

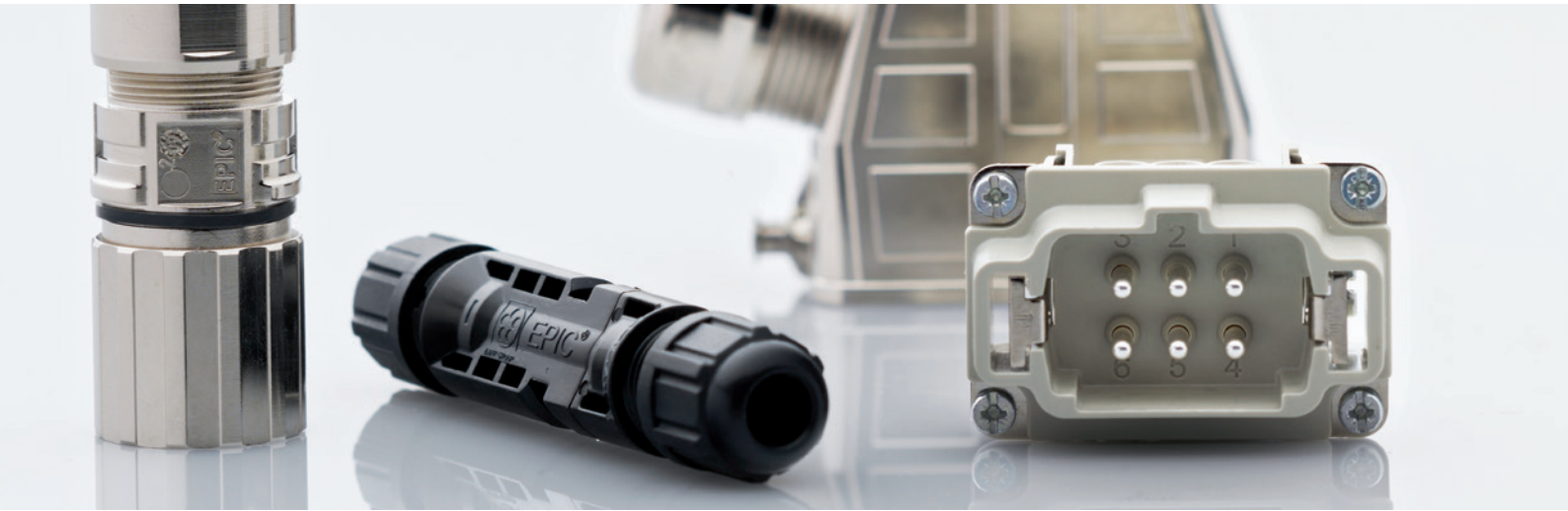

**Product Pages** ..... 256

For current information see [www.lappgroup.com/products](http://www.lappgroup.com/products)



EPIC® M23 Kits 12pol.



Article number	Pieces / PU
<b>EPIC® M23 Kits 12pole</b>	
75009710	1

Article numbers for single components

- E-Part 73002722
- M23 D6 44420037

EPIC® KIT M23 D6 12-POL FEMALE



Article number	Pieces / PU
<b>M23 D6</b>	
75009702	1

Article numbers for single components

- P-part 73002716
- M23 D6 44420037

EPIC® KIT M23 D6 12-POL FEMALE



Article number	Pieces / PU
<b>M23 D6</b>	
75009703	1

Article numbers for single components

- E-Part 73002720
- M23 A1 72004000

EPIC® KIT M23 A1 12-POL MALE



Article number	Pieces / PU
<b>M23 A1</b>	
75009711	1

Article numbers for single components

- P-part 73002714
- M23 A1 72004000

EPIC® KIT M23 A1 12-POL MALE



Article number	Pieces / PU
<b>M23 A1</b>	
25009704	1

Article numbers for single components

- E-Part 73002720
- M23 A3 24420055

EPIC® KIT M23 A3 12-POL MALE



Article number	Pieces / PU
<b>M23 A3</b>	
75009712	1

Article numbers for single components

- P-part 73002714
- M23 A3 24420055

EPIC® KIT M23 A3 12-POL MALE



Article number	Pieces / PU
<b>M23 A3</b>	
75009705	1

Article numbers for single components

- E-Part 73002720
- M23 F6 44420040

EPIC® KIT M23 F6 12-POL MALE



Article number	Pieces / PU
<b>M23 F6</b>	
75009713	1

Article numbers for single components

- P-part 73002714
- M23 F6 44420040

EPIC® KIT M23 F6 12-POL MALE



Info

- Complete connectors - easy to order

Benefits

- Uncomplicated ordering
- No misplaced orders
- Pre-packed kits with compatible components

Technical data

Rated voltage (V)  
100 V (1 mm contacts)

Rated current (A)  
7 A (1 mm contacts)

Number of contacts  
12



**■ EPIC KIT LS1 D6 6-POL FEMALE**



Article number	Pieces / PU
<b>EPIC® LS1 Kits 6pole</b>	
75009690	1

**■ Article numbers for single components**

- LS1 D6 76123000

**■ EPIC KIT LS1 A1 6-POL MALE**



Article number	Pieces / PU
<b>LS1 D6</b>	
75009691	1

**■ Article numbers for single components**

- LS1 A1 76003000

**■ EPIC KIT LS1 A3 6-POL MALE**



Article number	Pieces / PU
<b>LS1 A1</b>	
75009692	1

**■ Article numbers for single components**

- LS1 A3 24420058

**■ EPIC KIT LS1 F6 6-POL MALE**



Article number	Pieces / PU
<b>LS1 A3</b>	
75009693	1

**■ Article numbers for single components**

- LS1 F6 76133000



**Info**

- Complete connectors - easy to order

**■ Benefits**

- Pre-packed kits with compatible components
- Uncomplicated ordering
- No misplaced orders

**■ Technical data**

- Rated voltage (V)**  
630 V (2 mm contacts)
- Rated current (A)**  
26A/3+PE+4, 25A/5+PE  
(2mm contacts)
- Number of contacts**  
5 + PE

**EPIC® LS1 Kits 6pol.**



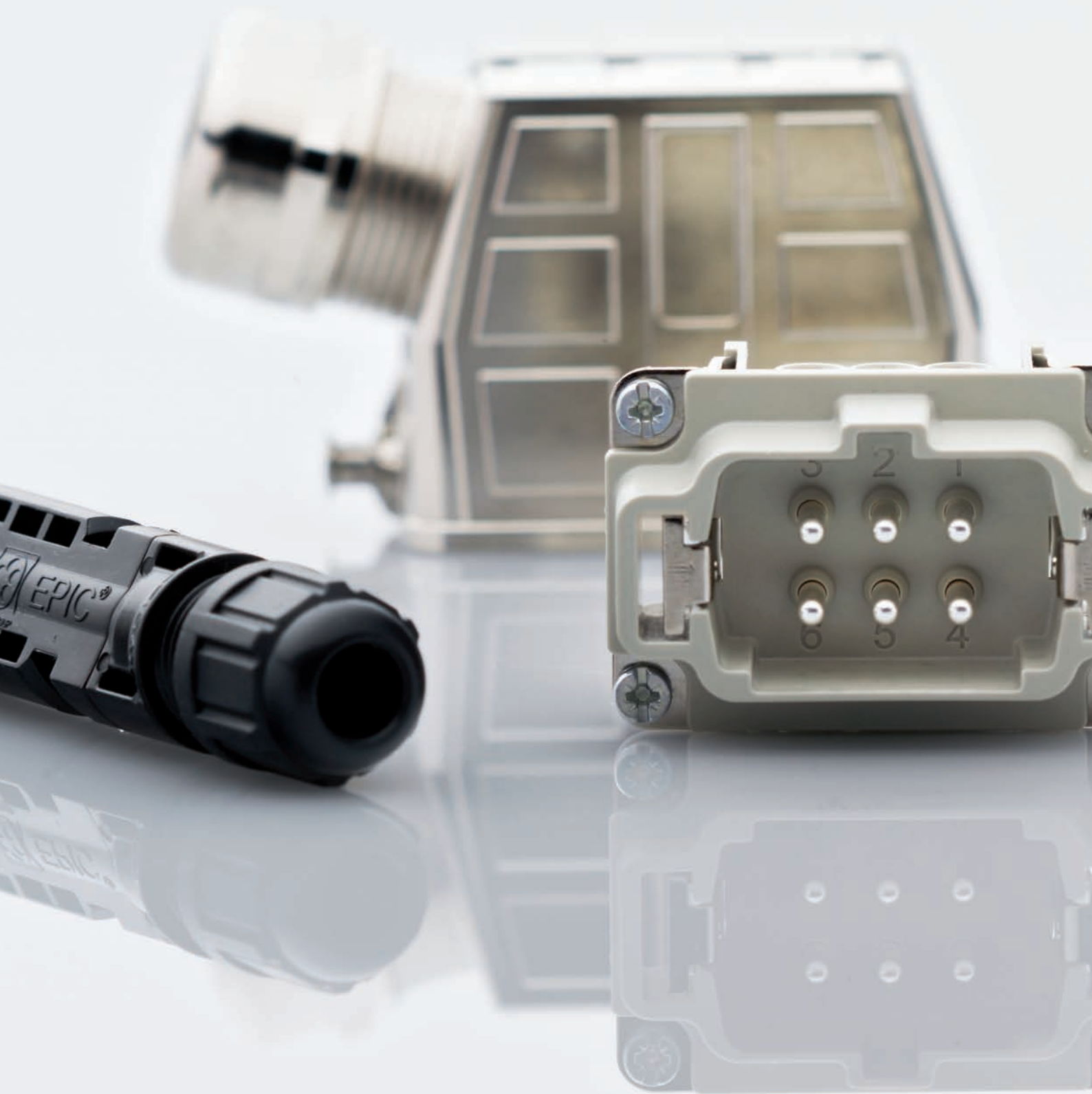



# SKINTOP®

Cable glands



Product Pages ..... 260

For current information see [www.lappgroup.com/products](http://www.lappgroup.com/products)



**New**

**SKINTOP® ST-M / SKINTOP® STR-M**

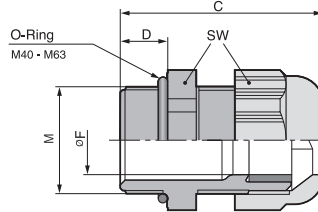

**Info**

- Now with IP 69 K approval! Proven to withstand the most demanding cleaning procedures for industrial machinery with high-pressure cleaners and hot water!

**Benefits**

**SKINTOP® ST-M**

- High oil-resistance for maximum reliability
- Permanent vibration protection
- Wide, variable clamping ranges
- Optimum strain relief
- Various accessories (e.g. multiple sealing inserts)

**SKINTOP® STR-M**

- For the benefits, refer to SKINTOP® ST-M

**Application range**

**SKINTOP® ST-M**

- Used in areas where cables and wires need to be safely inserted into housings
- Machine and equipment manufacturing
- Photovoltaic
- Automation technology
- Offshore platforms, equipment and shipyards

**SKINTOP® STR-M**

- With reducing seal insert, to seal cables with smaller outer diameters.

**Norm references / Approvals**

- UL File Nr. E79903
- GGVS: TÜ.EGG.020-95

**Design**

- Metric connection thread acc. to EN 50262

**Note**

- Refer to SKINTOP® metric accessories for suitable accessories
- Counter nut to be used: SKINTOP® GMP-GL-M
- SKINTOP® ST M ISO types have an extra-long connection thread
- SKINTOP® ST M ISO versions with extra-long connection thread, see table, no DNV approval

**Suitable cables**

- The following cables are recommended for IP 69 K applications:  
ÖLFLEX® ROBUST 200  
H07RN8-F  
H07RN-F

**Suitable tools**

**SKINTOP® ST-M**

- SKINMATIC® QUICK Set 1
- SKINMATIC® RZ
- SKINMATIC® MH Set

**Technical data**

**Classification**  
ETIM 5.0 Class-ID: EC000441

**Caution**  
Refer to Appendix T21 for the installation dimensions and torques

**Colour delivered**  
Silver grey (RAL 7001)  
Light grey (RAL 7035)  
Black (RAL 9005), UV-resistant

**Material**  
Body: Polyamide  
Seal: CR

**Tests**  
GGVS: TÜ.EGG.020-95

**Protection rating**  
IP 68 - 5 bar, 30 min.  
IP 69 K

**Temperature range**  
Fixed: -40°C to +100°C  
Dynamic: -20°C to +100°C

Article number	Article designation / size	Clamping range ØF (mm)	SW (mm)	Overall length, C (mm)	Thread length, D (mm)	Pieces / PU
<b>SKINTOP® ST-M silver grey</b>						
53111000	ST-M 12 x 1,5	3,5-7	15	30,0	8,0	100
53111010	ST-M 16 x 1,5	4,5-10	19	34,0	8,0	100
53111020	ST-M 20 x 1,5	7-13	25	37,0	9,0	100
53111030	ST-M 25 x 1,5	9-17	30	40,0	10,0	50
53111040	ST-M 32 x 1,5	11-21	36	47,0	10,0	25
53111050	ST-M 40 x 1,5	19-28	46	52,0	10,0	10
53111060	ST-M 50 x 1,5	27-35	55	62,0	12,0	5
53111070	ST-M 63 x 1,5	34-45	66	71,0	12,0	5
<b>SKINTOP® ST-M black</b>						
53111200	ST-M 12 x 1,5	3,5-7	15	30,0	8,0	100
53111210	ST-M 16 x 1,5	4,5-10	19	34,0	8,0	100
53111220	ST-M 20 x 1,5	7-13	25	37,0	9,0	100
53111230	ST-M 25 x 1,5	9-17	30	40,0	10,0	50
53111240	ST-M 32 x 1,5	11-21	36	47,0	10,0	25
53111250	ST-M 40 x 1,5	19-28	46	52,0	10,0	10
53111260	ST-M 50 x 1,5	27-35	55	62,0	12,0	5
53111270	ST-M 63 x 1,5	34-45	66	71,0	12,0	5
<b>SKINTOP® ST-M light grey</b>						
53111400	ST-M 12 x 1,5	3,5-7	15	30,0	8,0	100
53111410	ST-M 16 x 1,5	4,5-10	19	34,0	8,0	100
53111420	ST-M 20 x 1,5	7-13	25	37,0	9,0	100
53111430	ST-M 25 x 1,5	9-17	30	40,0	10,0	50
53111440	ST-M 32 x 1,5	11-21	36	47,0	10,0	25
53111450	ST-M 40 x 1,5	19-28	46	52,0	10,0	10
53111460	ST-M 50 x 1,5	27-35	55	62,0	12,0	5
53111470	ST-M 63 x 1,5	34-45	66	71,0	12,0	5
<b>SKINTOP® ST M ISO silver-grey (with long metric connecting thread)</b>						
53017010	ST M 16 x 1,5	3,5-8	19	40,0	12,0	100
53017030	ST M 20 x 1,5	5-12	24	45,0	13,0	100
53017040	ST M 25 x 1,5	9-14	27	47,0	13,0	50

Article number	Article designation / size	Clamping range ØF (mm)	SW (mm)	Overall length, C (mm)	Thread length, D (mm)	Pieces / PU
<b>SKINTOP® ST M ISO black (with long metric connecting thread)</b>						
53010000	ST-M 12 x 1,5	3,5-7	15	36.7	15.0	100
53017210	ST M 16 x 1,5	3,5-8	19	40.0	12.0	100
53017230	ST M 20 x 1,5	5-12	24	45.0	13.0	100
53017240	ST M 25 x 1,5	9-14	27	47.0	13.0	50
<b>SKINTOP® STR-M silver grey</b>						
53111100	STR-M 12 x 1,5	1-5	15	30.0	8.0	100
53111110	STR-M 16 x 1,5	2-7	19	34.0	8.0	100
53111120	STR-M 20 x 1,5	5-10	25	37.0	9.0	100
53111130	STR-M 25 x 1,5	6-13	30	40.0	10.0	50
53111140	STR-M 32 x 1,5	7-15	36	47.0	10.0	25
53111150	STR-M 40 x 1,5	15-23	46	52.0	10.0	10
53111160	STR-M 50 x 1,5	22-29	55	62.0	12.0	5
53111170	STR-M 63 x 1,5	28-39	66	71.0	12.0	5
<b>SKINTOP® STR-M black</b>						
53111300	STR-M 12 x 1,5	1-5	15	30.0	8.0	100
53111310	STR-M 16 x 1,5	2-7	19	34.0	8.0	100
53111320	STR-M 20 x 1,5	5-10	25	37.0	9.0	100
53111330	STR-M 25 x 1,5	6-13	30	40.0	10.0	50
53111340	STR-M 32 x 1,5	7-15	36	47.0	10.0	25
53111350	STR-M 40 x 1,5	15-23	46	52.0	10.0	10
53111360	STR-M 50 x 1,5	22-29	55	62.0	12.0	5
53111370	STR-M 63 x 1,5	28-39	66	71.0	12.0	5
<b>SKINTOP® STR-M light grey</b>						
53111500	STR-M 12 x 1,5	1-5	15	30.0	8.0	100
53111510	STR-M 16 x 1,5	2-7	19	34.0	8.0	100
53111520	STR-M 20 x 1,5	5-10	25	37.0	9.0	100
53111530	STR-M 25 x 1,5	6-13	30	40.0	10.0	50
53111540	STR-M 32 x 1,5	7-15	36	47.0	10.0	25
53111550	STR-M 40 x 1,5	15-23	46	52.0	10.0	10
53111560	STR-M 50 x 1,5	22-29	55	62.0	12.0	5
53111570	STR-M 63 x 1,5	28-39	66	71.0	12.0	5
<b>SKINTOP® STR M ISO silver-grey (with long metric connecting thread)</b>						
53017110	STR M 16 x 1,5	2-6	19	40.0	12.0	100
53017130	STR M 20 x 1,5	4-9	24	45.0	13.0	100
53017140	STR M 25 x 1,5	6-12	27	47.0	13.0	50
<b>SKINTOP® STR M ISO black (with long metric connecting thread)</b>						
53017310	STR M 16 x 1,5	2-6	19	40.0	12.0	100
53017330	STR M 20 x 1,5	4-9	24	45.0	13.0	100
53017340	STR M 25 x 1,5	6-12	27	47.0	13.0	50

Photographs are not to scale and do not represent detailed images of the respective products.

**■ Accessories**

**SKINTOP® ST-M**

- SKINTOP® DIX-M refer to page 266
- SKINTOP® GMP-GL-M
- SKINTOP® DIX-M AUTOMATION refer to page 267
- SKINTOP® SDV-M ATEX
- SKINTOP® SD-M
- SKINTOP® DV-M

**SKINTOP® STR-M**

- SKINTOP® DIX-M refer to page 266
- SKINTOP® GMP-GL-M
- SKINTOP® DIX-M AUTOMATION refer to page 267

ÖLFLEX®

UNITRONIC®

ETHERLINE®

HITRONIC®

EPIC®

SKINTOP®

FLEXIMARK®

APPENDIX





**New**

## SKINTOP® CLICK / SKINTOP® CLICK-R



### ■ Benefits

#### SKINTOP® CLICK

- Fewer parts, counter nut no longer needed
- Save up to 70% of the time with the innovative CLICK system
- Simple, free assembly in any position
- Vibration protection
- No thread required

#### SKINTOP® CLICK-R

- For the benefits, refer to SKINTOP® CLICK

### ■ Application range

#### SKINTOP® CLICK

- Automation technology
- Solar applications
- Control cabinet manufacturing
- Measurement, control and electrical applications
- Air-conditioning technology

#### SKINTOP® CLICK-R

- With reducing seal insert, to seal cables with smaller outer diameters.

### ■ Norm references / Approvals

- UL File Nr. E79903

### ■ Included

- Included: disassembly tool



### Info

- The most innovative cable insertion system in the market for a fast and highly flexible assembly. Simply click in - turn to the left - turn to the right - finished. The result: fixed, centred, strain-relieved fitting and maximum protection class in a few seconds.

### ■ Technical data



#### Classification

ETIM 5.0 Class-ID: EC000441



#### Colour delivered

Silver grey (RAL 7001)  
Light grey (RAL 7035)  
Black (RAL 9005), UV-resistant



#### Material

Body: special polyamide  
Seal: special elastomer



#### Protection rating

**SKINTOP® CLICK**  
IP 68 - 4 bar (M12), 30 min.  
IP 68 - 5 bar (M16 - M32), 30 min.



#### Temperature range

Dynamic: -20°C to +100°C  
Fixed: -40°C to +100°C

Article number	Article designation / size	Clamping range ØF (mm)	M (hole in mm)	SW1/SW2 mm	Overall length, C (mm)	Thread length, D (mm)	Wall thickness, S (mm)	Pieces / PU
<b>SKINTOP® CLICK light grey</b>								
53112692	CLICK 12	3.5 - 7	12.3 (-0.2)	15 / 18	40.0	8.0	1.0 - 4.0	50
53112686	CLICK 16	5 - 9	16.3 (-0.2)	19 / 22	42.0	8.0	1.0 - 4.0	50
53112687	CLICK 20	7 - 13	20.3 (-0.2)	25 / 27	45.5	8.0	1.0 - 4.0	25
53112688	CLICK 25	9 - 17	25.3 (-0.2)	30 / 34	48.5	8.0	1.0 - 4.0	25
53112694	CLICK 32	11 - 21	32.3 (-0.2)	36 / 40	55.0	8.0	1.0 - 4.0	25
<b>SKINTOP® CLICK silver grey</b>								
53112921	CLICK 12	3.5 - 7	12.3 (-0.2)	15 / 18	40.0	8.0	1.0 - 4.0	50
53112876	CLICK 16	5 - 9	16.3 (-0.2)	19 / 22	42.0	8.0	1.0 - 4.0	50
53112877	CLICK 20	7 - 13	20.3 (-0.2)	25 / 27	45.5	8.0	1.0 - 4.0	25
53112878	CLICK 25	9 - 17	25.3 (-0.2)	30 / 34	48.5	8.0	1.0 - 4.0	25
53112922	CLICK 32	11 - 21	32.3 (-0.2)	36 / 40	55.0	8.0	1.0 - 4.0	25
<b>SKINTOP® CLICK black</b>								
53112923	CLICK 12	3.5 - 7	12.3 (-0.2)	15 / 18	40.0	8.0	1.0 - 4.0	50
53112882	CLICK 16	5 - 9	16.3 (-0.2)	19 / 22	42.0	8.0	1.0 - 4.0	50
53112883	CLICK 20	7 - 13	20.3 (-0.2)	25 / 27	45.5	8.0	1.0 - 4.0	25
53112884	CLICK 25	9 - 17	25.3 (-0.2)	30 / 34	48.5	8.0	1.0 - 4.0	25
53112924	CLICK 32	11 - 21	32.3 (-0.2)	36 / 40	55.0	8.0	1.0 - 4.0	25
<b>SKINTOP® CLICK-R light grey</b>								
53112925	CLICK-R 12	1 - 5	12.3 (-0.2)	15 / 18	40.0	8.0	1.0 - 4.0	50
53112689	CLICK-R 16	4 - 7	16.3 (-0.2)	19 / 22	42.0	8.0	1.0 - 4.0	50
53112690	CLICK-R 20	5 - 10	20.3 (-0.2)	25 / 27	45.5	8.0	1.0 - 4.0	25
53112691	CLICK-R 25	6 - 13	25.3 (-0.2)	30 / 34	48.5	8.0	1.0 - 4.0	25
53112926	CLICK-R 32	7 - 15	32.3 (-0.2)	36 / 40	55.0	8.0	1.0 - 4.0	25
<b>SKINTOP® CLICK-R silver grey</b>								
53112927	CLICK-R 12	1 - 5	12.3 (-0.2)	15 / 18	40.0	8.0	1.0 - 4.0	50
53112879	CLICK-R 16	4 - 7	16.3 (-0.2)	19 / 22	42.0	8.0	1.0 - 4.0	50
53112880	CLICK-R 20	5 - 10	20.3 (-0.2)	25 / 27	45.5	8.0	1.0 - 4.0	25
53112881	CLICK-R 25	6 - 13	25.3 (-0.2)	30 / 34	48.5	8.0	1.0 - 4.0	25
53112928	CLICK-R 32	7 - 15	32.3 (-0.2)	36 / 40	55.0	8.0	1.0 - 4.0	25
<b>SKINTOP® CLICK-R black</b>								
53112929	CLICK-R 12	1 - 5	12.3 (-0.2)	15 / 18	40.0	8.0	1.0 - 4.0	50
53112885	CLICK-R 16	4 - 7	16.3 (-0.2)	19 / 22	42.0	8.0	1.0 - 4.0	50
53112886	CLICK-R 20	5 - 10	20.3 (-0.2)	25 / 27	45.5	8.0	1.0 - 4.0	25
53112887	CLICK-R 25	6 - 13	25.3 (-0.2)	30 / 34	48.5	8.0	1.0 - 4.0	25
53112931	CLICK-R 32	7 - 15	32.3 (-0.2)	36 / 40	55.0	8.0	1.0 - 4.0	25

Photographs are not to scale and do not represent detailed images of the respective products.

### ■ Accessories

#### SKINTOP® CLICK

- SKINTOP® DIX-M refer to page 266
- SKINTOP® DIX-M AUTOMATION refer to page 267
- SKINTOP® SDV-M ATEX
- SKINTOP® SD-M
- SKINTOP® DV-M

#### SKINTOP® CLICK-R

- SKINTOP® DIX-M refer to page 266





**SKINTOP® MS-SC-M**

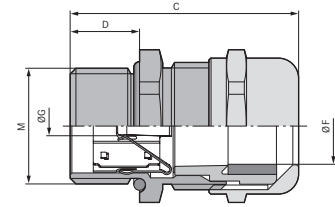

**Benefits**

- Suitable for cables with and without inner sheath
- Also suitable for continuing the cable screen to another connection
- Low-resistance screen contact, optimum EMC protection
- Highly conductive, flexible EMC contact for clamping various screen diameters
- Few operation steps, easy to assemble

**Application range**

- For EMC-compliant earthing of the copper braiding, or for cables with copper shaft sheath
- Telecommunication
- Industrial machinery and plant engineering
- Measurement and control technology
- Automation technology

**Norm references / Approvals**

- UL File Nr. E79903

**Design**

- Metric connection thread acc. to EN 50262

**Note**

- SKINDICHT® SM-PE-M counter nut should be used to ensure optimum contact with painted, anodised or powder-coated housings
- Refer to SKINTOP® metric accessories for suitable accessories
- As an alternative for thick-walled housings, we recommend SKINTOP® MS-SC-M-XL with long connection thread in the sizes M16 to M50

**Technical data**

**Classification**  
ETIM 5.0 Class-ID: EC000441

**Caution**  
Refer to Appendix T21 for the installation dimensions and torques

**Material**  
Body: nickel-plated brass  
Insert: polyamide  
Sealing ring: CR  
O-ring: NBR

**On request**  
In stainless steel V2A available

**Protection rating**  
IP 68 - 10 bar, 30 min.

**Temperature range**  
-30°C to +100°C

Article number	Article designation / size	Outer Ø (mm), from - to	Minimum Ø above braiding (mm)	SW (mm)	Thread length, D (mm)	Pieces / PU
<b>SKINTOP® MS-SC-M</b>						
53112610	12 x 1,5	3.5 - 7.0	2.0	16	6.5	50
53112620	16 x 1,5	4.5 - 9.0	4.0	20	7.0	50
53112630	20 x 1,5	7.0 - 12.5	5.0	24	8.0	25
53112640	25 x 1,5	9.0 - 16.5	7.5	29	8.0	25
53112650	32 x 1,5	11.0 - 21.0	9.0	36	9.0	25
53112660	40 x 1,5	19.0 - 28.0	15.0	45	9.0	10
53112670	50 x 1,5	27.0 - 35.0	21.0	54	10.0	5
<b>SKINTOP® MS-SC-M-XL</b>						
53112625	16 x 1,5	4.5 - 9.0	4.0	20	12.0	50
53112635	20 x 1,5	7.0 - 12.5	5.0	24	12.0	25
53112645	25 x 1,5	9.0 - 16.5	7.5	29	12.0	25
53112655	32 x 1,5	11.0 - 21.0	9.0	36	15.0	25
53112665	40 x 1,5	19.0 - 28.0	15.0	45	15.0	10
53112675	50 x 1,5	27.0 - 35.0	21.0	54	15.0	5

Photographs are not to scale and do not represent detailed images of the respective products.

**Accessories**

- SKINDICHT® SM-PE-M refer to page 270

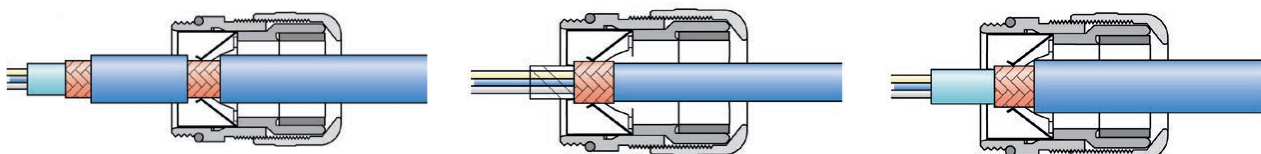



**New**

## SKINTOP® MS-M BRUSH

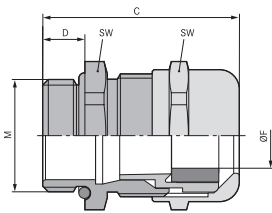

### ■ Benefits

- Faster, easier screen contact
- Optimum, low-resistance 360° screen contact
- Faster than any other comparable system
- Uncomplicated and reliable
- Maximum assembly freedom during adjustment

### ■ Application range

- For EMC-compliant earthing of the copper braiding, or for cables with copper shaft sheath
- Automation systems
- High-power drives
- Frequency converters
- Conveyor and transport systems

### ■ Norm references / Approvals

- UL File Nr. E79903

### ■ Design

- Metric connection thread acc. to EN 50262

### ■ Note

- SKINDICHT® SM-PE-M counter nut should be used to ensure optimum contact with painted, anodised or powder-coated housings



**Info**

- SKINTOP® MS-M BRUSH sizes 75 x 1.5 to 110 x 2 with innovative double lamella gasket for easier assembling of cables with large diameters.

### ■ Technical data



#### Classification

ETIM 5.0 Class-ID: EC000441



#### Caution

Refer to Appendix T21 for the installation dimensions and torques



#### Approvals

VDE, UL, CSA, DNV approval for size M90 x 2 and 110 x 2 pending  
SKINTOP® MSR-M BRUSH 25 x 1,5 approvals pending



#### Material

Body: nickel-plated brass  
EMC brush: brass  
Sealing ring: special elastomer  
O-ring: special elastomer

#### On request

In stainless steel V2A available



#### Protection rating

IP 68 - 10 bar (M12 - M50), 30 min.  
IP 68 - 5 bar (M63), 30 min.  
IP 68 - 1 bar (M63 plus - M75), 30 min.  
IP 69 K (M12 - M63)



#### Temperature range

Dynamic: -30 °C to +100 °C  
Fixed: -40 °C to +100 °C

Article number	Article designation / size	Outer Ø (mm), from - to	Minimum Ø above braiding (mm)	SW (mm)	Thread length, D (mm)	Pieces / PU
<b>SKINTOP® MS-M BRUSH</b>						
53112676	25 x 1,5	9.0 - 17.0	6.0	29	8.0	10
53112677	32 x 1,5	11.0 - 21.0	8.0	36	9.0	1
53112678	40 x 1,5	19.0 - 28.0	10.0	45	9.0	1
53112679	50 x 1,5	27.0 - 35.0	14.0	54	10.0	1
53112680	63 x 1,5	34.0 - 45.0	20.0	67	15.0	1
53112681	63 x 1,5 plus	44.0 - 55.0	25.0	75	15.0	1
53112501	75 x 1,5	53.0 - 63.0	35.0	95	15.0	1
53112500	75 x 1,5 plus	58.0 - 68.0	35.0	95	15.0	1
53112503	90 x 2	66.0 - 78.0	45.0	115	20.0	1
53112505	110 x 2	76.0 - 88.0	55.0	135	25.0	1
53112504	110 x 2 plus	86.0 - 98.0	55.0	135	25.0	1

Photographs are not to scale and do not represent detailed images of the respective products.

### ■ Accessories

- SKINDICHT® SM-PE-M refer to page 270

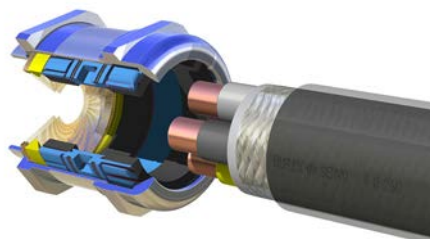



**New**

**SKINTOP® BRUSH ADD-ON**

**Benefits**

- Optimum, low-resistance 360° screen contact
- Cutting edges cut through the insulating layer of the housing or switch cabinets, thus guaranteeing an optimum EMC contact
- Easy disassembling
- Visible, large-scale screen contact
- Uncomplicated and reliable

**Application range**

- For EMC-compliant earthing of the copper braiding, or for cables with copper shaft sheath
- For EMC-contact at through bore-holes
- Control cabinet manufacturing
- Automation systems
- Conveyor and transport systems

**Design**

- Metric connection thread acc. to EN 50262



**Info**

- **Innovative EMC add-on for SKINTOP® ST(R)-M polyamide cable glands.**
- **Worlds first patented active EMC lock-nut!**

**Technical data**



**Classification**

ETIM 5.0 Class-ID: EC000441



**Caution**

Refer to Appendix T21 for the installation dimensions and torques  
Apply SKINTOP® ST-M torques



**Approvals**

UL pending



**Material**

Body: nickel-plated brass  
EMC brush: brass

**On request**

In stainless steel V2A available



**Temperature range**

Dynamic: -20°C to +100°C



Article number	Article designation / size	Minimum Ø above braiding (mm)	SW (mm)	Thread length, D (mm)	Pieces / PU
<b>SKINTOP® BRUSH ADD-ON</b>					
54110839	M 12 x 1,5	4.0	24	10.0	25
54110840	M 16 x 1,5	5.0	24	10.0	25
54110841	M 20 x 1,5	5.0	24	10.0	10
54110842	M 25 x 1,5	5.0	30	10.0	10
54110843	M 32 x 1,5	8.0	39	12.0	10
54110844	M 40 x 1,5	10.0	47	12.0	5
54110845	M 50 x 1,5	14.0	56	12.0	5
54110846	M 63 x 1,5	14.0	63	12.0	5

Photographs are not to scale and do not represent detailed images of the respective products.

**Accessories**

- SKINTOP® BS-M
- SKINTOP® ST-M refer to page 260
- SKINTOP® STR-M refer to page 260
- SKINTOP® ST-HF-M
- SKINTOP® COLD
- SKINTOP® COLD-R





## SKINTOP® DIX-M



### ■ Benefits

- Easy insertion of several cables into one gland
- Higher packing density allows smaller part construction

### ■ Application range

- For use in SKINTOP® cable glands.
- A sealing ring with several holes is used in place of the inner sealing insert.

### ■ Note

- IP 68 can be achieved when all openings are closed and all bores are optimally occupied, i.e. when using cables with nominal diameter and/or SKINTOP® DIX-DV sealing plugs

### ■ Design

- SKINTOP® DIX-M VITON® is resistant to oil, water, alkaline solutions, acids, solvents etc.

### ■ Technical data

	<b>Classification</b> ETIM 5.0 Class-ID: EC000032
	<b>On request</b> Special shapes
	<b>Colour delivered</b> Black, RAL 9005
	<b>Material</b> NBR VITON®
	<b>Protection rating</b> IP 54, 10 min.
	<b>Temperature range</b> -40 °C to +100 °C

Article number	Article designation / size	Size M	Number of cables x cable Ø	Pieces / PU
<b>SKINTOP® DIX-M</b>				
53316220	16,220	M 16	2 x 2.0	100
53316230	16,230	M 16	2 x 3.0	100
53316240	16,240	M 16	2 x 4.0	100
53316420	16,420	M 16	4 x 2.0	100
53320250	20,250	M 20	2 x 5.0	100
53320260	20,260	M 20	2 x 6.0	100
53320340	20,340	M 20	3 x 4.0	100
53320353	20,353	M 20	3 x 5.3	100
53320440	20,440	M 20	4 x 4.0	100
53320920	20,920	M 20	9 x 2.0	100
53320430	20,430	M 20	4 x 3.0	100
53325260	25,260	M 25	2 x 6.0	50
53325250	25,250	M 25	2 x 5.0	50
53325350	25,350	M 25	3 x 5.0	50
53325360	25,360	M 25	3 x 6.0	50
53325370	25,370	M 25	3 x 7.0	50
53325450	25,450	M 25	4 x 5.0	50
53325540	25,540	M 25	5 x 4.0	50
53325640	25,640	M 25	6 x 4.0	50
53332270	32,270	M 32	2 x 7.0	50
53332280	32,280	M 32	2 x 8.0	50
53332290	32,290	M 32	2 x 9.0	50
53332370	32,370	M 32	3 x 7.0	50
53332380	32,380	M 32	3 x 8.0	50
53332460	32,460	M 32	4 x 6.0	50
53332470	32,470	M 32	4 x 7.0	50
53332560	32,560	M 32	5 x 6.0	50
53332650	32,650	M 32	6 x 5.0	50
53332840	32,840	M 32	8 x 4.0	50
53332850	32,850	M 32	8 x 5.0	50
53332940	32,940	M 32	9 x 4.0	50
53340290	40,290	M 40	2 x 9.0	25
53340310	40,310	M 40	3 x 10.0	25
53340480	40,480	M 40	4 x 8.0	25
53340490	40,490	M 40	4 x 9.0	25
53340580	40,580	M 40	5 x 8.0	25
53340590	40,590	M 40	5 x 9.0	25
53340670	40,670	M 40	6 x 7.0	25
53340860	40,860	M 40	8 x 6.0	25
53340969	40,969	M 40	9 x 6.9	25
53350118	50,118	M 50	11 x 8.0	10
53350680	50,680	M 50	6 x 8.0	10
53350780	50,780	M 50	7 x 8.0	10
53350870	50,870	M 50	8 x 7.0	10
53350147	50,147	M 50	14 x 7.0	10
53350164	50,164	M 50	16 x 4.0	10
53350166	50,166	M 50	16 x 6.0	10
<b>SKINTOP® DIX-M VITON®</b>				
53420250	20,250	M 20	2 x 5.0	100
53420260	20,260	M 20	2 x 6.0	100
53440969	40,969	M 40	9 x 6.9	25

Viton® is a registered trademark of DuPont de Nemours  
Photographs are not to scale and do not represent detailed images of the respective products.

### ■ Accessories

- SKINTOP® CLICK refer to page 262
- SKINTOP® ST-M refer to page 260
- SKINTOP® DIX-DV



**New**

## SKINTOP® DIX-M AUTOMATION



### ■ Benefits

- Optimal seal when using AS-I bus cables
- Easy insertion of pre-assembled cables (with fieldbus or RJ-45 connector)
- Strain relief

### ■ Application range

- These seals can be used instead of our standard seals in the SKINTOP® cable glands.
- Control cabinets
- Control panels
- Office applications
- Automation technology

### ■ Note

- IP 68 can be achieved if the hole is optimally occupied, i.e. when using standard AS-I bus cables

### ■ Design

- Precise cut for AS-I bus cables
- Seal with hole and cut for easy insertion of pre-assembled RJ45 network cables
- Seal with hole and cut for easy insertion of pre-assembled field bus cables
- Multiple seal inserts with holes and slits for easy insertion of pre-assembled cables

### ■ Technical data

	<b>Classification</b> ETIM 5.0 Class-ID: EC000032
	<b>Colour delivered</b> Black, RAL 9005
	<b>Material</b> NBR
	<b>Protection rating</b> IP 54, 10 min.
	<b>Temperature range</b> -40°C to +100°C

Article number	Article designation / size	Number of cables x cable Ø	Pieces / PU
<b>SKINTOP® DIX-M ASI</b>			
53611001	M 20	1 x AS-I	50
<b>SKINTOP® DIX-M ASI DUO</b>			
53611004	M 25	2 x AS-I	50
<b>SKINTOP® DIX-M RJ-45</b>			
53440980	M 25	1 x 5.4	50
<b>SKINTOP® DIX-M FIELDBUS</b>			
53440970	M 32	1 x 6.5	50
<b>SKINTOP® DIX-M CUT</b>			
53310444	M 40	3 x 10.0	25

Photographs are not to scale and do not represent detailed images of the respective products.

### ■ Accessories

- SKINTOP® CLICK refer to page 262
- SKINTOP® MS-M
- SKINTOP® ST-M refer to page 260
- SKINTOP® BS-M METAL / SKINTOP® BSR-M METAL





**New**

## SKINTOP® CUBE

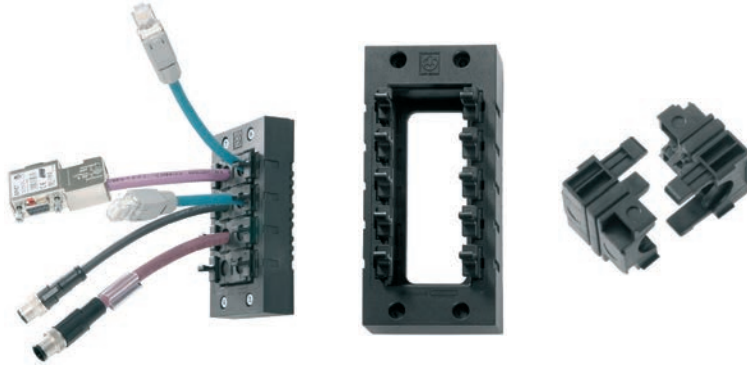

**Info**

- Innovative multi-cable bushing system with variable clamping ranges for high flexibility in assembling.
- When disassembling, the frame can remain on the housing and the plug-in module remains securely on the cable.

**Benefits**

- Variable range of clamping force
- Vibration-safe module fixation
- Strain relief
- Oil resistance
- Simplified servicing due to easy assembling and disassembling

**Application range**

- For installation of harnessed cables
- Used in areas where cables and wires need to be safely inserted into housings
- Apparatus and switch cabinet construction
- Electronic installations
- Automation technology

**Norm references / Approvals**

- UL File Nr. E349737

**Design**

- The SKINTOP® CUBE system consists of the SKINTOP® CUBE FRAME and the clip modules SKINTOP® CUBE MODULE.
- For cut-outs for industrial connectors with standard defined boreholes.
- For cut-outs for 16-pin industrial connectors (36 x 86 mm)
- For cut-outs for 24-pin industrial connectors (36 x 112 mm)

**Note**

- SKINTOP® CUBE MODULE 20x20 BLIND can be used as a blind module and for clamping ranges 1 - 3 mm

**Included**

- SKINTOP® CUBE FRAME including mounting material

**Suitable tools**

- Kraftform Kompakt® 10

**Technical data**



**Classification**

ETIM 5.0 Class-ID: EC000240



**Material**

Frame: glass fibre-reinforced polyamide  
 Frame seal: CR  
 Clip module: special polypropylene  
 Clip module seal: LSE 2



**Protection rating**

IP 64, 10 min.  
 NEMA 12



**Temperature range**

Dynamic: -20°C up to +80°C  
 Static: -40°C up to +80°C

Article number	Article designation / size	Clamping range ØF (mm)	Max. number of executions	Pieces / PU
<b>SKINTOP® CUBE Frame</b>				
52220000	SKINTOP® CUBE FRAME 16		8	1
52220001	SKINTOP® CUBE FRAME 24		10	1
<b>SKINTOP® CUBE clip modules</b>				
52220004	SKINTOP® CUBE MODULE 20x20 BLIND	1 - 3		5
52220002	SKINTOP® CUBE MODULE 20x20 SMALL	4 - 6		5
52220003	SKINTOP® CUBE MODULE 20x20 LARGE	6 - 9		5
52220040	SKINTOP® CUBE MODULE 20x20 AS-I BUS			5
52220005	SKINTOP® CUBE MODULE 40x40 SMALL	9 - 12		5
52220006	SKINTOP® CUBE MODULE 40x40 LARGE	12 - 16		5
52220007	SKINTOP® CUBE MODULE 40x40 BLIND			5

Photographs are not to scale and do not represent detailed images of the respective products.

**Similar products**

- SKINTOP® CUBE MULTI refer to page 269
- SKINDICHT® CABLEFIX cable bushing system

**Accessories**

- FLEXIMARK® LB-10 W







**New**

**SKINTOP® CUBE MULTI**

**Info**

- Push the cable through the gel membrane and connect directly
- Huge potential of savings through quick installation



**Benefits**

- Large, variable clamping ranges by elastic gel technology at the sealing element (innovative membrane technology)
- Easy installation by high packing density
- Optimum strain relief on the entire cable bundle
- Simplified servicing due to easy assembling and disassembling
- Not used holes remain securely sealed

**Application range**

- Used in areas where cables and wires need to be safely inserted into housings
- For installation of not harnessed cables and media hoses
- For cut-outs for 24-pin industrial connectors (36 x 112 mm)
- Apparatus and switch cabinet construction
- Automation technology

**Product features**

- SKINTOP® CUBE MULTI Version 1
- **Number of cable bushings -**  
9 x 3-6 mm clamping range  
9 x 6-9 mm clamping range  
2 x 9-13 mm clamping range  
1 x 13-16 mm clamping range
- SKINTOP® CUBE MULTI Version 2
- **Number of cable bushings -**  
23 x 6-9 mm clamping range

**Design**

- The system consists of SKINTOP® CUBE FRAME and a gel insert SKINTOP® CUBE MULTI.
- Removal of the gel insert by opening the holder

**Note**

- For better strain relief, the cable bundle can be fixed with help of a cable tie

**Included**

- SKINTOP® CUBE FRAME including mounting material

**Technical data**

**Classification**  
ETIM 5.0 Class-ID: EC000240

**Approvals**  
UL pending

**Note**  
Colour: black  
Individual hole configuration available on request

**Material**  
Frame: Glass fiber reinforced polyamide  
Frame seal: CR  
Gel insert: PC / Gel  
Fire behaviour according to UL 94V-2

**Protection rating**  
IP 65  
IP 66

**Temperature range**  
-30°C to +100°C

Article number	Article designation / size	Max. number of executions	Number of cables x clamping range	Pieces / PU
<b>SKINTOP® CUBE Frame</b>				
52220001	SKINTOP® CUBE FRAME 24			1
<b>SKINTOP® CUBE MULTI Gel-insert</b>				
52220050	SKINTOP® CUBE MULTI Version 1	21	9 x 3-6 mm; 9 x 6-9 mm; 2 x 9-13 mm; 1 x 13-16 mm	1
52220053	SKINTOP® CUBE MULTI Version 2	23	23 x 6-9 mm	1
<b>SKINTOP® CUBE MULTI Gel-insert incl. frame</b>				
52220056	SKINTOP® CUBE MULTI Version 1 incl. frame	21	9 x 3-6 mm; 9 x 6-9 mm; 2 x 9-13 mm; 1 x 13-16 mm	1
52220057	SKINTOP® CUBE MULTI Version 2 incl. frame	23	23 x 6-9 mm	1

Photographs are not to scale and do not represent detailed images of the respective products.

**Similar products**

- SKINDICHT® CABLEFIX cable bushing system
- SKINTOP® CUBE

**Accessories**

- Kraftform Kompakt® 10
- FLEXIMARK® LB-10 W

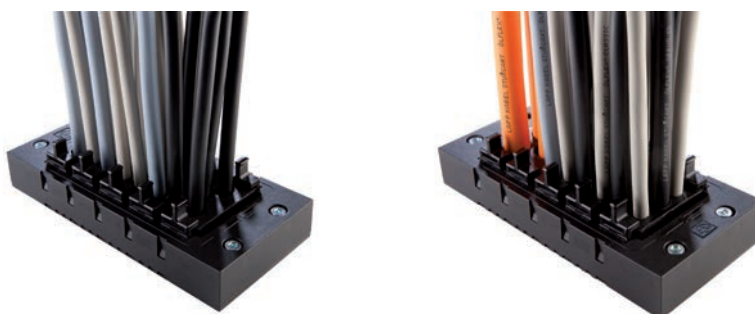



## SKINDICHT® SM-M



### Application range

- Used when a gland has to be countered, or in through-holes on thin-walled housings

### Design

- Metric connection thread acc. to EN 50262

### Technical data

	<b>Classification</b> ETIM 5.0 Class-ID: EC000940
	<b>Material</b> Nickel-plated brass
	<b>Temperature range</b> -20°C to +100°C

Article number	Article designation / size	Thickness (mm)	SW (mm)	Outer Ø (mm)	Pieces / PU
<b>SKINDICHT® SM-M</b>					
52103000	12 x 1,5	3,0	15	16,5	100
52103010	16 x 1,5	3,0	19	20,9	100
52103020	20 x 1,5	3,5	24	26,4	100
52103030	25 x 1,5	4,0	30	33,0	100
52103040	32 x 1,5	4,0	36	39,6	100
52103050	40 x 1,5	5,0	46	50,6	50
52103060	50 x 1,5	5,0	60	65,0	50
52103070	63 x 1,5	5,0	70	77,0	25
52103071	75 x 1,5	8,0	85	95,0	5
52103072	90 x 2	10,0	102	114,0	1
52103073	110 x 2	12,0	124	135,0	1

Photographs are not to scale and do not represent detailed images of the respective products.



## SKINDICHT® SM-PE-M



### Benefits

- Cutting edges cut through the insulating layer, thus guaranteeing an optimum EMC contact
- Suitable for all metric glands used in earthing and EMC applications

### Application range

- For lacquered, anodised or powder-coated housings.

### Design

- Metric connection thread acc. to EN 50262

### Technical data

	<b>Classification</b> ETIM 5.0 Class-ID: EC000940
	<b>Material</b> Nickel-plated brass
	<b>Temperature range</b> -20°C to +100°C

Article number	Article designation / size	Thickness (mm)	SW (mm)	Outer Ø (mm)	Pieces / PU
<b>SKINDICHT® SM-PE-M</b>					
52103300	12 x 1,5	3,5	15	16,5	100
52103310	16 x 1,5	3,5	19	20,9	100
52103320	20 x 1,5	3,7	24	26,4	100
52103330	25 x 1,5	4,2	30	33,0	50
52103340	32 x 1,5	4,7	36	39,6	50
52103350	40 x 1,5	5,5	46	50,6	25
52103360	50 x 1,5	5,5	60	66,0	10
52103370	63 x 1,5	7,0	70	77,0	10
52103371	75 x 1,5	8,0	85	95,0	5
52103372	90 x 2	10,0	102	114,0	1
52103373	110 x 2	12,0	124	135,0	1

Photographs are not to scale and do not represent detailed images of the respective products.













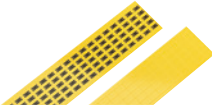







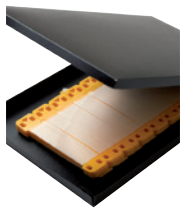



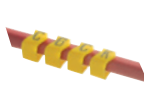

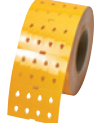







# FLEXIMARK®

Marking systems



Marking Guide ..... 272

















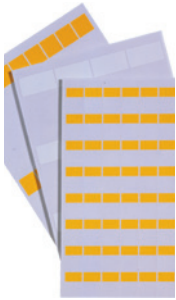

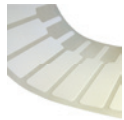
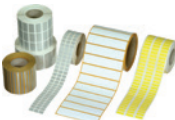



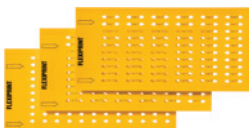

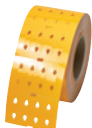





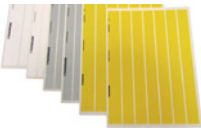

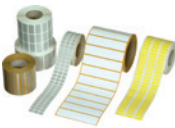
For current information see [www.lappgroup.com/products](http://www.lappgroup.com/products)

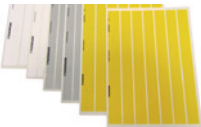
How? What?		Basic system		Customized system			
		Ready made to deliver for each environment		Your demand – we deliver			
Cable	Outdoor & Indoor	 MINI character strips	 Stainless Steel Marking	 Stainless Steel FCC	 Cablelabel FCC		
	Indoor	 Collars	 Marking kit DYMO® PL 150	 Marking tags TMB FCC	 Cablelabel PUR FCC		
Wire	before mounting the wire	 Label cards & Label blocks	 Cablelabel LAM	 Handheld Printers	 Shrink tube FCC	 Cable Marker FCC	
	after mounting the wire	 Marking rings	 Collars	 Flexipart	 Shrink tube FCC	 Flexiprint FCC	 Sleeve FCC
Component	Device marking	 Character holders MLM	 Character holders PGS	 BMK FCC	 Stainless steel component marking FCC		
	Terminal	 Handheld Printers		 Terminal block marking			
	Sensor	 Clip-On collars	 Marking tags TMB FCC	 Marking tags TMB FCC	 Marking tags TMB FCC		
Accessories	 Stainless steel cable ties	 Stainless steel tie gun HT-338	 Pliers FL 52 ERA	 Transparent cover	 Manual embossing machine		

DYMO® is a registered trademark of SANFORD GmbH. Photographs are not to scale and do not represent detailed images of the respective products.



**Data marking**

Laser office printers		Thermal transfer printer	
 <p><b>Flexilabel LFL</b></p>	 <p><b>Labels LMB</b></p>	 <p><b>Flexilabel TFL</b></p>	 <p><b>Cablelabel PUR</b></p>
		 <p><b>Cablelabel MTFL</b></p>	 <p><b>Marking tags TMB</b></p>
 <p><b>Wrapping labels LCK</b></p>	 <p><b>Labels LA/LB</b></p>	 <p><b>Cablelabel LFL</b></p>	 <p><b>Flaglabels</b></p>
			 <p><b>Labels TA</b></p>
			 <p><b>Wrapping labels TCK</b></p>
		 <p><b>Cablelabel TFL</b></p>	 <p><b>Organized shrink tube</b></p>
			 <p><b>Shrink tube</b></p>
 <p><b>Flexiprint LF</b></p>	 <p><b>Labels LMB</b></p>	 <p><b>Flexiprint TF</b></p>	 <p><b>Organized shrink tube</b></p>
			 <p><b>Marking tags TMB</b></p>
 <p><b>Labels LMB</b></p>	 <p><b>Wrapping labels LCK</b></p>	 <p><b>Wrapping labels TCK</b></p>	 <p><b>Marking tags TMB</b></p>
 <p><b>Labels LA/LB</b></p>	 <p><b>Flexilabel LFL</b></p>	 <p><b>Labels TA</b></p>	 <p><b>TA Foam labels</b></p>
			 <p><b>Flexilabel TFL</b></p>
 <p><b>Labels LA/LB</b></p>	 <p><b>Terminal block marking</b></p>	 <p><b>TA Foam labels</b></p>	
 <p><b>Labels LMB</b></p>	 <p><b>Marking tags TMB</b></p>	 <p><b>Marking tags TMB</b></p>	 <p><b>Marking tags TMB</b></p>
 <p><b>FLEXIMARK® SOFTWARE 10.0</b></p> <ul style="list-style-type: none"> <li>- Print your own labels &amp; signs</li> <li>- Work with Excel files</li> <li>- Print barcodes &amp; sequences</li> </ul>		 <p><b>Thermal transfer printer</b></p>	

Photographs are not to scale and do not represent detailed images of the respective products.

I FLEXIMARK



FLEXIMARK



FLEXIMARK





# Appendix



Pin assignments ..... 276

For current information see [www.lappgroup.com/products](http://www.lappgroup.com/products)

### M8 pin assignments (IEC 61076-2-104)

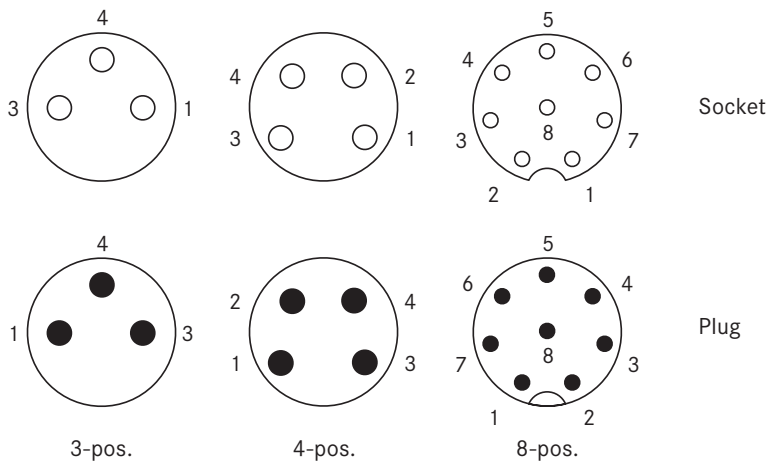

### M12 pin assignments (IEC 61076-2-101)

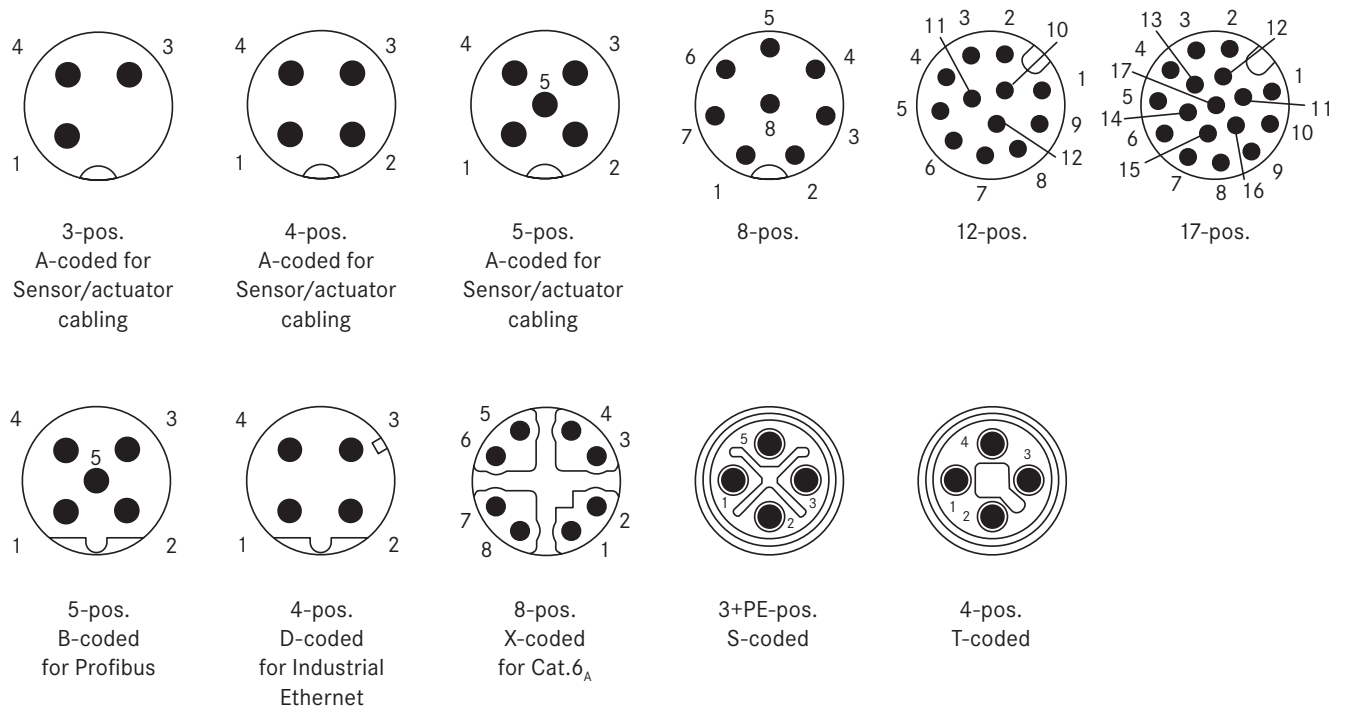

### RJ45 pin assignment (IEC 60603-7-51)

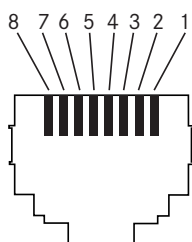

### Connector pin assignments

TIA 568-A	TIA 568-B	PROFINET®	RJ45	M12 D-coded	M12 X-coded	M8
White/Green	White/Orange	Yellow	1	1	1	1
Green	Orange	Orange	2	3	2	4
White/Orange	White/Green	White	3	2	3	2
Blue	Blue	-	4		8	
White/Blue	White/Blue	-	5		7	
Orange	Green	Blue	6	4	4	3
White/Brown	White/Brown	-	7		5	
Brown	Brown	-	8		6	

#### The following applies for the use of our products

The conformity of our products to the relevant European directives and compliance with the provisions contained therein shall be indicated by the CE marking.

The safety of our products is closely associated with how they are used. A knowledge of and adherence to the respective international/national standards of use (e.g. DIN VDE 0100; 0298)

are mandatory. There are particular risks if installed improperly. This applies to all our products/items:

**Processing is only to be done by an authorised electrician! Otherwise, there is the risk of an electric shock or a fire ignited by electric current!**

#### Safety

Without exception, our products are tested for application safety in accordance with defined standards and our own regulations, which complement the standards. Relevant legal requirements and safety regulations are also observed. Provided due care and attention is paid, the possibility of product-specific danger to the user may thus reasonably be excluded. Where products are used carelessly or incorrectly, however, considerable

danger to persons and the environment may arise. For this reason, our cables must only be processed and/or used responsibly by trained electricians or specialists. This catalogue contains general information for the application of each product. Independent of such information, the application standards DIN VDE 0298 and DIN VDE 0891 for cables will apply. Excerpts from these standards, as well as complementary selection

and application tables, design and installation guidelines, are contained in the tables in the appendix to the current main catalogue. Our machines and installation tools are – where necessary – designed in accordance with the machine guidelines and display the CE identification mark. It must be noted, however, that our machines and installation tools must only be used by trained specialist personnel and for the purpose for which they

were designed. ©Copyright by U.I. Lapp GmbH. Reprinting or reproduction of the text or the illustrations may be made only with written approval and with correct indication of source. We reserve the right to make modifications to our products, especially those based on technical improvements or continued development. All illustrations and numerical data etc. are therefore without warranty and are subject to change.

ÖLFLEX®

AVS Stuttgart

UNITRONIC®

ETHERLINE®

HITRONIC®

EPIC®

SKINTOP®

SILVYN®

FLEXIMARK®



11/14.3.000.99.09.02.52

 **LAPP GROUP**

**LAPP HUNGÁRIA Kft.**

2040 Budaörs . Neumann János u. 1.

Tel. +36 23 501 250 . Fax +36 501 259

sales@lapphungaria.hu . www.lapphungaria.hu