

BS4000C

Cable Chains in Bright Zinc Plated Steel

Inner height (D) 104 mm
 Double share link construction.
 Triple-rivet fixing and standard large washer and nylon anti-friction disk to assure smooth and durable movement.
 The strong Alu-covers are un-screwable from both sides.
 Separator systems available.
 Also available in Stainless Steel.

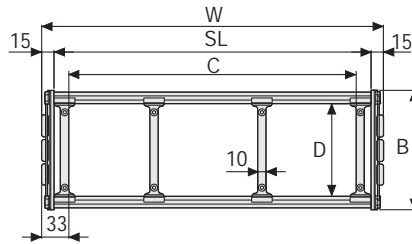

Separator

- Unassembled Part.no S310TCF9
- Assembled Part.no S310TCF9MC

Aluminium Draw Plates with Separators in Nylon

Technical characteristics when self-supported

Speed	0,5 m/s
Acceleration	2 m/s ²

For higher requirements please consult our technical dept.

W	B	C	D	R	Weight/m	Chain
mm	mm	mm	mm	mm	kg	Part Number
216	145	150	104	250-300-350-400-450-500-550-600-700-750-850-1000	24,70	4000C150□□□□*
266	145	200	104	250-300-350-400-450-500-550-600-700-750-850-1000	26,00	4000C200□□□□*
316	145	250	104	250-300-350-400-450-500-550-600-700-750-850-1000	27,40	4000C250□□□□*
366	145	300	104	250-300-350-400-450-500-550-600-700-750-850-1000	28,70	4000C300□□□□*
466	145	400	104	250-300-350-400-450-500-550-600-700-750-850-1000	31,40	4000C400□□□□*
566	145	500	104	250-300-350-400-450-500-550-600-700-750-850-1000	34,10	4000C500□□□□*
C+66	145	104	250-300-350-400-450-500-550-600-700-750-850-1000		4000C □□□□□□**

*Complete the code by inserting the value of the radius (R): Ex. 4000C150 □□□□

**Complete the code by inserting the value of the quote C and the radius (R): Ex. 4000C □□□□□□

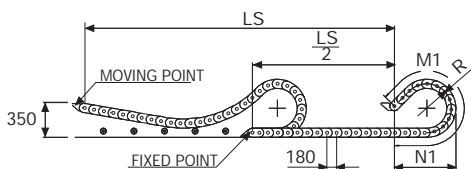
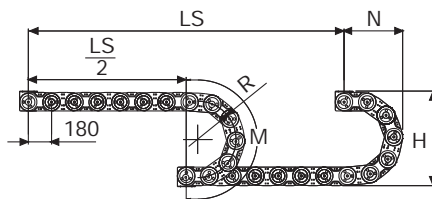

Length of chain (L)
 Half travel distance ($\frac{LS}{2}$)
 plus length of curve (M)

$$L = \frac{LS}{2} + M \text{ or } M1$$

R	H*	N	M	N1	M1
mm	mm	mm	mm	mm	mm
250	670	510	1150	1545	3285
300	770	555	1305	1755	3790
350	870	605	1460	1950	4265
400	970	655	1620	2125	4715
450	1070	710	1780	2295	5150
500	1170	755	1930	2455	5570
550	1270	805	2090	2605	5975
600	1370	855	2245	2755	6375
700	1570	955	2560	3035	7155
750	1670	1010	2720	3170	7535
850	1870	1105	3030	3430	8280
1000	2170	1255	3500	-	-

* The height H should be increased by 10 mm/m approx. because of preload. In case of limitation to the available space, refer to the Technical Dptm.



Self-Supporting Capacity Diagram

The maximum length of the self-supporting capacity ($\frac{LS}{2}$) in relationship to the weight of the cables and hoses contained per linear metre.

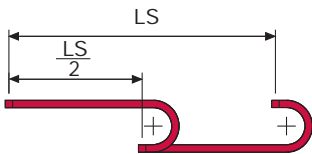
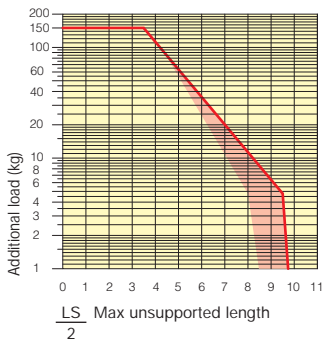

The red marking in the diagram area considers the difference of weight between various widths of chains assembled with aluminium draw plates every second pitch.

For applications with $\frac{LS}{2}$ and weights not included in the area of the diagram showing self-supporting capacity, verify the possible use of support rollers (see page 30).

Bright Zinc Plated Steel End Brackets

The end brackets set, containing four steel plates screwed to the links allows the two ends of the chain to be attached to the equipment.

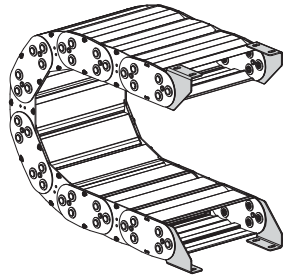
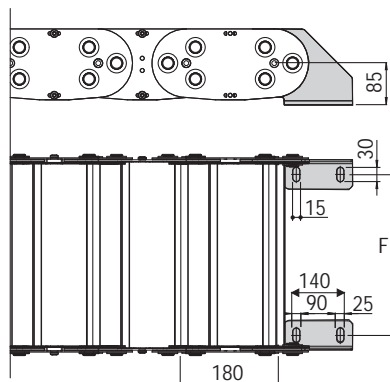

Fig. A
Chain fixed outside the radius. (Fig A)
See end brackets mounting variations page 31.



Chain Type	F mm
BS4000C150	136
BS4000C200	186
BS4000C250	236
BS4000C300	286
BS4000C400	386
BS4000C500	486

Special dimension F=W-80

Bright Zinc Plated Steel Type Part Numbers

Complete Set Assembled	
Chain Type	End Brackets Set
BS4000...	A4000CKM □**

Complete Set Unassembled	
Chain Type	End Brackets Set
BS4000...	A4000CK

** 1=Pos.1; 2=Pos.2; 3=Pos.3
See end brackets mounting variations page 31.

Serie Steel

BS4000C

Cable Chain
in Bright Zinc Plated Steel



Suitable to long travel distance.
See page 195



Supplementary movable separators.

For further information please consult Brevetti Stendalto's Technical Office