

Serie Light

SR30090/91/92 Nylon Cable Chain

Inner height (D) 18,5 mm
Single link construction with central large anti-friction pivot, for high torsion and tensile resistance. Not openable. Used with guide channels, this chain is particularly suitable for long distance travel, as typical for example in larger textile plants.

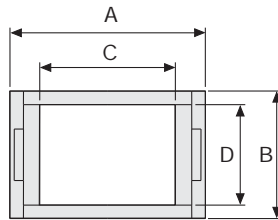

SR30090-SR30091-SR30092

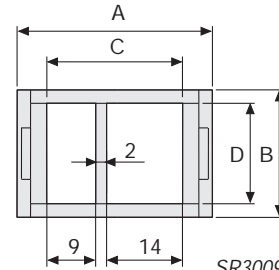

SR30091S

Technical characteristics when self-supported

Speed	10 m/s
Acceleration	50 m/s ²

For higher requirements please consult our technical dept.

A	B	C	D	R	Weight/m	Chain
mm	mm	mm	mm	mm	kg	Part Number
29	23,5	18	18,5	033-038-048-070-100	0,32	SR30090□□□*
36	23,5	25	18,5	033-038-048-070-100	0,36	SR30091□□□*
36	23,5	25	18,5	033-038-048-070-100	0,36	SR30091□□□S*
49	23,5	38	18,5	033-038-048-070-100	0,39	SR30092□□□*

*Complete the code by inserting the value of the radius (R): Ex. SR30090 □ □ □ □ □

For sliding applications, technical data can slightly change according to frequency, added weight and environment.

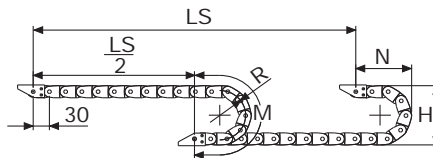

R	H	N	M	N1	M1
mm	mm	mm	mm	mm	mm
033	89,5	75	165	130	275
038	99,5	80	180	130	275
048	119,5	90	210	300	630
070	163,5	112	280	480	1025
100	223,5	145	375	655	1415

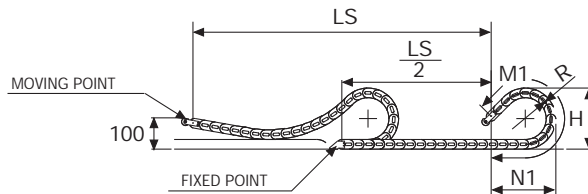

Length of chain (L)
Half travel distance ($\frac{LS}{2}$)
plus length of curve (M) or (M1)

$$L = \frac{LS}{2} + M \text{ or } M1$$



Self-Supporting Capacity Diagram

The maximum length of the self-supporting capacity ($\frac{LS}{2}$) in relationship to the weight of the cables and hoses contained per linear metre.

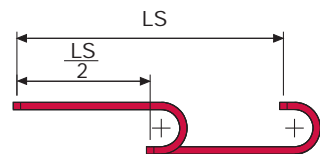
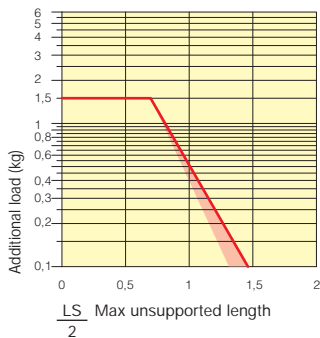

The red marking in the diagram area considers the difference of weight between various widths of chain.

For applications with $\frac{LS}{2}$ and weights not included in the area of the diagram showing self-supporting capacity, verify the possible use of support rollers (see page 30).

Bright Zinc Plated Steel End Brackets*

The end brackets set allows the two ends of the chain to be attached to the equipment.

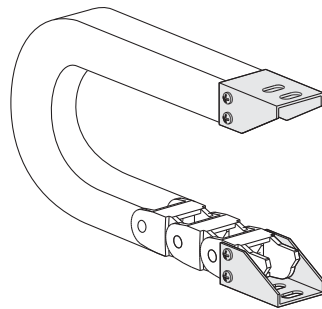
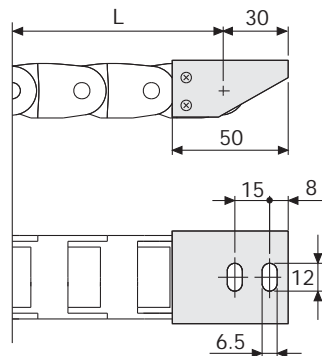

Fig. A
Chain fixed outside the radius. (Fig A)
See end brackets mounting variations page 31.



Bright Zinc Plated Steel Type Part Numbers

Complete Set Assembled	
Chain	End Brackets
Type	Set
SR30090	A30090KM □**
SR30091	A30091KM □**
SR30091S	A30091KM □**
SR30092	A30092KM □**

Complete Set Unassembled	
Chain	End Brackets
Type	Set
SR30090	A30090K □**
SR30091	A30091K □**
SR30091S	A30091K □**
SR30092	A30092K □**

*Available on request in stainless steel
** 1=Pos.1; 2=Pos.2; 3=Pos.3
See end brackets mounting variations page 31.

Serie Light

SR30090
SR30091
SR30092
Nylon Cable Chain

3



Suitable to long travel distance.
To choose the guide channel see page 52

For further information please consult Brevetti Stendalto's Technical Office