

THE COMPLETE
KABELSCHLEPP

Your personal contact

tsubaki-kabelschlepp.com/salesnetwork

Copyright

KABELSCHLEPP® products are constantly enhanced. They are subject to technical changes and assortment changes. Current information on our products can be found at tsubaki-kabelschlepp.com.

Illustrations and text in this catalog are purely informative and, in part, only exemplary. They do not represent any quality guarantee and do not assure suitability for a particular application. This catalog is subject to technical and optical changes. Orders to be placed in the future are subject to the legally agreed quality of the relevant product, or otherwise the quality of each product as it was at the time of the signing of the contract. All rights of this catalog are reserved, including text and illustrations, as well as brand names and corporate logos/trademarks used, in particular the rights of photocopying, distribution, translation or any other form of editing as well as the right of public reproduction.

No part of this catalog, including brand names and corporate logos/trademarks may be reproduced, processed, photocopied or distributed in any form or by any means, especially optical, photo-mechanical, paper-based or electronic, without prior written permission of TSUBAKI KABELSCHLEPP GmbH.

Except hereof is the legally authorized use of photo-copying for merely private purposes (paragraph 53 German copyright law).

Imprint

Editor:
TSUBAKI KABELSCHLEPP GmbH
Daimlerstraße 2, D-57482 Wenden-Gerlingen

Terms and conditions:
Our current terms and conditions of sales and delivery can be found at tsubaki-kabelschlepp.com/gtc

© 2023 · TSUBAKI KABELSCHLEPP GmbH

01	Cable carrier	14
	Cable carrier overview	16
	Selection by inner height	40

02	Cable carrier configuration	42
	Cable carrier design	44
	Stay variants	49
	Divider systems	54
	Connection variants	56
	Strain relief elements	58
	Gliding elements	59
	Multi-band cable carriers	60

03	Configuration guidelines	62
	Selecting a suitable cable carrier	64
	Placement guidelines for cables and hoses	72
	Installation variants	76

04	Materials information	92
	Plastics	94
	Metals	99
	Application temperatures	100
	Tribology	101
	Atex/ESD	102

05	BASIC-LINE	104
	MONO series	106
	QuickTrax® series	126
	UNIFLEX Advanced series	144
	TKP35 series	212
	TKK series	222

06	BASIC-LINE^{PLUS}	232
	EasyTrax® series	234
	PROTUM® series	262

07	VARIO-LINE	298
	K series	300
	UNIFLEX Advanced series	336
	M series	350
	XL series	448
	QUANTUM® series	458
	TKR series	506

08	TUBES-PLASTIC	540
	TKA series	542
	UAT series	574
	MT series	584
	XL series	630

09	3D-LINE	640
	ROBOTRAX® System	642

10	Special solutions	652
	FLATVEYOR®	654
	FLATVEYOR® ZP	658
	CLEANVEYOR®	662

11	STEEL-LINE	666
	LS/LSX series	668
	S/SX series	690

12	TUBES-STEEL	774
	S/SX-Tubes series	776

13	Accessories	804
	Support trays and guide channels	806
	Condition Monitoring	866
	Floating Moving Device (TKFMD)	868
	Support rollers	870
	RSC - Roller Supported Chain	874
	Strain relief devices	876
	Steel band covers	888
	Opening tools	890

14	TRAXLINE®	892
	Cables for Motion	892
	TOTALTRAX®	896

Cable carrier

Cable carrier configuration

Configuration guidelines

Materials information

MONO series

QuickTrax® series

UNIFLEX Advanced series

TKP35 series

TKK series

EasyTrax® series

Cable carrier

Cable carrier
configurationConfiguration
guidelinesMaterials
informationMONO
seriesQuickTrax®
seriesUNIFLEX
Advanced
seriesTKP35
seriesTKK
seriesEasyTrax®
series

Over 65 years of innovations and thousands of realized applications

In 1953, the Waldrich Maschinenfabrik registered a global patent for a steel, unsupported cable carrier to protect moving cables and hoses". The visionary company owner Dr. Oskar Waldrich recognized the invention's potential and established his own subsidiary for the new product in 1954: KABELSCHLEPP. Since this launch, the company has been ensuring the continuous further development of the applications involving this machine component – constantly with new product concepts, innovative materials and extensive customer service.

TSUBAKI KABELSCHLEPP is currently a global player with international representatives and subsidiaries in more than 70 countries and cable carrier systems are a permanent component of almost every machine. Our innovative solutions have proven themselves worldwide in the most diverse industries – and in fact, no longer just in the classical application areas such as machine tools, crane systems, washing lines and medical and laboratory technology, but also in industrial robots, high-sea oil drilling platforms and

space travel. Our experts develop individual products even for complex and unusual fields of usage. In this process, the application defines the material – in addition to steel cable carriers, plastic and hybrid systems are also available. This allows for a wide range of products which can be used for countless applications. There is even an ideal solution for individual challenges – in standard widths or adapted to customer requirements on a millimeter grid. The range of products and accessories comprises over 100,000 variants. These include, for example, strain reliefs, divider systems, channels, hoses, cables, connectors and ready-to-install complete systems.



KABELSCHLEPP and TSUBAKI – together what fits together

TSUBAKI KABELSCHLEPP is integrated into the TSUBAKI Group since 2010 and made responsible for managing the worldwide Cable Carrier Systems business. For more than 50 years, both companies have been close cooperative partners. With this integration, we will leverage our successful working relationship in one strategic enterprise.

This global enterprise offers numerous advantages:

- » An even larger product portfolio to select from
- » Global yet locally supported – vast network of more than 40 international subsidiaries
- » Global manufacturing operations allow for shorter delivery times
- » Combined R&D resources allow for quick and innovative product development

KABELSCHLEPP + TSUBAKI = MORE

MORE Product Solutions

An expanded product portfolio of TSUBAKI products and KABELSCHLEPP cable carrier systems.

MORE Innovations

A combined global R&D with even more resources ensures a quicker response to our customer's needs.

MORE Regional Service

A combined TSUBAKI and KABELSCHLEPP sales force provides added local support. KABELSCHLEPP® products are also now available through the TSUBAKI network of distributors.

MORE Global Support

A unified global sales and support network extends to over 70 countries around the world, providing service and support when and where you need it most.

MORE Value

Together we will continue to prove our reputation as one of the industry's "Best Value" supplier in the industry.

Cable carrier

Cable carrier configuration

Configuration guidelines

Materials information

MONO series

QuickTrax® series

UNIFLEX Advanced series

TKP35 series

TKK series

EasyTrax® series

Cable carrier

Cable carrier
configurationConfiguration
guidelinesMaterials
informationMONO
seriesQuickTrax®
seriesUNIFLEX
Advanced
seriesTKP35
seriesTKK
seriesEasyTrax®
series

Project and development competence

KABELSCHLEPP has been a synonym for innovation since the company was founded. More than 65 years of experience in flexible and efficient development and manufacturing structures make TSUBAKI KABELSCHLEPP a competent partner for customized special solutions and standard products. The demands on development and manufacturing are increasing steadily.

Products are developed worldwide for specific customer and application requirements and form the foundation for our continuously growing experience and technical compe-

tence. In combination with modern simulation tools, test methods and manufacturing processes, this experience allows us to develop efficient development processes – especially for individual project solutions. In close coordination with our customers and their requirements, we optimize all processes for meeting the technical and production requirements as well as factors such as functionality and design of the product. That saves production times and costs.



Tailored customer solutions

Customized cable carriers not only feature innovative technology, they also offer convincing ergonomics and design aspects. DTD (designed to order) – under a separate type designation, TSUBAKI KABELSCHLEPP develops individual

systems for virtually any area of application. Development always focuses on ergonomics, functionality, economic efficiency and customer benefit.

Concept, design and development, project planning

- » Customized solutions based on customer requirements
- » Know-how from the inventor of cable carriers
- » Decades of experience in the development and design of new systems

Design engineering

- » CAD modeling on state-of-the-art systems
- » Simulations and tests on virtual prototypes based on computer-aided model data
- » Calculation and evaluation

Prototyping

- » In-house 3D printing
- » Vacuum casting
- » Additive manufacturing of new systems

Validation, testing

- » Tests on product-specific test benches according to customer specifications
- » State-of-the-art product simulation processes, FMEA and moldflow analyses

Production, assembly

- » Automated individual/series production and assembly
- » Permanent quality control during production and assembly

Cable carrier

Cable carrier configuration

Configuration guidelines

Materials information

MOND series

QuickTrax® series

UNIFLEX Advanced series

TKP35 series

TKK series

EasyTrax® series

Cable carrier

Cable carrier
configurationConfiguration
guidelinesMaterials
informationMONO
seriesQuickTrax®
seriesUNIFLEX
Advanced
seriesTKP35
seriesTKK
seriesEasyTrax®
series

Service that you can rely on

Our service team can design and assemble your cable carrier system even for applications with extreme assembly conditions.

- » Complete assembly with guide channels
- » Uncoiling of harnessed cable carrier systems with long travel lengths
- » Assembly at great heights (e. g. crane systems)

The specialists of our service center provide you with the support that you need. You will see: With TSUBAKI KABELSCHLEPP, you make a decision in favour not only of a cable carrier, but of a totally harmonised system.

Certified Quality Management

We are a reliable partner for a number of industries where special attention is paid to durability and quality. Therefore, we have defined strict requirements for the safety, functionality and performance of our products. Both, internal tests and certificates from independent testing institutes prove that our products and processes comply with these quality standards.





Ecology & Economy

We are advancing the development of environmentally friendly products to conserve the environment and reduce the environmental impact of our operations by improving the efficiency of production activities and developing products that effectively lower energy consumption.

These products help customers reduce energy consumption and improve the economic aspects of their operations. Long-Term objective is to significantly reduce CO₂ emissions.

Further information can be found at tsubaki-kabelschlepp.com



The Tsubaki Eco Link logo is used only on products that satisfy the standards for environmental friendliness set by the Tsubaki Group.

Cable carrier

Cable carrier configuration

Configuration guidelines

Materials information

MONO series

QuickTrax® series

UNIFLEX Advanced series

TKP35 series

TKK series

EasyTrax® series

Cable carrier

Cable carrier

TSUBAKI KABELSCHLEPP supplies steel, highgrade stainless steel and solid plastic cable carriers and plastic cable carriers with aluminium stays (Hybrid cable carriers), in standard sizes or tailor-made to an individual customer's requirements in millimetre units.



- » Solid plastic cable carriers with fixed chain widths
- » Hybrid cable carriers with variable chain widths
- » Covered solid plastic, and hybrid cable carriers
- » Cable carriers for 3D applications
- » Steel cable carriers
- » Covered steel cable carriers

Cables for cable carriers

TRAXLINE® electrical cables were specially developed, optimized and tested for use in cable carrier systems. Even in the most exacting application conditions, they provide the reliability that matters – and at reasonable prices.

- » Control cables
- » Power cables
- » Data cables
- » BUS-/FOC-/Coaxial cables
- » System cables
- » Power One Heavy Duty High voltage cable

Materials information

MONO series

QuickTrax® series

UNIFLEX Advanced series

TKP35 series

TKK series

EasyTrax® series

Ready-to-assemble cable carrier system

Under the name TOTALTRAX® TSUBAKI KABELSCHLEPP supplies complete, fully-harnessed cable carrier systems. According to our customers' requirements we can supply harnessed cable carriers with the cables already inserted up to a full complex system.



- | | | | |
|---|--|---|--|
| <ul style="list-style-type: none"> » Consulting » Planning » Design » Cable carriers » Power- and Control cables » Complete guarantee | <ul style="list-style-type: none"> » Hydraulic hoses » Pneumatic hoses » Plug-and-socket connectors » Assembly plates » Complete assembly of all components | <ul style="list-style-type: none"> » Wall modules » Windows modules » Corner modules » Roof modules » Sliding doors » Folding doors | <ul style="list-style-type: none"> » Lift gates » Roll gates |
|---|--|---|--|

Machine housings

High speeds, quick machining cycles, cooling water and chips: Machine tools represent a dangerous environment for people. This is why all machine tools are contained in nearly „impenetrable“ housings.

Conveyor Systems

For transporting chips / shavings, trimmings, metal scrap, forgings, moulded parts and plastic components KABELSCHLEPP can supply bespoke, client-specific conveyor systems.

- » Conveyor Systems
- » Hinged belt conveyors
- » Scraper conveyors
- » Belt conveyors

Guideway Protection Systems

Fully developed, safe systems that protect guideways, spindles and axles from contamination and damage. Our guideway protection solutions thus avoid expensive down times and facilitate optimal production processes.

- » Telescopic covers
- » Way wipers on guideways
- » Link apron covers
- » Bellows
- » Conical spring covers
- » Roll-up covers



Cable carrier
Cable carrier configuration
Configuration guidelines
Materials information
MOND series
QuickTrax® series
UNIFLEX Advanced series
TKP35 series
TKK series
EasyTrax® series

Industry Solutions

Our cable carrier systems have been deployed successfully in a variety of industries around the world for over 50 years. We now offer Standard applications as customised solutions, tailormade for the individual needs of your industry

ex stock. Your industry sector is not in the list? Get in touch with us directly - our industry experts will be happy to help!



Cable carrier

Cable carrier configuration

Configuration guidelines

Materials information

MONO series

QuickTrax® series

UNIFLEX Advanced series

TKP35 series

TKK series

EasyTrax® series



Steelworks and Rolling Mills

At the hotspot of metallurgy

Glowing workpieces, extreme temperatures, enormous loads – our cable carriers really do hard work in metallurgy. They are robust, heat resistant and lubricant free and protect reliably cables and hoses from the most extreme conditions. Our product range covers almost all possible applications along the value chain of metal production and processing. Hundreds of realized projects in steelworks and rolling mills prove that this is one of our core areas of expertise.



Mining & Drilling

Treasure hunters, watch out!

Thousand of tons of soil need to be moved or hundreds of meters deep need to be drilled to get to the precious mineral resources. Heavy machinery excavates and drills towards the underground deposits. Man and machine must perform at their maximum. These are exactly the extreme conditions where our heavy duty cable carriers are doing their best job. They are robust and durable and protect reliably sensitive cables on heavy machinery while they withstand vibrations, dust and dirt.



Work Platforms & Material Handling Vehicles

We lift you up!

A workplace at lofty heights somewhere between heaven and earth – whether for pruning trees, for maintenance or repair under the roof of a production hall or in firefighting. Special vehicles with lifting technology or telescopic booms take workers up to their extraordinary workplaces. On board: our cable carriers. From lifting to telescopic movements, from movable beams to rotary movements – our products follow smoothly all required movements. At the same time they reliably protect signal and control cables, electric cables and hydraulic hoses.

Up and down – again and again. Lifting, stacking, picking – industrial trucks are indispensable in intralogistics. Our products for guiding cables follow each lifting movement. Our cable carriers are robust and durable and are perfectly designed for such permanent use applications. Different types of forklift trucks ensure all horizontal, in-house transport. No matter which type you use – we support you maintaining your flow of goods.



Agriculture

Not only do we make cows happy...!

Sensors automatically determine how much fertilizer needs to go into the soil. Cows decide themselves when they want to be milked by a milking robot. Modern farming is automated - agriculture has become a high-tech industry. However, the rough operating conditions have remained. Wherever sensitive technology needs to be protected, our cable carriers are in demand. Their fields of application are as diverse as the range of agriculture itself - from milking robots to farm machines, from aquacultures to smart farming.



Furniture Industry

There is no second chance for a first impression

Attractive premises, designed by architects - our cable carriers also have to cut a good figure into interiors. As everyone knows, beauty is in the eye of the beholder. In this case our Protum Office has even convinced the jury's critical eyes - and received the IF Design Award. With its special design it perfectly fits into a tastefully designed environment. Being stylish and functional at the same time it safely holds all cable. Thus, it ensures not only tidiness but also an overall appealing appearance - from designed offices to service desks, from operations centers to media boards in educational institutions.



Telescopes

We'll get you the moon and the stars!

As old as mankind - looking up at the stars. So technologically advanced - looking (and listening) into the endless vastness of space. Only possible with specially developed telescopes. They are the result of intensive cooperation between research institutes and specialist companies.

We have many years of experience in this extremely demanding field between science and technology. Our cable carriers do a fantastic job in many different research institutes across the globe. Whether locking systems for giant domes or precisely aligning parabolic mirrors and optical telescopes through rotating and swiveling - our cable carriers smoothly move these applications containing such highly sensitive technology.



Medical Technology

A clean affair!

Our solutions for clean rooms, especially for medical applications, are a clean affair. Using state-of-the-art technology has become essential in modern medicine - in diagnostics, therapy and care. Meeting highest hygienic standards is top priority.

We offer solutions for a wide range of equipment for imaging diagnostics, for analysis and laboratory equipment, as well as surgery and treatment tables and chairs. Precise alignment, exact positioning or comfortable storage of patients - only possible through multiple, electrical adjustments. Our cable carriers make all this possible: functional, low-vibration, reliable, IP54* certified - and, if desired, with an extra touch of design.

* Refers to type series TKA55 with Bi 50 - 175.

More information on certification: tsubaki-kabelschlepp.com/tka-ip54



Cleanroom

Cleanliness in its pure form

Maximum purity and hygiene! Consistent separation of polluted and clean environment. These are the demanding requirements for producing food and medicinal products. From pharmaceutical industry through medical technology to high-tech industry - all of them require an especially low-particle environment and "technical cleanliness" for their production processes. It comes as no surprise that clean rooms, processes and products are a must! Because any contamination leads to costly incidents, scrap or useless laboratory results.

Our special cleanroom solutions are particularly designed for such hygiene-sensitive production areas. They are abrasion-resistant and low-vibration and thus, keep the number of airborne particles at technically possible minimum. Certified as "cleanroom-suitable", our cable carriers meet all standards of the various cleanroom classes up to cleanroom class 1.



The suitable cable carrier for your application

Find the suitable cable carrier for your specific application with all the relevant information and a direct contact online at tsubaki-kabelschlepp.com/branchen or in our special industry flyers.

Cable carrier

Cable carrier configuration

Configuration guidelines

Materials information

MONO series

QuickTrax® series

UNIFLEX Advanced series

TKP35 series

TKK series

EasyTrax® series

Cable carriers

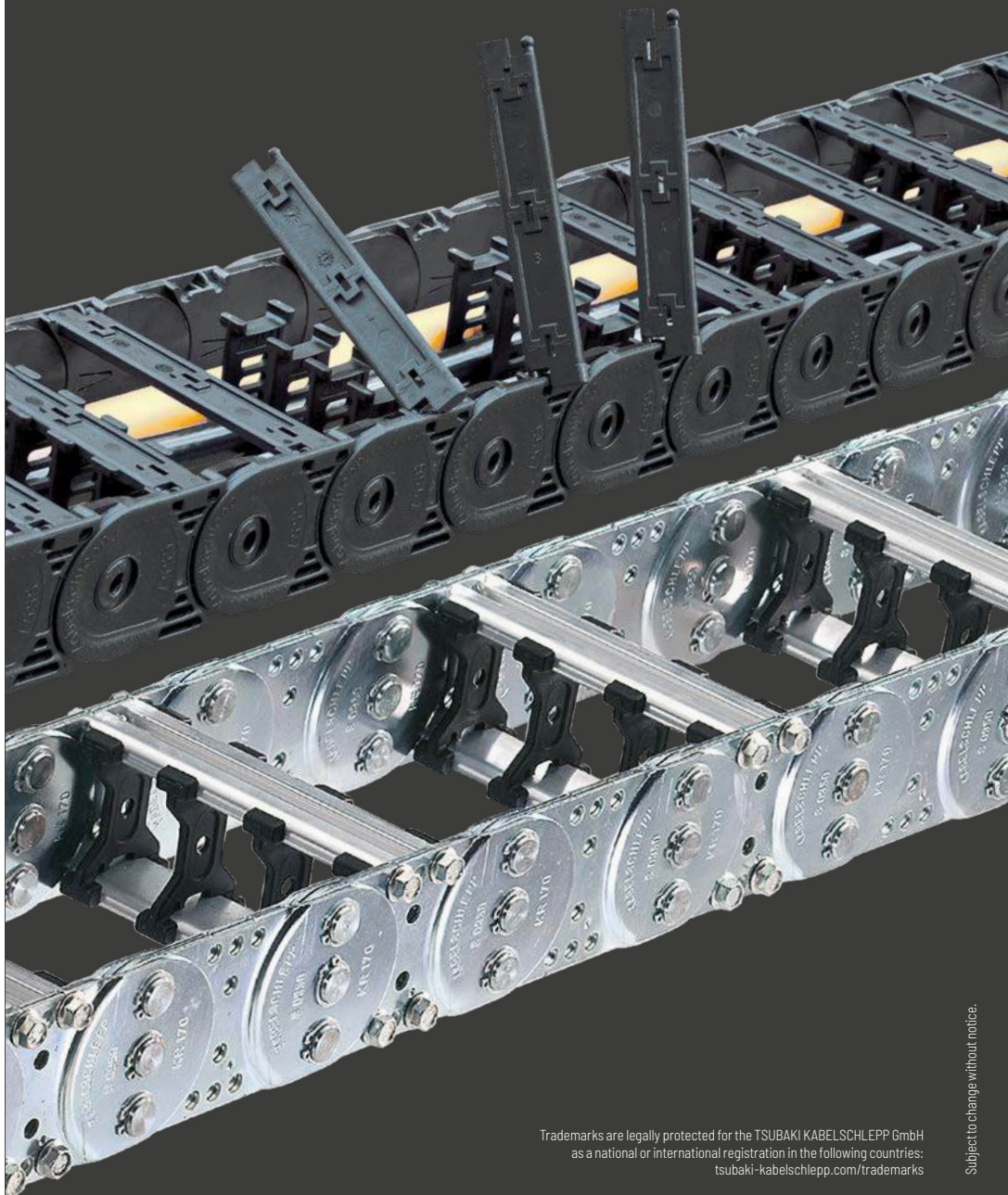

Trademarks are legally protected for the TSUBAKI KABELSCHLEPP GmbH as a national or international registration in the following countries:
tsubaki-kabelschlepp.com/trademarks

Subject to change without notice.

Content

01

























Cable carriers overview Page 16

- » Guideline for fast product selection
- » All series, types and stay variants at a glance

02

Selection by inner height Page 40

- » All cable carrier structured according to inner height

Series	Opening variant	Type	h_i	h_G	B_i	B_k	B_i -grid	t	KR	Additional load ≤ [kg/m]	Cable- d_{max} [mm]
			[mm]	[mm]	[mm]	[mm]	[mm]	[mm]	[mm]		
BASIC-LINE											
MONO series											
		MONO 0132	10	12.5	6-20	12-26	-	13	20-37	0.5	8
		MONO 0130	10	12.5	6-20	12-26	-	13	20-37	0.5	8
		MONO 0134	10	12.5	6-20	12-26	-	13	20-37	0.5	8
		MONO 0182	15	18	10-40	18-48	-	18	28-50	1	12
		MONO 0180	15	18	10-40	18-48	-	18	28-50	1	12
		MONO 0184	15	18	10-40	18-48	-	18	28-50	1	12
	MONO 0202	11	15	6-20	13-27	-	20	18-50	1.25	8.5	
QuickTrax® series											
		QT0250.030	17.6	23	30-50	60	-	25	28-100	4	14
		QT0250.040	17.6	23	30-50	60	-	25	28-100	4	14
		QT0320.030	20	25.5	15-65	27-77	-	32	28-125	3	16
		QT0320.040	20	25.5	15-65	27-77	-	32	28-125	3	16
UNIFLEX Advanced series											
		UA1250.020	17.5	23	30-50	60	-	25	28-100	4	14
		UA1320.020	20	25.5	15-65	27-77	-	32	28-125	3.0	16
		UA1455.020	26	36	25-130	41-146	-	45.5	52-200	6	20.5
		UA1455.030	26	36	25-130	41-146	-	45.5	52-200	6	20.5
		UA1455.040	26	36	25-130	41-146	-	45.5	52-200	6	20.5
		UA1555.020	38	50	50-150	68-168	-	55.5	63-200	10	30
		UA1555.030	38	50	50-150	68-168	-	55.5	63-200	10	30
		UA1555.040	38	50	50-150	68-168	-	55.5	63-200	10	30

Unsupported arrangement			Gliding arrangement			Inner Distribution				Movement			Page
Travel length ≤ [m]	$v_{max} \leq [m/s]$	$a_{max} \leq [m/s^2]$	Travel length ≤ [m]	$v_{max} \leq [m/s]$	$a_{max} \leq [m/s^2]$	TS0	TS1	TS2	TS3	vertical hanging or standing	lying on the side	rotating arrangement	
1.15	10	50	40	3	30	-	-	-	-	•	•	-	112
1.15	10	50	40	3	30	-	-	-	-	•	•	-	113
1.15	10	50	-	-	-	-	-	-	-	•	•	-	114
1.55	10	50	70	3	30	-	-	-	-	•	•	-	118
1.55	10	50	70	3	30	-	-	-	-	•	•	-	119
1.55	10	50	-	-	-	-	-	-	-	•	•	-	120
1.95	10	50	70	3	30	-	-	-	-	•	•	•	124
1.6	10	50	60	3	30	•	•	-	-	•	•	•	134
1.6	10	50	-	-	-	•	•	-	-	•	•	•	135
2.9	10	50	80	2.5	25	•	•	-	-	•	•	•	140
2.9	10	50	-	-	-	•	•	-	-	•	•	•	141
1.6	10	50	60	3	30	•	-	-	-	•	•	•	152
2.9	10	50	80	2.5	25	•	-	-	-	•	•	•	158
4.8	10	50	120	2.5	20	•	-	-	•	•	•	•	164
4.8	10	50	120	2.5	20	•	•	-	•	•	•	•	165
4.8	10	50	-	-	-	•	•	-	•	•	•	•	166
6.3	9	45	125	3	20	•	-	-	•	•	•	•	174
6.3	9	45	125	3	20	•	•	-	•	•	•	•	175
6.3	9	45	-	-	-	•	•	-	•	•	•	•	176

Subject to change without notice.

Cable carrier

Cable carrier configuration

Configuration guidelines

Materials information

MONO series

QuickTrax® series

UNIFLEX Advanced series

TKP35 series

TKK series

EasyTrax® series

Series	Opening variant	Type	h_i	h_G	B_i	B_k	B-grid	t	KR	Additional load \leq [kg/m]	Cable- d_{max} [mm]
			[mm]	[mm]	[mm]	[mm]	[mm]	[mm]	[mm]		

BASIC-LINE

UNIFLEX Advanced series

		UA1665.020	44	60	50 - 250	72 - 272	-	66.5	75 - 300	15	35
		UA1665.030	44	60	50 - 250	72 - 272	-	66.5	75 - 300	15	35
		UA1665.040	44	60	50 - 250	72 - 272	-	66.5	75 - 300	15	35
Materials information		UA1665.RMA	44 (114-189)	60 (170-245)	125 - 200	147 - 222	-	66.5	75 - 300	15	35/151
		UA1775.020	56	77	100 - 400	126 - 276	-	77.5	90 - 340	45	44
		UA1775.030	56	77	100 - 400	126 - 276	-	77.5	90 - 340	45	44
MONO series		UA1775.040	56	77	100 - 400	126 - 276	-	77.5	90 - 340	45	44
		UA1995.020	80	110	85 - 250	115 - 280	-	99.5	150 - 500	50	64
		UA1995.030	80	110	85 - 250	115 - 280	-	99.5	150 - 500	50	64
QuickTrax® series		UA1995.040	80	110	85 - 250	115 - 280	-	99.5	150 - 500	50	64
		UA1995.070	80	110	85 - 250	115 - 280	-	99.5	150 - 500	50	64

TKP35 series

		TKP35.030	32	40	16 - 50	26 - 62	-	35	48 - 125	2	25
		TKP35.040	32	40	25 - 50	37 - 62	-	35	48 - 125	2	25

TKK series

		TKK39.020	39	50	39 - 99	60 - 120	-	39	46 - 95	10	31
		TKK39.040	39	50	39 - 99	60 - 120	-	39	46 - 95	10	31

Unsupported arrangement			Gliding arrangement			Inner Distribution				Movement			Page
Travel length ≤ [m]	V _{max} ≤ [m/s]	a _{max} ≤ [m/s ²]	Travel length ≤ [m]	V _{max} ≤ [m/s]	a _{max} ≤ [m/s ²]	TS0	TS1	TS2	TS3	vertical hanging or standing	lying on the side	rotating arrangement	
7	8	40	150	3	15	•	-	-	•	•	•	•	184
7	8	40	150	3	15	•	•	-	•	•	•	•	185
7	8	40	-	-	-	•	•	-	•	•	•	•	186
7	8	40	150	3	15	•	•	-	•	•	•	-	188
7.8	10	35	200	3	8	•	-	-	•	•	•	•	196
7.8	10	35	200	3	8	•	•	-	•	•	•	•	197
7.8	10	35	200	3	8	•	•	-	•	•	•	•	198
9	10	25	200	8	20	•	-	-	•	•	•	•	204
9	10	25	200	8	20	•	•	-	•	•	•	•	205
9	10	25	200	8	20	•	•	-	•	•	•	•	206
9	10	25	200	8	20	•	•	-	•	•	•	•	207
2.3	5	20	-	-	-	•	•	-	-	•	•	•	218
2.3	5	20	-	-	-	•	•	-	-	•	•	•	219
4.8	3	9	120	2.5	9	•	•	-	-	•	•	•	228
4.8	3	9	-	-	-	•	•	-	-	•	•	•	229

Cable carrier

Cable carrier configuration

Configuration guidelines

Materials information

MONO series

QuickTrax® series

UNIFLEX Advanced series

TKP35 series

TKK series

EasyTrax® series

Series	Opening variant	Type	h_i	h_G	B_i	B_k	B_i - grid	t	KR	Additional load \leq [kg/m]	Cable- d_{max} [mm]
			[mm]	[mm]	[mm]	[mm]	[mm]	[mm]	[mm]		

BASIC-LINE^{PLUS}

EasyTrax[®] series

		ET0115.040	4.6	8	7	11	-	11.5	10	0.4	3.5
		ET0250.030	16.5	23	30-50	60	-	25	28-100	4	13
		ET0250.040	16.5	23	30-50	60	-	25	28-100	4	13
		ET0320.030	18	25.5	15-65	27-77	-	32	28-125	1.2	14
		ET0320.040	18	25.5	15-65	27-77	-	32	28-125	1.2	14
		ET1455.030	25	36	25-78	94	-	45.5	52-200	6	20
		ET1455.040	25	36	25-78	94	-	45.5	52-200	6	20

PROTUM[®] series

		P0240 GS	10	23	50	54	-	24	-	-	8
		P0400 GS	21.5	34	50	55	-	40	-	-	8
		P0400 GS	21.5	53.5	50	55	-	40	-	-	8

Cable carrier

Cable carrier
configurationConfiguration
guidelinesMaterials
informationMONO
seriesQuickTrax[®]
seriesUNIFLEX
Advanced
seriesTKP35
seriesTKK
seriesEasyTrax[®]
series

Unsupported arrangement			Gliding arrangement			Inner Distribution				Movement			Page
Travel length ≤ [m]	$v_{max} \leq [m/s]$	$a_{max} \leq [m/s^2]$	Travel length ≤ [m]	$v_{max} \leq [m/s]$	$a_{max} \leq [m/s^2]$	TS0	TS1	TS2	TS3	vertical hanging or standing	lying on the side	rotating arrangement	
0.68	3	10	-	-	-	-	-	-	-	•	-	-	242
1.6	10	50	60	3	30	•	•	-	-	•	-	•	246
1.6	10	50	-	-	-	•	•	-	-	•	-	•	247
2.9	10	50	80	2.5	25	•	-	-	-	•	-	•	252
2.9	10	50	-	-	-	•	-	-	-	•	-	•	253
4.8	10	50	-	-	-	-	-	-	-	•	-	•	258
4.8	10	50	-	-	-	-	-	-	-	•	-	•	259
-	-	-	-	-	-	-	-	-	-	(•)	-	-	269
-	-	-	-	-	-	-	-	-	-	(•)	-	-	284
-	-	-	-	-	-	-	-	-	-	(•)	-	-	284

Cable carrier

Cable carrier configuration

Configuration guidelines

Materials information

MONO series

QuickTrax® series

UNIFLEX Advanced series

TKP35 series

TKK series

EasyTrax® series

Series	Opening variant	Type	h_i	h_G	B_i	B_k	B_i - grid	t	KR	Additional load \leq [kg/m]	Cable- d_{max} [mm]
			[mm]	[mm]	[mm]	[mm]	[mm]	[mm]	[mm]		

VARIO-LINE

K series

		KC0650 RS	38	57.5	75 - 400	103 - 428	1	65	75 - 300	20	30
		KC0650 LG	36	57.5	75 - 600	103 - 628	1	65	75 - 300	20	32
		KC0650 RMA	38 (200)	57.5 (224)	200 - 400	234 - 428	1	65	75 - 300	20	160
		KE0650 RE	42	57.5	68 - 268	96 - 296	8	65	75 - 300	20	33
		KC0900 RS	58	78.5	100 - 400	131 - 431	1	90	130 - 385	30	46
		KC0900 RV	58	78.5	100 - 500	131 - 531	1	90	130 - 385	30	46
		KC0900 RM	54	78.5	100 - 600	131 - 631	1	90	130 - 385	30	43
		KC0900 LG	50	78.5	100 - 700	131 - 731	1	90	130 - 385	30	42
		KC0900 RMA	58 (200)	78.5 (224)	200 - 500	231 - 531	1	90	130 - 385	30	160
		KC0900 RMR	51	78.5	100 - 600	131 - 631	1	90	130 - 385	30	41
		KE0900 RE	58	78.5	81 - 561	112 - 592	16	90	130 - 385	30	46

UNIFLEX Advanced series

		UA1995 RSH 020	80	110	66 - 600	96 - 630	1	99.5	150 - 500	50	64
		UA1995 RSH 030	80	110	66 - 600	96 - 630	1	99.5	150 - 500	50	64
		UA1995 RSH 040	80	110	66 - 600	96 - 630	1	99.5	150 - 500	50	64
		UA1995 RSH 070	80	110	66 - 600	96 - 630	1	99.5	150 - 500	50	64

* Further information on request.

Unsupported arrangement			Gliding arrangement			Inner Distribution				Movement			Page
Travel length ≤ [m]	v_{max} ≤ [m/s]	a_{max} ≤ [m/s ²]	Travel length ≤ [m]	v_{max} ≤ [m/s]	a_{max} ≤ [m/s ²]	TS0	TS1	TS2	TS3	vertical hanging or standing	lying on the side	rotating arrangement	
										vertical hanging or standing	lying on the side	rotating arrangement	
4.8	8	40	220	2	3	•	•	•	•	•	•	•	306
4.8	8	40	220	2	3	-	-	-	-	•	•	•	310
4.8	8	40	220	2	3	•	-	-	-	•	•	-	312
4.8	8	40	220	2	3	•	•	-	•	•	•	•	314
7.8	6	30	260	2	3	•	•	•	•	•	•	•	320
7.8	6	30	260	2	3	•	•	•	•	•	•	•	324
7.8	6	30	260	2	3	•	•	-	-	•	•	•	*
7.8	6	30	260	2	3	-	-	-	-	•	•	•	328
7.8	6	30	260	2	3	•	-	-	-	•	•	-	330
7.8	6	30	260	2	3	•	-	-	-	•	•	•	*
7.8	6	30	260	2	3	•	•	•	•	•	•	•	332
9	10	25	200	8	20	•	-	-	•	•	•	•	342
9	10	25	200	8	20	•	•	-	•	•	•	•	343
9	10	25	200	8	20	•	•	-	•	•	•	•	344
9	10	25	200	8	20	•	•	-	•	•	•	•	345

Series	Opening variant	Type	h_i	h_G	B_i	B_k	B_i -grid	t	KR	Additional load \leq [kg/m]	Cable- d_{max} [mm]
			[mm]	[mm]	[mm]	[mm]	[mm]	[mm]	[mm]		



VARIO-LINE

M series

		MC0320 RS 01	19	27.5	25 - 280	36 - 291	1	32	37 - 200	2.5	15
		MC0320 RS 02	19	27.5	25 - 280	36 - 291	1	32	37 - 200	2.5	15
		ME0320 RE	19	27.5	25 - 189	36 - 200	4	32	37 - 200	2.5	15
		MK0475 RD 01	28	39	24 - 280	41 - 297	8	47.5	55 - 300	3.0	22
		MK0475 RD 02	28	39	24 - 280	41 - 297	8	47.5	55 - 300	3.0	22
		MC0650 RS	38	57	75 - 400	109 - 434	1	65	75 - 350	25	30
		MC0650 LG	36	57	75 - 500	109 - 534	1	65	75 - 350	25	29
		MC0650 RMA	38 (200)	57 (224)	200 - 400	234 - 434	1	65	75 - 350	25	-
		ME0650 RE	42	57	50 - 266	84 - 300	8	65	75 - 350	25	33
		MK0650 RD	42	57	50 - 266	84 - 300	8	65	75 - 350	25	33
		MC0950 RS	58	80	75 - 400	114 - 439	1	95	140 - 380	35	46
		MC0950 RV	58	80	75 - 500	114 - 539	1	95	140 - 380	35	46
		MC0950 RM	54	80	75 - 600	114 - 639	1	95	140 - 380	35	43
		MC0950 LG	50	80	75 - 600	114 - 639	1	95	140 - 380	35	38
		MC0950 RMA	58 (200)	80 (224)	200 - 500	239 - 539	1	95	140 - 380	35	-
		MC0950 RMR	51	80	75 - 600	114 - 639	1	95	140 - 380	35	46
		ME0950 RE	58	80	45 - 557	84 - 596	16	95	140 - 380	35	46
		MK0950 RD	58	80	45 - 557	84 - 596	16	95	140 - 380	35	46

* Further information on request.

Unsupported arrangement			Gliding arrangement			Inner Distribution				Movement			Page
Travel length ≤ [m]	v_{max} ≤ [m/s]	a_{max} ≤ [m/s ²]	Travel length ≤ [m]	v_{max} ≤ [m/s]	a_{max} ≤ [m/s ²]	TS0	TS1	TS2	TS3	vertical hanging or standing	lying on the side	rotating arrangement	
2.8	10	50	80	2.5	25	•	•	-	-	•	•	•	358
2.8	10	50	80	2.5	25	•	•	-	-	•	•	•	358
2.8	10	50	80	2.5	25	•	•	-	-	•	•	•	360
2.7	10	50	-	-	-	•	•	•	-	•	•	•	366
2.7	10	50	-	-	-	•	•	•	-	•	•	•	368
4.8	10	40	220	8	20	•	•	•	•	•	•	•	374
4.8	10	40	220	8	20	-	-	-	-	•	•	•	378
4.8	10	40	220	8	20	•	-	-	-	•	•	-	380
4.8	10	40	220	8	20	•	•	-	•	•	•	•	382
4.8	10	40	220	8	20	•	•	-	•	•	•	•	383
7.4	10	30	260	8	20	•	•	•	•	•	•	•	392
7.4	10	30	260	8	20	•	•	•	•	•	-	•	396
7.4	10	30	260	8	20	•	•	•	-	•	•	•	400
7.4	10	30	260	8	20	-	-	-	-	•	•	•	402
7.4	10	30	260	8	20	•	-	-	-	•	•	-	404
7.4	10	30	260	8	20	•	-	-	-	•	•	•	406
7.4	10	30	260	8	20	•	•	•	•	•	•	•	408
7.4	10	30	260	8	20	•	•	•	•	•	•	•	409

Subject to change without notice.

Series	Opening variant	Type	h_i	h_G	B_i	B_k	B _i - grid	t	KR	Additional load ≤ [kg/m]	Cable- d _{max} [mm]
			[mm]	[mm]	[mm]	[mm]	[mm]	[mm]	[mm]		

VARIO-LINE

M series

		MC1250 RS	72	96	75 - 400	120 - 445	1	125	180 - 500	65	61
		MC1250 RV	72	96	100 - 600	145 - 645	1	125	180 - 500	65	61
		MC1250 RM	69	96	100 - 800	145 - 845	1	125	180 - 500	65	59
		MC1250 LG	76	96	100 - 800	145 - 845	1	125	180 - 500	65	59
		MC1250 RMA	72 (200)	96 (226)	200 - 800	245 - 845	1	125	180 - 500	65	-
		MC1250 RMR	66	96	100 - 800	145 - 845	1	125	180 - 500	65	54
		ME1250 RE	72	96	71 - 551	116 - 596	16	125	180 - 500	65	61
		MK1250 RD	72	96	71 - 551	116 - 596	16	125	180 - 500	65	61
		MC1300 RMF	87	120	100 - 800	150 - 850	1	130	150 - 500	70	75
		MC1300 RMS	87	120	100 - 800	150 - 850	1	130	150 - 500	70	75
		MC1300 LG	98	120	100 - 800	150 - 850	1	130	150 - 500	70	74

* Further information on request.

Unsupported arrangement			Gliding arrangement			Inner Distribution				Movement			Page
Travel length ≤ [m]	$v_{max} \leq [m/s]$	$a_{max} \leq [m/s^2]$	Travel length ≤ [m]	$v_{max} \leq [m/s]$	$a_{max} \leq [m/s^2]$	TS0	TS1	TS2	TS3	vertical hanging or standing	lying on the side	rotating arrangement	
9.7	10	25	320	8	20	•	•	-	•	•	•	•	418
9.7	10	25	320	8	20	•	•	•	•	•	-	•	422
9.7	10	25	320	8	20	•	•	•	-	•	•	•	426
9.7	10	25	320	8	20	-	-	-	-	•	•	•	428
9.7	10	25	320	8	20	•	-	-	-	•	•	-	430
9.7	10	25	320	8	20	•	-	-	-	•	•	•	432
9.7	10	25	320	8	20	•	•	•	•	•	•	•	434
9.7	10	25	320	8	20	•	•	•	•	•	•	•	435
10.8	10	25	350	8	20	•	•	-	•				442
10.8	10	25	350	8	20	•	•	-	•	•	•	•	444
10.8	10	25	350	8	20	-	-	-	-	•	•	•	446

Cable carrier	
Cable carrier configuration	
Configuration guidelines	
Materials information	
MONO series	
QuickTrax® series	
UNIFLEX Advanced series	
TKP35 series	
TKK series	
EasyTrax® series	

Series	Opening variant	Type	h_i	h_G	B_i	B_k	B_i -grid	t	KR	Additional load \leq [kg/m]	Cable- d_{max} [mm]
			[mm]	[mm]	[mm]	[mm]	[mm]	[mm]	[mm]		



VARIO-LINE

XL series

		XLC1650 RM	108	140	200-1000	268-1068	1	165	250-550	65	86
		XLC1650 LG	110	140	200-1000	268-1068	1	165	250-550	65	88
		XLC1650 RMR	108	140	200-1000	268-1068	1	165	250-550	65	84

QUANTUM® series

		Q040 RE	28	40	28-284	68-324	8	15	60-180	2.5	22
		Q060 RS	38	60	38-500	90-552	1	20	100-300	5	30
		Q060 RE	42	60	68-276	120-328	8	20	100-300	5	33
		Q080 RS	58	80	50-600	122-672	1	25	170-500	8	46
		Q080 RV	58	80	50-600	122-672	1	25	170-500	8	46
		Q080 RE	58	80	58-570	130-642	16	25	170-500	8	46
		Q100 RS	72	98	70-600	152-682	1	30	180-600	12	57
		Q100 RV	72	98	70-600	152-682	1	30	180-600	12	57
		Q100 RE	72	98	74-570	156-652	16	30	180-600	12	57

TKR series

		TKR0150.030	22	27.5	20-60	34-74	-	15	40-75	2	17.5
		TKR0200.030	28	37	40-120	56-136	-	20	55-150	2.5	22
		TKR0260.030	40	54	50-200	76-226	-	26	75-150	8	32
		TKR0280.030	52	66	50-200	80-230	-	28	75-200	10	41
		TKR0370 RE	28	35	40-80	59-99	-	37	55-100	2.4	25

* Further information on request.

** For values > 20 m/s², please contact us, we are happy to advise you.

Unsupported arrangement			Gliding arrangement			Inner Distribution				Movement			Page
Travel length ≤ [m]	v_{max} ≤ [m/s]	a_{max} ≤ [m/s ²]	Travel length ≤ [m]	v_{max} ≤ [m/s]	a_{max} ≤ [m/s ²]	TS0	TS1	TS2	TS3	vertical hanging or standing	lying on the side	rotating arrangement	
11.75	4	25	350	2	2-3	•	-	-	•	•	•	•	454
11.75	4	25	350	2	2-3	-	-	-	-	•	•	•	*
11.75	4	25	350	2	2-3	•	-	-	-	•	•	•	*
3.2	40	300	30	2	3	•	•	•	-	•	•	-	464
5	30	160	50	3	2-3	•	•	•	•	•	•	-	470
5	30	160	50	3	2-3	•	•	-	•	•	•	-	474
6.4	25	100	80	3	2-3	•	•	•	•	•	•	-	480
6.4	25	100	80	3	2-3	•	•	•	•	•	•	-	484
6.4	25	100	80	3	2-3	•	•	•	•	•	•	-	488
7.8	20	70	95	3	2-3	•	•	-	•	•	•	-	494
7.8	20	70	95	3	2-3	•	•	•	•	•	•	-	498
7.8	20	70	95	3	2-3	•	•	•	•	•	•	-	502
1.75	5	200**	-	-	-	•	•	-	-	•	-	-	512
2.75	5	200**	-	-	-	•	•	-	-	•	-	-	518
3.9	5	200**	-	-	-	•	•	-	•	•	-	-	524
4.9	5	200**	-	-	-	•	•	-	•	•	-	-	530
2.8	5	200**	-	-	-	•	•	-	-	•	-	-	536

Subject to change without notice.

Cable carrier

Cable carrier configuration

Configuration guidelines

Materials information

MONO series

QuickTrax® series

UNIFLEX Advanced series

TKP35 series

TKK series

EasyTrax® series

Series	Opening variant	Type	h_i	h_G	B_i	B_k	B-grid	t	KR	Additional load \leq [kg/m]	Cable- d_{max} [mm]
			[mm]	[mm]	[mm]	[mm]	[mm]	[mm]	[mm]		

TUBES-PLASTIC

TKA series

		TKA30.060	20.5	28.5	15 - 65	28 - 78	-	30.5	55 - 180	3	16
		TKA30.080	20.5	28.5	15 - 65	28 - 78	-	30.5	55 - 180	3	16
		TKA38.060	26	36	25 - 130	41 - 146	-	38.5	70 - 230	5	20
		TKA38.080	26	36	25 - 130	41 - 146	-	38.5	70 - 230	5	20
		TKA45.060	36	50	50 - 150	66 - 166	-	45.5	82 - 230	6	28.5
		TKA45.080	36	50	50 - 150	66 - 166	-	45.5	82 - 230	6	28.5
		TKA55.060	45	64	50 - 250	70 - 270	-	55.5	100 - 300	15	36
		TKA55.080	45	64	50 - 250	70 - 270	-	55.5	100 - 300	15	36

UAT series

		UAT1555.080	50	69	75 - 175	Bi + 21	-	55.5	100 - 300	15	40
--	--	--------------------	----	----	----------	---------	---	------	-----------	----	----

MT series

		MT0475 RMD 01	26	39	33 - 180	41 - 197	1	47.5	75 - 300	3	20
		MT0475 RMD 02	26	39	33 - 180	41 - 197	1	47.5	75 - 300	3	20
		MT0475 RDD 01	26	39	24 - 280	41 - 297	8	47.5	75 - 300	3	20
		MT0475 RDD 02	26	39	24 - 280	41 - 297	8	47.5	75 - 300	3	20
		MT0650 RMD	38.5	57	100 - 500	134 - 534	1	65	115 - 350	25	30
		MT0650 RDD	38.5	57	50 - 258	84 - 292	8	65	95 - 350	25	30

Cable carrier
configurationConfiguration
guidelinesMaterials
informationMONO
seriesQuickTrax®
seriesUNIFLEX
Advanced
seriesTKP35
seriesTKK
seriesEasyTrax®
series

Unsupported arrangement			Gliding arrangement			Inner Distribution				Movement			Page			
Travel length ≤ [m]	v_{max} ≤ [m/s]	a_{max} ≤ [m/s ²]	Travel length ≤ [m]	v_{max} ≤ [m/s]	a_{max} ≤ [m/s ²]	TS0	TS1	TS2	TS3	vertical hanging or standing	lying on the side	rotating arrangement				
										•	•	-	•	•	-	548
3.5	10	50	80	2.5	25	•	•	-	-	•	•	-	•	•	-	549
3.5	10	50	80	2.5	25	•	•	-	-	•	•	-	•	•	-	554
3.9	10	50	120	2.5	20	•	•	-	-	•	•	-	•	•	-	555
3.9	10	50	120	2.5	20	•	•	-	-	•	•	-	•	•	-	560
4.7	9	45	125	3	20	•	•	-	•	•	•	-	•	•	-	561
4.7	9	45	125	3	20	•	•	-	•	•	•	-	•	•	-	568
6.5	8	40	150	3	15	•	•	-	•	•	•	-	•	•	-	569
6.5	8	40	150	3	15	•	•	-	•	•	•	-	•	•	-	580
6.5	8	40	150	3	15	•	•	-	-	•	•	-	•	•	-	590
2.7	10	50	-	-	-	•	•	-	-	•	•	-	•	•	-	592
2.7	10	50	-	-	-	•	•	-	-	•	•	-	•	•	-	594
2.7	10	50	-	-	-	•	•	•	-	•	•	-	•	•	-	596
2.7	10	50	-	-	-	•	•	•	-	•	•	-	•	•	-	602
4.8	10	35	170	8	20	•	•	-	-	•	•	-	•	•	-	604
4.8	10	35	170	8	20	•	•	-	-	•	•	-	•	•	-	604

Subject to change without notice.

Series	Opening variant	Type	h_i	h_G	B_i	B_k	B_i -grid	t	KR	Additional load ≤ [kg/m]	Cable- d_{max} [mm]
			[mm]	[mm]	[mm]	[mm]	[mm]	[mm]	[mm]		

TUBES-PLASTIC

MT series

		MT0950 RMD	54.5	80	100 - 600	139 - 639	1	95	200 - 380	35	43
		MT0950 RDD	54.5	80	77 - 349	116 - 388	16	95	140 - 380	35	43
		MT1250 RMD	68.5	96	150 - 800	195 - 845	1	125	260 - 500	65	61
		MT1250 RDD	68.5	96	103 - 359	148 - 404	16	125	220 - 500	65	61
		MT1300 RMD	87	120	100 - 800	150 - 850	1	130	240 - 500	70	69

XLT series

		XLT1650 RMD	105	140	200 - 1000	268 - 1068	1	165	300 - 550	65	84
--	--	-------------	-----	-----	------------	------------	---	-----	-----------	----	----

Series	Opening variant	Type	h_i	B_i	D_a	t	KR	Radial link rotation on 1 m length [°]	Additional load ≤ [kg/m]	Cable- d_{max} [mm]	Page

3D-LINE

ROBOTRAX® System

		R040	10	27	40	21.5	70 [75]	± 450	0.7	8.5	646
		R056	14	39	56	32	90 [105]	± 300	1.1	11	646
		R075	22	52	75	40	125 [140]	± 215	4	18	646
		R085	24	54	85	40	130 [170]	± 215	5	20	646
		R100	31	64	100	40	130 [175]	± 215	6	27	646

Values in [] apply when using protectors

Unsupported arrangement			Gliding arrangement			Inner Distribution				Movement		Page
Travel length ≤ [m]	v_{max} ≤ [m/s]	a_{max} ≤ [m/s ²]	Travel length ≤ [m]	v_{max} ≤ [m/s]	a_{max} ≤ [m/s ²]	TS0	TS1	TS2	TS3	vertical hanging or standing	lying on the side	
7.4	10	25	230	8	20	•	•	•	-	•	•	610
7.4	10	25	230	8	20	•	•	•	•	•	•	612
9.7	10	20	270	8	20	•	•	•	-	•	•	618
9.7	10	20	270	8	20	•	•	•	•	•	•	620
10.8	10	20	300	8	20	•	•	-	•	•	•	626
11.75	4	25	350	2	2-3	•	-	-	•	•	•	636

Series	Opening variant	Type	h_i [mm]	B_i [mm]	D_a [mm]	t [mm]	KR [mm]	Radial link rotation on 1 m length [°]	Additional load ≤ [kg/m]	Cable- d_{max} [mm]	Page

3D-LINE

ROBOTRAX® System

		R140X	48	74	140	50	125 [225]	± 200	10	42	647
--	--	-------	----	----	-----	----	-----------	-------	----	----	-----

Series	Opening variant	Type	h_i	h_G	B_i	B_k	B_i -grid	t	KR	Additional load ≤ [kg/m]	Cable-d _{max} [mm]
			[mm]	[mm]	[mm]	[mm]	[mm]	[mm]	[mm]		

STEEL-LINE

LS/LSX series

		LS/LSX1050 RS 2	58	80	84 - 384	100 - 400	1	105	105 - 430	35	46
		LS/LSX1050 RV	58	80	84 - 584	100 - 600	1	105	105 - 430	35	46
		LS/LSX1050 RR	54	80	84 - 484	100 - 500	1	105	105 - 430	35	43
		LS/LSX1050 LG	48	80	54 - 554	100 - 600	1	105	105 - 430	35	38
		LS/LSX1050 RMA	58 (200)	80 (226)	184 - 384	200 - 400	1	105	105 - 430	35	-

S/SX series

		S/SX0650 RS 1	31	50	65 - 265	100 - 300	1	65	75 - 400	30	24
		S/SX0650 RS 2	31	50	69 - 369	100 - 400	1	65	75 - 400	30	24
		S/SX0650 RR	26	50	69 - 369	100 - 400	1	65	75 - 400	30	20
		S/SX0650 LG	34	50	35 - 465	70 - 500	1	65	75 - 400	30	26
		S/SX0650 RMA	31 (200)	50 (224)	155 - 355	200 - 400	1	65	75 - 400	30	-
		S/SX0950 RS 1	46	68	107 - 257	150 - 300	1	95	125 - 600	45	36
		S/SX0950 RS 2	46	68	113 - 363	150 - 400	1	95	125 - 600	45	36
		S/SX0950 RM	43	68	88 - 563	125 - 600	1	95	125 - 600	45	34
		S/SX0950 RR	42	68	115 - 465	150 - 500	1	95	125 - 600	45	33
		S/SX0950 LG	48	68	82 - 557	125 - 600	1	95	125 - 600	45	38
		S/SX0950 RMR	40	68	108 - 558	150 - 600	1	95	125 - 600	45	32

* Further information on request.

** Depending on the specific application, additional gliding elements or rollers are required.

*** Application-specific, values on request.

Unsupported arrangement			Gliding arrangement			Inner Distribution				Movement			Page
Travel length ≤ [m]	v _{max} ≤ [m/s]	a _{max} ≤ [m/s ²]	Travel length ≤ [m]	v _{max} ≤ [m/s]	a _{max} ≤ [m/s ²]	TS0	TS1	TS2	TS3	vertical hanging or standing	lying on the side	rotating arrangement	
9.5	5	10	-	-	-	•	•	•	•	•	-	-	674
9.5	5	10	-	-	-	•	•	•	•	•	-	-	678
9.5	5	10	-	-	-	•	•	-	-	•	-	-	682
9.5	5	10	-	-	-	-	-	-	-	•	-	-	684
9.5	5	10	-	-	-	•	-	-	-	•	-	-	686
5.8	2.5	5	***	1	2	•	•	-	-	•	•**	•**	700
5.8	2.5	5	***	1	2	•	•	-	-	•	•**	•**	702
5.8	2.5	5	***	1	2	•	•	-	-	•	•**	•**	704
5.8	2.5	5	***	1	2	-	-	-	-	•	•**	•**	706
5.8	2.5	5	***	1	2	•	-	-	-	•	•**	-	*
8.8	2.5	5	***	1	2	•	•	-	-	•	•**	•**	710
8.8	2.5	5	***	1	2	•	•	-	-	•	•**	•**	712
8.8	2.5	5	***	1	2	•	•	-	-	•	•**	•**	714
8.8	2.5	5	***	1	2	•	•	-	-	•	•**	•**	716
8.8	2.5	5	***	1	2	-	-	-	-	•	•**	•**	718
8.8	2.5	5	***	1	2	•	-	-	-	•	•**	•**	*

Cable carrier

Cable carrier configuration

Configuration guidelines

Materials information

MONO series

QuickTrax® series

UNIFLEX Advanced series

TKP35 series

TKK series

EasyTrax® series

Series	Opening variant	Type	h_i	h_G	B_i	B_k	B_i -grid	t	KR	Additional load ≤ [kg/m]	Cable- d_{max} [mm]
			[mm]	[mm]	[mm]	[mm]	[mm]	[mm]	[mm]		

STEEL-LINE

S/SX series



	S/SX1250 RS1	72	94	152 - 352	200 - 400	1	125	145 - 1000	50	57	
	S/SX1250 RS2	72	94	156 - 456	200 - 500	1	125	145 - 1000	50	57	
	S/SX1250 RV	72	94	154 - 554	200 - 600	1	125	145 - 1000	50	57	
	S/SX1250 RM	69	94	151 - 751	200 - 800	1	125	145 - 1000	50	55	
	S/SX1250 RR	66	94	160 - 560	200 - 600	1	125	145 - 1000	50	52	
	S/SX1250 LG	76	94	82 - 752	130 - 800	1	125	145 - 1000	50	59	
	S/SX1250 RMA	72 (200)	94 (226)	154 - 554	200 - 600	1	125	145 - 1000	50	-	
	S/SX1250 RMR	66	94	153 - 753	200 - 800	1	125	145 - 1000	50	52	
	S/SX1800 RM	108	140	188 - 938	250 - 1000	1	180	265 - 1300	60	86	
	S/SX1800 RR	104	140	201 - 751	250 - 800	1	180	265 - 1300	60	83	
	S/SX1800 LG	110	140	121 - 941	180 - 1000	1	180	265 - 1300	60	88	
	S/SX2500 RM	183	220	175 - 1125	250 - 1200	1	250	365 - 1395	100	146	
	S/SX2500 LG	180	220	174 - 1124	250 - 1200	1	250	365 - 1395	100	144	
	S/SX3200 LG	220	300	181 - 1416	250 - 1500	1	320	470 - 1785	150	176	
	S/SX5000	150	200	133 - 1083	250 - 1200	1	200	500 - 1200	100	-	
	S/SX6000	240	300	177 - 1377	300 - 1500	1	320	700 - 1500	150	-	
	S/SX7000	370	450	200 - 1650	350 - 1800	1	450	900 - 2400	600	-	
	S/SX8000	578	600	200 - 1650	350 - 1800	1	550	900 - 2400	800	-	
	S/SX9000	Custom sizes from a cable carrier width of 350 mm									

* Further information on request.

** Depending on the specific application, additional gliding elements or rollers are required.

*** Application-specific, values on request.

Unsupported arrangement			Gliding arrangement			Inner Distribution				Movement			Page
Travel length ≤ [m]	v_{max} ≤ [m/s]	a_{max} ≤ [m/s ²]	Travel length ≤ [m]	v_{max} ≤ [m/s]	a_{max} ≤ [m/s ²]	TS0	TS1	TS2	TS3	vertical hanging or standing	lying on the side	rotating arrangement	
13.5	2.5	5	***	1	2	•	•	-	-	•	**	**	724
13.5	2.5	5	***	1	2	•	•	-	-	•	**	**	728
13.5	2.5	5	***	1	2	•	•	•	•	•	**	**	732
13.5	2.5	5	***	1	2	•	•	•	-	•	**	**	736
13.5	2.5	5	***	1	2	•	•	-	-	•	**	**	738
13.5	2.5	5	***	1	2	-	-	-	-	•	**	**	740
13.5	2.5	5	***	1	2	•	-	-	-	•	**	-	*
13.5	2.5	5	***	1	2	•	-	-	-	•	**	**	*
17.8	2	3	***	0.8	2	•	•	-	•	•	**	**	746
17.8	2	3	***	0.8	2	•	•	-	-	•	**	**	748
17.8	2	3	***	0.8	2	-	-	-	-	•	**	**	750
23.7	1	3	-	-	-	•	•	•	-	•	**	**	756
23.7	1	3	-	-	-	-	-	-	-	•	**	**	758
24	1	2.5	-	-	-	-	-	-	-	•	**	**	762
12	2	3	-	-	-	-	•	-	-	•	**	**	766
16.7	1.5	2	-	-	-	-	•	-	-	•	**	**	767
24.9	0.05	0.3	-	-	-	-	•	-	-	•	**	**	768
24.9	0.05	0.3	-	-	-	-	•	-	-	•	**	**	769
													772

Subject to change without notice.

Cable carrier

Cable carrier configuration

Configuration guidelines

Materials information

MONO series

QuickTrax® series

UNIFLEX Advanced series

TKP35 series

TKK series

EasyTrax® series

Series	Opening variant	Type	h_i	h_G	B_i	B_k	B_i -grid	t	KR	Additional load ≤ [kg/m]	Cable- d_{max} [mm]
			[mm]	[mm]	[mm]	[mm]	[mm]	[mm]	[mm]		

TUBES-STEEL

S/SX Tubes series

	S/SX0650 RMD	30	50	65 - 465	100 - 500	1	65	115 - 300	30	24
	S/SX0950 RMD	44	68	88 - 563	125 - 600	1	95	170 - 600	45	35
	S/SX1250 RMD	69	94	101 - 751	150 - 800	1	125	200 - 1000	50	55
	S/SX1800 RMD	104	140	188 - 938	250 - 1000	1	180	320 - 1405	60	83

* Depending on the specific application, additional gliding elements or rollers are required.

** Application-specific, values on request.

Unsupported arrangement			Gliding arrangement			Inner Distribution				Movement			Page
Travel length ≤ [m]	v_{max} ≤ [m/s]	a_{max} ≤ [m/s ²]	Travel length ≤ [m]	v_{max} ≤ [m/s]	a_{max} ≤ [m/s ²]	TS0	TS1	TS2	TS3	vertical hanging or standing	lying on the side	rotating arrangement	
										vertical hanging or standing	lying on the side	rotating arrangement	
5.8	2.5	5	**	1	2	•	•	-	-	•*	•*	-	782
8.8	2.5	5	**	1	2	•	•	-	-	•*	•*	-	788
13.5	2.5	5	**	1	2	•	•	•	-	•	•	-	794
17.8	2	3	**	0.8	2	•	•	-	•	•	•	-	800

Cable carrier	
Cable carrier configuration	
Configuration guidelines	
Materials information	
MONO series	
QuickTrax® series	
UNIFLEX Advanced series	
TKP35 series	
TKK series	
EasyTrax® series	

Cable carrier | Selection by inner height

h_i [mm]	Cable- d_{max} [mm]	B_i [mm]	Type	Page
4,6 – 10 mm				
4.6	3.5	7	ET0115.040	242
10	8	6 – 20	MONO 0132	112
10	8	6 – 20	MONO 0130	113
10	8	6 – 20	MONO 0134	114
10	8	50	PO240 GS	269
10	8.5	27	RO40	646
11 – 15 mm				
11	8.5	6 – 20	MONO 0202	124
14	11	39	RO56	646
15	12	10 – 40	MONO 0182	118
15	12	10 – 40	MONO 0180	119
15	12	10 – 40	MONO 0184	120
16.5 – 20.5 mm				
16.5	13	20 – 80	ET0250.030	246
16.5	13	20 – 80	ET0250.040	247
17.5	14	20 – 80	UA1250.020	152
17.6	14	20 – 80	QT0250.030	134
17.6	14	20 – 80	QT0250.040	135
18	14	15 – 65	ET0320.030	252
18	14	15 – 65	ET0320.040	253
19	15	25 – 280	MCO320 RS 01	358
19	15	25 – 280	MCO320 RS 02	358
19	15	25 – 189	ME0320 RE	360
20	16	15 – 65	QT0320.030	140
20	16	15 – 65	QT0320.040	141
20	16	15 – 65	UA0320.020	158
20.5	16	15 – 65	TKA30.060	548
20.5	16	15 – 65	TKA30.080	549
21.5	8	50	PO400 GS	284
22 – 30 mm				
22	17.5	20 – 60	TKR0150.030	512
22	18	52	RO75	646
24	20	54	RO85	646
25	20	25 – 78	ET1455.030	258
25	20	25 – 78	ET1455.040	259
26	20.5	25 – 130	UA1455.020	164
26	20.5	25 – 130	UA1455.030	165
26	20.5	25 – 130	UA1455.040	166
26	20	25 – 130	TKA38.060	554
26	20	25 – 130	TKA38.080	555
26	20	33 – 180	MT0475 RMD 1	590
26	20	33 – 180	MT0475 RMD 2	592
26	20	24 – 280	MT0475 RDD 1	594
26	20	24 – 280	MT0475 RDD 2	596
26	20	69 – 369	S/SX0650 RR	704
28	22	24 – 280	MK0475 RD 1	366

h_i [mm]	Cable- d_{max} [mm]	B_i [mm]	Type	Page
28	22	24 – 280	MK0475 RD 2	368
28	22	28 – 284	Q040 RE	464
28	22	40 – 120	TKR0200.030	518
28	22	40 – 80	TKR0370 RE	536
30	24	65 – 465	S/SX0650 RMD	782
31 – 40 mm				
31	27	64	R100	646
31	24	65 – 265	S/SX0650 RS 1	700
31	24	69 – 369	S/SX0650 RS 2	702
32	25	16 – 50	TKP35.030	218
32	25	25 – 50	TKP35.040	219
36	32	75 – 600	KC0650 LG	310
36	29	75 – 600	MCO650 LG	378
36	28.5	50 – 150	TKA45.060	560
36	28.5	50 – 150	TKA45.080	561
36	26	35 – 465	S/SX0650 LG	706
38	30	50 – 150	UA1555.020	174
38	30	50 – 150	UA1555.030	175
38	30	50 – 150	UA1555.040	176
38	30	75 – 400	KC0650 RS	306
38	30	75 – 400	MCO650 RS	374
38	30	38 – 500	Q060 RS	470
38.5	30	100 – 500	MT0650 RMD	602
38.5	30	50 – 258	MT0650 RDD	604
39	31	39 – 99	TKK39.020	228
39	31	39 – 99	TKK39.040	229
40	32	50 – 200	TKR0260.030	524
40	32	108 – 558	S/SX0950 RMR	*
42 – 48 mm				
42	33	68 – 268	KE0650 RE	314
42	33	50 – 266	ME0650 RE	382
42	33	50 – 266	MK0650 RD	383
42	33	68 – 276	Q060 RE	474
42	33	115 – 465	S/SX0950 RR	716
43	34	88 – 563	S/SX0950 RM	714
44	35	50 – 250	TKA65.020	184
44	35	50 – 250	UA1665.030	185
44	35	50 – 250	UA1665.040	186
44	35	88 – 563	S/SX0950 RMD	788
45	36	50 – 250	TKA65.060	568
45	36	50 – 250	TKA65.080	569
46	36	107 – 257	S/SX0950 RS 1	710
46	36	113 – 363	S/SX0950 RS 2	702
47	42	126.5	R140	647
48	38	82 – 582	LS/LSX1050 LG	684

Cable carrier | Selection by inner height

h_i [mm]	Cable- d_{max} [mm]	B_i [mm]	Type	Page

50 - 58 mm				
50	42	100 - 700	KC0900 LG	328
50	38	75 - 600	MC0950 LG	402
50	40	75 - 175	UAT1555.080	580
48	38	82 - 557	S/SX0950 LG	718
51	41	100 - 600	KC0900 RMR	*
51	46	75 - 600	MC0950 RMR	406
52	41	50 - 200	TKR0280.030	530
54	43	100 - 600	KC0900 RM	*
54	43	75 - 600	MC0950 RM	400
54	43	84 - 484	LS/LSX1050 RR	682
54.5	43	100 - 600	MT0950 RMD	610
54.5	43	77 - 349	MT0950 RDD	612
56	44	100 - 400	UAI775.020	196
56	44	100 - 400	UAI775.030	197
56	44	100 - 400	UAI775.040	198
58	46	100 - 400	KC0900 RS	320
58	46	100 - 500	KC0900 RV	324
58	46	81 - 561	KE0900 RE	332
58	46	75 - 400	MC0950 RS	392
58	46	75 - 500	MC0950 RV	396
58	46	45 - 557	ME0950 RE	408
58	46	45 - 557	MK0950 RD	409
58	46	50 - 600	Q080 RS	480
58	46	50 - 600	Q080 RV	484
58	46	58 - 570	Q080 RE	488
58	46	84 - 384	LS/LSX1050 RS2	674
58	46	84 - 584	LS/LSX1050 RV	678

60 - 80 mm				
66	54	100 - 800	MC1250 RMR	432
66	52	160 - 560	S/SX1250 RR	738
66	52	153 - 753	S/SX1250 RMR	*
68.5	61	150 - 800	MT1250 RMD	618
68.5	61	103 - 359	MT1250 RDD	620
69	59	100 - 800	MC1250 RM	426
69	55	151 - 751	S/SX1250 RM	736
69	55	101 - 751	S/SX1250 RMD	794
72	61	75 - 400	MC1250 RS	418
72	61	100 - 600	MC1250 RV	396
72	61	71 - 551	ME1250 RE	434
72	61	71 - 551	MK1250 RD	435
72	57	70 - 600	Q100 RS	494
72	57	70 - 600	Q100 RV	498
72	57	74 - 570	Q100 RE	502
72	57	152 - 352	S/SX1250 RS1	724
72	57	156 - 456	S/SX1250 RS2	728
72	57	154 - 554	S/SX1250 RV	732
74	59	100 - 800	MC1250 LG	428
76	59	82 - 752	S/SX1250 LG	740

h_i [mm]	Cable- d_{max} [mm]	B_i [mm]	Type	Page

80	64	85 - 400	UA1995.020	204
80	64	85 - 400	UA1995.030	205
80	64	85 - 250	UA1995.040	206
80	64	85 - 250	UA1995.070	207
80	64	66 - 600	UA1995 RSH 020	342
80	64	66 - 600	UA1995 RSH 030	343
80	64	66 - 600	UA1995 RSH 040	344
80	64	66 - 600	UA1995 RSH 070	345

87 - 108 mm				
87	75	100 - 800	MC1300 RMF	442
87	75	100 - 800	MC1300 RMS	444
87	69	100 - 800	MT1300 RMD	626
92	74	100 - 800	MC1300 LG	446
104	83	201 - 751	S/SX1800 RR	748
104	83	188 - 938	S/SX1800 RMD	800
105	84	200 - 1000	XLT1650 RMD	636
108	86	200 - 1000	XLC1650 RM	454
108	84	200 - 1000	XLC1650 RMR	*
108	86	188 - 938	S/SX1800 RM	746

110 - 220 mm				
110	88	200 - 1000	XLC1650 LG	*
110	88	121 - 941	S/SX1800 LG	750
110	-	133 - 1083	S/SX5000 RSV	766
180	144	174 - 1124	S/SX2500 LG	758
183	146	175 - 1125	S/SX2500 RM	756
189	151	125 - 200	UA1665 RMA	188
200	160	200 - 400	KC0650 RMA	312
200	160	200 - 500	KC0900 RMA	330
200	-	200 - 400	MC0650 RMA	380
200	-	200 - 500	MC0950 RMA	404
200	-	200 - 800	MC1250 RMA	430
200	-	184 - 384	LS/LSX1050 RMA	686
200	-	155 - 355	S/SX0650 RMA	*
200	-	154 - 554	S/SX1250 RMA	*
220	176	166 - 1416	S/SX3200 LG	762

240 - 578 mm				
240	-	177 - 1377	S/SX6000 RSV	767
370	-	200 - 1650	S/SX7000 RSV	768
578	-	200 - 1650	S/SX8000 RSV	769

* Further information on request.

Cable carrier

Cable carrier configuration

Configuration guidelines

Materials information

MONO series

QuickTrax® series

UNIFLEX Advanced series

TKP35 series

TKK series

EasyTrax® series

Cable carrier configuration



Brands of TSUBAKI KABELSCHLEPP GmbH are protected as national or international trademarks in the following countries:
tsubaki-kabelschlepp.com/trademarks

Subject to change without notice.

Content

01	Cable carrier design page 44 <ul style="list-style-type: none"> » Solid plastic, hybrid and steel cable carriers » Pitch and inner height as characteristic parameters for cable carriers » Explanation of KR and RKR as well as KR/RKR
02	Stay variants page 49 <ul style="list-style-type: none"> » Overview » Opening options » Explanation of fully stayed and half-stayed
03	Divider systems page 54 <ul style="list-style-type: none"> » Overview » Explanation of the systems TS0, TS1, TS2, TS3 and LG
04	Connection variants page 56 <ul style="list-style-type: none"> » Explanation of UMB, plastic end connectors and steel end connectors » Connection variants
05	Strain relief elements page 58 <ul style="list-style-type: none"> » Overview and explanation of strain relief options
06	Gliding elements page 59 <ul style="list-style-type: none"> » Use of glide shoes
07	Multi-band cable carriers page 60 <ul style="list-style-type: none"> » Area of application for multi-band cable carriers

Cable carrier

Cable carrier configuration

Configuration guidelines

Materials information

MONO series

QuickTrax® series

UNIFLEX Advanced series

TKP35 series

TKK series

EasyTrax® series

01 Cable carrier design

Cable carrier

Cable carrier configuration

Configuration guidelines

Materials information

MONO series

QuickTrax® series

UNIFLEX Advanced series

TKP35 series

TKK series

EasyTrax® series

1.1 Solid plastic, hybrid and steel cable carriers

Our product portfolio offers one of the largest modular systems for cable carrier systems within the industry with regard to material and type variants. Depending on the series and cable carrier type, the cable carriers have different designs.

Solid plastic cable carriers

TSUBAKI KABELSCHLEPP offers a great variety of different solid plastic cable carriers with predefined widths. All cable carriers combine robustness and reliability with an attractive price-performance ratio. Fast and easy installation of cables and hoses is another advantage of these cable carriers.



Hybrid cable carriers

Hybrid cable carriers from KABELSCHLEPP® offer a high level of variability for cable carrier widths and separation options within the cable carrier. This allows reliable and efficient partitioning even for complex cable configurations. Hoses and cables with larger diameters can also be accommodated and guided.

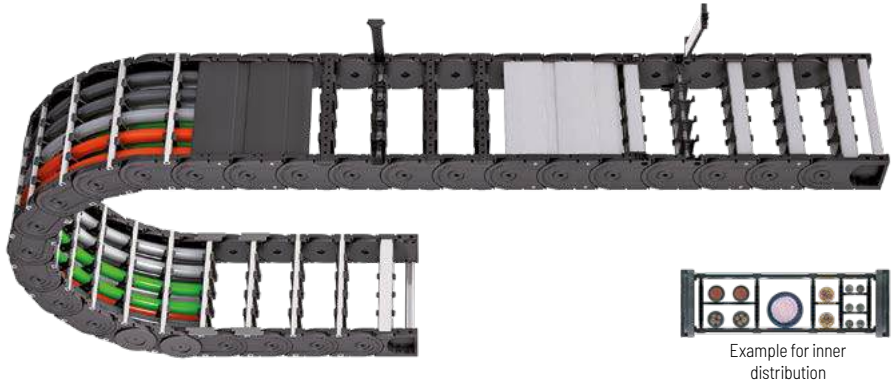

Steel cable carriers

Special applications require the use of special cable carriers. Our steel and stainless steel cable carriers are ideal for extreme heat or other extremely rough ambient conditions, such as in mining, in the steel industry or in the oil industry. Standardized separating options offer best possible protection for cables and hoses even under strong mechanical strain.



Cable carriers consisting of side bands

Band carriers consist of two parallel side bands which are connected with different stay and cover variants. These cable carrier types made of plastic, aluminum or steel offer more variability compared to one-part versions, even for large widths – depending on the stay variant even in a 1 mm grid and more separation options within the cable space.

This allows reliable and efficient partitioning even for complex cable configurations, including with individual hole stays. Hoses and cables with large diameters can also be accommodated and guided without problems. Closed systems provide even better protection.

One-part cable carriers

On one-part cable-carriers, the body section consists of a single component. Crossbars, lamella or covers are mounted on the cable carrier body separately or manufactured directly together with the chain link.

Our basic range comprises a variety of different product types with predefined cable carrier widths. All cable carriers combine robustness and reliability with an attractive price-performance ratio. Fast and easy installation of cables and hoses is another advantage of these cable carriers. Covered and completely enclosed product types ensure optimum protection of the cables and hoses against chips and other coarse contamination.

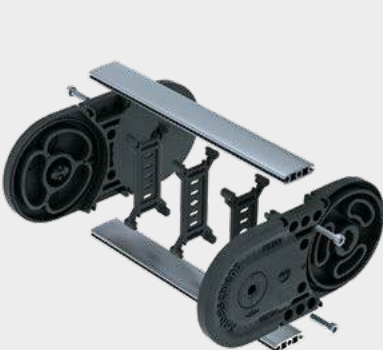

Subject to change without notice.

Cable carrier
Cable carrier configuration
Configuration guidelines
Materials information
MONO series
QuickTrax® series
UNIFLEX Advanced series
TKP35 series
TKK series
EasyTrax® series

BASIC-LINE**Solid plastic cable carriers with fixed widths**

- » Cost-effective solutions for standard applications
- » Types and designs with fixed or opening crossbars
- » Numerous types and designs available from stock immediately
- » Fast cable laying
- » Ideal for short travel lengths and high travel speeds
- » Types for long travel lengths available

BASIC-LINE^{PLUS}**Solid plastic cable carriers with fixed widths**

- » Cost-effective solutions for standard applications
- » Easy pulling/pressing of the cables into the cable carrier
- » Very fast cable laying
- » Numerous types and designs available from stock immediately
- » Ideal for short travel lengths and high travel speeds

3D-LINE**Cable carriers for 3D applications**

- » Ideal for maximum freedom of movement in 3D applications
- » Three-dimensional swivel and rotation movements, for example on robots for use from robot base to robot wrist
- » Extend the service life of cables in 3D applications through defined minimum bending radius and separation and guiding of the cables
- » For extremely high tensile forces and accelerations

STEEL-LINE**Steel cable carriers for extreme applications**

- » Robust design for high mechanical loads
- » High additional loads and extensive unsupported lengths possible
- » Ideal for extreme and rough environmental conditions
- » Heat-resistant

VARIO-LINE

Cable carriers with variable chain widths



- » Aluminum stays available in 1 mm width sections
- » Plastic stays available in 4, 8 or 16 mm width sections (depending on type)
- » Easy and quick to open inside and outside
- » Light, extremely robust or linkless series
- » Cable carriers for complex applications

TUBES-PLASTIC

Covered solid plastic and hybrid cable carriers



- » Covered cable carriers with plastic or aluminum cover systems
- » Aluminum cover systems in 1 mm width sections
- » To protect cables and hoses against chips or dirt
- » Easy and quick to open inside and outside

TUBES-STEEL

Covered steel cable carriers for extreme applications



- » Robust design for high mechanical loads
- » High additional loads and extensive unsupported lengths possible
- » Ideal for extreme and rough environmental conditions
- » Heat-resistant

ACCESSORIES

for cable carriers



Our extensive range of accessories for a variety of different applications turn cable carriers into complete cable carrier systems. In addition to chutes and channels, support elements and guiding elements, we offer application-specific products such as driver connections or opening tools.

Cable carrier

Cable carrier configuration

Configuration guidelines

Materials information

MONO series

QuickTrax® series

UNIFLEX Advanced series

TKP35 series

TKK series

EasyTrax® series

1.2 Pitch and inner height as characteristic parameters for cable carriers

Pitch and inner height are essential components of application-specific solutions. Depending on the installation space of your application, these have to be configured individually. The chapter "Cable carriers" from page 14 offers an overview of the configuration options, depending on the cable carrier type.

1.3 Explanation of KR and RKR as well as KR/RKR

A cable carrier can be deflected at a defined bending radius (KR). A reverse bending radius (RKR) is the formation of a radius (preferably on the driver of a cable carrier) in the opposite direction to the actual KR of the remaining cable carrier. This variant is used, for example, for reducing the cable carrier overhand in the thrust end position (station length).

This version is used for gliding cable carriers with long travel lengths, among other applications. Depending on the cable carrier type, we offer standardized models with so-called GO modules. The cable carrier can also be deflected in both swivel directions (KR/RKR), e.g. for circular arrangements.

KR (bending radius)

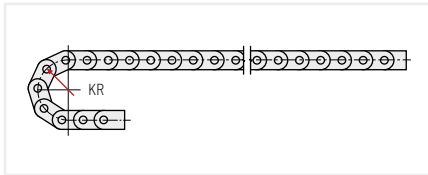

RKR (reverse bending radius)

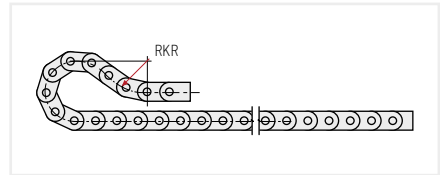

GO module

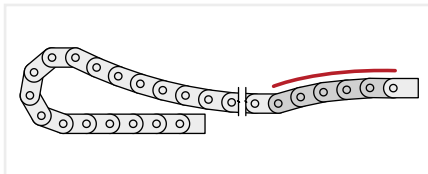

Pull position

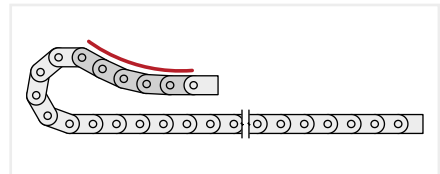

Push position



TSUBAKI KABELSCHLEPP technical support

If you have any questions about the configuration of cable carriers or technical details, please contact our technical support service at technik@kabelschlepp.de. We will be happy to help you.

02 Stay variants

2.1 Overview

The stay variants available for each cable carrier series can be found in the overview of the associated catalog chapter or in the "Cable carriers" chapter from page 14.



Aluminum stay RS | Hybrid cable carriers

Narrow frame stay "The standard"

- » Extremely quick to open and close
- » Aluminum profile bars for light to medium loads. Assembly without screws.
- » Available customized in **1 mm grid**.
- » **Inside/outside:** release by turning by 90°.



Aluminum stay RS 1 | Steel cable carriers

Narrow frame stay "The standard"

- » Extremely quick to open and close
- » Aluminum profile bars for light to medium loads. Assembly with screws.
- » Available customized in **1 mm grid**.
- » **Outside:** release by turning by 90°.
- » **Inside:** threaded joint easy to release.



Aluminum stay RS 2 | Steel cable carriers

Frame stay narrow, bolted

- » Quick to open and close.
- » Aluminum profile bars for light to medium loads. Assembly with screws.
- » Available customized in **1 mm grid**.
- » **Inside/outside:** threaded joint easy to release.



Aluminum stay RV | Hybrid cable carriers

Frame stay, reinforced

- » Aluminum profile bars with plastic adapter for medium to high loads and large cable carrier widths. Assembly without screws.
- » Available customized in **1 mm grid**.
- » **Outside/inside:** release by turning by 90°.



Aluminum stay RV | Steel cable carriers

Frame stay, reinforced

- » Aluminum profile bars with plastic adapter for medium to high loads and large cable carrier widths. Double threaded joint on both sides.
- » Available customized in **1 mm grid**.
- » **Inside/outside:** Threaded joint easy to release.



Aluminum stay RM

Frame stay, solid

- » Aluminum profile bars for heavy loads and maximum cable carrier widths. Double threaded joint on both sides "**Heavy Duty**".
- » Available customized in **1 mm grid**.
- » **Inside/outside:** threaded joint easy to release.



Aluminum stay LG

Hole stay, split version

- » Optimum cable routing in the neutral bending line. Split version for easy cable routing. Stays also available unsplit (aluminum stay LU).
- » Available customized in **1 mm grid**.
- » **Inside/outside:** threaded joint easy to release.



Aluminum stay RMF

Frame stay, solid with optional fixing bar

- » Aluminum profile bars for heavy loads and large cable carrier widths. Simple threaded joint.
- » Available customized in **1 mm grid**.
- » **Inside/outside:** threaded joint easy to release.



Aluminum stay RMS

Frame stay solid with ball joint

- » Aluminum profile bars with plastic ball joint. Assembly without screws.
- » Opening and detachable on both sides in any position.
- » Available customized in **1 mm grid**.
- » **Inside/outside:** Opening and detachable.



Aluminum stay RMA

Mounting frame stay

- » Aluminum profile bars with plastic mounting frame stays for guiding very large cable diameters.
- » Available customized in **1 mm grid**.
- » **Inside/outside:** threaded joint easy to release.



Aluminum stay RMR

Frame rolling stay

- » Aluminum profile bars with rotating plastic rolling stay for highest requirements with gentle cable guiding. Double threaded joint on both sides.
- » Available customized in **1 mm grid**.
- » **Inside/outside:** threaded joint easy to release.



Steel stay RR

Frame stay, tube version

- » Steel rolling stays with gentle cable support and plastic dividers. With plastic or steel dividers, depending on cable carrier type. Ideal for using media hoses with soft jackets. Simple threaded joint.
- » Available customized in **1 mm grid**.
- » **Inside/outside:** Threaded joint detachable.



Aluminum stay RSH

Frame screw-in stay

- » Aluminum profile bars for light and medium loads. Assembly without screws.
- » Available customized in **1 mm grid**.
- » **Outside/inside:** release by turning.



Aluminum cover RMD | Hybrid cable carriers

Cover with hinge in the outer radius "standard"

- » Aluminum cover system with hinge for light and medium loads. Assembly without screws.
- » Available customized in **1 mm grid**.
- » **Outside:** swivable to both sides.
- » **Inside:** release by turning by 90°.



Aluminum cover RMD | Steel cable carriers

Aluminum cover system

- » Bolted aluminum covers for maximum stability.
- » For applications generating chips or coarse contamination.
- » Available customized in **1 mm grid**.
- » **Inside/outside:** threaded joint easy to release.



Plastic stay RE

Frame screw-in stay

- » Plastic profile bars for light and medium loads. Assembly without screws.
- » Available customized in **4, 8 or 16 mm grid** depending on type.
- » **Outside/inside:** release by turning by 90°.



Plastic stay RE

Frame screw-in stay

- » Plastic profile bars for light and medium loads. Assembly without screws.
- » Available in fixed widths depending on type.
- » **Outside/inside:** release by turning by 90°.



Plastic stay RD

Frame stay with hinge

- » Plastic profile bars with hinge for light and medium loads. Assembly without screws.
- » Available customized in **8 or 16 mm grid** depending on type.
- » **Outside:** swivable to both sides.
- » **Inside:** release by turning by 90°.



Plastic cover RD

Cover with hinge in the outer radius "standard"

- » Plastic cover system with hinge for light and medium loads. Assembly without screws.
- » Available customized in **8 or 16 mm grid** depending on type.
- » **Outside:** swivable to both sides.
- » **Inside:** release by turning by 90°.

2.2 Opening options

The stays in the cable carriers can be opened in different ways, depending on the stay variant. Detailed information can be found in the overview of the stay variants from page 49 and in the respective catalog chapters for the cable carrier types.

Overview of opening principles

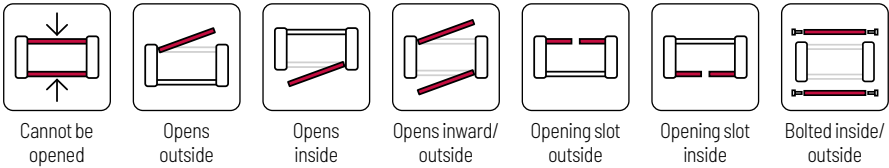

2.3 Explanation of fully stayed and half-stayed

Depending on the version, a different number of stays can be mounted on the number of chain links in our cable carriers. Essentially, there are two versions:

Half-stayed (HS)



Most cable carriers are supplied half-stayed as a standard (stay of every 2nd link). This excludes closed cable carriers where no half-stayed version is available and versions where chain link and stay form a unit.

The half-stayed cable carrier versions still offer a very high level of stability thanks to a sturdy connection between the stays and the link plates. In addition to the cost advantage due to fewer components, this also results in reduced assembly time.

Fully-stayed (VS)



As the dividers are also mounted on every 2nd chain link as a standard, the same structure for the inner distribution as in a fully-stayed cable carrier can be used on a half-stayed version. After examination of the application at hand, we may recommend using fully-stayed cable carriers when installing very thin cables or when using very narrow cable carriers to improve side stability.

Cable carrier

Cable carrier configuration

Configuration guidelines

Materials information

MONO series

QuickTrax® series

UNIFLEX Advanced series

TKP35 series

TKK series

EasyTrax® series

03 Divider systems

3.1 Overview

Divider and height separation serve to separate cables in the cable carrier cross section. These can be arranged evenly next to each other, on top of each other and offset.

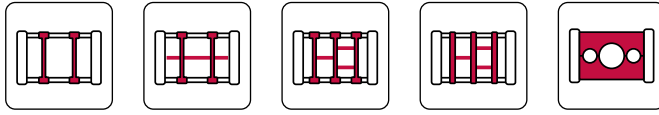

TS0

TS1

TS2

TS3

Hole stay

As a standard, the divider system is mounted at every 2nd chain link.

3.2 Explanation of the systems

Divider system TS0

without height separation

Dividers for vertical separation [1] can be installed between all types of stay variants. They efficiently separate the cables to prevent friction between different jacket materials. This provides best possible protection for cables and insulation.

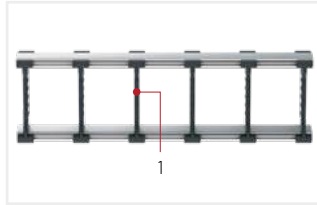

Divider system TS1

with continuous height separation

In addition to the vertical separation with dividers [1], the inner height is divided into several levels with a horizontal height separation [2] across the entire inner width, systematically layer by layer. This creates order and a clear structure for multiple cables with a similar cross section.

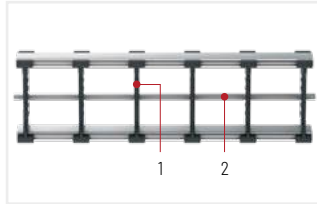

Divider system TS2

with partial height separation

This divider system allows all combinations of vertical separation with dividers [1] and partial horizontal height separation [2] made of aluminum in a 1 mm grid.

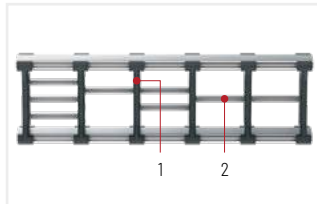

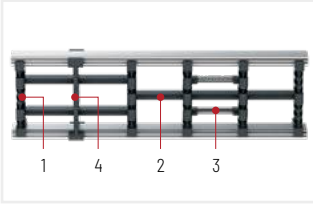

Divider system TS3

with height separation made of plastic partitions

This divider system allows all combinations of vertical separation with dividers [1] and partial horizontal partitions made of plastic [2] or optionally of aluminum [3] in a 3 mm grid. These can also be retrofitted or changed by rearranging.

The twin divider [4] additionally provides the option of subsequent vertical separation.

Modern TS3 divider systems reduce the packaging space required for this to a minimum, providing more cable space.

Width comparison

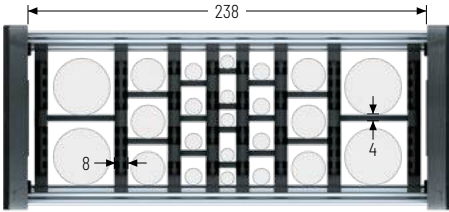

Previous divider system TS3 with stay variant RSH/RE

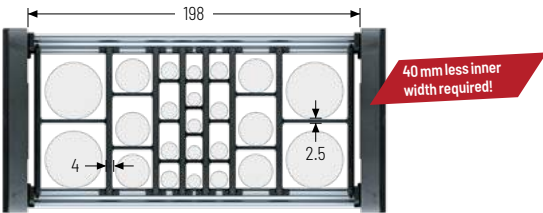

Significant space saving with same filling capacity through the new divider system TS3 with stay variant RSH/RE

Width optimization through adapted dividers

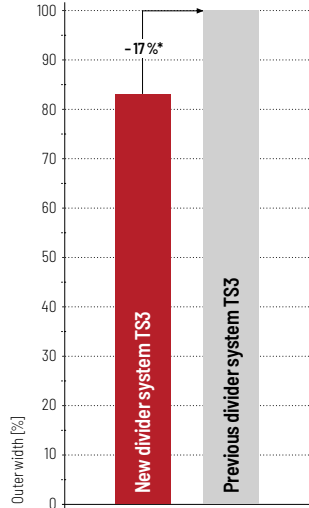

* For inner width $B_3 = 238$ mm with stay variant RE

Cable routing with hole stays

Stay variant LG

Individually manufactured hole stays allow the inner distribution to be ideally adapted to your cables. The hole stays can be guided in the neutral bending line. Cable carriers with aluminum stays can therefore be ordered customized to the millimeter.

The hole stay system is also very easy to assemble because the cable openings are freely accessible by removing the top part.

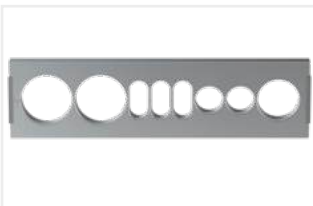

Cable carrier
Cable carrier configuration
Configuration guidelines
Materials information
MONO series
QuickTrax® series
UNIFLEX Advanced series
TKP35 series
TKK series
EasyTrax® series

04 Connection variants

4.1 Explanation of UMB, plastic end connectors and steel end connectors

Depending on the cable carrier type and specific application, we offer different end connectors for fastening your cable carrier to your plant sections.

- » **Driver connection:** Fastening to moving machine or plant parts.
- » **Fixed point connection:** Fastening to static machine or plant parts or the floor.



Universal end connectors (UMB), plastic

The universal end connectors (UMB) can be connected from the top, from below at the face side or – depending on the type – at the side. An accommodation for strain relief with C-rails and LineFix clamps or strain relief combs is integrated. Universal end connectors are made of solid plastic without metal bushes.



One-part end connectors, plastic

One-part end connectors made of solid plastic can be arranged on the cable carrier in different variants depending on the customer fastening. They are optionally available with integrated strain relief.



Multi-part end connectors, plastic/steel

Link section made of solid plastic, steel end connector. The multi-part end connectors can be connected from the top, from underneath or at the face side, depending on the type. Depending on the cable carrier type, strain reliefs with separate C-rail or strain relief comb can be integrated.



Multi-part end connectors, steel

End connectors made of steel. The multi-part end connectors can be connected from the top or from underneath, depending on the type. Depending on the cable carrier type, strain reliefs with separate C-rail can be integrated.

4.2 Connection variants

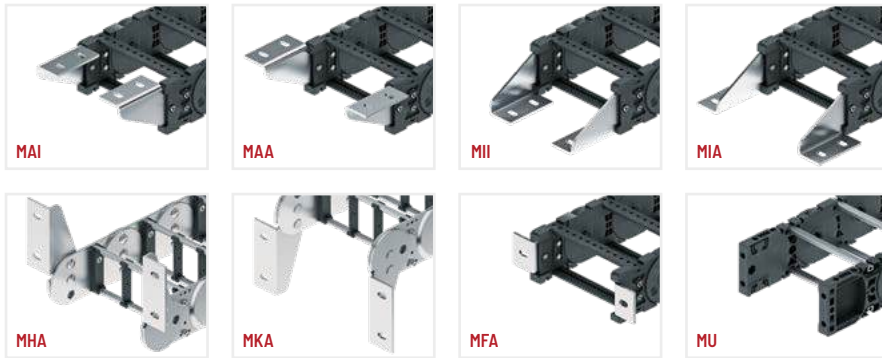
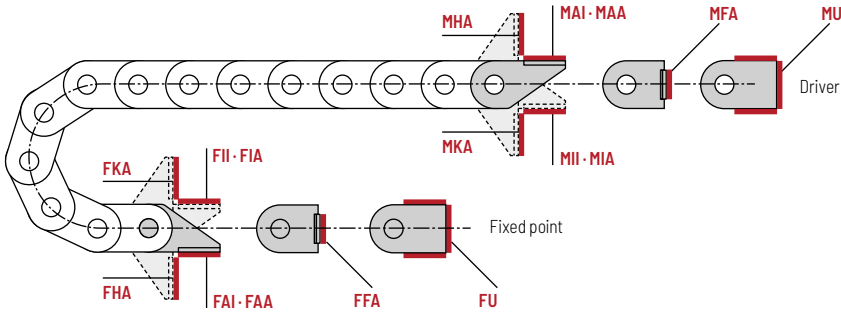

Connection point

- F - fixed point
- M - driver

Connection type

- A - threaded joint outside (standard)
- I - threaded joint inside
- H - threaded joint, rotated 90° to the outside
- K - threaded joint, rotated 90° to the inside
- F - flange connection

Connection surface

- I - connection surface inside
- A - connection surface outside

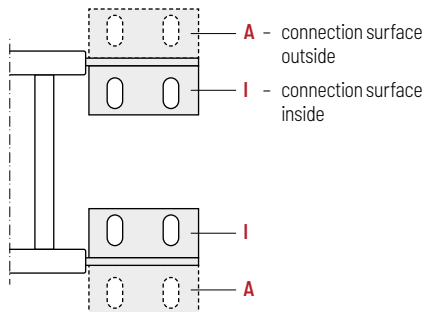
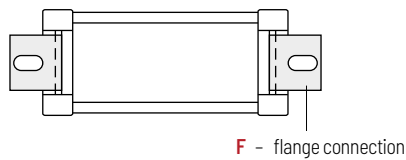

As a standard, the end connectors are installed with the threaded joint (connection type) to the outside and the connection surface to the inside (FAI/MAI).

Cable carrier
Cable carrier configuration
Configuration guidelines
Materials information
MONO series
QuickTrax® series
UNIFLEX Advanced series
TKP35 series
TKK series
EasyTrax® series

05 Strain relief elements

Cable carrier

Cable carrier configuration

Configuration guidelines

Materials information

MONO series

QuickTrax® series

UNIFLEX Advanced series

TKP35 series

TKK series

EasyTrax® series

5.1 Overview and explanation of strain relief options

The strain relief for the cables depends on cable type, length of the cable carrier and installation position. Depending on the cable carrier type and specific application, we offer different strain relief options.



LineFix® clamps

These clamps can be positioned next to each other with a C-rail. The C-rail is integrated into the end connector or has to be fastened separately in front of it.

Detailed information can be found in chapter Accessories from page 906..



Strain relief combs

Strain relief combs can be used to connect the cables to the existing teeth with cable ties. The strain relief combs are integrated into the end connector or have to be fastened separately in front of it.

Detailed information can be found in chapter Accessories from page 910.



SZL strain reliefs

The SZL strain reliefs hold the cables with half shells and fix them in position with detachable clamps. The C-rail is integrated into the end connector or has to be fastened separately in front of it.

Detailed information can be found in chapter Accessories from page 912.



Block clamps

Block clamps are usually used for hoses and hold these with two half shells bolted together, which can be attached to a C-rail. The C-rail is integrated into the end connector or has to be fastened separately in front of it.

Detailed information can be found in chapter Accessories from page 913..

More on the use of strain reliefs and assembly information can be found in the configuration guidelines from page 62.

06 Gliding elements

6.1 Use of glide shoes

We offer different solutions for a substantially extended service life of the cable carrier in case of long travel lengths in gliding operation.



Replaceable glide shoes made of plastic

The replaceable glide shoes are a very cost-efficient solution as only the glide shoes and not the complete cable carrier have to be replaced when worn. An abrasion resistant material is used for travel speeds > 2.5 m/s and high additional loads.

OFFROAD glide shoes with 80 % greater wearing volume is also available for the types M0650-M1300. We recommend their use for extreme ambient conditions (for especially abrasive substances such as sand, dust, corundum).



Slide discs

If the cable carrier is positioned so it is rotated by 90° (gliding on the outside of the side band), slide discs snapped onto the side optimize the friction and wear situation.



Molded slide runners

These ensure a long service life of the cable carrier for long travel lengths and high additional loads.

Cable carrier

Cable carrier configuration

Configuration guidelines

Materials information

MOND series

QuickTrax® series

UNIFLEX Advanced series

TKP35 series

TKK series

EasyTrax® series

07 Multi-band cable carriers

Cable carrier

Cable carrier configuration

Configuration guidelines

Materials information

MONO series

QuickTrax® series

UNIFLEX Advanced series

TKP35 series

TKK series

EasyTrax® series

7.1 Area of application for multi-band cable carriers

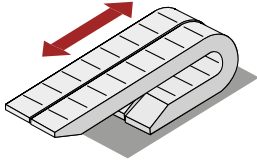

High additional loads and longest possible service lives are a challenging combination for the design engineering of cable carriers. Many applications are subject to extreme ambient conditions, requiring special solutions. If the max. permitted width or load for the cable carrier are exceeded, multi-band cable carriers are used where additional side bands are installed between the two outer side bands.

Cable carriers in multi-band design made from plastic or steel can manage significantly higher loads compared to the conventional version. The use of aluminum frame stays allows implementation of precision-fit cable carrier widths with high stability. The most common structures are three-band and four-band cable carriers.



The cable-carriers with double-band design are designed for a particularly long service life, such as the types LS/LSX1050 and MC1300. In this design, an additional side band is bolted to the existing one.

This results in maximum stability, allowing the double-band cable carrier to double its load capacity.





Configuration guidelines

Selecting a suitable cable carrier

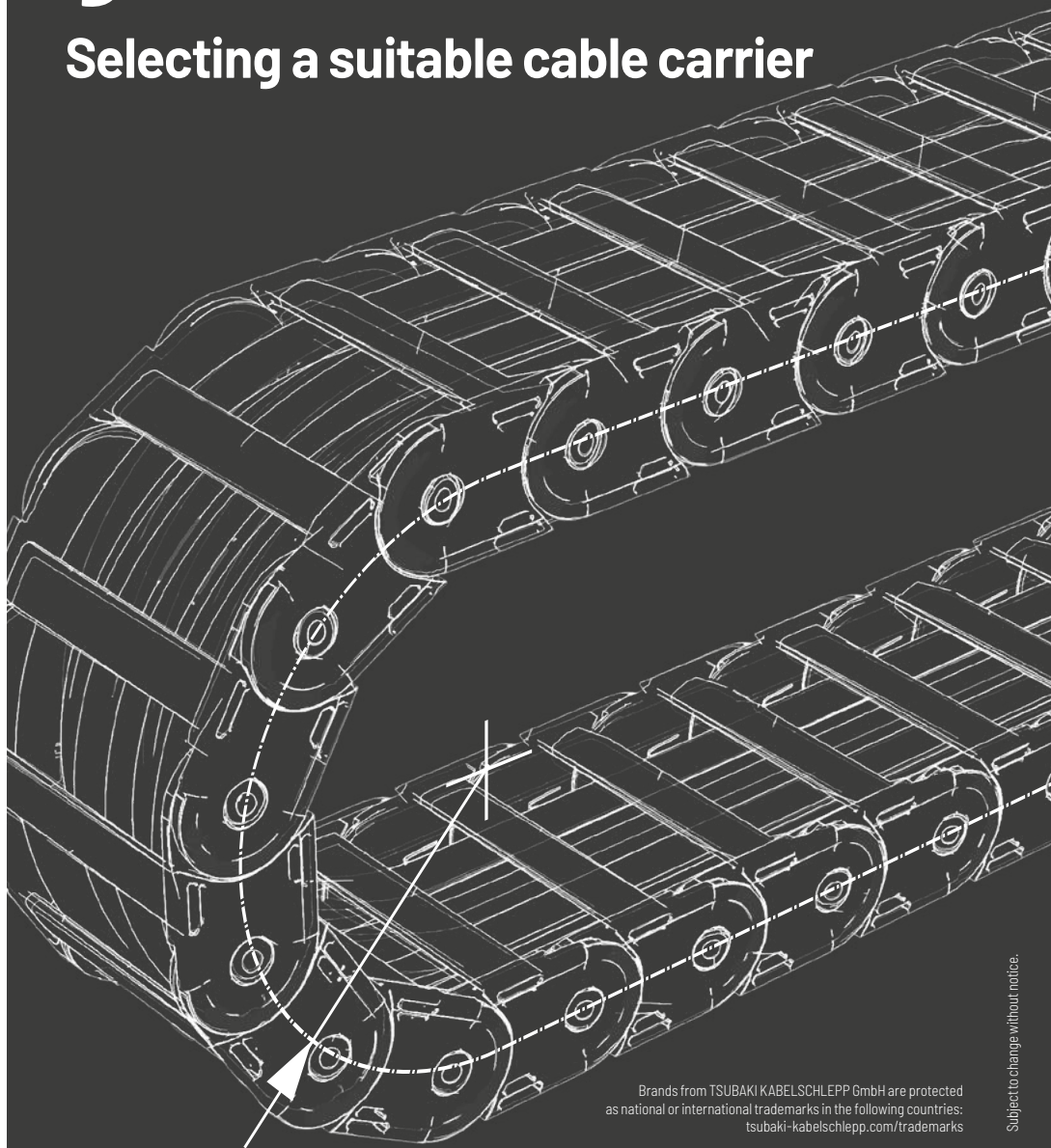

Brands from TSUBAKI KABELSCHLEPP GmbH are protected as national or international trademarks in the following countries: tsubaki-kabelschlepp.com/trademarks

Subject to change without notice.

Content

01

Selecting a suitable cable carrier page 64

- » Required basic data for determination
- » Selecting the suitable version
- » Defining the cable carrier size
- » Determining the cable carrier length (L_k)
- » Connection height, pretension & installation height
- » Consideration of stability
- » Consideration of relative displacement

02

Placement guidelines for cables and hoses page 72

- » General guidelines
- » Placement of pressure hoses
- » Strain relief
- » Strain relief for gliding cable carriers

03

Installation variants page 76

- » Examples for your application

Cable carrier

Cable carrier
configurationConfiguration
guidelinesMaterials
informationMONO
seriesQuickTrax®
seriesUNIFLEX
Advanced
seriesTKP35
seriesTKK
seriesEasyTrax®
series

01 Selecting a suitable cable carrier

1.1 Required basic data for determination

The cable carrier is selected based on different factors which have to be considered in combination. The following parameters should therefore be already available when starting to select a cable carrier:

- » **Installation of cables and hoses**
(Number and diameters of the installed cables and hoses as well as the cable weight including media (kg/m), required minimum bending radius)
- » **Dynamic parameters**
(Travel speed, acceleration/deceleration, desired motion cycles)
- » **Motion sequence**
(For which type of motion is the cable carrier used?)
- » **Installation situation**
(How much space is available? Installation width? Installation height?)
- » **Operating temperature**
- » **Contamination and degree of contamination**
(Which type of contamination? Which amount?)
- » **Application-specific ambient influences**
(e.g. chips, oil, moisture, chemicals)

1.2 Selecting a suitable version

TSUBAKI KABELSCHLEPP offers a variety of cable carriers for all areas of application. The suitable product can be roughly determined with the available basic data.

Selecting the suitable material: side bands made of steel or plastic?

In addition to the environmental conditions, the selection of the suitable material is determined by the dynamic parameters and the load on the cable carrier. Plastic cable carriers have become established in many areas of application over the years. The application should always be examined in detail beforehand, though. The following table shows the operating parameters as a configuration tool for the suitable cable carrier material:

Operating conditions	Plastic	Steel	Operating conditions	Plastic	Steel
Travel speed > 2 m/s	+	-*	Vacuum	-	+***
Travel cycle > 1 million	+	-*	Extremely rough operating conditions (e.g. heavy industry, mining, drilling)	•	+
Continuous temperature			Very high mechanical load	•	+
< -40° C	-**	+			
-40° C to +100° C	+	+			
> +100° C	-**	+			
Acidic environment	-	+***			
Radioactive radiation	-	+***			

+ very suitable * possible as custom version
 • suitable ** special material available
 - not suitable *** stainless steel version available

Our technical support can provide help for critical applications: technik@kabelschlepp.de

Selecting the cable protection: open or closed cable carrier?

The selection of the suitable cable carriers can be further limited with the question whether the guided cables require additional protection (e.g. against foreign bodies) and whether a cable carrier with a cover system is practical.

The following table is a simple guideline; the exact choice should be determined after detailed examination of the specific application. In many cases, closed cable carriers are also used to hide the cables for visual reasons.

For very large accumulations of fine contamination (e.g. dust or sand), especially in combination with moisture, we advise against using the cover systems. This affects the function of the overlapping covers substantially.

Cover systems are available for steel and plastic cable carriers.

Operating conditions	Open cable carriers	Covered cable carriers
Coarse contamination (e.g. chips, metal parts, glass splinters)	•	+
Hot chips/metal spatter	-	+*
Visual protection (hiding the cables)	-	+
Very high incidence of fine contamination (e.g. sand, dust, scale)	•/+	-
Very fine contamination and moisture (e.g. moist dust)	•/+	-

+ very suitable
 • suitable
 - not suitable

* Also possible as steel band cover, see page 916
 Special materials for covers on plastic cable carriers possible



Example:
Cover system with chips



Negative example:
Cover system with high dust accumulation

According to the specification plastic/steel and open/closed, you can select the suitable cable carriers according to the following diagram in the respective catalog chapter:

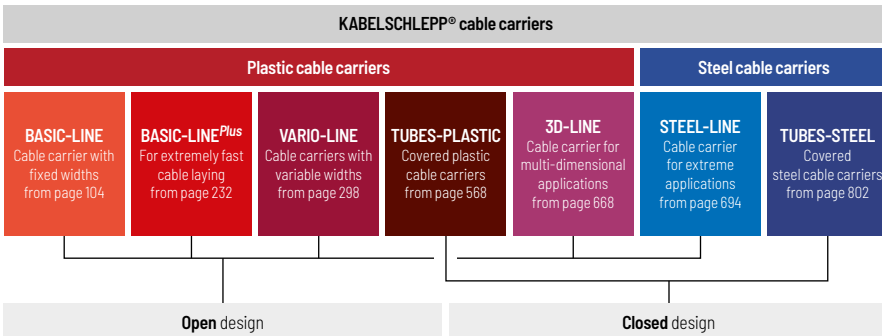

Configuration guidelines	Cable carrier configuration
Materials information	MONO series
QuickTrax® series	UNIFLEX Advanced series
TKP35 series	TKK series
EasyTrax® series	

1.3 Defining the cable carrier size

The number and diameter of the cables to be installed play a major role here. Very often, the dimensions of the installation space for using a cable carrier are very limited. Both these prerequisites therefore have to be balanced.

The basic data of the cables to be installed are required for the further configuration of the cable carrier:

- » Type (cable or hose)
- » Cable weight incl. media (q_c)
- » Outer diameter (d)
- » Minimum bending radius (KR_{min})

Please select a cable carrier with a sufficient inner height (see page 40). Adequate space on the side for placing the cables should also be planned for the initial configuration. They have to be arranged freely in the cross section of the cable carrier. The following minimum values for the required space apply:

Cables: $1.1 \times d$ (for diameter $d < 20$ mm, minimum required space: $d + 2$ mm)

Hoses: $1.2 \times d$ (for diameter $d < 20$ mm, minimum required space: $d + 4$ mm)

More information for installing cables can be found in chapter Placement guidelines on page 72.

Cable carrier

Cable carrier configuration

Configuration guidelines

Materials information

MONO series

QuickTrax® series

UNIFLEX Advanced series

TKP35 series

TKK series

EasyTrax® series

The first draft for a so-called stay pattern can then look as follows, for example:

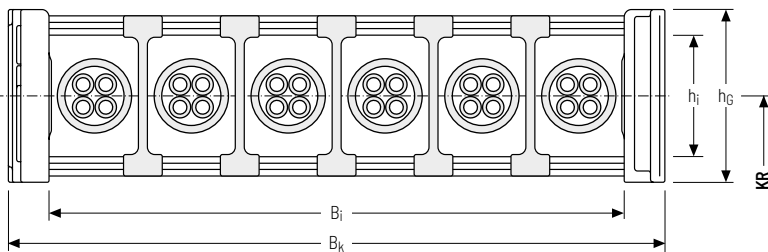

It is possible that the cable carrier becomes too wide with regard to the permitted installation dimension. In this case, a larger cable carrier can be used in combination with one of the divider systems. The placement could then look as follows, for example:

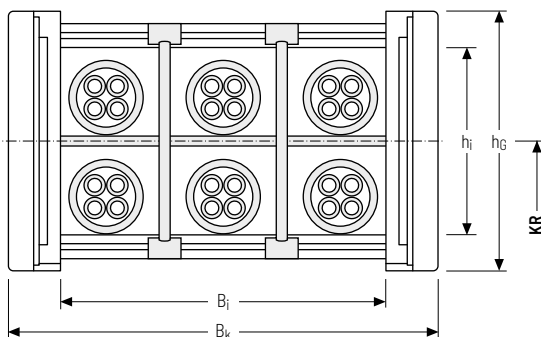

For the installation of cables in the cable carrier, please also take the selected installation variant into account (see page 76) which can have additional implications for loading the cable carrier. The different available stay variants (e.g. hole stay, tube stay) also allow different variations to suit the application.

This initial draft still has to be verified with regard to the further configuration of the cable carrier in the following (e.g. unsupported use).

Determining the bending radius KR

The chapter for the selected cable carrier contains the sizes of the available bending radii. The selection of the bending radii depends on the cables used. The information from the cable manufacturer regarding the dynamically moving minimum bending radius have to be taken into account for this.

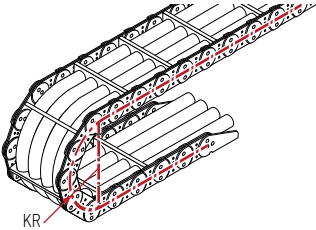

The selected bending radius of the cable carrier has to be equal to or greater than the largest minimum bending radius of the cables to be installed.

We recommend using KABELSCHLEPP® cables which were specially designed for use in cable carriers.

1.4 Determining the cable carrier length L_k for simple linear travel

It is practical to place the fixed point connection at the center of the travel path. This provides the shortest connection between fixed and movable driver point and therefore the most economical cable carrier and cable length. Of course your cable carrier can also be installed with a fixed point outside of the center of the travel path. The calculation follows these examples:

For fixed point at the center of travel path L_s, the following applies for cable carrier length L_k:

Cable carrier length L_k

$$L_k \approx \frac{L_s}{2} + L_B$$

Cable carrier length L_k rounded to pitch t

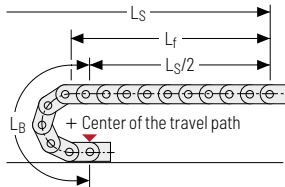

The length of carrier in bend L_B is determined according to the selected cable carrier type:

Type	Length of carrier in bend L _B
Plastic cable carriers	$L_B = KR \times \pi + 2 \times t$
LS/LSX series	$L_B = KR \times \pi + 2 \times t$
S/SX series	$L_B = KR \times \pi + 4 \times t$
QUANTUM® series	$L_B = KR \times \pi + 12 \times t$
TKR series	$L_B = KR \times \pi + 2 \dots 4 \times t$

The calculated values can be found in the tables in the respective individual chapters.

For fixed point outside of the center of travel path L_s, the following applies for cable carrier length L_k:

Cable carrier length L_k

$$L_k \approx \frac{L_s}{2} + L_B + |L_v|$$

Cable carrier length L_k rounded to pitch t

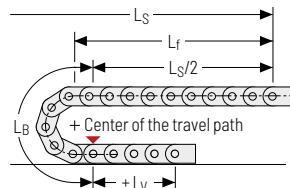
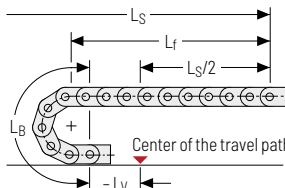

Cable carrier
Cable carrier configuration
Configuration guidelines
Materials information
MONO series
QuickTrax® series
UNIFLEX Advanced series
TKP35 series
TKK series
EasyTrax® series

Verification of the load values for unsupported arrangement

The term "unsupported arrangement" describes the condition when the upper run moves parallel to the lower run across the entire horizontal travel length.

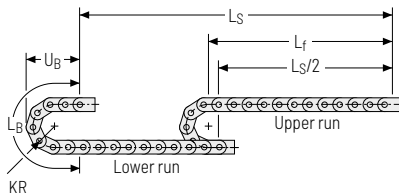

The unsupported arrangement is the most common use of cable carriers. The unsupported length L_f resulting from the travel length, and its load on the cable carrier is determined with the cable weight to be guided q_z from the load diagram.

The load diagram therefore marks the area of the unsupported length L_f in which the cable carrier has no appreciable sagging or, in reverse conclusion, the maximum cable weight at which the cable carrier does not yet sag. If the travel length or the cable weight increases above the value stated in the diagram, the cable carrier starts to sag.

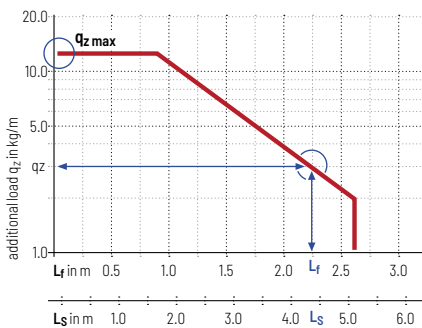

The specific load diagrams can be found in the individual chapters. Please note that the diagrams were determined with a specific intrinsic cable carrier weight. This means that the usable additional load can be reduced for large cable carrier widths or for cover systems.

Furthermore, the upper value q_z in the diagram indicates the maximum additional load of the cable carrier.

This value must not be exceeded.

The figure on the left shows an example for a load diagram with the most important parameters for determining the respective cable carrier load.

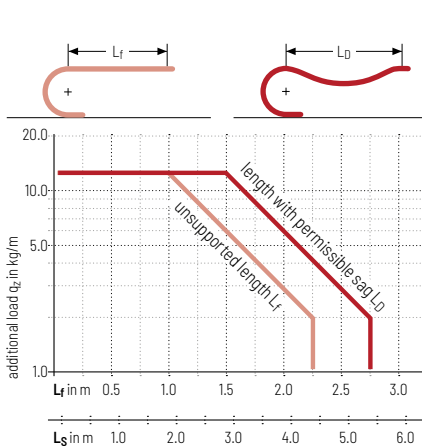

According to definition, the unsupported length L_f is the length at which the upper run of the cable carrier has no appreciable sag.

For steel cable carriers, sagging is not permitted as a rule. The higher flexibility of the plastic cable carriers allow a slight increase of the additional load or of the unsupported length. As a rule, we advise against this *unsupported arrangement with permitted sag* L_0 for reasons of dynamics and appearance.

Increased wear of the links also has to be expected. It cannot be ruled out, however, that in individual cases a solution may have to be implemented in this way at low travel speeds. In this case, please request the corresponding values from us.

We will be happy to advise you.

Exceeded the load diagram?

There are several options if the unsupported length of the cable carrier is exceeded:

- » Selecting a more sturdy cable carrier with a longer unsupported length and higher additional load
- » Using a multi-band carrier for increasing the additional load
- » Supporting the upper run after the fixed point: depending on the dynamic parameters, this arrangement can practically double the travel length. We are happy to help with configuring a suitable support structure.
- » For very long travel lengths, the cable carrier has to be configured as gliding or rolling.

More information on these installation variants can be found from page 76.

The overall length of the cable carrier

The cable carrier length L_K does not include the length l_1 of the end connectors. To be able to determine the correct required cable and hose length, the value L_{EF} is required. This is calculated as follows:

Overall length cable carrier L_{EF}

$$L_{EF} = L_K + l_1 \text{ Driver connection} + l_1 \text{ Fixed point connector}$$

1.5 Connection height, pretension & installation height

Kabelschlepp cable carriers are manufactured with pretension as a standard in order to implement the most extensive unsupported length possible. This produces an elevation of the upper run in the area of the unsupported length and is already considered in the load diagram.

The pretension increases the installation height of the cable carrier to the total value H_z . The connection height H and the installation height H_z are determined for each cable carrier type according to the following guidelines.

Connection height H and installation height H_z for plastic cable carriers

The values for determining the connection height H can be found in the respective individual chapters. They are generally determined as follows:

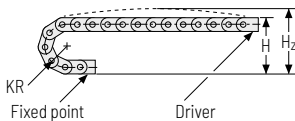

Installation height H_z is also listed in the respective individual chapters as an allowance for the pretension, specifically for each cable carrier.

Type	Connection height H
Plastic cable carriers*	$H = 2 KR + h_G$
M1300 series	$H = 2 KR + 1.5 h_G$
Q040 series	$H_{min} = 2 KR + 45 \text{ mm}$
Q060 series	$H_{min} = 2 KR + 88 \text{ mm}$
Q080 series	$H_{min} = 2 KR + 117 \text{ mm}$
Q100 series	$H_{min} = 2 KR + 143 \text{ mm}$
TKR0150 series	$H = 2 KR + 40 \text{ mm}$
TKR0200 series	$H = 2 KR + 72 \text{ mm}$
TKR0370 series	$H = 2 KR + 70 \text{ mm}$
TKR0260 series	$H = 2 KR + 88 \text{ mm}$
TKR0280 series	$H = 2 KR + 102 \text{ mm}$

* not for M1300

Installation height H_z for steel cable carriers

Due to the higher stability of steel cable carriers, the pretension z can already be taken into account on unsupported arrangements by slightly increasing the connection height H . This is based on the following calculation:

Connection height H for systems without support (unsupported)

$$H = 2 KR + 1.5 h_G$$

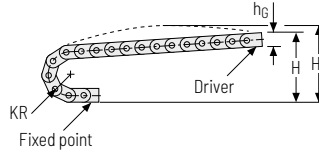

If the unsupported length is increased with support rollers or a continuous support frame, the upper run has to be placed parallel to the support plane.

Connection height H for systems with support

$$H = 2 KR + h_G$$

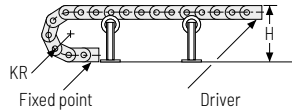

To be sure, another verification of the installation height H_z should be carried out for steel cable carriers depending on the pretension and cable carrier length. The following rule of thumb applies:

Installation height H_z

For example, the installation height H_z for a cable carrier length of $L_k = 5000$ mm increases by 50 mm. Depending on the installation variant, it is still necessary to operate the cable carrier without or with reduced pretension. This is possible on almost all types.

$$H_z = H + z$$

Pretension

$$z \approx 10 \text{ mm/m cable carrier length}$$

1.6 Consideration of stability

In the tension end position, the stability of the cable carrier must be considered. For extensive unsupported lengths, the remaining small support area at the fixed point can reduce the stability for very narrow cable carriers. Accordingly, the ratio between bending radius KR and outer cable carrier width B_k should always be taken into account for dimensioning of the cable carrier.

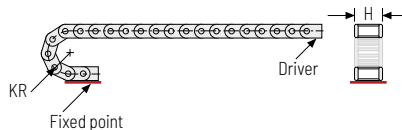

— Support area

If the outer cable carrier width on an extensive unsupported length is significantly smaller than the required bending radius, the option of a lateral support should be considered if stability seems at risk. In this case, please contact our technical support.

1.7 Consideration of relative displacement

An arrangement where the cables are placed next to each other and separately should be preferred. This arrangement is recommended to keep the relative displacement of the cables as low as possible.

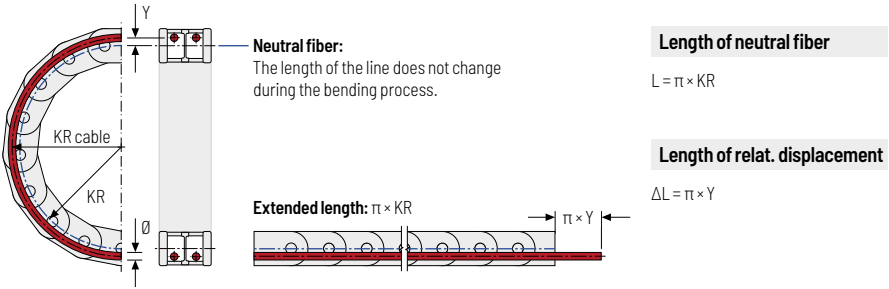

Due to the off-center placement, the cables move in the cable carrier by the value of the relative displacement. This can cause increased cable wear on the stays.



Cable carrier

Cable carrier configuration

Configuration guidelines

Materials information

MONO series

QuickTrax® series

UNIFLEX Advanced series

TKP35 series

TKK series

EasyTrax® series

02 Placement guidelines for cables and hoses

Cable carriers are designed to protect moving energy lines and data lines which can be guided together in a variety of combinations. The following chapters list the guidelines which ensure configuration of the cable carrier system for maximum service life.

2.1 General guidelines

A "direction of view" is defined to allow a clear definition of the position of the cables in the cable carrier. For Kabelschlepp cable carriers, the view is always into the driver.

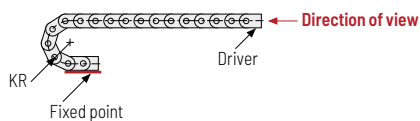

 Only cables which are suitable for use in cable carriers should be used, e.g. TRAXLINE® cables.

Cables and hoses have to be able to move freely in the cable carrier. They must not be attached or tied together.

The following guide values apply for dimensioning the required clearance:

- » **For round cables:**
10 % of the diameter*
- » **For flat cables:**
10 % of the cable width/thickness each
- » **For hoses:**
20 % of the diameter for pressure hoses**
10 % - 20 % for unpressured/low-pressure hoses*

* For diameter $d < 20$ mm, min. space requirement: $d + 2$ mm

** For diameter $d < 20$ mm, min. space requirement: $d + 4$ mm

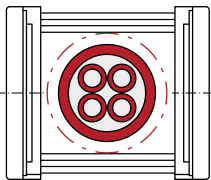

Weight distribution for installation

For the installation of cables and hoses, please ensure that the cable weight is symmetrically distributed across the width of the cable carrier. Even loading can help the cable carrier to achieve its maximum service life.

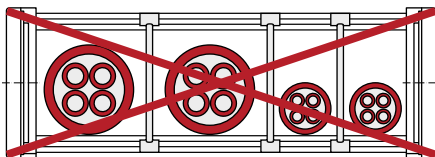

Poor weight distribution

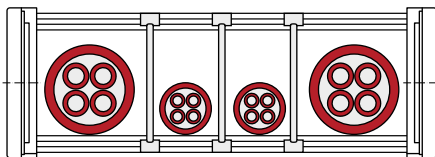

Good weight distribution

No cable loops

When cutting the cables for installation in the cable carrier, remove the cable from the coil tangentially and not in loops.



Do not twist cables

When cutting the cables for installation in the cable carrier, unwind the cable from the drum without twisting it.

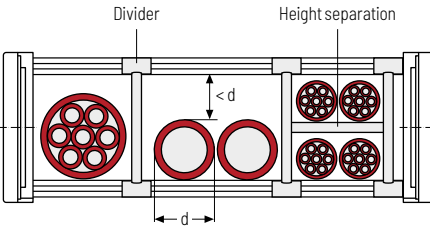

Separating multiple cables

Adjacent cables with strongly differing diameters should be separated by dividers. Directly adjacent placement of cables with strongly differing diameters has to be avoided. If this is unavoidable, ensure that the remaining clearance height is smaller than the smallest cable diameter. This is the only way to prevent the cables from becoming tangled.

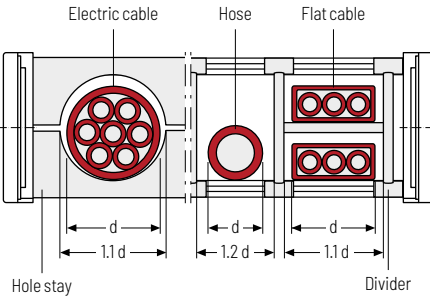

Multiple layers

When placing cables in multiple layers, we recommend installing a height separation between the individual layers for electric cables.

Individually manufactured hole stays or partitions through dividers prevent adjacent cables from rubbing against each other. In many cases, it is beneficial to place each cable in a separate chamber.

A height separation always has to be installed between multiple layers of flat cables.

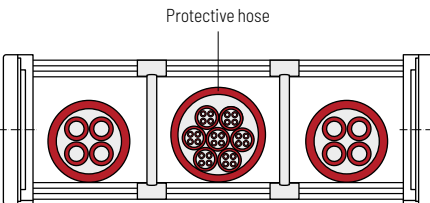

Collating in protective hoses

Thin hi-flex cables with low bending strength have to be loosely bundled and sorted in a protective hose. The cross section of the protective hose has to be significantly larger than the sum of the individual cable cross sections.

As a guideline for determining the cross section: each cable takes up approx. 10 % of its diameter as a clearance all around.

Cable carrier
Cable carrier configuration
Configuration guidelines
Materials information
MONO series
QuickTrax® series
UNIFLEX Advanced series
TKP35 series
TKK series
EasyTrax® series

Cable carrier

It always has to be ensured that the cables can run through the bending radius KR without any tensions or force.

They have to move freely lengthwise and must not exert any towing forces on the cable carrier in the bend.

For multiple layer, the cables have to be placed in such a way that they also have enough clearance between them in the cable carrier bend.

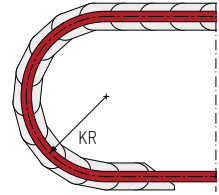

Cable carrier configuration

Configuration guidelines

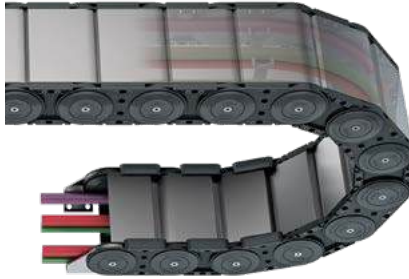

Materials information

Installing cables and hoses in closed cable carriers

For large numbers of electric cables in covered cable carriers or in energy conduits, the current carrying capacity of the cables has to be configured according to the applicable standards, regulations and recommendations so that the maximum permissible temperatures for the corresponding cable materials and the cable carrier material are not exceeded.

For your configuration, please note that this is a closed system.

MONO series

2.2 Placement of pressure hoses

QuickTrax® series

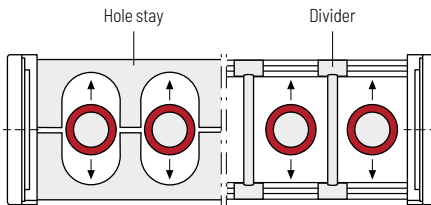

The following applies regardless of the partitioning type of the stay cross section:

Pressure hoses have to be able to move freely because they expand or contract during pressure changes!

Expansion or contraction can be compensated in the bending radius area. The required clearance can be calculated depending on the proportional change (manufacturer's information).

UNIFLEX Advanced series

If technically possible, we recommend placing each pressure hose in a separate chamber.

Pressure hoses are often attached to a tube directly before the driver and fixed point connection. Length differences, which result from the pressure change but also from manufacturing tolerances during installation of the hoses, can result in increased wear in the area of the bending radius.

TKP35 series

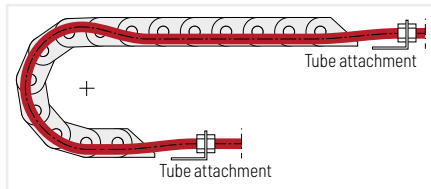

Hose too long

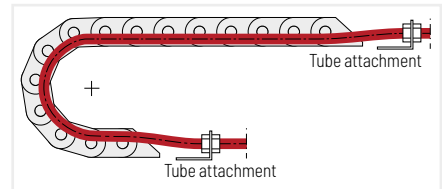

Hose too short

TKK series

EasyTrax® series

For your configuration, please take into account a suitable length compensation for the hoses so they can run through the bending radius without tensions or force. It is often sufficient to provide a loop before the fixed point to compensate for the hose length.

2.3 Strain relief

The strain relief for the cables depends on cable type, length of the cable carrier and installation variant. Generally, it has to be ensured that the retention force is applied on the largest possible area of the outer jacket so that the cables are not crushed while also preventing displacement of the cables.

- » Within the **unsupported area** of the cable carrier, electric cables should preferably be equipped with a strain relief on the driver and on the fixed point. For short travel lengths and smaller cable diameters, we recommend the use of strain relief combs and cable ties for this application. LineFix clamps can also be used for larger cable carriers which use a C-rail.
- » **Longer travel lengths**, which require gliding operation of the cable carrier, should also be equipped with strain relief on the driver and on the fixed point. Secure strain relief, e.g. with LineFix clamps, has to be provided especially at the driver connection where push and pull forces are present. When using the strain relief at the fixed point of a gliding cable carrier, it primarily has to be ensured that the installed height of the strain relief is significantly smaller than the chain link height h_C in order to prevent a collision. For slow travel speeds, it is often sufficient to provide fixation with a strain relief comb and cable ties on the fixed point of gliding cable carriers.
- » For vertically operating cable carriers, the cables also have to be provided with a strain relief on the driver and on the fixed point. For hanging cable carriers with very long travel lengths and high cable weights, it can be practical to install a double strain relief arrangement on both sides.
- » Pressure hoses which will not be bolted on in direct proximity to the driver or fixed point also have to be provided with a strain relief, in the same way as the cables. We recommend the robust block clamps for this case.

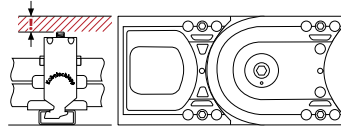

2.3.1 Strain relief for gliding cable carriers

Strain relief on the driver cable carrier end

After moving the cable carrier driver (moving cable carrier end) to the **pushing end position**, the cables are provided with a strain relief at the moving cable carrier end.

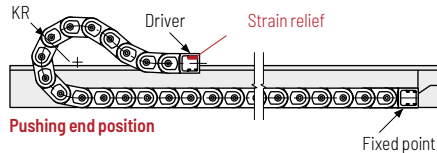

Correct cable length in the cable carrier

After moving the cable carrier driver (moving cable carrier end) to the **pulling end position** of the cable carrier, the cables are checked for tension-free length in the bend and, if necessary, "fed further into the cable carrier".

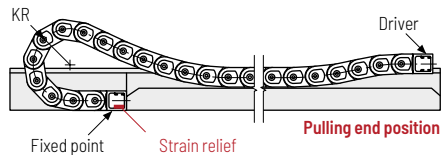

Strain relief on the fixed point cable carrier end

With this tension-free "inserted length", the cables are finally provided with a strain relief at the fixed point cable carrier end.

i Test operation of the cable carrier: After an initial test run, check the tension-free cable routing and, if necessary, adjust the strain relief at the fixed point.



Cable carrier

Cable carrier configuration

Configuration guidelines

Materials information

MONO series

QuickTrax® series

UNIFLEX Advanced series



TKP35 series

TKK series

EasyTrax® series

03 Installation variants

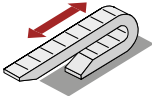
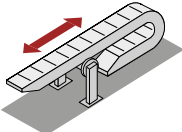
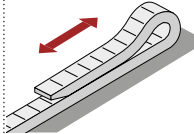
Overview of installation variants

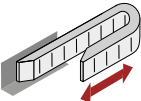
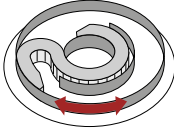
Code	Symbol	Designation	Plastic cable carriers	Plastic tubes	Steel cable carriers	Steel tubes	Page
INV1		Horizontal arrangement, unsupported	•	•	•	•	78
INV2		Horizontal arrangement, with support	◦ / -	◦ / -	•	•	79
INV3		Horizontal arrangement, gliding in guide channel	•	•	•	•	80
INV4		Vertical arrangement, hanging	•	•	•	•	81
INV5		Vertical arrangement, standing	•	•	•	•	82
INV6		Horizontal arrangement, rotated 90° (straight)	•	•	◦	◦	83
INV7		Horizontal arrangement, rotated 90° (circular)	◦	-	◦	-	85

- Standard version
- Customized
- Not possible

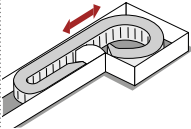
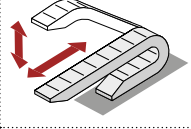
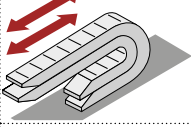
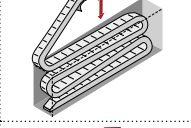
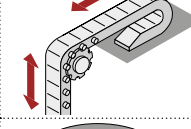
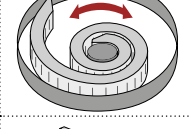
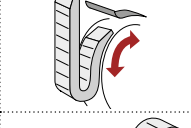
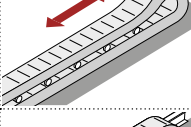
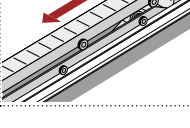
Code	Symbol	Designation	Plastic cable carriers	Plastic tubes	Steel cable carriers	Steel tubes	Page
INV 8		Horizontal arrangement, rotated 90° (rolled)	•	•	◦	◦	87
INV 9		Horizontal-vertical combined arrangement	•	•	•	•	87
INV 10		Unsupported arrangement, nested	•	•	•	•	87
INV 11		Zig-zag arrangement	◦	◦	◦	◦	88
INV 12		Vertical arrangement, hanging with support bolt	-	-	◦	◦/-	88
INV 13		Horizontal arrangement, curled	•	•	◦	◦/-	89
INV 14		Vertically rotating arrangement, hanging	◦	-	◦	-	89
INV 15		Roller chain	•	◦	-	-	89
INV 16		Arrangement with continuous support structure	◦	◦	◦	◦	90

Cable carrier

Cable carrier configuration

Configuration guidelines

Materials information

MONO series

QuickTrax® series

UNIFLEX Advanced series

TKP35 series

TKK series

EasyTrax® series

INV 1

Horizontal arrangement, unsupported



For unsupported arrangement, the driver connection of the cable carrier is attached to the movable system part and moves with it in the horizontal direction.

The upper run of the cable carrier is free, i.e. without support and without sag, parallel above the fully supported lower run.

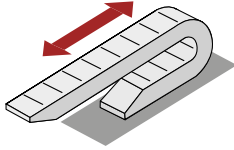

The formulas and configuration information for this installation variant can be found in the chapter "Determining the cable carrier length L_k for simple linear travel" on page 67.

Configuration guidelines

Special case

Horizontal arrangement, unsupported with overhang



The lower run of the cable carrier is not supported across the entire length. We are happy to calculate the required dimensions $A + \ddot{U}$ for your individual application.

Please contact us for individual project planning for your specific application. We will be happy to help.

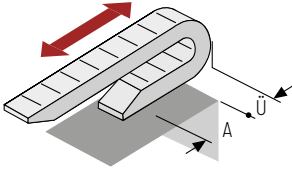

Rule of thumb

$$\ddot{U}_{\max} \leq \frac{L_f}{4}$$



Cable carrier

Cable carrier configuration

Materials information

MONO series

QuickTrax® series

UNIFLEX Advanced series

TKP35 series

TKK series

EasyTrax® series



TSUBAKI KABELSCHLEPP technical support

If you have any questions about cable carriers or technical details please contact our technical support service at technik@kabelschlepp.de. We will be happy to help you.

INV 2

Horizontal arrangement with support

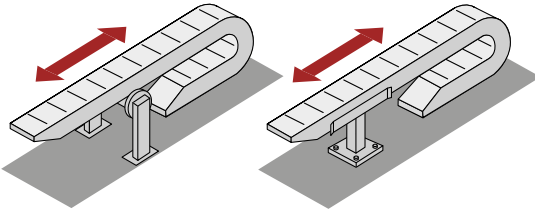

i If the unsupported length of the cable carrier is exceeded, the upper run can be supported.
 We recommend using the next larger type instead of a cable carrier with support(s), if the installation situation allows this.

Support for the upper run is generally possible for almost all cable carriers. The support stand used for plastic cable carriers always has to be equipped with start-up levels. The upper run should be supported as far as possible.

Arrangement of the support

Due to the flexible material and the potential sag, however, there are limitations on the use of supports for plastic cable carriers. The following section therefore examines the arrangement of the support for **steel cable carriers with support rollers**:

Arrangement with one support roller:

for $L_S < 3 L_f$ $a_R = \frac{L_S}{6}$

The distance of the support from the fixed point is approx. 1/6 of the travel length!

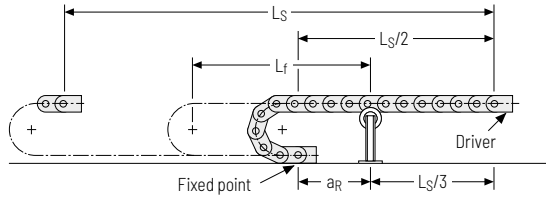

Arrangement with two support rollers:

for $L_S < 4 L_f$ $a_{R1} = 300 \text{ mm}$
 $a_{R2} = \frac{L_S}{4} - 150 \text{ mm}$

First support 300 mm behind the fixed point, second support at the center of the remaining unsupported length!

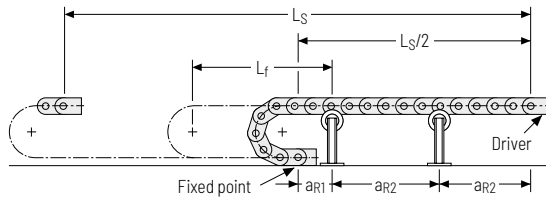

A travel speed of 1 m/s should not be exceeded. When using support rollers, the length L_f should only be 80 % of the value resulting from the load diagram, if possible.

Special version with lateral rollers:

for $L_S < 4 L_f$

To utilize the maximum possible travel length in an unsupported arrangement with stationary support structure.

The lateral track rollers are mounted on the chain links. An even running surface has to be ensured, with a support tray provided if necessary.

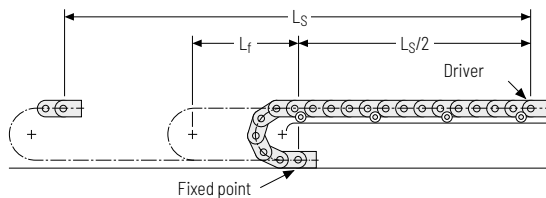

Cable carrier
Cable carrier configuration
Configuration guidelines
Materials information
MONO series
QuickTrax® series
UNIFLEX Advanced series
TKP35 series
TKK series
EasyTrax® series

INV 3

Horizontal arrangement, gliding in the guide channel

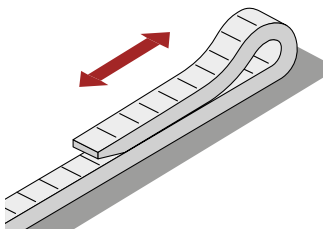

The upper run of the cable carrier **glides** on the lower run or on a gliding surface of the associated guide channel.

Application: For long travel lengths which cannot be implemented as unsupported arrangements.

Condition: The cable carrier must be guided in a channel, though!

Different cable carrier types provide the option of using glide shoes on the inner radius. These are manufactured from a special sliding and wear-resistant plastic. This allows the sliding friction factor to be reduced to a value of $\mu < 0.2$.

For steel cable carriers, the use of these elements is mandatory to prevent gliding of "steel on steel". The travel speed, however, should not exceed 1 m/s for gliding steel cable carriers. For steel cable carriers, the glide shoes are bolted onto the side band.

For plastic cable carriers, the glide shoes are simply clipped on the inner radius and can therefore easily be replaced if necessary.



To reduce wear and increase the service life, we recommend using the abrasion resistant glide shoes for gliding applications. For travel speeds > 2.5 m/s, however, glide shoes should always be used.

Arrangement of the cable carrier

Single-sided arrangement with lowered driver connection and reverse bending radius (standard)

The cable carrier length is always calculated with the same formula as for the unsupported arrangement:

Cable carrier length L_k

$$L_k \approx \frac{L_S}{2} + L_B$$

Cable carrier length L_k rounded to pitch t

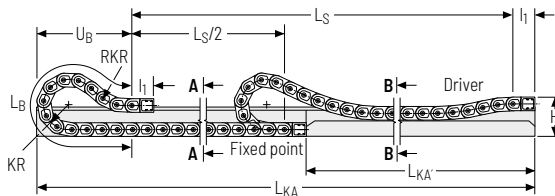

For the standard arrangement of the cable carrier, the driver connection is reduced for load reasons:

Connection height H

$$H = 3h_g$$

The length of carrier in bend L_B is increased by the lower driver connection and the resulting cable carrier extension. To keep this elevation of the length of carrier in bend as small as possible, chain links with reverse bending radius (RKR) are used on the driver connection as a standard. This results in a slight S-shape for the bend in the thrust end position. The respective values for L_B can be found in the respective individual chapters for the cable carriers.

For the configuration of this installation variant we recommend the simple way of determining the cable carrier length using our Configurator at online-engineer.de or requesting support from our support team.

Opposite arrangement with lowered driver connection and reverse bending radius

If the cable carrier is wider than the available space due to a very large number of cables, a second cable carrier can be used, running in the opposite direction. This almost halves the total width because the cables can be distributed among both cable carriers.

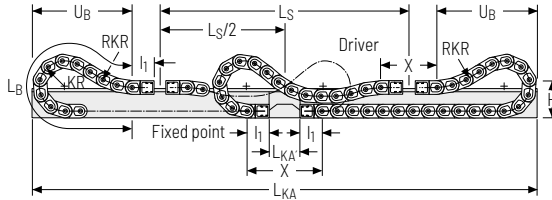

The cable carrier length is then determined in the same way as for single-sided arrangements. For only one moving consuming unit and a joint travel path, both cable carrier lengths have to be the same. As both cable carriers run in a guide channel, it must be ensured that they have the same outer width. More information and the details for dimensioning the guide channel can be found in chapter Support trays and guide channels on page 844.

INV 4 Vertical arrangement, hanging

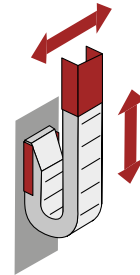
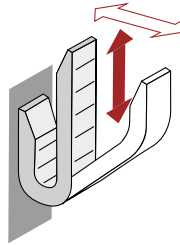
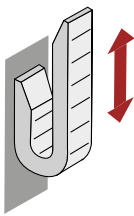

i **Direction of movement:**
only vertical

For a purely vertical movement process, the cable carrier can be mounted without special lateral support.

i **Direction of movement:**
vertical/horizontal combined

For a combined vertical/horizontal movement process, the cable carrier can be mounted without special lateral support.

i **Direction of movement:**
only vertical

If the entire system moves at a right angle to and/or alongside the hanging cable carrier, an additional lateral guide has to be mounted.

Please observe the guidelines for placement of cables in cable carriers from TSUBAKI KABELSCHLEPP, s. page 72.

It is practical to install the cable carrier **without or with only little pretension**.

As no direct load occurs in the hanging arrangement, pretension causes the cable carrier to bulge outwards from the pretension. In addition to the visual aspect, this significantly increases the installation dimensions.

The **cables have to be fixed** to the driver and fixed point in such a way that their weight and the resulting dynamic load are absorbed only by the strain relief. Determining the cable carrier length see page 67.

Cable carrier

Cable carrier configuration

Configuration guidelines

Materials information

MONO series

QuickTrax® series

UNIFLEX Advanced series

TKP35 series

TKK series

EasyTrax® series

INV 5

Vertical arrangement, standing

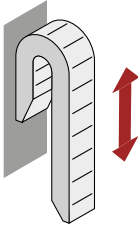

The cable carrier is mounted in such a way that parallel running of active run and passive run is ensured.

Determining the cable carrier length see page 67.

End connectors

The end connectors have to be mounted on the machine part (fixed point/driver) in such a way that the cable carrier cannot bend outwards, i.e. the connection must be **rigid**.

Connection height H

$$H = 2 KR + h_g$$

The distance between fixed point and driver connection corresponds to the selected bending radius.

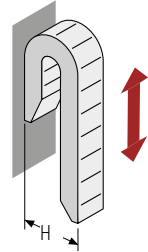

Support

The cable carrier generally has to be supported on the outside at the fixed point and at the driver.

The length of the support has to be defined depending on the additional load, the fill level, the travel length and the selected cable carrier.

Depending on the version of the support, the cable carriers are very often used with a slight pretension. If a short cable carrier does not require any support and if there is sufficient installation space, the standard pretension can be used. Use without pretension may result in the cable carrier bending. This is therefore not advisable.

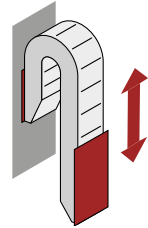

Direction of movement

Often, the complete unit additionally moves at a right angle to the vertical standing cable carrier. In this case, the cable carrier additionally has to be guided laterally.

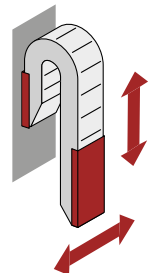

As a rule, only relatively short travel lengths can be implemented with the standing arrangement. If possible, the cable carrier should alternatively be used in a hanging arrangement. For this installation variant, the load on the overall system is significantly lower than with a standing arrangement.

INV 6

Horizontal arrangement, rotated 90° (straight)

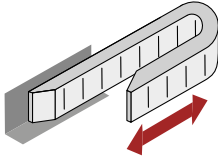

i The cable carrier used in normal horizontal direction is rotated by 90°, i.e. it glides on its outside or on special slide discs on a tray or in a channel. This arrangement can be implemented with almost all cable carrier types.

Application: Generally, cable carriers “rotated 90°” are used when the installation situation is primarily short on space with respect to height, preventing normal horizontal installation.

The installed cables have to be guided in the cross section of the cable carrier with **fixed separating elements** or in a **hole stay**, clearly separated from each other. This is the only way to prevent damage in the long run.

The technically best solution is the hole stay which provides the most secure guiding for the cables.

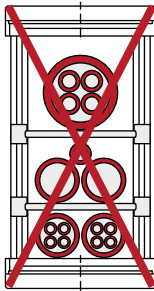

Frame stay with movable dividers

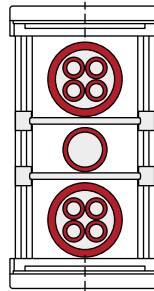

Frame stay with fixed dividers

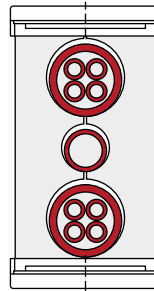

Best possible separation of cables in a hole stay

Systems for short travel lengths (with/without support)

The cable carriers can be used **unsupported** in the horizontal arrangement “rotated 90°” to a limited extent. The permitted unsupported length depends on the following parameters for this installation variant as well:

- » additional load q_z
- » bending radius KR
- » connection option
- » travel length L_S
- » cable carrier width B_k

If the additional load and the unsupported length are too high, the cable carrier has to be supported on one side or overall.

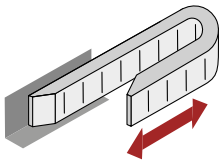

System without support

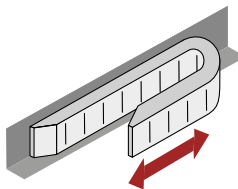

System with single-sided support

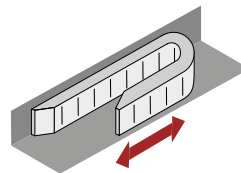

System with overall support

Subject to change without notice.

Configuration guidelines	Cable carrier
	Cable carrier configuration
Materials information	
MONO series	
QuickTrax® series	
UNIFLEX Advanced series	
TKP35 series	
TKK series	
EasyTrax® series	

System for long travel lengths (gliding in a guide channel)

Plastic cable carriers can be used for travel lengths far over 100 m with the arrangement "rotated 90° – straight".

Over a period of more than 65 years, we have built multiple systems with the arrangement "single-sided" or "opposite" with or without special auxiliary fixtures.

Single-sided arrangement (with stepped guide channel)

b_{KA} = channel width of narrow section
 l_{KA} = length of narrowed channel

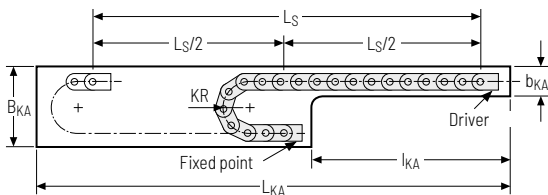

Opposite arrangement

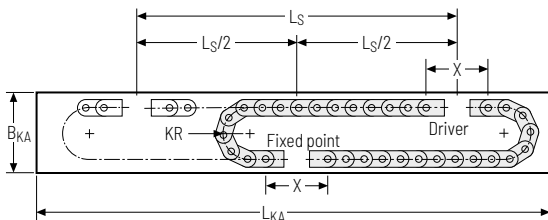

The cable carrier "rotated 90°" for long travel lengths **must** be guided in a channel. The material and texture of the channel base must be selected so they ensure low-wear travel with the lowest possible friction forces.

For long travel lengths, the cable carriers are used without pretension.

For **steel cable carriers**, corresponding gliding and guiding elements are mounted on the outside and/or inside of the side band, preventing grinding along the channel walls and ensuring smooth running of the system.

Support and guiding elements (combination examples):

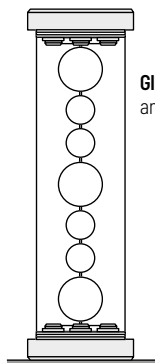

Gliders on upper and lower side band

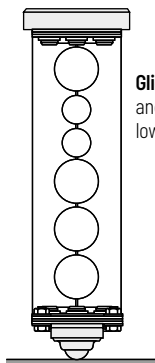

Gliders on the top and domes on the lower side band

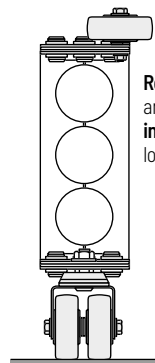

Rollers on the top and **double steering rollers** on the lower side band

INV 7

Horizontal arrangement, rotated 90° (circular)

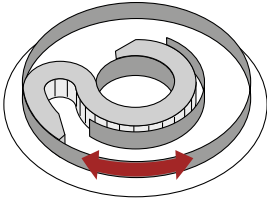

i For this arrangement, the cable carrier rotated 90° is connected to machine parts which carry out a circular movement.

The combination of bending radius KR and reverse bending radius RKR causes the cable carrier to move in two circular directions in a targeted and defined manner.

The cable carrier system is connected to the inner and outer rings of a guide channel. The rotating ring (inside or outside) is the driver connection.

Application: Generally, cable carriers in this arrangement always have to be guided in a channel. The driver can be positioned inside or outside.

A special chain link design is required to allow the cable carrier to execute a circular movement.

The installed cables have to be guided in the cross section of the cable carrier with **fixed separating elements** or in a **hole stay**, clearly separated from each other. This is the only way to prevent damage in the long run.

The technically best solution is the hole stay which provides the most secure guiding for the cables.

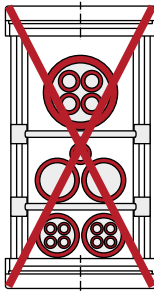

Frame stay with movable dividers

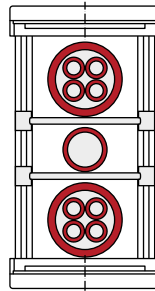

Frame stay with fixed dividers

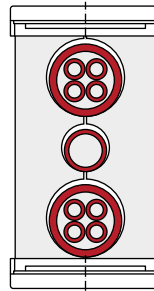

Best possible separation of cables in a hole stay

Due to the strong relative displacement and the continuously changing radius ratios, cables should only be installed in one layer to ensure maximum service life.

For **steel cable carriers**, corresponding gliding and guiding elements are mounted on the outside and/or inside of the side band, preventing grinding along the channel walls and ensuring smooth running of the system (see page 84).

Cable carrier
Cable carrier configuration
Configuration guidelines
Materials information
MONO series
QuickTrax® series
UNIFLEX Advanced series
TKP35 series
TKK series
EasyTrax® series



TSUBAKI KABELSCHLEPP technical support

If you have any questions about cable carriers or technical details please contact our technical support service at technik@kabelschlepp.de. We will be happy to help you.

Cable carrier

Cable carrier configuration

Configuration guidelines

Materials information

MONO series

QuickTrax® series

UNIFLEX Advanced series

TKP35 series

TKK series

EasyTrax® series

Single-sided arrangement

with offset guide channel (schematic diagram)

The cable carrier system shown here has the driver on the inner radius. There are also frequent applications where the driver has to be positioned on the outer radius.

To ensure sufficient guiding of the cable carrier in this case, moving guide plates are required for larger angles of rotation. As this version is more complex, the "inside rotating circular arrangement" should be preferred.

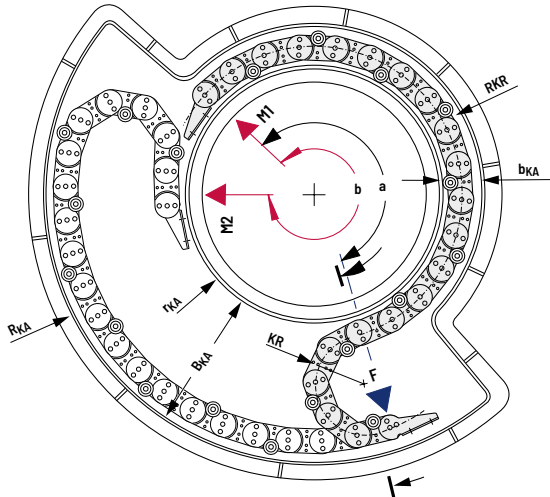

Opposite arrangement

with guide carriage (schematic diagram)

For opposite arrangements, a moving support fixture or a guide carriage has to be positioned in the channel due to the combination of KR and RKR.

Coupling of multiple circular systems is possible for angles of rotation over 500°.

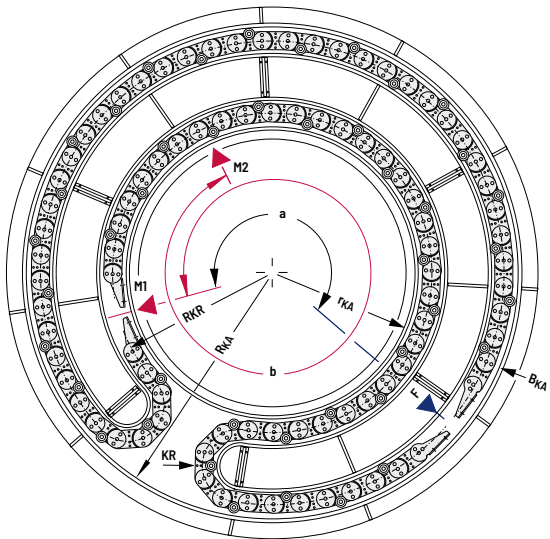

Abbreviated symbols:

- a = fixed point angle
- b = travel length
- B_E = width of cable carrier
- b_{KA} = channel width of narrow section
- B_{KA} = channel width
- H_E = height of cable carrier
- H_{KA} = height of the guide channel
- r_{KA} = channel radius - inside
- R_{KA} = channel radius - outside
- F = fixed point
- M1 = driver end position 1
- M2 = driver end position 2

Due to the variety of configuration options for this installation variant, we recommend contacting our technical support. We require the following parameters for preparing a solution:

- » inner diameter
- » outer diameter
- » travel length (angle of rotation)
- » single-sided or opposite arrangement?
- » driver on inner or outer radius? (inner radius preferred for single-sided arrangement)
- » restrictions for the installation space? (e.g. installation height)
- » cable list
- » environmental conditions (e.g. chips, dirt)

INV 8

Horizontal arrangement, rotated 90° (rolled)

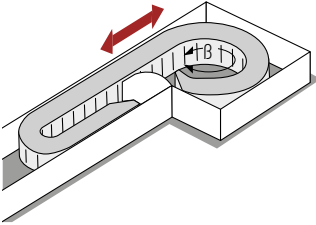

i For this arrangement, the cable carrier rotated 90° is connected to a consuming unit which carries out a circular movement. The travel length "B" is indicated in degrees!

Application: The application is designed for circular movements which are wound on a rotating body. This type of cable carrier is preferred for smaller systems, usually with large movement angles.

A standard cable carrier is used. A reverse bending radius is not required. The winding of the carrier limits the angle of rotation to approx. $B = 270^\circ$. For the implementation of larger angles of rotation, additional guide plates are required to prevent a collision on the driver. This application is practically a combination of installation variants 6 and 7. Accordingly, similar configuration criteria are used.

INV 9

Horizontal-vertical combined arrangement

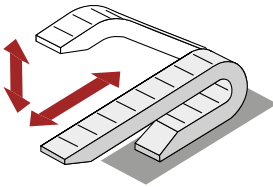

i Our cable carriers can also be used for combined horizontal/vertical movements.

This arrangement requires no special technical preconditions, but calculation of the cable carrier length is more complex and should be carried out by our technical support.

INV 10

Unsupported arrangement, nested

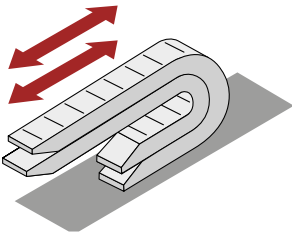

i This arrangement is possible for all cable carriers. If the available space do not permit installation of a cable carrier due to the required width, the system can be configured in a **nested** arrangement.

For smooth running, it has to be ensured that both cable carriers can move freely. This means sufficient distance between the upper run (min. 20 mm, depending on cable carrier type) and the carrier bends (min. half of chain link height).

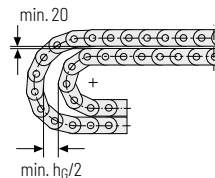

For long steel cable carriers there is an option for positioning guide plates at the side band of the outer carrier to ensure alignment of the inner carrier.

INV 11

Zig-zag arrangement

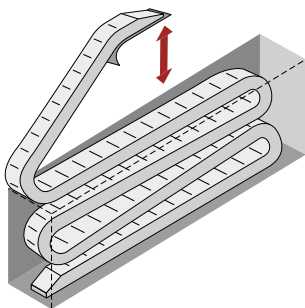

For some areas of application (e.g. stage and storage systems), it is often not possible to use a vertical hanging or standing cable carrier due to space restrictions. The so-called zig-zag arrangement is used in these cases.

As several bends fold on top of one another, the cable carrier has to be guided in all directions and therefore settles into a type of basket or sheet steel housing.

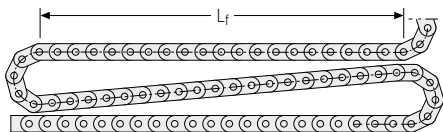

The following parameters are required for dimensioning the system:

- » travel length
- » travel speed
- » cables installed
- » minimum bending radius of guided cables
- » maximum permitted basket dimensions (length, width)
- » maximum permitted height

When dimensioning the basket length, ensure that the unsupported length L_f of the selected cable carrier is not exceeded. Depending on the length and weight of the cable carrier, supporting the bend on the driver with a bent plate is a measure which has a positive effect on the service life.

INV 12

Vertical arrangement, hanging with support bolt

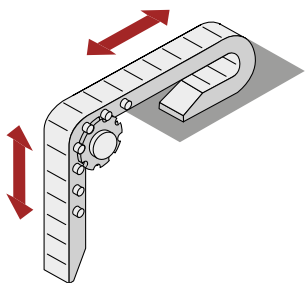

The vertical arrangement of the cable carrier with additional support elements offers the option of using the cable carrier as a lifting element for the attached system parts (e.g. operating panels, manipulators).

The cable carrier is driven via chain wheels. The pitch circle diameter has to be equal to or greater than the selected bending radius of the cable carrier. The drive is motorized or via a counterweight.

Due to the great number of configuration aspects, we would ask you to contact our technical support.

Cable carrier

Cable carrier configuration

Configuration guidelines

Materials information

MONO series

QuickTrax® series

UNIFLEX Advanced series

TKP35 series

TKK series

EasyTrax® series

INV 13

Horizontal arrangement, curled

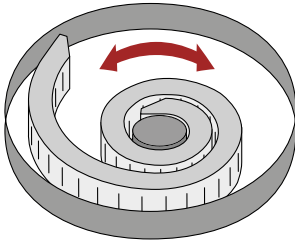

i In some cases, a large angle of rotation cannot be implemented with one of the usual applications for circular movements. In these cases, an examination with regard to the options for curling up the cable carrier is recommended.

A standard cable carrier can be used, but a relatively large installation space is required for curling up the configuration.

The rotation in this application is limited by a maximum double wrapping of the inner diameter. Multiple wrappings cause the cable carrier to jam.

INV 14

Vertically rotating arrangement, hanging

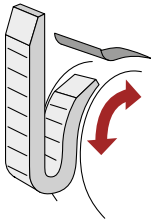

i This installation variant is often used for swiveled drums and turning devices.

The part rotating around the diameter requires chain links with KR and RKR in this area.

If the angle of rotation is over 180° (depending on the arrangement), an additional guide plate is required on the outer radius to prevent the cable carrier from tipping over.

INV 15

Roller chain

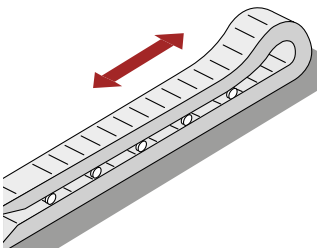

i Roller chains are primarily used where very long travel lengths lead to very high push and pull forces and gliding cable carriers reach their limits. The most effective installation variant is the RSC (rail supported carrier) system. This is a cable carrier where the design in combination with an optimized guide channel ensures 100 % roller operation over the entire travel length. This results in minimum mechanical load and a low noise level.

This makes the system suitable not only for extremely long travel lengths, but also for travel speeds over 5 m/s.

Despite the roller design, the RSC system can be fully wound on a reel and is therefore ideal for complete solutions with inserted cables for long travel lengths.

Dimensioning is similarly easy as for a gliding cable carrier. For effective and fast implementation, especially for large projects, we can offer our expert help.

Cable carrier

Cable carrier configuration

Configuration guidelines

Materials information

MONO series

QuickTrax® series

UNIFLEX Advanced series

TKP35 series

TKK series

EasyTrax® series

INV 16

Arrangement with continuous support structure

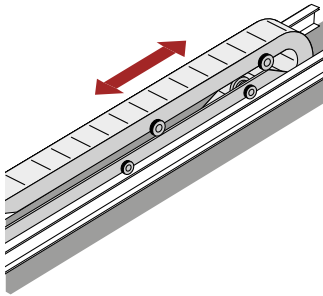

While this installation variant is also possible for plastic cable carriers, it is primarily used for steel cable carriers.

If the technical conditions no longer permit the use of a gliding cable carrier or a cable carrier with support rollers with regard to travel length, acceleration or speed, a so-called cable carrier unit with a continuous moving support structure can be used.

Cable carrier units are particularly suitable for use with large travel lengths and high travel speeds under rough operating conditions and heavy loads. There is a variety of different versions of this installation variant. As an example, we present the most used type 225 here.

Due to the complexity, this type of cable carrier system should be dimensioned in cooperation with our engineers.

Cable carrier installation type 225

The cable carrier installation is either configured as a single-sided system with one cable carrier installation or as an opposite arrangement with two cable carriers.

A carriage guided on rollers in a running frame supports the cable carriers along their entire length. The support structure is moved in both directions with a cable pull system which is attached to the rolling carriage system. Due to the roller support and roller guiding of the cable carriers on the

support carriage and of the support carriage on the running frame, only minimal friction forces are generated in the system. Systems with the following limit values have been supplied so far:

- » longest travel length: $L_{S \max.} = 222 \text{ m}$
- » highest travel speed: $v_{\max} = 4 \text{ m/s}$
- » greatest travel acceleration: $a_{\max} = 8 \text{ m/s}^2$

Single-sided arrangement

(schematic diagram)

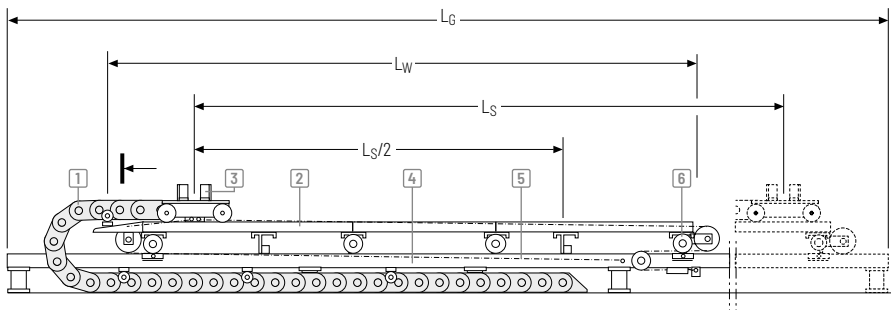

Opposite arrangement (schematic diagram)

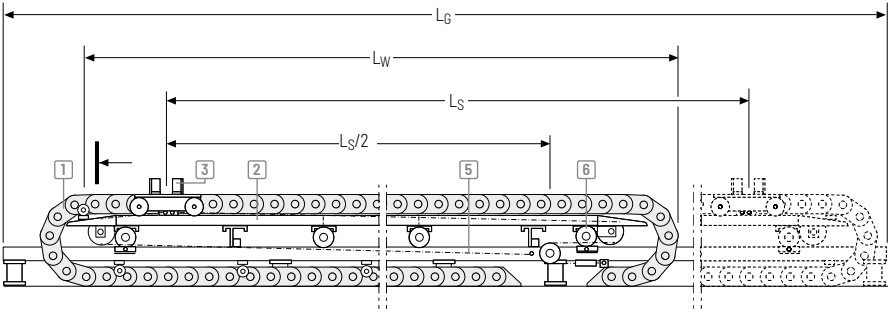

Cross section of the cable carrier installation

Abbreviated symbols:

- B_D = clear width in the running frame
- B_G = running frame width
- B_k = cable carrier width
- B_W = support carriage width (max. width)
- H = installation height of the cable carrier(s)
- H_G = running frame height
- L_G = running frame length
- L_S = travel length
- L_W = support carriage length

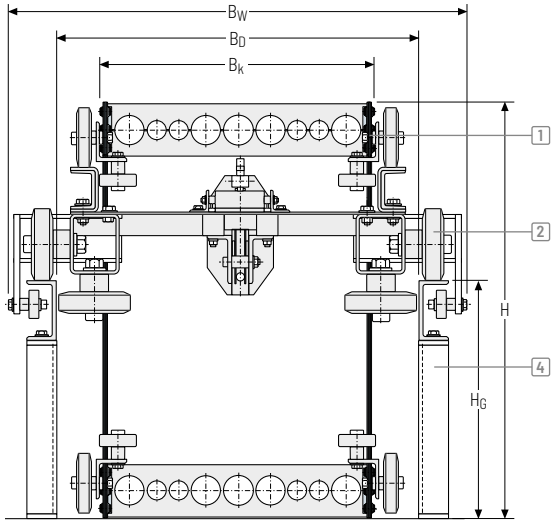

The cable carrier installation type 225 consists of the following assemblies:

- 1 Cable carrier(s)**
with laterally attached track rollers and guide rollers
- 2 Support carriage** with track rollers and guide rollers supporting across the entire length
- 3 Rolling carriage system** with track rollers and guide rollers
- 4 Running frame**
- 5 Steel cable**
- 6 Cable tensioning roller**
- 7 Tensioning device**

Cable carrier

Cable carrier configuration

Configuration guidelines

Materials information

MONO series

QuickTrax® series

UNIFLEX Advanced series

TKP35 series

TKK series

EasyTrax® series

Content

01

Plastics..... page 94

- » Standard materials
- » Special materials
- » Material code
- » Colors
- » Chemical resistance
- » Environmental conditions

02

Metals..... page 99

- » Steel and aluminum properties
- » Area of application according to product series

03

Application temperatures..... page 100

- » Application temperatures according to material

04

Tribology..... page 101

- » Cost savings from low jacket abrasion

05

ATEX/ESD..... page 102

- » Protection against explosions
- » Conductive ESD cable carriers

Cable carrier

Cable carrier
configurationConfiguration
guidelinesMaterials
informationMOND
seriesQuickTrax®
seriesUNIFLEX
Advanced
seriesTKP35
seriesTKK
seriesEasyTrax®
series

Material selection

The composition of different materials allows customers to select the individual cable carrier for their application.

The selection of the right material is often linked to the following parameters:

- » Friction values
- » Friction partners
- » Ambient temperature
- » Robustness
- » Optics
- » Noise emission
- » Contamination
- » Humidity

01 Plastics

1.1 Standard materials

The standard plastic used for most of our product is a PA6 GF35.

This material has the best price-performance ratio, confirmed by countless internal tests and by our customers, to meet the requirements for modern cable carriers.



The use for standard products is structured as follows (information refers to the side bands and other components, see p. 95):

Series	Plastic for main components	Series	Plastic for main components
BASIC-LINE		VARIO-LINE	
MONO series	PA6 GF35	M series	PA6 GF35
QuickTrax® series	PA6 GF35 + PA6	XL series	PA6 GF35
UNIFLEX Advanced series	PA6 GF35	QUANTUM® series	PP
TKP35 series	PA6 GF30	TKR series	PA66
TKK series	PA6 GF35	PLASTIC-TUBES	
BASIC-LINE^{PLUS}		TKA series	PA6 GF35
EasyTrax® series	PA6 GF35 + PA6	MT series	PA6 GF35
PROTUM® series	PA6 + TPE	XLT series	PA6 GF35
VARIO-LINE		3D-LINE	
K series	PA6 GF35	ROBOTRAX® system	POM
UNIFLEX Advanced series	PA6 GF35		

1.2 Special materials

Special materials are modified plastics which are suitable for applications outside the standard. There are different variants for a variety of different requirements. The following table can help with the selection of the correct material for the application at hand. It has to be noted that not all materials can be used in all products. Please contact us.

Plastic type	Property	Code
PA6 GF35	Standard material for common applications Performance range according to material data sheet	7422 7370
PA6.6 GF	Special material for ATEX application following ATEX Directive 2014/34/EU	7400
PA66 GF50	Standard material for UMB	7419
POM	Standard material for ROBOTRAX®	7412
PA6 GF30	Impact-strength-modified special material for use in cold environments	7488
PA46 GF30	Modified special material for use in hot temperature areas	7341
PA66 GF25	Modified special material with special requirements for fire behavior (VO)	7414
PA66 CF	Modified special material with conducting properties for voltage (ESD)	7366

1.3 Material code

Codes are assigned to each plastic to differentiate between the different plastic materials. The code has four digits and can be identified as a simplified code on most plastic components. This is embossed into the component on a material dial at the side of the chain links of the cable carrier.

Code	Coding	Material
7422	AD	PA6 GF35











Example of material dial

Cable carrier
Cable carrier configuration
Configuration guidelines
Materials information
MONO series
QuickTrax® series
UNIFLEX Advanced series
TKP35 series
TKK series
EasyTrax® series

1.4 Colors

The price is always based on the colour black. In addition, there are other individual colours in our assortment, which are manufactured article-related and belong to the standard. For all other colours additional costs, minimum quantities and delivery times have to be considered.

Colours which are not included in the table are, if technically possible, individually calculated according to article and quantity. All technical values regarding stability and material properties apply only to black versions. Coloured cable carriers and articles made of special material have changed properties and are not always available in all colours for technical reasons.

	RAL-Farbbezeichnung	Code	ähnlich RAL-Nr.	Grundmaterial	
Configuration guidelines		Sulfur yellow	7380	1016	7423
		Signal red	7342	3001	7423
		Ruby red	7384	3003	7423
Materials information		Traffic blue	7373	5013	7423
		Sky blue	7494	5015	7423
		Night blue	7344	5022	7423
		Turquoise green	7343	6016	7423
		Squirrel gray	7377	7000	7423
		Iron grey	7339	7011	7423
MONO series		Light Grey	7378	7035	7423
		Agate grey	7372	7038	7423
		Window gray	7497	7040	7423
QuickTrax® series		Traffic grey A	7367	7042	7423
		Traffic grey A	7495	7042	7423
		Tele grey I	7354	7045	7423
		Signal white	7371	9003	7423
UNIFLEX Advanced series		Jet black	7336	9005	7423
		White aluminum	7397	9006	7423
		Pure White	7353	9010	7423
TKP35 series		Traffic White	7486	9016	7423
		Traffic White	7486	9016	7423
TKK series					
EasyTrax® series					

1.5 Chemical resistance of the standard material

KS 7422

This resistance table shows that the use of plastic cable carriers is not recommended for any acidic media.

In these cases, we recommend using our proven stainless steel cable carriers!

Abbreviated symbols:

- resistant
 - limited resistance
 - ⊗ not resistant
 - soluble
- GL = saturated aqueous solution
 H = standard commercial grade
 TR = technically pure

Medium	Mass percentage	Temperature in °C	Resistance
Acetone	TR		●
Formic acid	10		⊗
Ammonia (liquid)	TR	+ 70	■
Ammonia		+ 20	●
Petrol	H	+ 85	●
Benzene	H		●
Bitumen	H		●
Boric acid (aqueous)	H		●
Butyric acid (aqueous)	20		●
Calcium chloride (aqueous)	GL	+ 23	●
Chlorine, hydrocarbon			●
Chlorine, chlorinated water	H		⊗
Chromic acid (aqueous)	10		⊗
Diesel oil	H		●
Acetic acid (aqueous conc.)	95		⊗
Acetic acid (aqueous)	10		■
Ethanol	40		●
Ethyl acetate	TR		●
Paint and varnish			●
Grease and wax	H		●
Liquid gas (DIN 51622)			●
Hydrofluorocarbons			●
Formaldehyde and polymac.	TR		●
Formaldehyde (aqueous)	30		■
Hydraulic oil	H		●
Potash lye	10		●
Potassium chloride (aqueous)	10		●
Potassium nitrate (aqueous)	10		●
Methyl acetate	TR		●
Milk	H		●
Lactic acid (aqueous)	10		●
Lactic acid	90		⊗
Mineral oil	H		●
Sodium carbonate (aqueous)	10		●
Oil/cooking oil, lubricating oil	H		●
Oleic acid	H		●
Paraffin, paraffin oil	H		●
Polyester resin	H		●
Propane, propene	TR		●
Mercury	TR		●
Hydrochloric acid (aqueous)	> 20		●
Hydrochloric acid	2		⊗
Lubricant, cooking grease	H		●
Vaseline	H		●
Tartartic acid (aqueous)	10		●
Tartartic acid	50		■
Xylene	TR		●
Sulfuric acid	98		●

More information on request.
Please contact us!

Cable carrier

Cable carrier configuration

Configuration guidelines

Materials information

MONO series

QuickTrax® series

UNIFLEX Advanced series

TKP35 series

TKK series

EasyTrax® series

1.6 Ambient conditions for standard materials



Weather

The plastic used by TSUBAKI KABELSCHLEPP is ideal for outdoor use. The mechanical properties of the cable carriers are not affected.

7422 is UV resistant!



Radiation resistance

Depending on the intensity, plastic cable carriers can also be used conditionally under the influence of radioactive radiation. If possible, we recommend the use of steel cable carriers.

Please consult us in any case!



Burning behavior

The plastic used by TSUBAKI KABELSCHLEPP was tested as per UL 94.

More information on request. **Please contact us!**

1.7 Ambient conditions for special purpose materials



High-temperature resistance

Our special purpose material 7341 is high-temperature resistant and therefore ideal for use in high-temperature areas. Please contact us, as not all special purpose materials are available for all cable carrier types and temperature ranges.

More information on request. **Please contact us!**

Thermal properties	Permissible temperature range
Continuous ambient temperature	+20 to +150 °C
Up to max. 5000 hours	up to +185 °C
Short-term	up to +285 °C



Cold store resistance

Our special purpose material 7488 is low-temperature resistant and therefore ideal for use in cold stores and extremely low temperatures.

More information on request. **Please contact us!**

Thermal properties	Permissible temperature range
Continuous ambient temperature	-50 to +40 °C

These cable carriers can only be manufactured in the color yellowish/white (transparent).

02 Metals

2.1 Steel and aluminum properties

Type	Use	Code
Steel		
Galvanized steel	All applications which do not require any special corrosion protection, especially for general machinery and plants, as well as in areas of application where plastic cable carriers are not permitted due to their load capacity, strain, elasticity and ambient conditions (link plates, channel parts, connecting elements, connections, etc.)	St vz
Hardened steel, black coated		Sb
Stainless steel similar to 1.4301; AISI304	Same areas of application as galvanized steel, but with special requirements for corrosion resistance (link plates, channel parts, connecting elements, connections)	ER1
Stainless steel similar to 1.4571; 1.4404; AISI316T; AISI316L	Same areas of application such as galvanized steel, but with special suitability for ambient conditions with salt concentration, e.g.: ports, food compatibility (link plates, channel parts, connecting elements, connections)	ER 1S
Stainless steel similar to 1.4462; 318LN	High strength for applications in the chemical and petrochemical industry, offshore, textile industry, cellulose production, dyeworks, paint industry, synthetic resin industry, rubber industry, shipbuilding	ER 2
Light alloy		
Aluminum alloy	Perfect gliding partner for cables and hoses, very good cold resistance and salt-water resistance (stays, hole stays, height separations)	Al

2.2 Area of application according to product series

Some products and product groups consist of a variety of different materials. The use for the metals is structured as follows (information refers to the side bands and other components):

Series	Main metal components
STEEL-LINE	
LS series	Sb
LSX series	ER1
S series	St vz
SX series	ER1, ER1S, ER2
Metal stays, covers	Al

Cable carrier

Cable carrier configuration

Configuration guidelines

Materials information

MONO series

QuickTrax® series

UNIFLEX Advanced series

TKP35 series

TKK series

EasyTrax® series

03 Application temperatures

Cable carrier

Cable carrier
configurationConfiguration
guidelinesMaterials
informationMONO
seriesQuickTrax®
seriesUNIFLEX
Advanced
seriesTKP35
seriesTKK
seriesEasyTrax®
series

Our materials have different application temperatures. The following table shows the application temperatures for the most frequently used materials.

Material	Upper continuous application temperature	Lower continuous application temperature
PA6 GF35	+ 100 °C	- 30 °C
Galvanized steel	+ 210 °C	- 40 °C
ER1	+ 500 °C	- 80 °C
ERIS	+ 550 °C	- 80 °C
ER2	+ 250 °C	- 100 °C
Aluminum	+ 140 °C	- 80 °C



TSUBAKI KABELSCHLEPP technical support

If you have any questions about cable carriers or technical details, please contact our technical support at technik@kabelschlepp.de. We will be happy to help you.



04 Tribology

Low jacket abrasion is an essential prerequisite for a long service life of the cables in a cable carrier. In addition to the jacket material, the stay material as the support surface for the cables affects jacket abrasion. We have analyzed the abrasion on different cables with different stay materials in extensive tests.

Aluminum stays proved to be a gentle support for the cable jackets. This result does not depend on the cable manufacturer and applies to all jacket materials tested. Jacket abrasion is of minor importance for many standard applications. Simple solid plastic cable carriers from BASIC-LINE and BASIC-LINE^{PLUS} can be used without problems in these cases.

For more challenging applications with large relative movements between stay and cable, the outer cable jacket is subject to a high level of wear through abrasion. In these cases, we recommend using cable carriers with aluminum stays to increase the service life of the cables.

Save costs through lower jacket abrasion on cables

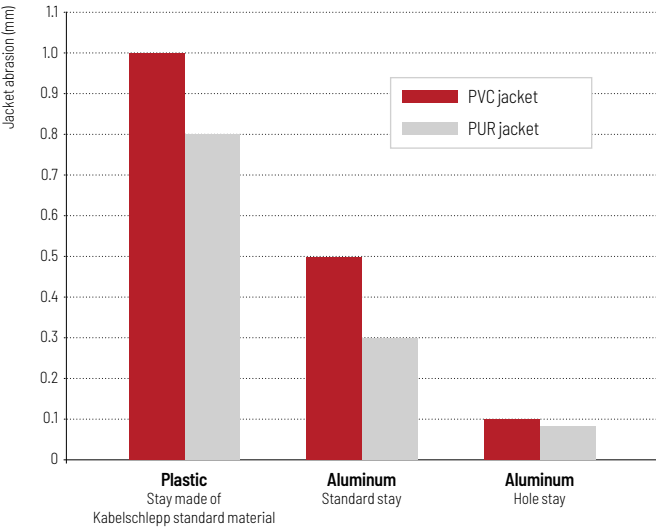

Abrasion from 3 million movement cycles and a relative displacement between stay and cable of 10 mm.

In addition to reducing abrasion, aluminum is ideal as a stay material due to its high strength and low intrinsic weight. Cable carrier widths up to 1000 mm can be achieved without putting special strain on the cable carrier through additional weight.



Cable carrier

Cable carrier configuration

Configuration guidelines

Materials information

MONO series

QuickTrax® series

UNIFLEX Advanced series

TKP35 series

TKK series

EasyTrax® series

05 ATEX / ESD

Cable carrier

Cable carrier
configurationConfiguration
guidelinesMaterials
informationMONO
seriesQuickTrax®
seriesUNIFLEX
Advanced
seriesTKP35
seriesTKK
seriesEasyTrax®
series

5.1 Protection against explosions

The Atex 2014/34/EU is the applicable EU explosion protection directive which must be fulfilled by devices and protection systems for use in explosive atmospheres. This also requires the prevention of explosive electrostatic discharge (ESD).

One method for preventing explosive ESD is a sufficiently low surface resistance of the affected component. Low surface resistance of a material acts like an electric short circuit and leads to a charge compensation of charged surfaces. This means that no explosion can be triggered in an explosive atmosphere.

Our special material 7400 was tested and certified by the National Metrology Institute of Germany (PTB) in Braunschweig. The surface resistance of less than $10^6 \Omega$ is clearly below the maximum limit value of $10^9 \Omega$ required in applicable regulations. This means that this material can be used for all devices and protection systems in explosive atmospheres without limitations.

Please contact us if you require KABELSCHLEPP cable carriers for use in explosive atmospheres. In addition to competent advice, we can provide you with all documentation required by the ATEX Directive, such as Declaration of Conformity, operating instructions, etc.



Our explosion-protected cable carriers can be used for all devices which are covered by the ATEX Directive 2014/34/EU.

5.2 Conductive ESD cable carriers

Electrostatic discharge (ESD) is a hazard when manufacturing and processing electronic components. If no adequate protection is provided, damage can occur. The requirements for materials, tools and therefore also cable carriers are defined in the ESD standard DIN EN 61340.

Our proven ESD cable carriers, which are made of our special material 7366, meet the requirements of the ESD standards with regard to conductance and resistance behavior.

Increasing miniaturization for semiconductor components leads to greater ESD sensitivity and therefore requires better ESD protection.

This requires a lower surface resistance of the plastic cable carriers used for handling and assembly.



Our ESD cable carriers meet the requirements of the ESD standards DIN EN 61340-5-1 and DIN EN 61340-5-2.



Low surface resistance through nanotubes

Our ESD material is modified through nano technology and equipped with carbon nanotubes, among other things.

Carbon nanotubes are used as a functional filler. Due to their graphitic surface structure they have a high electric conductance. Cable carriers made from this material have a surface resistance of $\leq 10^5 \Omega$ which far exceeds the values required by the ESD standard.

Carbon nanotubes have a diameter of only a few nanometers and a length of up to a few millimeters.

Cable carriers with nanotubes

- » Low surface resistance: $\leq 10^5 \Omega$
- » Significantly exceed the values required by the ESD standard
- » Areas of application: chip handling, semiconductor manufacturing, electronics manufacturing, solar technology

Higher conductance of the complete cable carrier

The large specific surface and the extremely even distribution of the nanotubes in the material achieves good conductance even at the contact points between the chain links and therefore across the entire cable carrier length. A resistance of $\leq 10^5 \Omega$ was measured on a KABELSCHLEPP cable carrier of type UA 1455.030.078.052 with a length of 88 links (= 4 m).

Quality with factory certificate

Each ESD cable carrier with nanotubes technology is supplied with a KABELSCHLEPP factory certificate to certify its quality.



High stability

The modification of the fiberglass-reinforced material with nanotubes makes the cable carriers even sturdier.

The nanotubes have a sixth of the weight of steel but their tensile strength is multiple times higher.

This also increases the mechanical properties while retaining the high elasticity of the cable carriers made of ESD material. This effect is also applied successfully in numerous sports equipment, e.g. tennis rackets, bicycles and golf clubs.

High conductance even after one hundred thousand movement cycles

The test shows that the surface resistance of the complete cable carrier decreases during the running-in phase and then remains constant at $10^4 \Omega$.

Surface resistance
ET UA 1455.030.078.052-4004 with ESD material

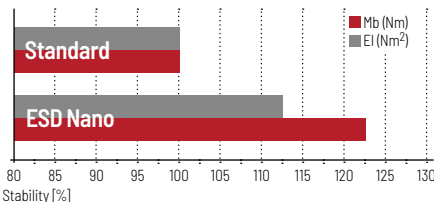
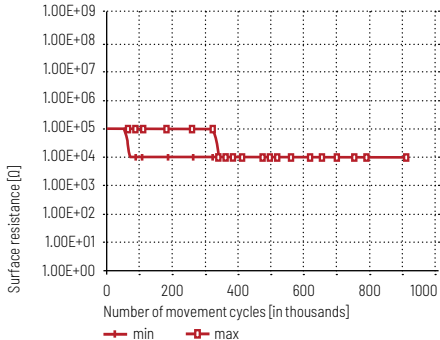

Subject to change without notice.

Cable carrier
Cable carrier configuration
Configuration guidelines
Materials information
MONO series
QuickTrax® series
UNIFLEX Advanced series
TKP35 series
TKK series
EasyTrax® series

Cable carrier

Cable carrier
configurationConfiguration
guidelinesMaterials
informationMONO
seriesQuickTrax®
seriesUNIFLEX
Advanced
seriesTKP35
seriesTKK
seriesEasyTrax®
series

BASIC-LINE

Solid plastic cable carriers with fixed chain widths

The BASIC LINE comprises a variety of different product types with pre-defined cable carrier widths. All combine robustness and reliability with an attractive price-performance ratio. Fast and easy installation of cables and hoses is another distinguishing feature of these cable carriers.

- » Cost-effective solutions for standard applications
- » Types and designs with fixed or opening crossbars
- » Numerous types and designs available immediately from our warehouse
- » Fast installation of cables and hoses
- » Ideal for short travel lengths and high travel speeds
- » Types for long travel lengths available



MONO series Page 106

Cable carriers for standard applications



QuickTrax® series Page 126

Compact and cost-effective cable carriers in two-component technology



UNIFLEX Advanced series Page 144

Light, quiet all-rounder with a wide range of applications

Not all technical data and parameters are reached in each individual case, but are depending on the respective type of application and product configuration. Legally binding insofar as only the individual information provided for the specifically requested particular case. Please contact us - we will be happy to advise you!



Cable carrier

Cable carrier
configurationConfiguration
guidelinesMaterials
informationMONO
seriesQuickTrax®
seriesUNIFLEX
Advanced
seriesTKP35
seriesTKK
seriesEasyTrax®
series**TKP35 series** Page 212**Robust all-rounder
with variable inner distribution****TKK series** Page 222**Dirt-repellent cable carriers made of plastic**

MONO series

Cable carriers for
standard applications

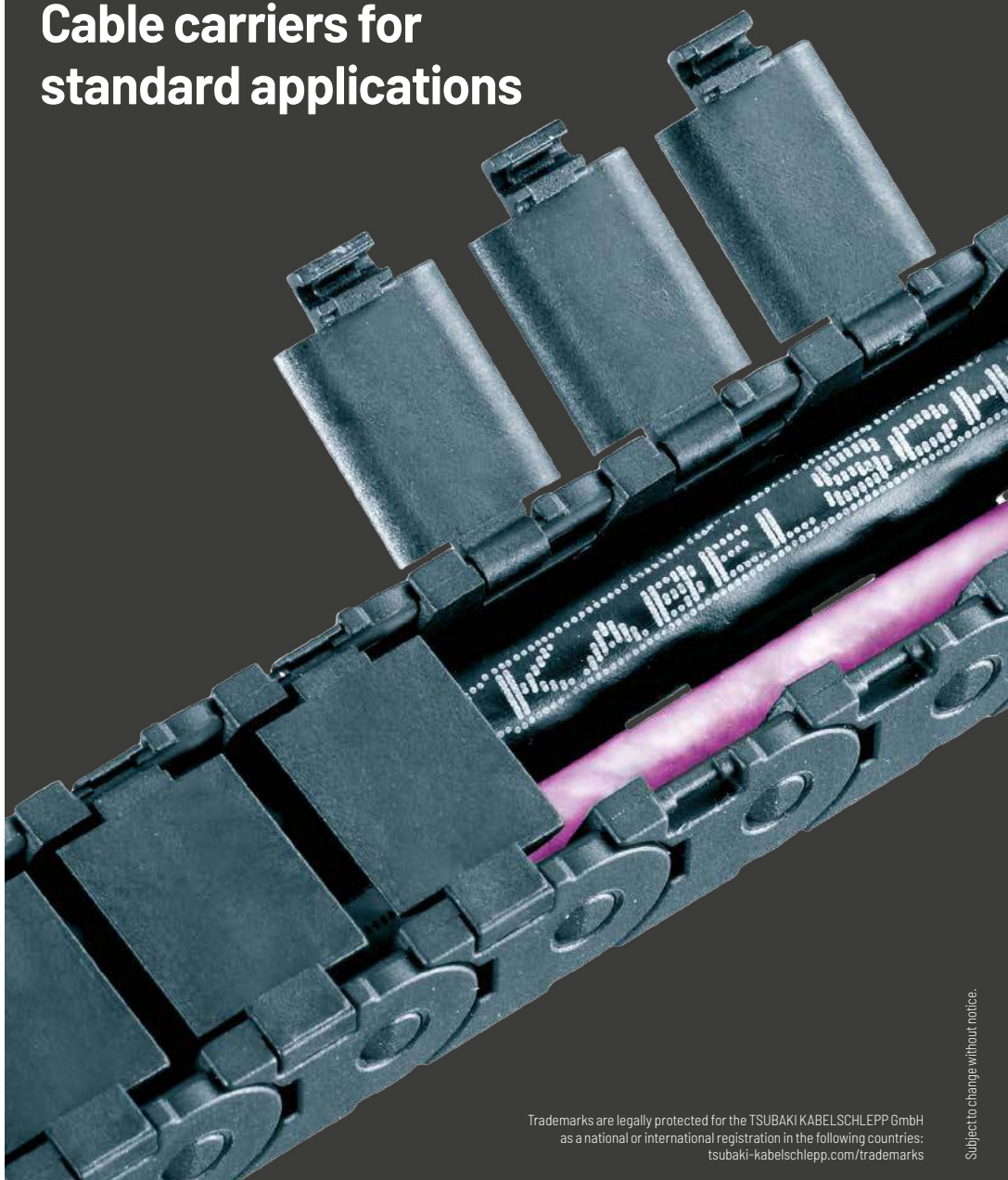

Trademarks are legally protected for the TSUBAKI KABELSCHLEPP GmbH
as a national or international registration in the following countries:
tsubaki-kabelschlepp.com/trademarks

Subject to change without notice.

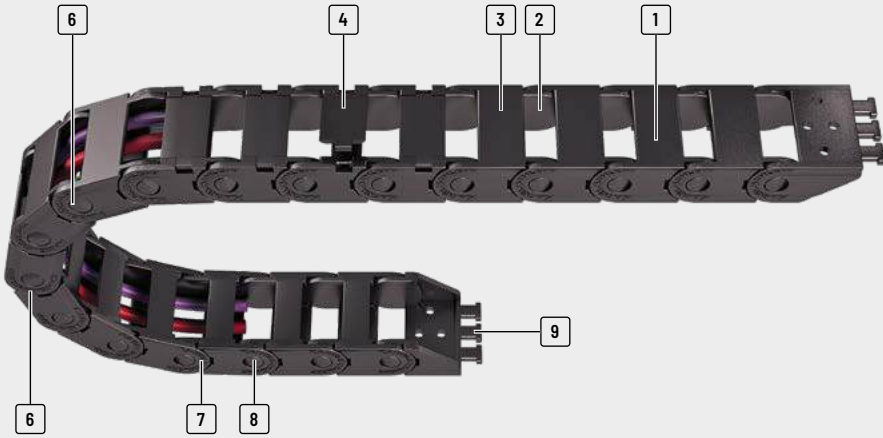

- 1 Plastic chain links
- 2 Inside space is gentle on the cables - no interfering edges
- 3 Types with single-part links
- 4 Types with opening crossbars
- 5 High torsional rigidity through large link surface
- 6 Extensive unsupported length and high additional loads through optimised stroke system
- 7 Easy to shorten and extend
- 8 Long service life through large bolt hole connection
- 9 End connectors with integrated strain relief

Features

- » Cost-effective cable carrier
- » Easy and fast installation
- » Many types available immediately ex-stock world wide
- » Long service life
- » Great unsupported lengths compared to the unit size
- » High torsional rigidity
- » Easy to install



Small types for narrow installation spaces



Fast shortening/extending with push-to-connect chain links



Different connection variants through simple reconnecting of the end connectors

Cable carrier

Cable carrier configuration

Configuration guidelines

Materials information

MONO series

QuickTrax® series

UNIFLEX Advanced series

TKP35 series

TKK series

EasyTrax® series

	Type	Opening variant	Stay variant	h_i	h_G	B_i	B_k	B_i - grid	t	KR	Additional load \leq [kg/m]	Cable- d_{max} [mm]
				[mm]	[mm]	[mm]	[mm]	[mm]	[mm]	[mm]		
Cable carrier												
Cable carrier configuration												
Configuration guidelines												
Materials information												
MONO series												
QuickTrax® series												
UNIFLEX Advanced series												
TKP35 series												
TKK series												
EasyTrax® series												
MONO 0130/..32/..34												
		0132	10	12.5	6 - 20	12 - 26	-	13	20 - 37	0.5	8	
		0130	10	12.5	6 - 20	12 - 26	-	13	20 - 37	0.5	8	
		0134	10	12.5	6 - 20	12 - 26	-	13	20 - 37	0.5	8	
MONO 0180/..82/..84												
		0182	15	18	10 - 40	18 - 48	-	18	28 - 50	1	12	
		0180	15	18	10 - 40	18 - 48	-	18	28 - 50	1	12	
		0184	15	18	10 - 40	18 - 48	-	18	28 - 50	1	12	
MONO 0202												
		0202	11	15	6 - 20	13 - 27	-	20	18 - 50	1.25	8.5	

Unsupported arrangement			Gliding arrangement			Inner Distribution				Movement			Page
Travel length ≤ [m]	$v_{max} \leq [m/s]$	$a_{max} \leq [m/s^2]$	Travel length ≤ [m]	$v_{max} \leq [m/s]$	$a_{max} \leq [m/s^2]$	TS0	TS1	TS2	TS3	vertical hanging or standing	lying on the side	rotating arrangement	
1.15	10	50	40	3	30	-	-	-	-	•	•	-	112
1.15	10	50	40	3	30	-	-	-	-	•	•	-	113
1.15	10	50	-	-	-	-	-	-	-	•	•	-	114
1.55	10	50	70	3	30	-	-	-	-	•	•	-	118
1.55	10	50	70	3	30	-	-	-	-	•	•	-	119
1.55	10	50	-	-	-	-	-	-	-	•	•	-	120
1.95	10	50	70	3	30	-	-	-	-	•	•	•	124

Cable carrier

Cable carrier configuration

Configuration guidelines

Materials information

MONO series

QuickTrax® series

UNIFLEX Advanced series

TKP35 series

TKK series

EasyTrax® series

0130/.32/.34



Pitch
13 mm



Inner height
10 mm



Inner widths
6 – 20 mm



Bending radii
20 – 37 mm

Types



Type 0132 page 112

Closed frame (design 020)

- » Weight optimised, closed plastic frame with high torsional rigidity.
- » **Outside/inside:** not openable.



Type 0130 page 113

Frame with outside opening crossbars (design 030)

- » Weight optimised plastic frame with high torsional rigidity.
- » Openable at any position.
- » **Outside:** openable.



Type 0134 page 114

Frame with inside opening crossbars (design 040)

- » Weight optimised plastic frame with high torsional rigidity.
- » Openable at any position.
- » **Inside:** openable.

Optimised cable carrier geometry:

Easy to shorten and extend

Long service life through large bolt hole connection

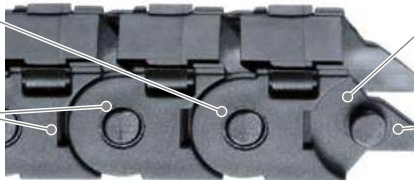

High torsional rigidity through large link surface

Extensive unsupported length and high additional loads through optimised stroke system

Unsupported arrangement

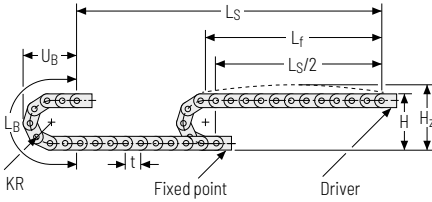





KR [mm]	H [mm]	H _z [mm]	L _B [mm]	U _B [mm]
20	52.5	62.5	89	40
28	68.5	78.5	114	48
37	86.5	96.5	142	57

Load diagram for unsupported length depending on the additional load.

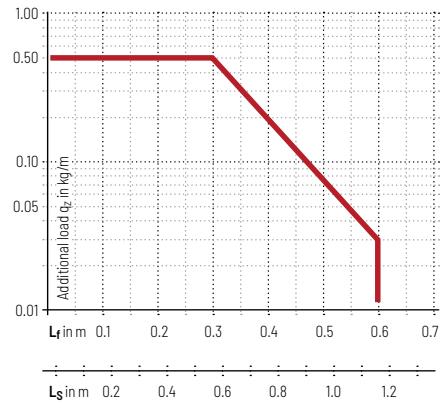
Sagging of the cable carrier is technically permitted for extended travel lengths, depending on the specific application.





Intrinsic cable carrier weight $q_k = 0.16 \text{ kg/m}$ with B_1 15 mm. For other inner widths, the maximum additional load changes.

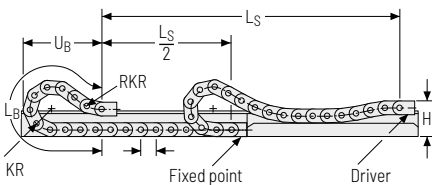

-  **Speed**
up to 10 m/s
-  **Acceleration**
up to 50 m/s^2
-  **Travel length**
up to 1.15 m
-  **Additional load**
up to 0.5 kg/m

Gliding arrangement



-  **Speed**
up to 3 m/s
-  **Acceleration**
up to 30 m/s^2
-  **Travel length**
up to 40 m
-  **Additional load**
up to 0.5 kg/m

 The gliding cable carrier must be guided in a channel. See p. 844.

Only designs 020 and 030 can be used for a gliding arrangement.

Cable carrier
Cable carrier configuration
Configuration guidelines
Materials information
MONO series
QuickTrax® series
UNIFLEX Advanced series
TKP35 series
TKK series
EasyTrax® series

Type 0132 – closed frame

- » Weight optimised, closed plastic frame with high torsional rigidity.
- » **Outside/inside:** not openable.



Stay arrangement on each chain link (**VS: fully-stayed**)



B₇₆ - 20 mm

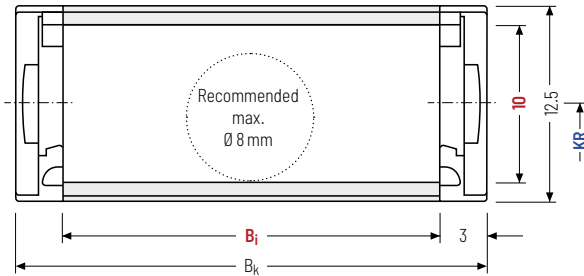

The maximum cable diameter strongly depends on the bending radius and the desired cable type. Please contact us.

Calculating the cable carrier length

Cable carrier length L_k

$$L_k \approx \frac{L_S}{2} + L_B$$

Cable carrier length L_k
rounded to pitch t

h_i [mm]	h_G [mm]	B_i [mm]			B_k [mm]	KR [mm]			q_k [kg/m]	
10	12.5	6	10	15	20	$B_i + 6$	20	28	37	0.091 - 0.162

Order example



MONO
Series

0132
Type

15
 B_i [mm]

28
 KR [mm]

390
 L_k [mm]

VS
Stay arrangement

Type 0130 - with outside opening crossbars

- » Weight optimised plastic frame with high torsional rigidity.
- » Openable at any position.
- » **Outside:** openable.



 Stay arrangement on each chain link (**VS: fully-stayed**)

 B₁ 6 - 20 mm

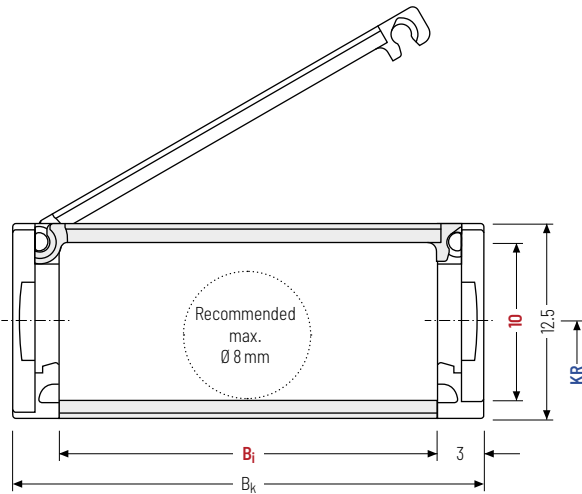

 The maximum cable diameter strongly depends on the bending radius and the desired cable type. Please contact us.

Calculating the cable carrier length

Cable carrier length L_k

$$L_k \approx \frac{L_S}{2} + L_B$$

Cable carrier length L_k rounded to pitch t

h_i [mm]	h_G [mm]	B_i [mm]				B_k [mm]	KR [mm]			q_k [kg/m]
10	12.5	6	10	15	20	$B_i + 6$	20	28	37	0.097 - 0.178

Order example

 **MONO** Series · **0130** Type · **15** B₁ [mm] · **28** KR [mm] · **390** L_k [mm] · **VS** Stay arrangement

Cable carrier

Cable carrier configuration

Configuration guidelines

Materials information

MONO series

QuickTrax® series

UNIFLEX Advanced series

TKP35 series

TKK series

EasyTrax® series

Type 0134 – with inside opening crossbars

- » Weight optimised plastic frame with high torsional rigidity.
- » Openable at any position.
- » **Outside:** openable.



Stay arrangement on each chain link (**VS: fully-stayed**)



B₇ 6 – 20 mm

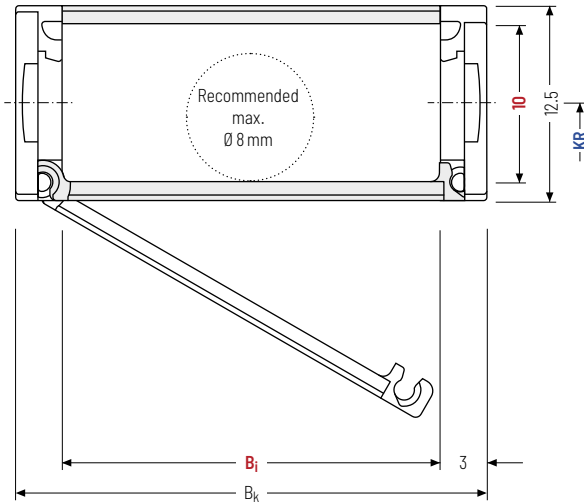

The maximum cable diameter strongly depends on the bending radius and the desired cable type. Please contact us.

Calculating the cable carrier length

Cable carrier length L_k

$$L_k \approx \frac{L_S}{2} + L_B$$

Cable carrier length L_k
rounded to pitch t

h_i [mm]	h_G [mm]	B_i [mm]			B_k [mm]	KR [mm]			q_k [kg/m]	
10	12.5	6	10	15	20	$B_i + 6$	20	28	37	0.099 – 0.132

Order example



MONO
Series

0134
Type

15
 B_i [mm]

28
 KR [mm]

390
 L_k [mm]

VS
Stay arrangement

Single-part end connectors – plastic
(with integrated strain relief)

The plastic end connectors can be connected **from above or below**. The connection type can be changed by altering the position of the end connector.

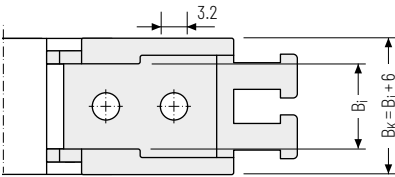
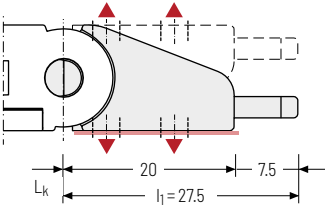

Single-part end connectors – plastic

The plastic end connectors can be connected **from above or below**. The connection type can be changed by altering the position of the end connector.

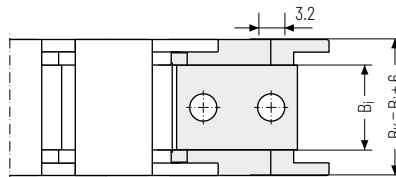
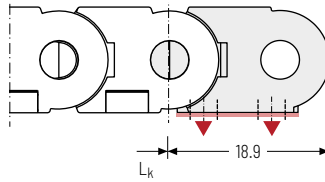

▲ Assembly options

Connection point
F – fixed point
M – driver

Connection type
A – threaded joint outside (standard)
I – threaded joint inside

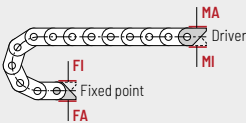

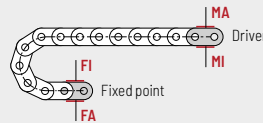

Connection point
F – fixed point
M – driver

Connection type
A – threaded joint outside (standard)
I – threaded joint inside



Order example

 End connector . F A
 End connector . M A
 End connector Connection point Connection type

 Depending on the design, the connection angles can be swivelled up to 12°.

Cable carrier
Cable carrier configuration
Configuration guidelines
Materials information
MONO series
QuickTrax® series
UNIFLEX Advanced series
TKP35 series
TKK series
EasyTrax® series

0180/.82/.84



Pitch
18 mm



Inner height
15 mm



Inner widths
10 – 40 mm



Bending radii
28 – 50 mm

Types



Type 0182 page 118

Closed frame (design 020)

- » Weight optimised, closed plastic frame with high torsional rigidity.
- » **Outside/inside:** not openable.



Type 0180 page 119

Frame with outside opening crossbars (design 030)

- » Weight optimised plastic frame with high torsional rigidity.
- » Openable at any position.
- » **Outside:** openable.



Type 0184 page 120

Frame with inside opening crossbars (design 040)

- » Weight optimised plastic frame with high torsional rigidity.
- » Openable at any position.
- » **Inside:** openable.

Optimised cable carrier geometry:

Easy to shorten and extend

Long service life through large bolt hole connection



High torsional rigidity through large link surface

Extensive unsupported length and high additional loads through optimised stroke system

Unsupported arrangement

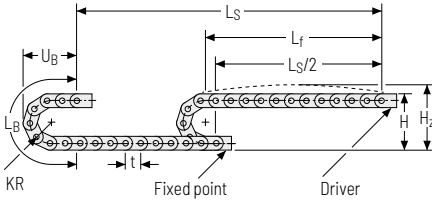





KR [mm]	H [mm]	H _z [mm]	L _B [mm]	U _B [mm]
28	74	89	124	55
37	92	107	153	64
50	118	133	194	77

Load diagram for unsupported length depending on the additional load.

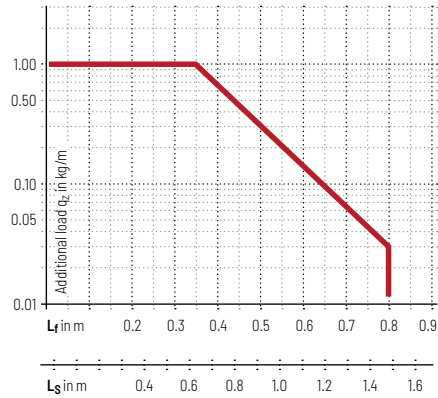
Sagging of the cable carrier is technically permitted for extended travel lengths, depending on the specific application.





Intrinsic cable carrier weight $q_k = 0.25 \text{ kg/m}$ with B_i 10 mm. For other inner widths, the maximum additional load changes.

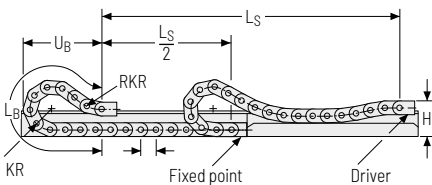

-  **Speed**
up to 10 m/s
-  **Acceleration**
up to 50 m/s^2
-  **Travel length**
up to 1.5 m
-  **Additional load**
up to 1.0 kg/m

Gliding arrangement



-  **Speed**
up to 3 m/s
-  **Acceleration**
up to 30 m/s^2
-  **Travel length**
up to 70 m
-  **Additional load**
up to 1.0 kg/m

 The gliding cable carrier must be guided in a channel. See p. 844.

Only designs 020 and 030 can be used for a gliding arrangement.

Cable carrier
Cable carrier configuration
Configuration guidelines
Materials information
MONO series
QuickTrax® series
UNIFLEX Advanced series
TKP35 series
TKK series
EasyTrax® series

Type 0182 – closed frame

- » Weight optimised, closed plastic frame with high torsional rigidity.
- » **Outside/inside:** not openable.



Stay arrangement on each chain link (**VS: fully-stayed**)



B_i 10 – 40 mm

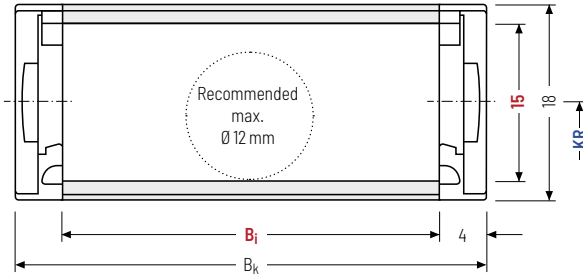

The maximum cable diameter strongly depends on the bending radius and the desired cable type. Please contact us.

Calculating the cable carrier length

Cable carrier length L_k

$$L_k \approx \frac{L_S}{2} + L_B$$

Cable carrier length L_k
rounded to pitch t

h_i [mm]	h_g [mm]	B_i [mm]				B_k [mm]	KR [mm]			q_k [kg/m]	
15	18	10	15	20	30	40	$B_i + 8$	28	37	50	0.123 – 0.186

Order example



MONO
Series

0182
Type

30
 B_i [mm]

37
 KR [mm]

720
 L_k [mm]

VS
Stay arrangement

Type 0180 - with outside opening crossbars

- » Weight optimised plastic frame with high torsional rigidity.
- » Openable at any position.
- » **Outside:** openable.

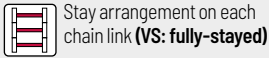

Stay arrangement on each chain link (**VS: fully-stayed**)



B_i 10 - 40 mm

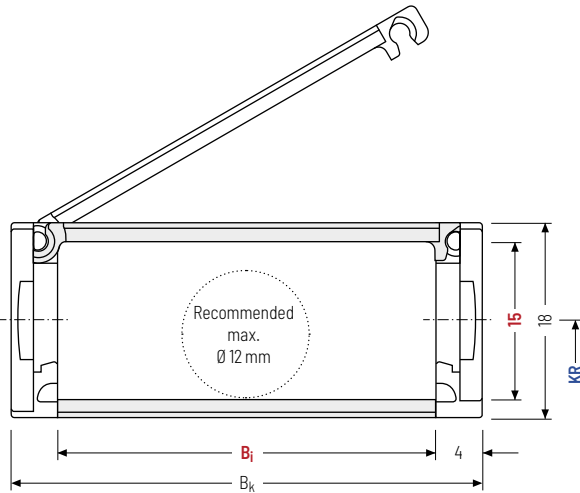

i The maximum cable diameter strongly depends on the bending radius and the desired cable type. Please contact us.

Calculating the cable carrier length

Cable carrier length L_k

$$L_k \approx \frac{L_S}{2} + L_B$$

Cable carrier length L_k rounded to pitch t

h_i [mm]	h_g [mm]	B_i [mm]			B_k [mm]	KR [mm]			q_k [kg/m]		
15	18	10	15	20	30	40	$B_i + 8$	28	37	50	0.169 - 0.252

Order example

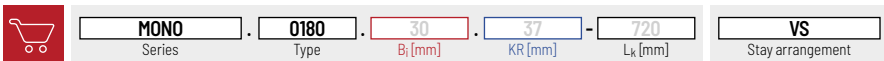

Type 0184 - with inside opening crossbars

- » Weight optimised plastic frame with high torsional rigidity.
- » Openable at any position.
- » **Inside:** openable.



Stay arrangement on each chain link (**VS: fully-stayed**)



B_i 10 - 40 mm

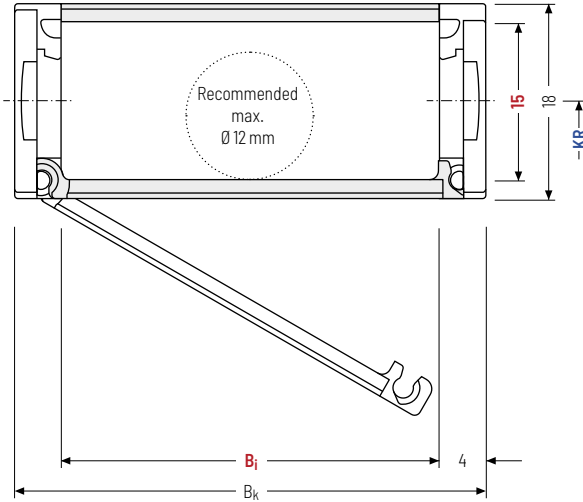

The maximum cable diameter strongly depends on the bending radius and the desired cable type. Please contact us.

Calculating the cable carrier length

Cable carrier length L_k

$$L_k \approx \frac{L_S}{2} + L_B$$

Cable carrier length L_k
rounded to pitch t

h_i [mm]	h_g [mm]	B_i [mm]				B_k [mm]	KR [mm]			q_k [kg/m]	
15	18	10	15	20	30	40	$B_i + 8$	28	37	50	0.133

Order example



MONO
Series

0184
Type

15
 B_i [mm]

37
 KR [mm]

720
 L_k [mm]

VS
Stay arrangement

Single-part end connectors – plastic
(with integrated strain relief)

The plastic end connectors can be connected **from above or below**. The connection type can be changed by altering the position of the end connector.

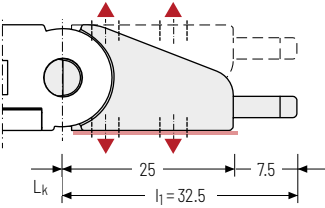

Bj: 10/15/20

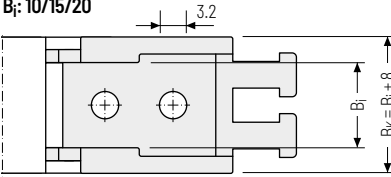

Bj: 30/40

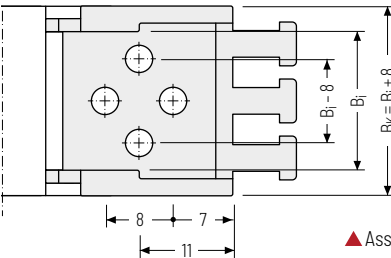

▲ Assembly options

Single-part end connectors – plastic

The plastic end connectors can be connected **from above or below**. The connection type can be changed by altering the position of the end connector.

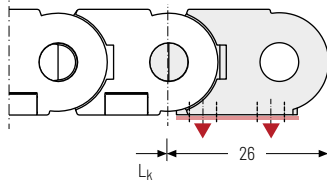

Bj: 10/15/20

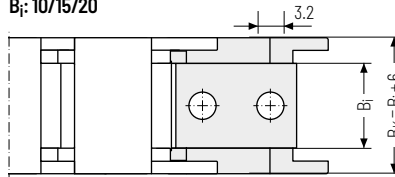

Bj: 30/40

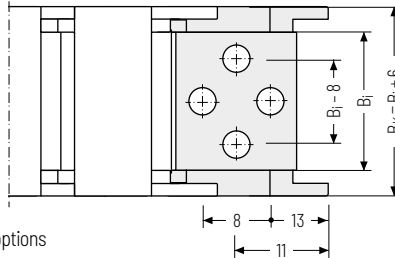

Connection point

- F** – fixed point
- M** – driver

Connection type

- A** – threaded joint outside (standard)
- I** – threaded joint inside

Connection point

- F** – fixed point
- M** – driver

Connection type

- A** – threaded joint outside (standard)
- I** – threaded joint inside

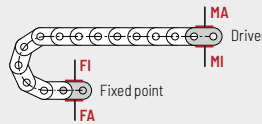
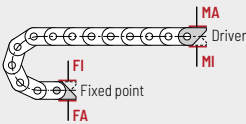

Order example

	End connector	.	F	A
	End connector	.	M	A
	End connector		Connection point	Connection type

Cable carrier
Cable carrier configuration
Configuration guidelines
Materials information
MONO series
QuickTrax® series
UNIFLEX Advanced series
TKP35 series
TKK series
EasyTrax® series

0202



Pitch
20 mm



Inner height
11 mm



Inner widths
6 - 20 mm



Bending radii
18 - 50 mm

Types



Type 0202..... page 124

Closed frame (design 020)

- » Weight optimised, closed plastic frame with high torsional rigidity.
- » **Outside/inside:** not openable.

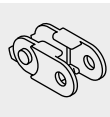

Fast cable laying – 0202 slotted version

The slotted variant of the MONO 0202 allows fast and easy pressing in of cables without opening the cable carrier. That saves time and therefore money. It is particularly suitable for cables with pre-assembled connectors. Please contact us!



Unsupported arrangement

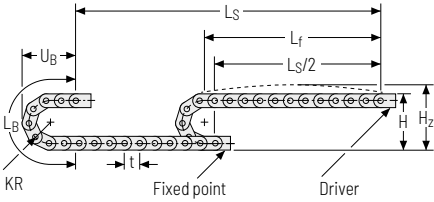

KR [mm]	H [mm]	H ₂ [mm]	L _B [mm]	U _B [mm]
18	51	61	97	45,5
28	71	81	128	55,5
38	91	101	160	65,5
50	115	125	198	77,5

Load diagram for unsupported length depending on the additional load.

Sagging of the cable carrier is technically permitted for extended travel lengths, depending on the specific application.

Intrinsic cable carrier weight $q_k = 0.18 \text{ kg/m}$ with $B_3 10 \text{ mm}$. For other inner widths, the maximum additional load changes.

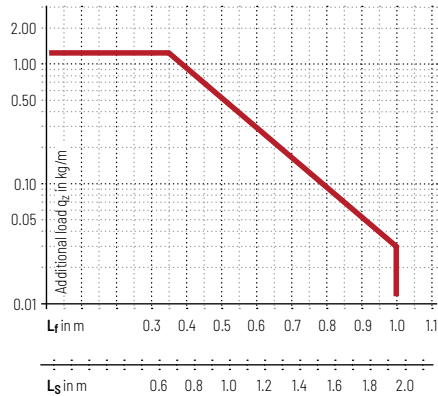

Speed
up to 10 m/s

Acceleration
up to 50 m/s^2

Travel length
up to 1.95 m

Additional load
up to 1.25 kg/m

Gliding arrangement

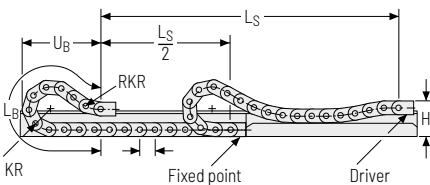

Speed
up to 3 m/s

Acceleration
up to 30 m/s^2

Travel length
up to 70 m

Additional load
up to 1.25 kg/m

The gliding cable carrier must be guided in a channel. See p. 844.

Cable carrier

Cable carrier configuration

Configuration guidelines

Materials information

MONO series

QuickTrax® series

UNIFLEX Advanced series

TKP35 series

TKK series

EasyTrax® series

Type 0202 - closed frame

- » Weight optimised, closed plastic frame with high torsional rigidity.
- » **Outside/inside:** not openable.



Stay arrangement on each chain link (**VS: fully-stayed**)



$B_i 6 - 20$ mm

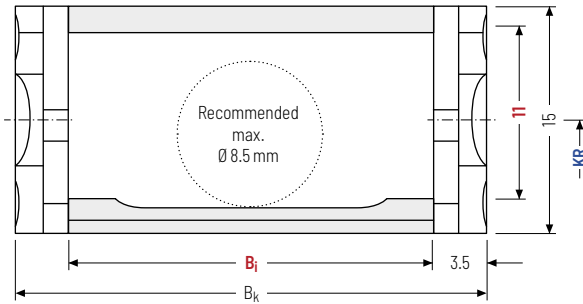

The maximum cable diameter strongly depends on the bending radius and the desired cable type. Please contact us.

Calculating the cable carrier length

Cable carrier length L_k

$$L_k \approx \frac{L_S}{2} + L_B$$

Cable carrier length L_k
rounded to pitch t

h_i [mm]	h_g [mm]	B_i [mm]			B_k [mm]	KR [mm]				q_k [kg/m]	
11	15	6	10	15	20	$B_i + 7$	18	28	38	50	0.14 - 0.17

Order example



MONO

Series

0202

Type

10

B_i [mm]

28

KR [mm]

460

L_k [mm]

VS

Stay arrangement

Single-part end connectors – plastic (with integrated strain relief)

The plastic end connectors can be **connected from above or below**. The connection type can be changed by altering the position of the end connector.

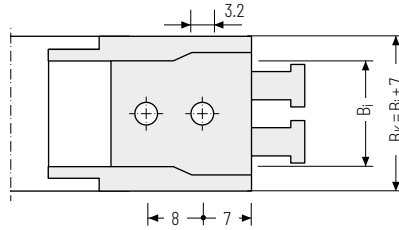
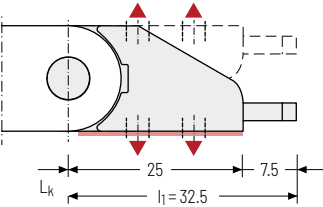

▲ Assembly options

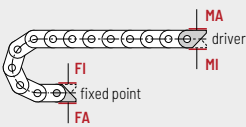

Connection point

- F - fixed point
- M - driver

Connection type

- A - threaded joint outside (standard)
- I - threaded joint inside

Order example

	End connector	.	F	A
	End connector	.	M	A
	End connector		Connection point	Connection type

Additional product information online



Installation instructions, etc.:
Additional info via your smartphone or check online at tsubaki-kabelschlepp.com/downloads



Configure your cable carrier here:
online-engineer.de

Cable carrier
Cable carrier configuration
Configuration guidelines
Materials information
MOND series
QuickTrax® series
UNIFLEX Advanced series
TKP35 series
TKK series
EasyTrax® series

QuickTrax[®] series

Compact and cost-effective
cable carriers in
two-component technology



Trademarks are legally protected for the TSUBAKI KABELSCHLEPP GmbH
as a national or international registration in the following countries:
tsubaki-kabelschlepp.com/trademarks

Subject to change without notice.

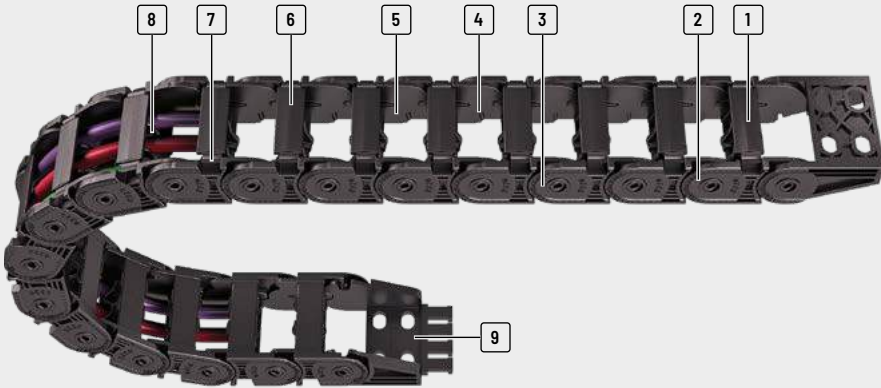

- 1 Sturdy 2-component design: hard chain body, flexible film hinge
- 2 Plastic chain links
- 3 Extensive unsupported length
- 4 Inside space is gentle on the cables – no interfering edges
- 5 Very quiet through integrated noise damping
- 6 Quick and easy to open
- 7 Inside/outside openable
- 8 Dividers and height separations for cable separation
- 9 Single-part end connectors with and without integratable strain relief

Features

- » Extremely fast and easy cable laying thanks to crossbar with film hinge
- » Each chain link consists of two different materials:
 - Hard chain body made of glass-fibre reinforced material
 - Crossbar with flexible film hinge made of elastic special plastic

- » Sturdy cable carrier design
- » High torsional rigidity
- » Very quiet through integrated noise damping
- » Extensive unsupported length



Easy to open...



...even without tools



High side stability



Reliable cable separation

Cable carrier

Cable carrier configuration

Configuration guidelines

Materials information

MONO series

QuickTrax® series

UNIFLEX Advanced series

TKP35 series

TKK series

EasyTrax® series

Cable carrier

Cable carrier design

Solid plastic cable carriers: chain links and end connectors made of plastic

Each chain link consists of two different materials:

- » Hard cable carrier body made of glass fiber-reinforced material
- » Flexible lamellae made of elastic plastic

Cable carrier configuration

Configuration guidelines

Materials information

MONO series

QuickTrax® series

UNIFLEX Advanced series

TKP35 series

TKK series

EasyTrax® series



The two-component technology of the QuickTrax®

The two-component technology of the **QuickTrax®** combines two seemingly incompatible features: **Stability and flexibility.**

Cable carriers need to be extremely sturdy, with extensive unsupported length. At the same time, cables need to be inserted easily for fast cable laying.

The **QuickTrax®** meets these requirements thanks to its innovative design and material combination of a hard cable carrier body made from glass fiber-reinforced material and crossbars with a film hinge made from rigid special plastic.

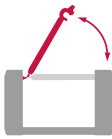

high flexibility



high stability

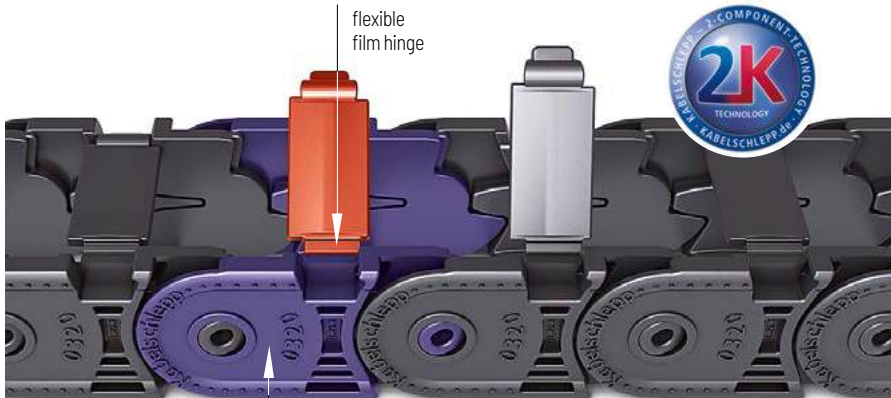

hard chain link of
fiber glass reinforced material

Comparison of dimensions

Manufacturer	h_i [mm]	h_G [mm]	t [mm]	Identical connection hole pattern
QuickTrax®	20.0	25.5	32.0	yes
Competitive product	17.5	23.0	30.5	yes

Comparison of bending moment

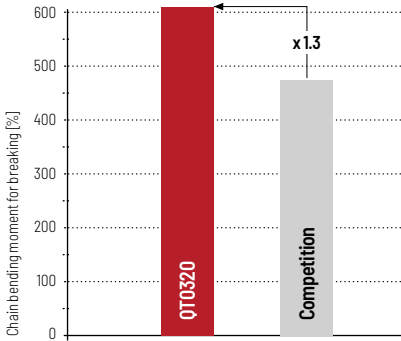

Comparison of bending strength

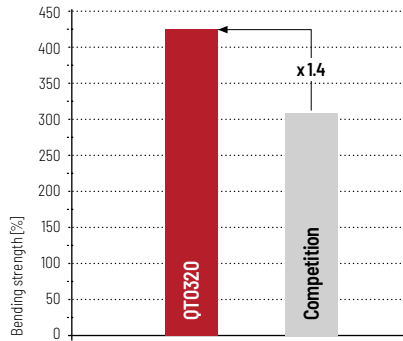

Load diagram

for unsupported length depending on additional load

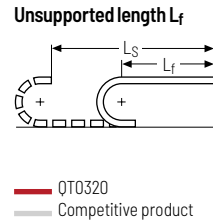
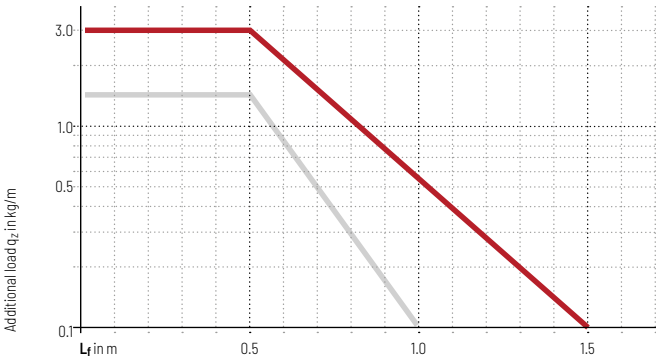

Advantages over competitive product

- » 20% longer unsupported length compared to competitive product
- » 33% greater additional load through use of fiber glass reinforced plastic
- » Greater inner height
- » Low noise operation due to internal damping system
- » High side stability through locking in the stroke system
- » Dividers can be used for cable separation

Cable carrier
Cable carrier configuration
Configuration guidelines
Materials information
MONO series
QuickTrax® series
UNIFLEX Advanced series
TKP35 series
TKK series
EasyTrax® series

Type	Opening variant	Stay variant	h_i [mm]	h_G [mm]	B_i [mm]	B_k [mm]	B_i - grid [mm]	t [mm]	KR [mm]	Additional load ≤ [kg/m]	Cable- d_{max} [mm]
QT0250											
		030	17.6	23	30 - 50	60	-	25	28 - 100	4	14
		040	17.6	23	30 - 50	60	-	25	28 - 100	4	14
QT0320											
		030	20	25,5	15 - 65	27 - 77	-	32	28 - 125	3	16
		040	20	25,5	15 - 65	27 - 77	-	32	28 - 125	3	16

MONO
seriesQuickTrax®
seriesUNIFLEX
Advanced
seriesTKP35
seriesTKK
seriesEasyTrax®
series

Unsupported arrangement			Gliding arrangement			Inner Distribution				Movement			Page
Travel length ≤ [m]	$v_{max} \leq [m/s]$	$a_{max} \leq [m/s^2]$	Travel length ≤ [m]	$v_{max} \leq [m/s]$	$a_{max} \leq [m/s^2]$	TS0	TS1	TS2	TS3	vertical hanging or standing	lying on the side	rotating arrangement	
1.6	10	50	60	3	30	•	•	-	-	•	•	•	134
1.6	10	50	-	-	-	•	•	-	-	•	•	•	135
2.9	10	50	80	2.5	25	•	•	-	-	•	•	•	140
2.9	10	50	-	-	-	•	•	-	-	•	•	•	141

Cable carrier
Cable carrier configuration
Configuration guidelines
Materials information
MONO series
QuickTrax® series
UNIFLEX Advanced series
TKP35 series
TKK series
EasyTrax® series

Subject to change without notice.

QT0250



Pitch
25 mm



Inner height
17,6 mm



Inner widths
30 – 50 mm



Bending radii
28 – 100 mm

Stay variants



Design 030 page 134

Frame with outside opening crossbars

- » Weight-optimised plastic frame with particularly high torsional rigidity.
- » Crossbar can be opened at any position on one side.
- » **Outside:** openable.



Design 040 page 135

Frame with inside opening crossbars

- » Weight-optimised plastic frame with particularly high torsional rigidity.
- » Crossbar can be opened at any position on one side.
- » **Inside:** openable.



UNIFLEX Advanced

For a non-opening cable carrier with 17,5 mm inner height we recommend the series UNIFLEX Advanced **UA1250** from page 150.

Unsupported arrangement

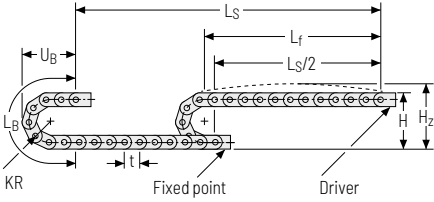

KR [mm]	H [mm]	H _z [mm]	L _B [mm]	U _B [mm]
28	79	104	138	65
38	99	124	169	75
45	113	138	191	82
60	143	168	238	97
75	173	198	286	112
100	223	248	364	137

Load diagram for unsupported length

depending on the additional load.

Intrinsic cable carrier weight $q_k = 0.36 \text{ kg/m}$ with $B_3 50 \text{ mm}$. For other inner widths, the maximum additional load changes.

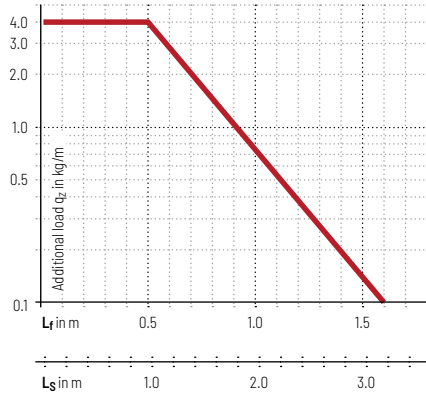

Speed
up to 10 m/s

Acceleration
up to 50 m/s^2

Travel length
up to 1.6 m

Additional load
up to 4 kg/m

Gliding arrangement

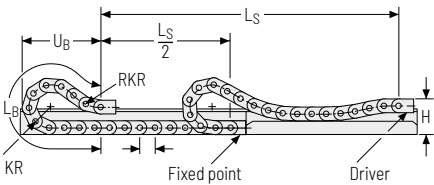

Speed
up to 3 m/s

Acceleration
up to 30 m/s^2

Travel length
up to 60 m

Additional load
up to 4 kg/m

The gliding cable carrier must be guided in a channel. See p. 844.

Only design 030 can be used for a gliding arrangement.

Cable carrier configuration	Configuration guidelines	Materials information	MONO series	QuickTrax® series	UNIFLEX Advanced series	TKP35 series	TKK series	EasyTrax® series
-----------------------------	--------------------------	-----------------------	-------------	-------------------	-------------------------	--------------	------------	------------------

Stay variant 030 – with outside opening crossbars

- » Weight-optimised plastic frame with particularly high torsional rigidity.
- » Crossbars can be opened at any position on one side
- » **Outside:** openable.



Stay arrangement on each chain link (**VS: fully-stayed**)



B_i : 30 – 50 mm

Cable carrier

Cable carrier configuration

Configuration guidelines

Materials information

MONO series

QuickTrax® series

UNIFLEX Advanced series

TKP35 series

TKK series

EasyTrax® series

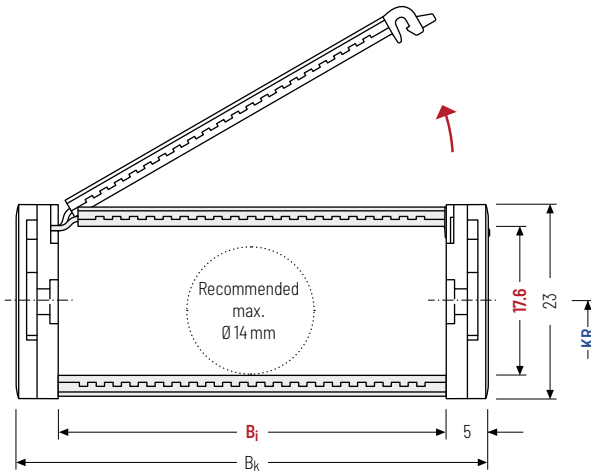

The maximum cable diameter strongly depends on the bending radius and the desired cable type. Please contact us.

Calculating the cable carrier length

Cable carrier length L_k

$$L_k \approx \frac{L_S}{2} + L_B$$

Cable carrier length L_k rounded to pitch t

h_i [mm]	h_g [mm]	B_i [mm]	B_k [mm]	KR [mm]	q_k [kg/m]
17.6	23	30 50	$B_i + 10$	28 38 45 60 75 100	0.32 – 0.36

Order example



QT0250

Type

030

Stay variant

50

 B_i [mm]

75

 KR [mm]

1.100

 L_k [mm]

VS

Stay arrangement

Stay variant 040 – with inside opening crossbars

- » Weight-optimised plastic frame with particularly high torsional rigidity.
- » Crossbars can be opened at any position on one side
- » **Inside:** openable.

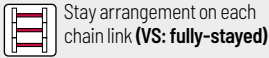

Stay arrangement on each chain link (VS: fully-stayed)



B_i 30 – 50 mm

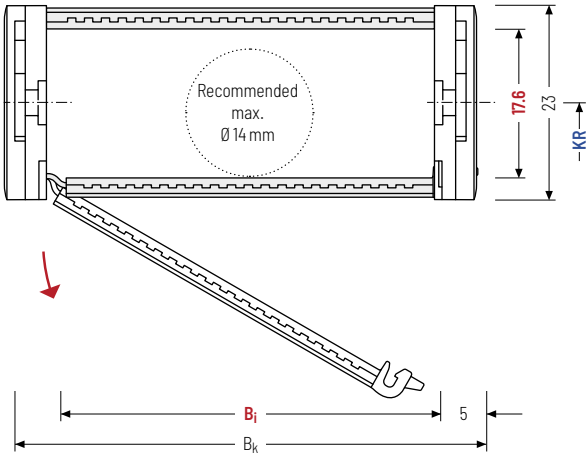

i The maximum cable diameter strongly depends on the bending radius and the desired cable type. Please contact us.

Calculating the cable carrier length

Cable carrier length L_k

$$L_k \approx \frac{L_S}{2} + L_B$$

Cable carrier length L_k rounded to pitch t

h_i [mm]	h_g [mm]	B_i [mm]	B_k [mm]	KR [mm]					q_k [kg/m]	
17.6	23	30 50	$B_i + 10$	28	38	45	60	75	100	0.32 – 0.36

Order example

QT0250 .
 040 .
 50 .
 75 .
 1.100 .
 VS

Type Stay variant B_i [mm] KR [mm] L_k [mm] Stay arrangement

Cable carrier
Cable carrier configuration
Configuration guidelines
Materials information
MONO series
QuickTrax® series
UNIFLEX Advanced series
TKP35 series
TKK series
EasyTrax® series

Divider systems

The divider system is mounted on every 2nd chain link as a standard.

As a standard, dividers or the complete divider system (dividers with height separations) are movable in the cross section (**version A**).

For applications with lateral accelerations and applications with the cable carrier rotated by 90°, the dividers can easily be fixed on the stay through rotation.

The arresting cams snap into the catch profiles in the covers (**version B**).

Divider system TSO without height separation

Vers.	a_T min [mm]	a_x min [mm]	a_c min [mm]	a_x grid [mm]	n_T min
A	3	6	4	-	-
B	3	6	4	2	-

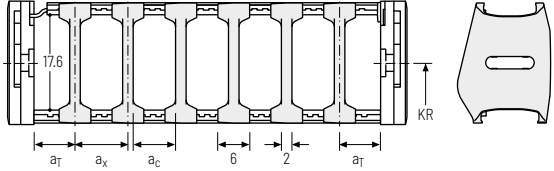

Divider system TS1 with continuous height separation

Vers.	a_T min [mm]	a_x min [mm]	a_c min [mm]	a_x grid [mm]	n_T min
A	3	6	4	-	2
B	3	6	4	2	2

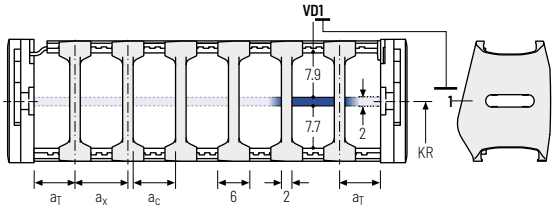

Order example



· · -
 :

Divider system Version n_T Height separation

Please state the designation of the divider system (TS0, TS1,...), the version, and the number of dividers per cross section [n_T].

When using divider systems with height separation (TS1), please additionally state the position (e.g. VDI) viewed from the left driver belt. You are welcome to add a sketch to your order.

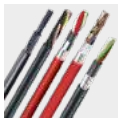

TRAXLINE® cables for cable carriers

Hi-flex electric cables which were specially developed, optimised and tested for use in cable carriers can be found at tsubaki-kabelschlepp.com/traxline.

Single-part end connectors – plastic (with integrated strain relief)

The plastic end connectors can be connected from above or below. The connection type can be changed by altering the position of the end connector.

Driver

Fixed point

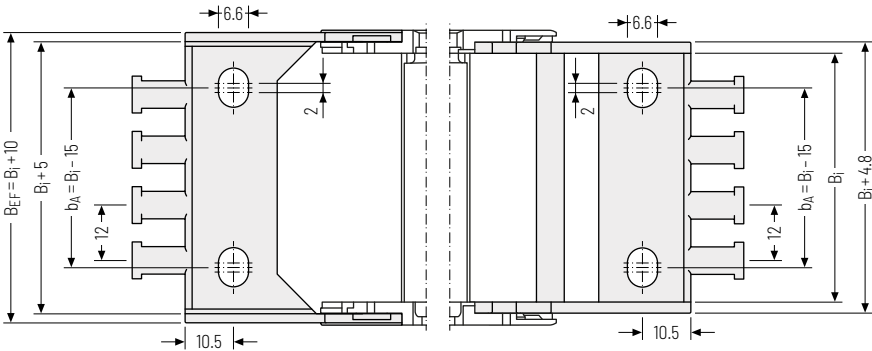
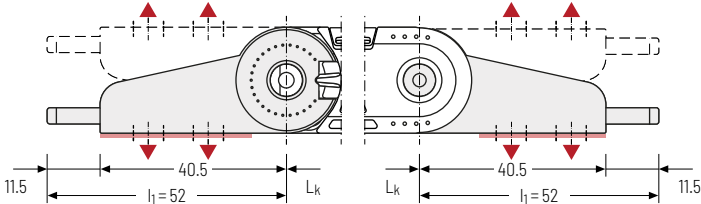

▲ Assembly options

B_i [mm]	B_{EF} [mm]	n_z
30	40	2
50	60	4

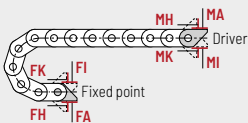

Connection point

- F - fixed point
- M - driver

Connection type

- A - threaded joint outside (standard)
- I - threaded joint inside
- H - threaded joint, rotated 90° to the outside
- K - threaded joint, rotated 90° to the inside

Order example



Cable carrier
Cable carrier configuration
Configuration guidelines
Materials information
MONO series
QuickTrax® series
UNIFLEX Advanced series
TKP35 series
TKK series
EasyTrax® series

QT0320



Pitch
32 mm



Inner height
20 mm



Inner widths
15 - 65 mm



Bending radii
28 - 125 mm

Stay variants



Design 030 page 140

Frame with outside opening crossbars

- » Weight-optimised plastic frame with particularly high torsional rigidity.
- » Crossbar can be opened at any position on one side.
- » **Outside:** openable.



Design 040 page 141

Frame with inside opening crossbars

- » Weight-optimised plastic frame with particularly high torsional rigidity.
- » Crossbar can be opened at any position on one side.
- » **Inside:** openable.

Unsupported arrangement

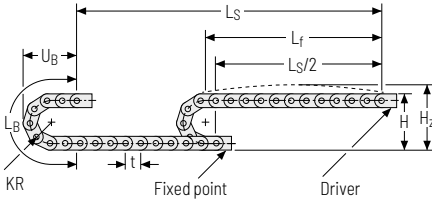

KR [mm]	H [mm]	H ₂ [mm]	L _B [mm]	U _B [mm]
28	81.5	101.5	152	73
38	101.5	121.5	184	83
48	121.5	141.5	215	93
75	175.5	195.5	300	120
100	225.5	245.5	379	145
125	275.5	295.5	457	170

Load diagram for unsupported length

depending on the additional load.

Intrinsic cable carrier weight $q_k = 0.40 \text{ kg/m}$ with $B_j 38 \text{ mm}$. For other inner widths, the maximum additional load changes.

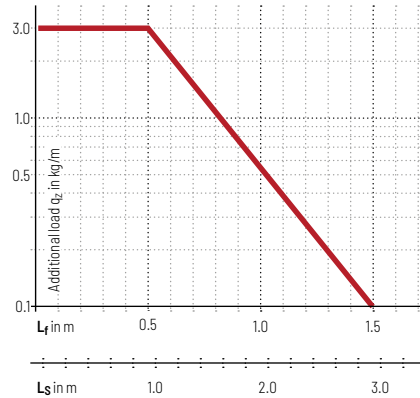

Speed
up to 10 m/s

Acceleration
up to 50 m/s^2

Travel length
up to 2.9 m

Additional load
up to 3 kg/m

Gliding arrangement

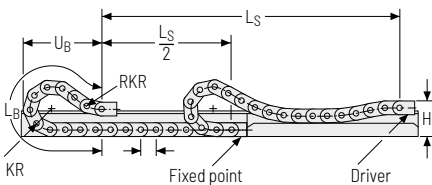

Speed
up to 2.5 m/s

Acceleration
up to 25 m/s^2

Travel length
up to 80 m

Additional load
up to 3 kg/m

The gliding cable carrier must be guided in a channel. See p. 844.

Only design 030 can be used for a gliding arrangement.

Cable carrier configuration
Cable carrier configuration
Configuration guidelines
Materials information
MONO series
QuickTrax® series
UNIFLEX Advanced series
TKP35 series
TKK series
EasyTrax® series

Stay variant 030 – with outside opening crossbars

- » Weight-optimised plastic frame with particularly high torsional rigidity.
- » Crossbars can be opened at any position on one side
- » **Outside:** openable.



Stay arrangement on each chain link (**VS: fully-stayed**)



B_i 15 – 65 mm

Cable carrier

Cable carrier configuration

Configuration guidelines

Materials information

MONO series

QuickTrax® series

UNIFLEX Advanced series

TKP35 series

TKK series

EasyTrax® series

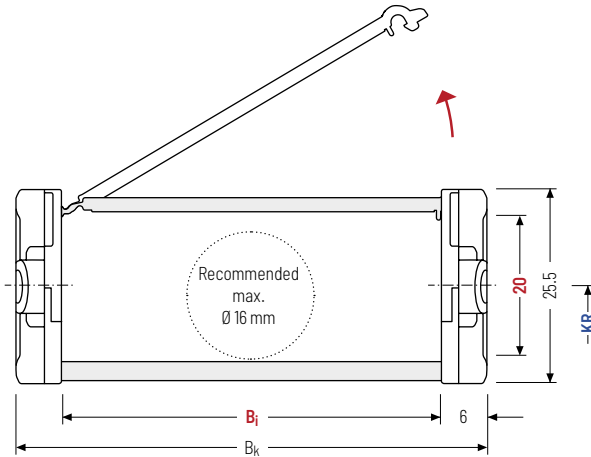

The maximum cable diameter strongly depends on the bending radius and the desired cable type. Please contact us.

Calculating the cable carrier length

Cable carrier length L_k

$$L_k \approx \frac{L_S}{2} + L_B$$

Cable carrier length L_k rounded to pitch t

h_i [mm]	h_G [mm]	B_i [mm]				B_k [mm]				KR [mm]			q_k [kg/m]	
20	25.5	15	25	38	50	65	$B_i + 12$	28	38	48	75	100	125	0.35 – 0.45

Order example



QT0320

Type

030

Stay variant

50

 B_i [mm]

100

 KR [mm]

1,280

 L_k [mm]

VS

Stay arrangement

Stay variant 040 – with inside opening crossbars

- » Weight-optimised plastic frame with particularly high torsional rigidity.
- » Crossbars can be opened at any position on one side
- » **Inside:** openable.

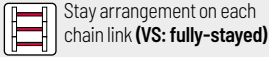

Stay arrangement on each chain link (VS: fully-stayed)



B_i 15 – 65 mm

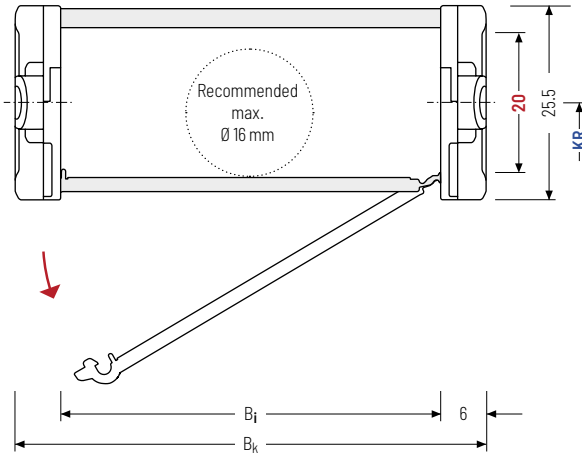

The maximum cable diameter strongly depends on the bending radius and the desired cable type. Please contact us.

Calculating the cable carrier length

Cable carrier length L_k

$$L_k \approx \frac{L_S}{2} + L_B$$

Cable carrier length L_k
rounded to pitch t

h_i [mm]	h_g [mm]	B_i [mm]		B_k [mm]	KR [mm]			q_k [kg/m]						
20	25.5	15	25	38	50	65	$B_i + 12$	28	38	48	75	100	125	0.35 – 0.45

Order example

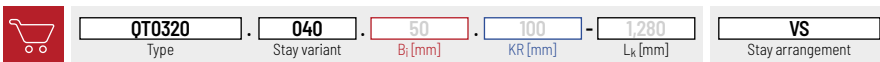

Divider systems

The divider system is mounted on each crossbar as a standard - on every 2nd chain link for stay mounting (HS).

As a standard, dividers or the complete divider system (dividers with height separations) are movable in the cross section (**version A**).

Divider system TSO without height separation

Vers.	a_T min [mm]	a_x min [mm]	a_c min [mm]	n_T min
A	4	8	6	-

The dividers can be moved in the cross section.

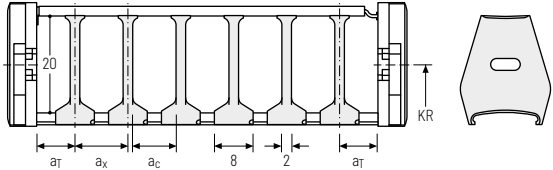

Divider system TS1 with continuous height separation

Vers.	a_T min [mm]	a_x min [mm]	a_c min [mm]	n_T min
A	4	8	6	2

The dividers can be moved in the cross section.

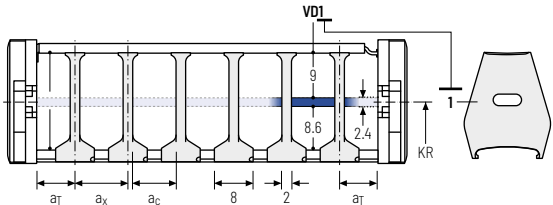

Order example

	<input type="text" value="TS1"/>	·	<input type="text" value="A"/>	·	<input type="text" value="3"/>	-	<input type="text" value="V D0"/>
							⋮
							<input type="text" value="V D1"/>
	Divider system		Version		n_T		Height separation

Please state the designation of the divider system (TS0, TS1,...), the version, and the number of dividers per cross section [n_T].

When using divider systems with height separation (TS1), please additionally state the position (e.g. VD1) viewed from the left driver belt. You are welcome to add a sketch to your order.

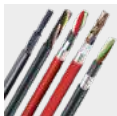

TRAXLINE® cables for cable carriers

Hi-flex electric cables which were specially developed, optimised and tested for use in cable carriers can be found at tsubaki-kabelschlepp.com/traxline.

Single-part end connectors – plastic (with integrated strain relief)

The plastic end connectors can be connected from above or below. The connection type can be changed by altering the position of the end connector.

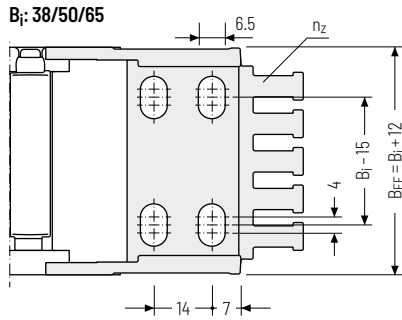
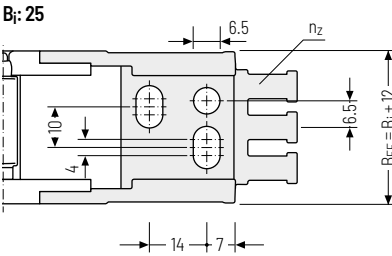
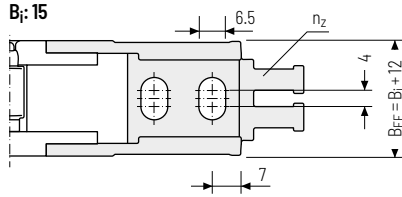
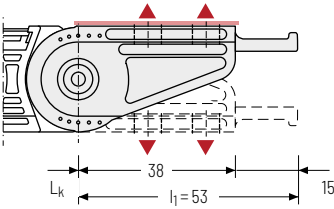

▲ Assembly options

The end connectors can not be swivelled.

B_i [mm]	B_{EF} [mm]	n_z
15	27	2
25	37	3
38	50	4
50	62	5
65	77	6

The end connectors are also available as an option **without** integrated strain relief. Please state when ordering.

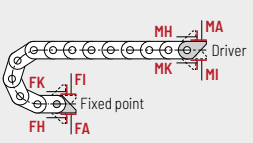

Connection point
F - fixed point
M - driver

Connection type
A - threaded joint outside (standard)
I - threaded joint inside
H - threaded joint, rotated 90° to the outside
K - threaded joint, rotated 90° to the inside

Order example

End connector . F A
 End connector . M A
 End connector Connection point Connection type

Cable carrier
Cable carrier configuration
Configuration guidelines
Materials information
MONO series
QuickTrax® series
UNIFLEX Advanced series
TKP35 series
TKK series
EasyTrax® series

UNIFLEX *Advanced* series

Light, quiet all-rounder with a
wide range of applications*



* Some features can be different
for certain types for design reasons.

Trademarks are legally protected for the TSUBAKI KABELSCHLEPP GmbH as
a national or international registration in the following countries:
tsubaki-kabelschlepp.com/trademarks

Subject to change without notice.

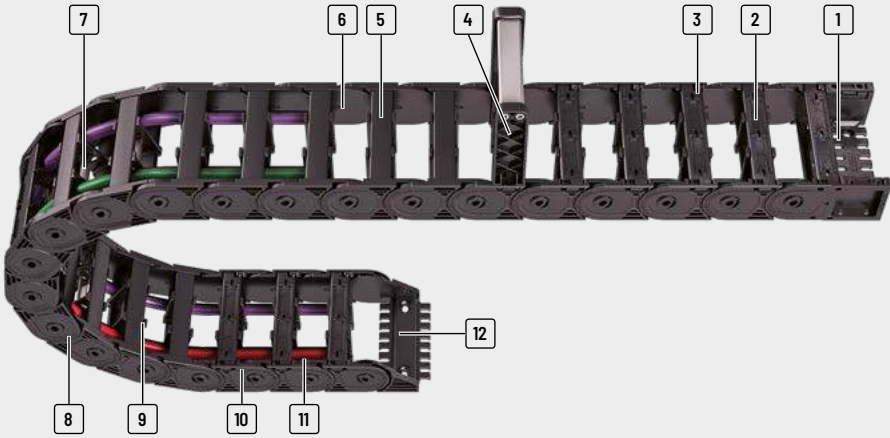

- 1 Universal mounting bracket (UMB) with integratable strain relief comb
- 2 Designs with inside or outside opening stays
- 3 Extremely fast and easy to open due to ball joint mechanism
- 4 Top-mounted frame stay
- 5 Single-part links (type 020)
- 6 Favourable ratio of inner to outer width
- 7 Many separation options for the cables
- 8 Robust double-stroke system for long unsupported lengths
- 9 Easy divider fixing
- 10 Very quiet through integrated noise damping
- 11 Lateral wear surfaces
- 12 Single-part end connectors with integratable strain relief comb

Features

- » Extensive unsupported lengths
- » High torsional rigidity
- » Good ratio of inner to outer width
- » Numerous custom material types for custom applications available
- » Easy assembly and fast cable laying
- » Assembly tools available
- » Stays with ball joint opening on both sides
- » Many possibilities for internal subdivision
- » Wear surfaces for gliding applications with extended travel lengths

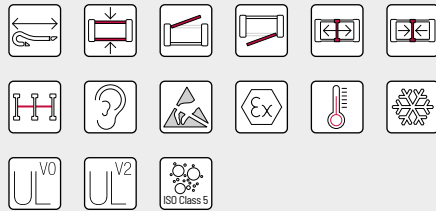

Fixable dividers for arrangements rotated by 90° and applications with high lateral accelerations – no additional spacers required

Lateral wear surfaces – for long service life for applications where the carrier is rotated through 90°

Simple fixing of strain relief comb or C-Rail in the connector

Cable carrier

Cable carrier configuration

Configuration guidelines

Materials information

MONO series

QuickTrax® series

UNIFLEX
Advanced series

TKP35 series

TKK series

EasyTrax® series

	Type	Opening variant	Stay variant	h_i [mm]	h_G [mm]	B_i [mm]	B_k [mm]	B_i - grid [mm]	t [mm]	KR [mm]	Additional load ≤ [kg/m]	Cable- d_{max} [mm]
Cable carrier												
Cable carrier configuration												
Configuration guidelines												
Materials information												
MONO series												
QuickTrax® series												
UNIFLEX Advanced series												
TKP35 series												
TKK series												
EasyTrax® series												
UA1250												
		020	17.5	23	30 - 50	60	-	25	28 - 100	4	14	
UA1320												
		020	20	25.5	15 - 65	27 - 77	-	32	28 - 125	3.0	16	
UA1455												
		020	26	36	25 - 130	41 - 146	-	45.5	52 - 200	6	20.5	
		030	26	36	25 - 130	41 - 146	-	45.5	52 - 200	6	20.5	
		040	26	36	25 - 130	41 - 146	-	45.5	52 - 200	6	20.5	
UA1555												
		020	38	50	50 - 150	68 - 168	-	55.5	63 - 200	10	30	
		030	38	50	50 - 150	68 - 168	-	55.5	63 - 200	10	30	
		040	38	50	50 - 150	68 - 168	-	55.5	63 - 200	10	30	
UA1665												
		020	44	60	50 - 250	72 - 272	-	66.5	75 - 300	15	35	
		030	44	60	50 - 250	72 - 272	-	66.5	75 - 300	15	35	
		040	44	60	50 - 250	72 - 272	-	66.5	75 - 300	15	35	
		RMA	44 (114-189)	60 (170-245)	125 - 200	147 - 222	1	66.5	75 - 300	15	35/151	

Unsupported arrangement			Gliding arrangement			Inner Distribution				Movement			Page
Travel length ≤ [m]	$v_{max} \leq [m/s]$	$a_{max} \leq [m/s^2]$	Travel length ≤ [m]	$v_{max} \leq [m/s]$	$a_{max} \leq [m/s^2]$	TS0	TS1	TS2	TS3	vertical hanging or standing	lying on the side	rotating arrangement	
16	10	50	60	3	30	•	-	-	-	•	•	•	152
2.9	10	50	80	2.5	25	•	-	-	-	•	•	•	158
4.8	10	50	120	2.5	20	•	-	-	•	•	•	•	164
4.8	10	50	120	2.5	20	•	•	-	•	•	•	•	165
4.8	10	50	-	-	-	•	•	-	•	•	•	•	166
6.3	9	45	125	3	20	•	-	-	•	•	•	•	174
6.3	9	45	125	3	20	•	•	-	•	•	•	•	175
6.3	9	45	-	-	-	•	•	-	•	•	•	•	176
7	8	40	150	3	15	•	-	-	•	•	•	•	184
7	8	40	150	3	15	•	•	-	•	•	•	•	185
7	8	40	-	-	-	•	•	-	•	•	•	•	186
7	8	40	150	3	15	•	•	-	•	•	•	-	188

Subject to change without notice.

Cable carrier

Cable carrier configuration

Configuration guidelines

Materials information

MONO series





QuickTrax® series

UNIFLEX Advanced series

TKP35 series

TKK series

EasyTrax® series

Type	Opening variant	Stay variant	h_i	h_G	B_i	B_k	B_i - grid	t	KR	Additional load \leq [kg/m]	Cable- d_{max} [mm]
			[mm]	[mm]	[mm]	[mm]	[mm]	[mm]	[mm]		
UA1775											
		020	56	77	100 - 400	126 - 476	-	77.5	90 - 340	25	44
		030	56	77	100 - 400	126 - 476	-	77.5	90 - 340	25	44
		040	56	77	100 - 400	126 - 476	-	77.5	90 - 340	25	44
UA1995											
		020	80	110	85 - 250	115 - 280	-	99.5	150 - 500	50	64
		030	80	110	85 - 250	115 - 280	-	99.5	150 - 500	50	64
		040	80	110	85 - 250	115 - 280	-	99.5	150 - 500	50	64
		070	80	110	85 - 250	115 - 280	-	99.5	150 - 500	50	64

Cable carrier

Cable carrier
configurationConfiguration
guidelinesMaterials
informationMONO
seriesQuickTrax®
seriesUNIFLEX
Advanced
seriesTKP35
seriesTKK
seriesEasyTrax®
series

Unsupported arrangement			Gliding arrangement			Inner Distribution				Movement			Page
Travel length ≤ [m]	$v_{max} \leq [m/s]$	$a_{max} \leq [m/s^2]$	Travel length ≤ [m]	$v_{max} \leq [m/s]$	$a_{max} \leq [m/s^2]$	TS0	TS1	TS2	TS3	vertical hanging or standing	lying on the side	rotating arrangement	
7.8	10	35	200	3	8	•	-	-	•	•	•	•	196
7.8	10	35	200	3	8	•	•	-	•	•	•	•	197
7.8	10	35	200	3	8	•	•	-	•	•	•	•	198
9	10	25	200	8	20	•	-	-	•	•	•	•	204
9	10	25	200	8	20	•	•	-	•	•	•	•	205
9	10	25	200	8	20	•	•	-	•	•	•	•	206
9	10	25	200	8	200	•	•	-	•	•	•	•	207

Cable carrier

Cable carrier configuration

Configuration guidelines

Materials information

MONO series

QuickTrax® series

UNIFLEX Advanced series

TKP35 series

TKK series

EasyTrax® series

UA1250



Pitch
25 mm



Inner height
17,5 mm



Inner widths
30 – 50 mm



Bending radii
28 – 100 mm

Stay variants



Design 020 page 158

Closed frame

- » Weight-optimised, closed plastic frame with particularly high torsional rigidity.
- » **Outside/inside:** not openable.



QuickTrax® | EasyTrax®

For an openable cable carrier with 16.5 – 17.6 mm inner height we recommend the series QuickTrax® 0250 or EasyTrax® 0250 **QT0250 from page 132** and **ET0250 from page 244**.

Unsupported arrangement

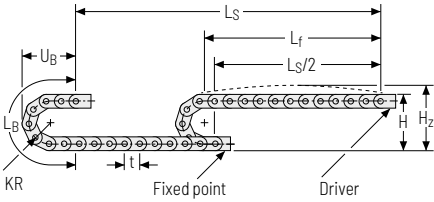

KR [mm]	H [mm]	H ₂ [mm]	L _B [mm]	U _B [mm]
28	79	104	138	65
38	99	124	169	75
45	113	138	191	82
60	143	168	238	97
75	173	198	286	112
100	223	248	364	137

Load diagram for unsupported length depending on the additional load.

Sagging of the cable carrier is technically permitted for extended travel lengths, depending on the specific application.

Intrinsic cable carrier weight $q_k = 0.36 \text{ kg/m}$ with $B_i 50 \text{ mm}$. For other inner widths, the maximum additional load changes.

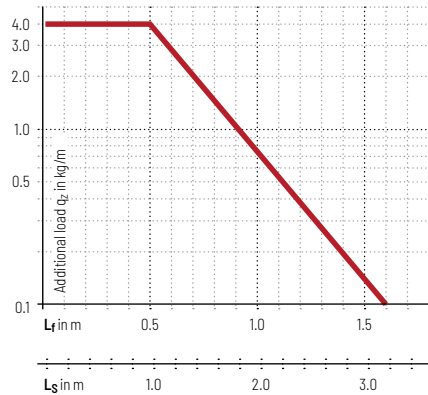

Speed
up to 10 m/s

Acceleration
up to 50 m/s^2

Travel length
up to 1.6 m

Additional load
up to 4 kg/m

Gliding arrangement

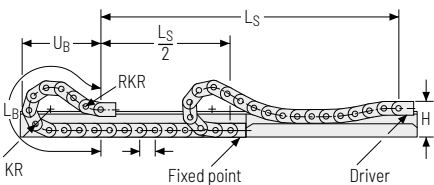

Speed
up to 3 m/s

Acceleration
up to 30 m/s^2

Travel length
up to 60 m

Additional load
up to 4 kg/m

The gliding cable carrier must be guided in a channel. See p. 844.

Cable carrier
Cable carrier configuration
Configuration guidelines
Materials information
MONO series
QuickTrax® series
UNIFLEX Advanced series
TKP35 series
TKK series
EasyTrax® series

Stay variant 020 – closed frame

- » Weight-optimised, closed plastic frame with particularly high torsional rigidity.
- » **Outside/inside:** not openable.



Stay arrangement on each chain link (**VS: fully-stayed**)



B_i : 30 – 50 mm

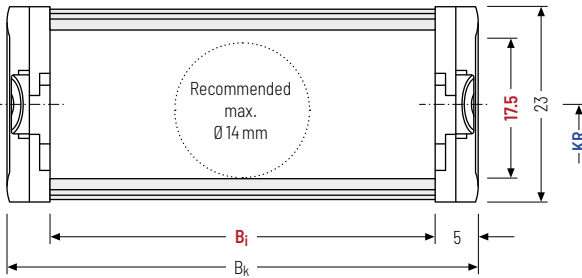

The maximum cable diameter strongly depends on the bending radius and the desired cable type. Please contact us.

Calculating the cable carrier length

Cable carrier length L_k

$$L_k \approx \frac{L_S}{2} + L_B$$

Cable carrier length L_k
rounded to pitch t

h_i [mm]	h_g [mm]	B_i [mm]	B_k [mm]	KR [mm]				q_k [kg/m]		
17.5	23	30 50	$B_i + 10$	28	38	45	60	75	100	0.32 – 0.36

Order example



UA1250

Type

020

Stay variant

50

B_i [mm]

75

KR [mm]

1100

L_k [mm]

VS

Stay arrangement

Divider systems

The divider system is mounted on every 2nd chain link as a standard.

As a standard, dividers or the complete divider system (dividers with height separations) are movable in the cross section (**version A**).

For applications with lateral accelerations and applications with the cable carrier rotated by 90°, the dividers can easily be fixed on the stay through rotation.

The arresting cams snap into the catch profiles in the covers (**version B**).

Divider system TSO without height separation

Vers.	a _T min [mm]	a _x min [mm]	a _c min [mm]	a _x grid [mm]	n _T min
A	3	6	4	-	-
B	3	6	4	2	-

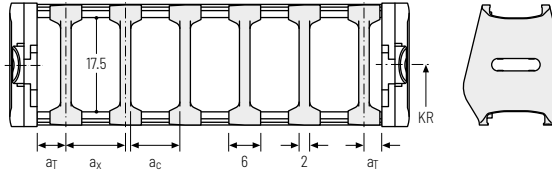

Order example



. .
 Divider system Version n_T

Please state the designation of the divider system (TSO), the version, and the number of dividers per cross section [n_T]. You are welcome to add a sketch to your order.

Cable carrier

Cable carrier configuration

Configuration guidelines

Materials information

MONO series

QuickTrax® series

UNIFLEX Advanced series

TKP35 series

TKK series

EasyTrax® series

Additional product information online



Installation instructions, etc.:
Additional info via your smartphone or check online at tsubaki-kabelschlepp.com/downloads



Configure your cable carrier here:
online-engineer.de

Single-part end connectors – plastic (with integrated strain relief)

The plastic end connectors can be connected **from above or below**. The connection type can be changed by altering the position of the end connector.

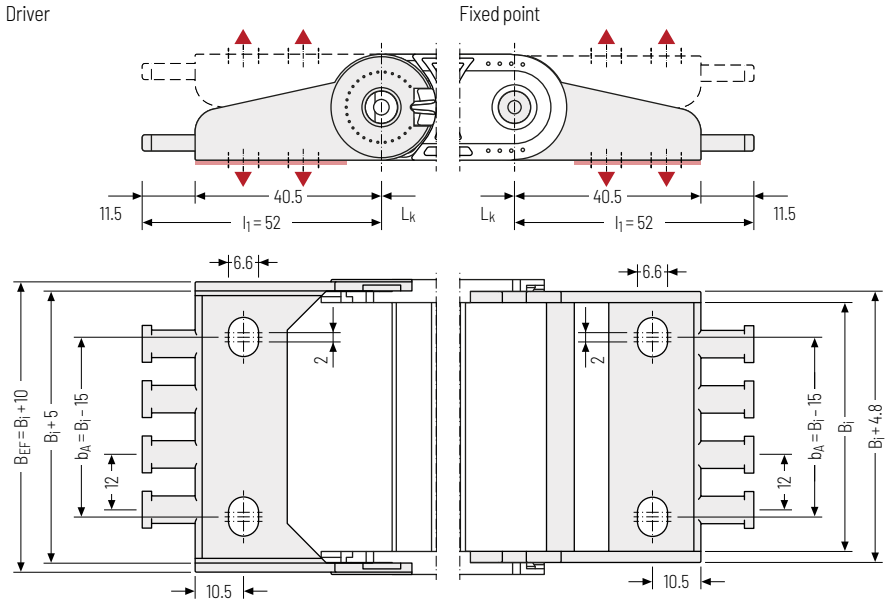

▲ Assembly options

B_i [mm]	B_{EF} [mm]	n_z
30	40	2
50	60	4

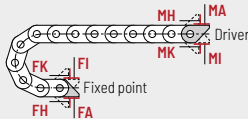

Connection point

- F – fixed point
- M – driver

Connection type

- A – threaded joint outside (standard)
- I – threaded joint inside
- H – threaded joint, rotated 90° to the outside
- K – threaded joint, rotated 90° to the inside

Order example



End connector	F	A
End connector	M	A
End connector	Connection point	Connection type



UNIFLEX
Advanced series

EasyTrax®
series

TKK
series

TKP35
series

QuickTrax®
series

MONO
series

Materials
information

Configuration
guidelines

Cable carrier
configuration

Cable carrier

UA1320



Pitch
32 mm



Inner height
20 mm



Inner widths
15 – 65 mm



Bending radii
28 – 125 mm

Stay variants



Design 020 page 158

Closed frame

- » Weight-optimised, closed plastic frame with particularly high torsional rigidity.
- » **Outside/inside:** not openable.

Cable carrier

Cable carrier configuration

Configuration guidelines

Materials information

MONO series

QuickTrax® series

UNIFLEX Advanced series

TKP35 series

TKK series

EasyTrax® series



QuickTrax® | EasyTrax®

For an openable cable carrier with 18 – 20 mm inner height we recommend the series QuickTrax® 0320 or EasyTrax® 0320 **QT0320 from page 138** and **ET0320 from page 250**.

Unsupported arrangement

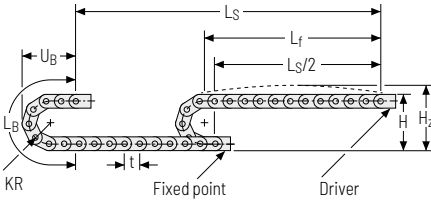





KR [mm]	H [mm]	H ₂ [mm]	L _B [mm]	U _B [mm]
28	81.5	98.5	152	73
38	101.5	118.5	184	83
48	121.5	138.5	215	93
75	175.5	192.5	300	120
100	225.5	242.5	379	145
125	275.5	292.5	457	170

Load diagram for unsupported length depending on the additional load.

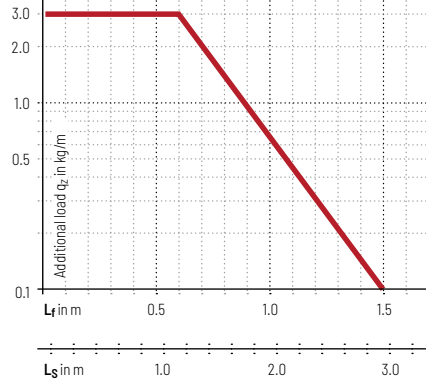
Sagging of the cable carrier is technically permitted for extended travel lengths, depending on the specific application.





Intrinsic cable carrier weight $q_k = 0.40 \text{ kg/m}$ with $B_i 50 \text{ mm}$. For other inner widths, the maximum additional load changes.

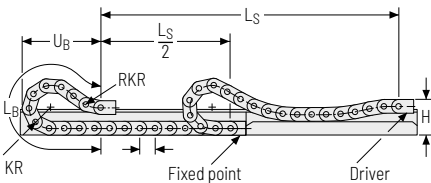

-  **Speed**
up to 10 m/s
-  **Acceleration**
up to 50 m/s^2
-  **Travel length**
up to 2.9 m
-  **Additional load**
up to 3 kg/m

Gliding arrangement



-  **Speed**
up to 2.5 m/s
-  **Acceleration**
up to 25 m/s^2
-  **Travel length**
up to 80 m
-  **Additional load**
up to 3 kg/m

 The gliding cable carrier must be guided in a channel. See p. 844.

Cable carrier
Cable carrier configuration
Configuration guidelines
Materials information
MONO series
QuickTrax® series
UNIFLEX Advanced series
TKP35 series
TKK series
EasyTrax® series

Stay variant 020 – closed frame

- » Weight-optimised, closed plastic frame with particularly high torsional rigidity.
- » **Outside/inside:** not openable.



Stay arrangement on each chain link (**VS: fully-stayed**)



B_i 15 – 65 mm

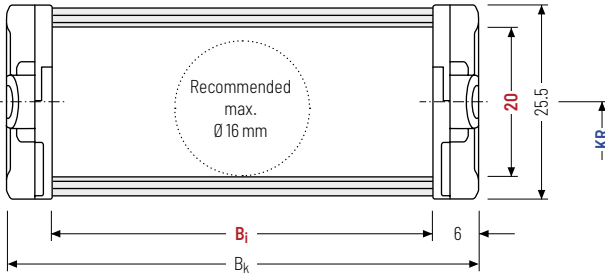

The maximum cable diameter strongly depends on the bending radius and the desired cable type. Please contact us.

Calculating the cable carrier length

Cable carrier length L_k

$$L_k \approx \frac{L_S}{2} + L_B$$

Cable carrier length L_k rounded to pitch t

h_i [mm]	h_g [mm]	B_i [mm]				B_k [mm]		KR [mm]				q_k [kg/m]		
20	25.5	15	25	38	50	65	$B_i + 12$	28	38	48	75	100	125	0.36 – 0.48

Order example



UA1320

Type

020

Stay variant

50

B_i [mm]

100

KR [mm]

960

L_k [mm]

VS

Stay arrangement

Divider systems

The divider system is mounted on every 2nd chain link as a standard.

As a standard, dividers or the complete divider system (dividers with height separations) are movable in the cross section (**version A**).

Divider system TSO without height separation

Vers.	a _T min [mm]	a _x min [mm]	a _c min [mm]	n _T min
A	4	8	6	-

The dividers can be moved in the cross section.

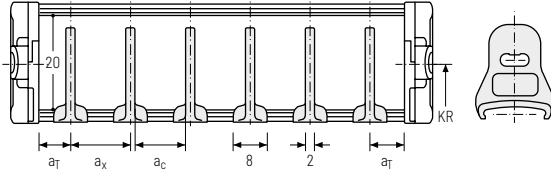

Order example



TSO
Divider system
.
A
Version
.
3
n_T

Please state the designation of the divider system (**TSO**), the version, and the number of dividers per cross section [n_T]. You are welcome to add a sketch to your order.

Cable carrier
Cable carrier configuration
Configuration guidelines
Materials information
MONO series
QuickTrax® series
UNIFLEX Advanced series
TKP35 series
TKK series
EasyTrax® series

Single-part end connectors – plastic (with integrated strain relief)

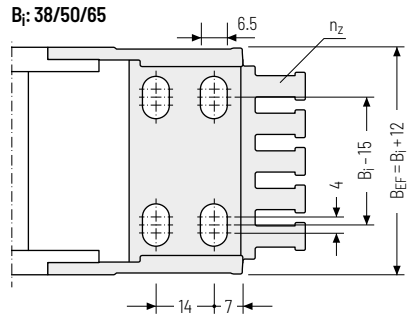
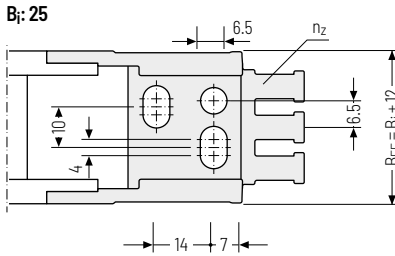
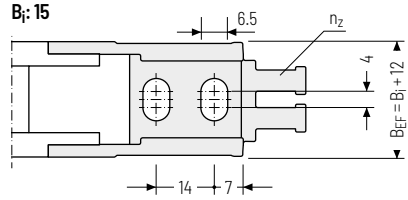
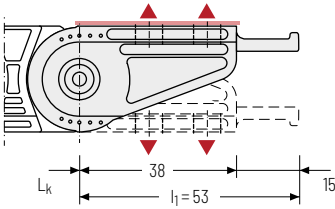
The plastic end connectors can be connected from above or below. The connection type can be changed by altering the position of the end connector.



▲ Assembly options

B_i [mm]	B_{EF} [mm]	n_z
15	27	2
25	37	3
38	50	4
50	62	5
65	77	6

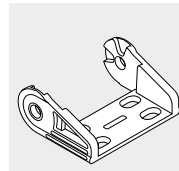

The end connectors are also available as an option **without** integrated strain relief. Please state when ordering.

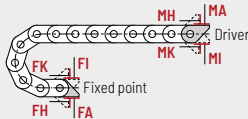

Connection point

- F** – fixed point
- M** – driver

Connection type

- A** – threaded joint outside (standard)
- I** – threaded joint inside
- H** – threaded joint, rotated 90° to the outside
- K** – threaded joint, rotated 90° to the inside

Order example

	End connector	F	A
	End connector	M	A
	End connector	Connection point	Connection type

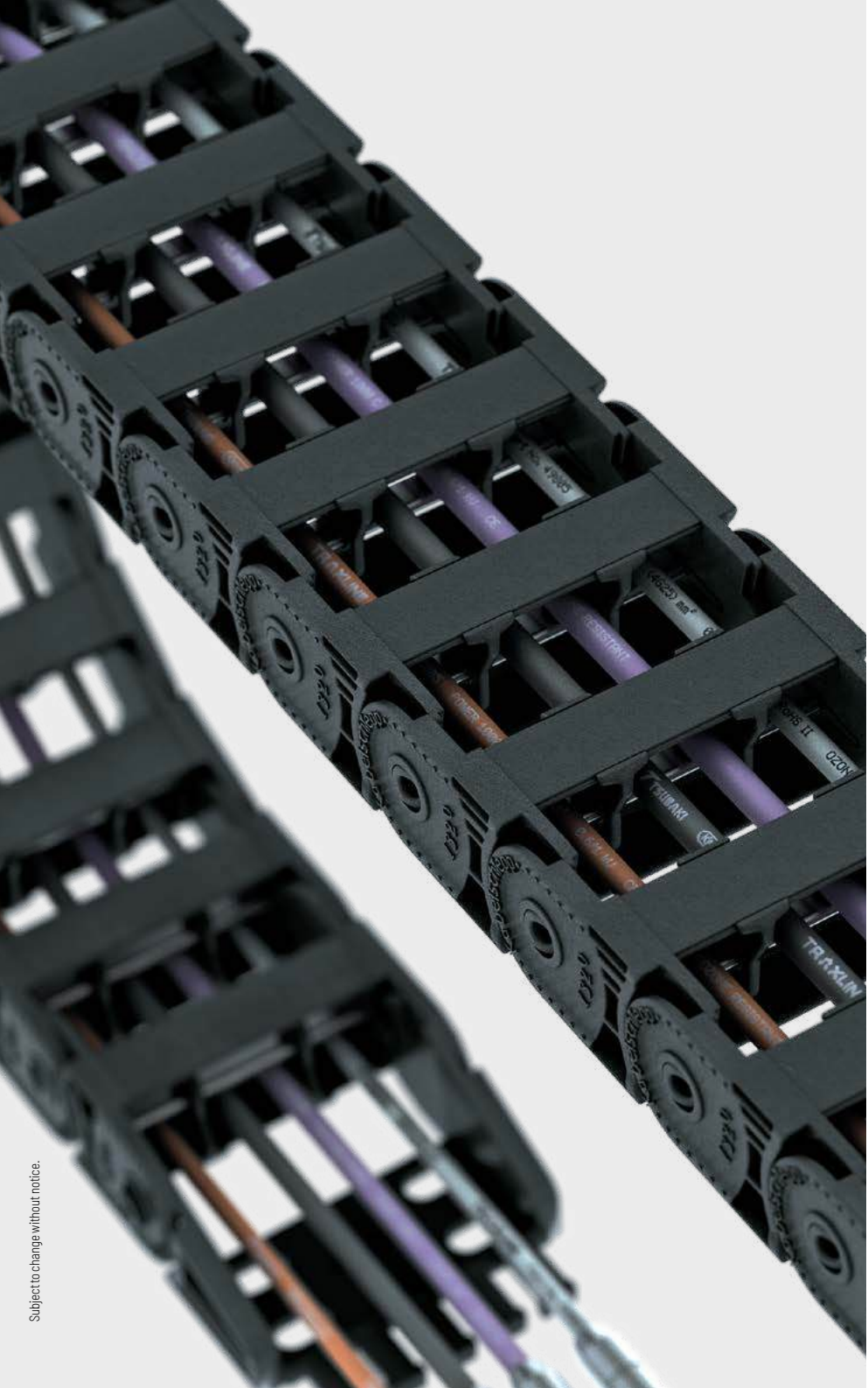

EasyTrax®
series

TKK
series

TKP35
series

UNIFLEX
Advanced
series

QuickTrax®
series

MONO
series

Materials
information

Configuration
guidelines

Cable carrier
configuration

Cable carrier

UA1455



Pitch
45.5 mm



Inner height
26 mm



Inner widths
25 – 130 mm



Bending radii
52 – 200 mm

Stay variants



Design 020 page 164

Closed frame

- » Weight-optimised, closed plastic frame with particularly high torsional rigidity.
- » **Outside/inside:** not openable.



Design 030 page 165

Frame with outside detachable stays

- » Weight-optimised plastic frame with particularly high torsional rigidity.
- » **Outside:** openable and detachable.



Design 040 page 166

Frame with inside detachable stays

- » Weight-optimised plastic frame with particularly high torsional rigidity.
- » **Inside:** openable and detachable.



EasyTrax®

For an openable cable carrier with 25 mm inner height we recommend the series EasyTrax® 1455 **ET1455 from page 256.**

Unsupported arrangement

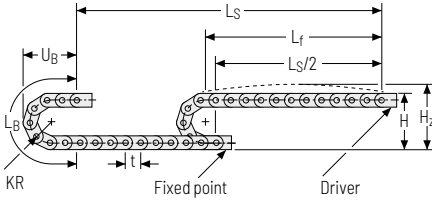





KR [mm]	H [mm]	H _z [mm]	L _B [mm]	U _B [mm]
52	140	165	255	116
65	166	191	296	129
95	226	251	390	159
125	286	311	484	189
150	336	361	563	214
180	396	421	657	244
200	436	461	720	264

Load diagram for unsupported length depending on the additional load.

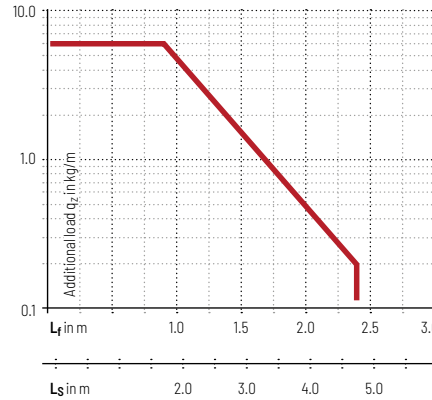
Sagging of the cable carrier is technically permitted for extended travel lengths, depending on the specific application.

Intrinsic cable carrier weight $q_k = 0.75 \text{ kg/m}$ with B_3 38 mm. For other inner widths, the maximum additional load changes.





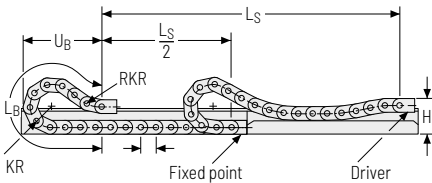

-  **Speed**
up to 10 m/s
-  **Acceleration**
up to 50 m/s^2
-  **Travel length**
up to 4.8 m
-  **Additional load**
up to 6 kg/m

Gliding arrangement | GO module with chain links optimized for gliding



KR [mm]	H [mm]	GO-Modul RKR [mm]	L _B [mm]	U _B [mm]
52	108	225	780	377
65	108	225	825	389
95	108	225	1007	450
125	108	225	1189	508
150	108	225	1371	573
180	108	225	1599	655
200	108	225	1781	723

-  **Speed**
up to 2.5 m/s
-  **Acceleration**
up to 20 m/s^2
-  **Travel length**
up to 120 m
-  **Additional load**
up to 6 kg/m

 The gliding cable carrier must be guided in a channel. See p. 844.

The GO module mounted on the driver is a defined sequence of 5 adapted KR/RKR link plates.

Glide shoes must be used for gliding applications.

Only designs 020 and 030 can be used for a gliding arrangement.

Stay variant 020 – closed frame

- » Weight-optimised, closed plastic frame with particularly high torsional rigidity.
- » **Outside/inside:** not openable.



Stay arrangement on each chain link (**VS: fully-stayed**)



B_i : 25 – 130 mm

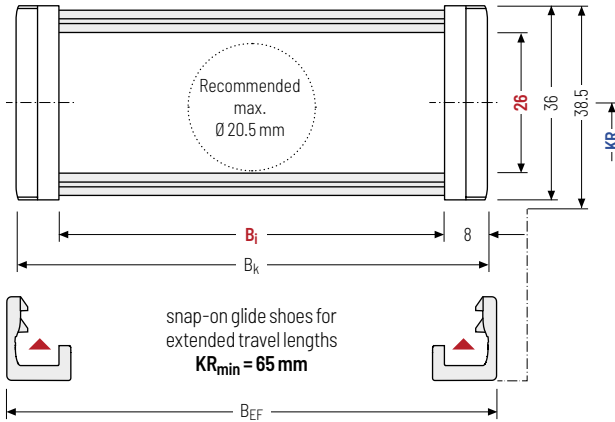

The maximum cable diameter strongly depends on the bending radius and the desired cable type. Please contact us.

Calculating the cable carrier length

Cable carrier length L_k

$$L_k \approx \frac{L_S}{2} + L_B$$

Cable carrier length L_k rounded to pitch t



Special version for support legs of commercial vehicles

Special versions for the safe guiding and separating of rigid hydraulic hoses and electric cables in a limited space in extendable support feet of commercial vehicles on request.

h_i [mm]	h_G [mm]	h_G' [mm]	B_i [mm]			B_k [mm]	B_{EF} [mm]	KR [mm]				q_k [kg/m]
26	36	38.5	25	38	58	$B_i + 16$	$B_i + 19$	52	65	95	125	0.71 - 1.12
			78	103	130			150	180	200		

Order example



UA1455

Type

020

Stay variant

78

B_i [mm]

150

KR [mm]

1456

L_k [mm]

VS

Stay arrangement

Stay variant 030 – with outside opening and detachable stays

- » Weight-optimised plastic frame with particularly high torsional rigidity.
- » Swivable and detachable left or right in any position.
- » **Outside:** openable and detachable.

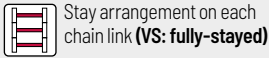

Stay arrangement on each chain link (**VS: fully-stayed**)



B_i : 25 – 130 mm

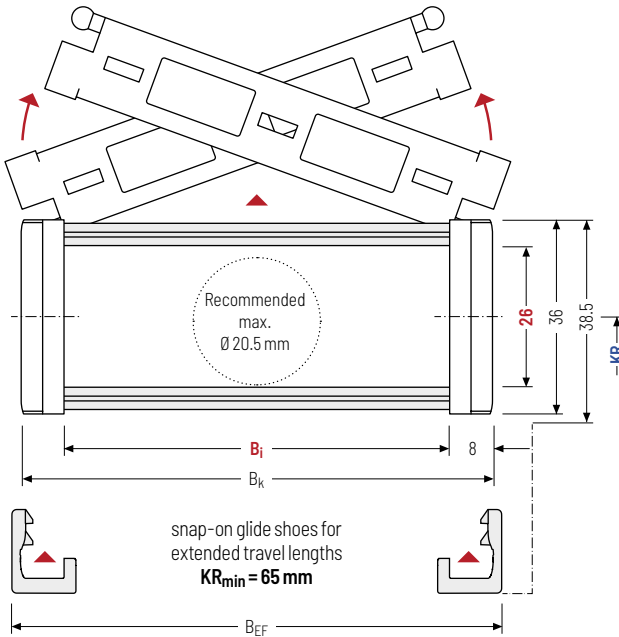

i The maximum cable diameter strongly depends on the bending radius and the desired cable type. Please contact us.

Calculating the cable carrier length

Cable carrier length L_k

$$L_k \approx \frac{L_S}{2} + L_B$$

Cable carrier length L_k rounded to pitch t

h_i [mm]	h_G [mm]	$h_{G'}$ [mm]	B_i [mm]			B_k [mm]	B_{EF} [mm]	KR [mm]				q_k [kg/m]
26	36	38.5	25	38	58	$B_i + 16$	$B_i + 19$	52	65	95	125	0.73 – 1.10
			78	103	130			150	180	200		

Order example

UA1455 ·
 030 ·
 78 ·
 150 ·
 1456 ·
 VS
 Type Stay variant B_i [mm] KR [mm] L_k [mm] Stay arrangement

Stay variant 040 – with inside opening and detachable stays

- » Weight-optimised plastic frame with particularly high torsional rigidity.
- » Swivable and detachable left or right in any position.
- » **Inside:** openable and detachable.



Stay arrangement on each chain link (**VS: fully-stayed**)



B_i : 25 – 130 mm

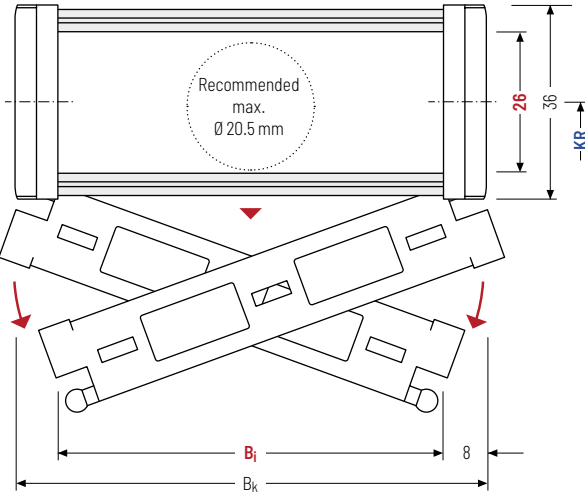

The maximum cable diameter strongly depends on the bending radius and the desired cable type. Please contact us.



Design 040 is not suitable for gliding arrangements.

Calculating the cable carrier length

Cable carrier length L_k

$$L_k \approx \frac{L_S}{2} + L_B$$

Cable carrier length L_k rounded to pitch t

h_i [mm]	h_g [mm]	B_i [mm]			B_k [mm]	KR [mm]				q_k [kg/m]
26	36	25	38	58	$B_i + 16$	52	65	95	125	0.73 – 1.10
		78	103	130		150	180	200		

Order example

UA1455 Type ·
 040 Stay variant ·
 78 B_i [mm] ·
 150 KR [mm] ·
 1456 L_k [mm] ·
 VS Stay arrangement

Divider systems

The divider system is mounted on every 2nd chain link as a standard.

As a standard, dividers or the complete divider system (dividers with height separations) are movable in the cross section (**version A**).

For applications with lateral acceleration and lying on the side, divider with arresting cams are available.

The locking cams click into place in the locking grids in the stays (**version B**).

Divider system TSO without height separation

Vers.	a _T min [mm]	a _x min [mm]	a _c min [mm]	a _x grid [mm]	η _T min
A	3.5	7	5	-	-
B*	4/5**	7.5	5.5	2.5	-

Number of dividers for design Q20 depending on B_i
 * not for design Q20
 ** 4 mm for B_i 38 - 103; 5 mm for B_i 25, 130

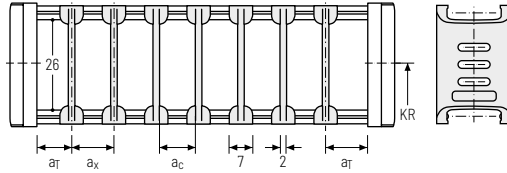

Divider system TS1 with continuous height separation*

Vers.	a _T min [mm]	a _T max [mm]	a _x min [mm]	a _c min [mm]	a _x grid [mm]	η _T min
A	3.5	20	7	5	-	2
B	4/5**	20	7.5	5.5	2.5	2

* not for design Q20
 ** 4 mm for B_i 38 - 103; 5 mm for B_i 25, 130

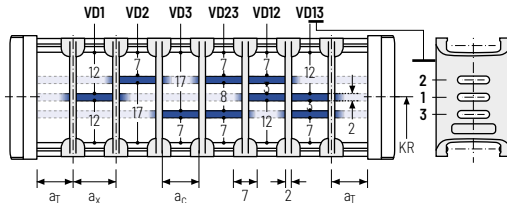

Divider system TS3 with height separation consisting of plastic section subdivisions

Vers.	a _T min [mm]	a _x min [mm]	a _c min [mm]	η _T min
A	3.5	15	10	2

The dividers are fixed with the section subdivision. The entire divider system can be moved in the cross section.

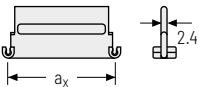
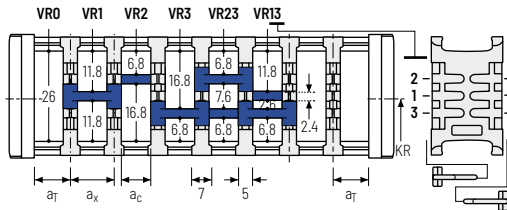

a _x (centre distance of dividers) [mm]									
a _c (usable width of inner chamber) [mm]									
15	20	25	30	35	40	45	55	65	75
10	15	20	25	30	35	40	50	60	70

Order example

TS3 ·
 A ·
 2 ·
 K1 ·
 34 -
 VR1
 ⋮ ⋮ ⋮
 · K4 ·
 38 -
 VR3

Divider system Version η_T Chamber a_x Height separation

Cable carrier
Cable carrier configuration
Configuration guidelines
Materials information
MONO series
QuickTrax® series
UNIFLEX Advanced series
TKP35 series
TKK series
EasyTrax® series

Universal end connectors UMB – plastic (standard)

The universal mounting brackets (UMB) are made from plastic and can be mounted **from above, from below or on the face side**.

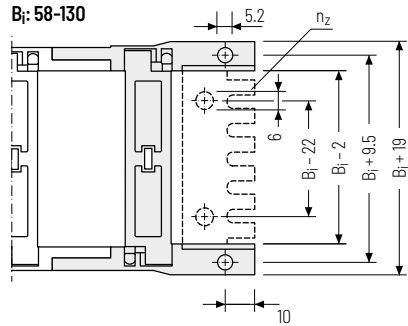
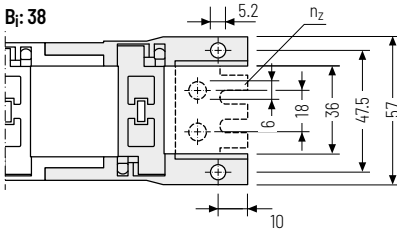
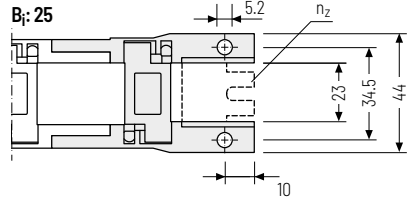
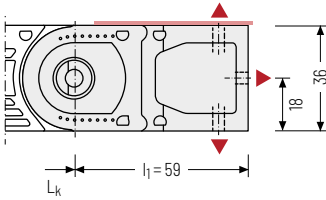

Recommended tightening torque:
5 Nm for screws M5 - 8.8

Assembly options

B_i [mm]	n_z
25	2
38	3
58	5
78	7
103	9
130	11

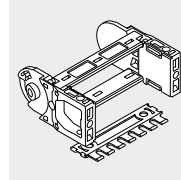

The end connectors are optionally also available **with strain relief comb** (1 on each side). Please state when ordering.

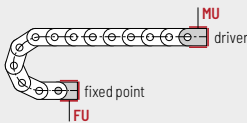

Connection point
F – fixed point
M – driver

Connection type
U – Universal mounting bracket

Order example

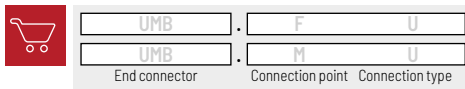

Single-part end connectors short – plastic

The plastic end connectors can be connected **from above or below**. The connection type can be changed by altering the position of the end connector.

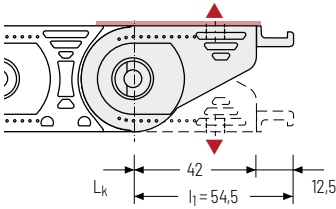

B_i: 25

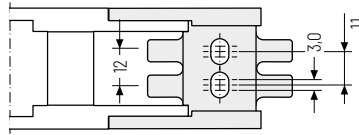

B_i: 38-130

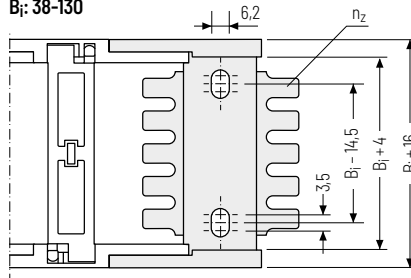

Recommended tightening torque:
6 Nm for screws M6 – 8.8

B _i [mm]	n _z
25	2 x 2
38	2 x 3
58	2 x 4
78	2 x 6
103	2 x 8
130	2 x 10

▲ Assembly options

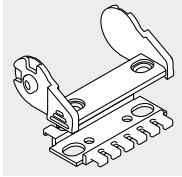

The end connectors are optionally also available **without** strain relief comb (except B_i 25). Please state when ordering.

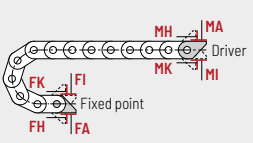

Connection point
F – fixed point
M – driver

Connection type
A – threaded joint outside (standard)
I – threaded joint inside
H – threaded joint, rotated 90° to the outside
K – threaded joint, rotated 90° to the inside

Order example



End connector	F	A
End connector	M	A
End connector	Connection point	Connection type

Cable carrier
Cable carrier configuration
Configuration guidelines
Materials information
MONO series
QuickTrax® series
UNIFLEX Advanced series
TKP35 series
TKK series
EasyTrax® series

Single-part end connectors long – plastic

The plastic end connectors can be connected **from above or below** and allow a **1:1 replacement of the UNIFLEX 0455 in the connection area**. The connection type can be changed by altering the position of the end connector.

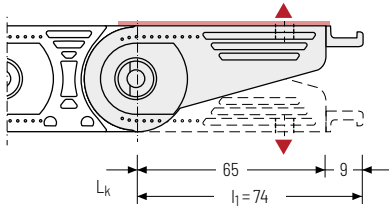

B_i: 25

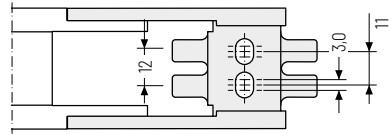

B_i: 38-130

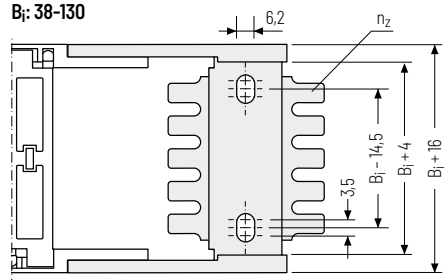

▲ Assembly options

 Recommended tightening torque:
6 Nm for screws M6 - 8.8 and washers

B _i [mm]	n ₂
25	2 x 2
38	2 x 3
58	2 x 4
78	2 x 6
103	2 x 8
130	2 x 10

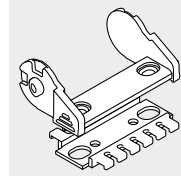

The end connectors are optionally also available **without strain relief comb** (except B_i 25). Please state when ordering.

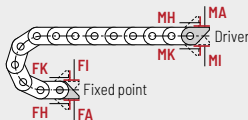

Connection point

F – fixed point
M – driver

Connection type

A – threaded joint outside (standard)
I – threaded joint inside
H – threaded joint, rotated 90° to the outside
K – threaded joint, rotated 90° to the inside

Order example



End connector U0455

F A

End connector U0455

M A

End connector

Connection point Connection type



EasyTrax®
series

TKK
series

TKP35
series

UNIFLEX
Advanced
series

QuickTrax®
series

MONO
series

Materials
information

Configuration
guidelines

Cable carrier
configuration

Cable carrier

UA1555



Pitch
55.5 mm



Inner height
38 mm



Inner widths
50 – 150 mm



Bending radii
63 – 200 mm

Stay variants



Design 020 page 174

Closed frame

- » Weight-optimised, closed plastic frame with particularly high torsional rigidity.
- » **Outside/inside:** not openable.



Design 030 page 175

Frame with outside detachable stays

- » Weight-optimised plastic frame with particularly high torsional rigidity.
- » **Outside:** openable and detachable.



Design 040 page 176

Frame with inside detachable stays

- » Weight-optimised plastic frame with particularly high torsional rigidity.
- » **Inside:** openable and detachable.

Additional product information online



Installation instructions, etc.:
Additional info via your smartphone or
check online at
[tsubaki-kabelschlepp.com/
downloads](http://tsubaki-kabelschlepp.com/downloads)



Configure your cable carrier here:
online-engineer.de

Unsupported arrangement

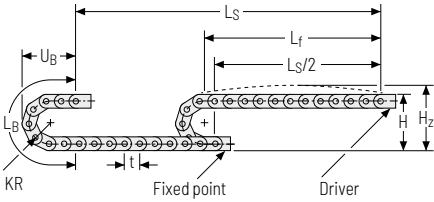





KR [mm]	H [mm]	H _z [mm]	L _B [mm]	U _B [mm]
63	176	216	309	145
80	210	240	362	165
100	250	280	425	185
125	300	330	504	210
160	370	400	614	245
200	450	480	740	285

Load diagram for unsupported length depending on the additional load.

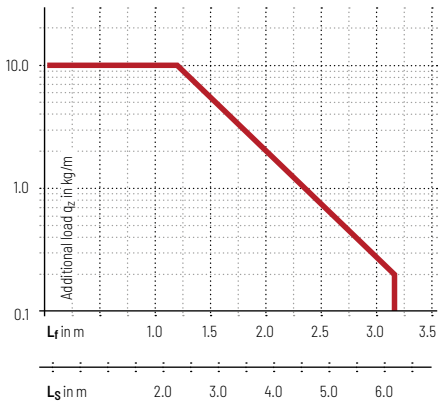
Sagging of the cable carrier is technically permitted for extended travel lengths, depending on the specific application.

Intrinsic cable carrier weight $q_k = 1.32 \text{ kg/m}$ with $B_i 100 \text{ mm}$. For other inner widths, the maximum additional load changes.





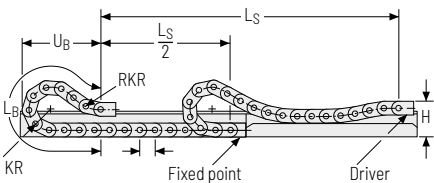

-  **Speed**
up to 9 m/s
-  **Acceleration**
up to 45 m/s²
-  **Travel length**
up to 6.3 m
-  **Additional load**
up to 10 kg/m

Gliding arrangement | GO module with chain links optimized for gliding



KR [mm]	H [mm]	GO-Modul RKR [mm]	L _B [mm]	U _B [mm]
63	150	250	939	458
80	150	250	994	473
100	150	250	1105	510
125	150	250	1272	567
160	150	250	1438	612
200	150	250	1771	730

-  **Speed**
up to 3 m/s
-  **Acceleration**
up to 20 m/s²
-  **Travel length**
up to 125 m
-  **Additional load**
up to 10 kg/m

 The gliding cable carrier must be guided in a channel. See p. 844.

The GO module mounted on the driver is a defined sequence of 5 adapted KR/RKR link plates.

Glide shoes must be used for gliding applications. Only designs 020 and 030 can be used for a gliding arrangement.

Cable carrier
Cable carrier configuration
Configuration guidelines
Materials information
MONO series
QuickTrax® series
UNIFLEX Advanced series
TKP35 series
TKK series
EasyTrax® series

Stay variant 020 – closed frame

- » Weight-optimised, closed plastic frame with particularly high torsional rigidity.
- » **Outside/inside:** not openable.



Stay arrangement on each chain link (**VS: fully-stayed**)



B_i : 50 – 150 mm

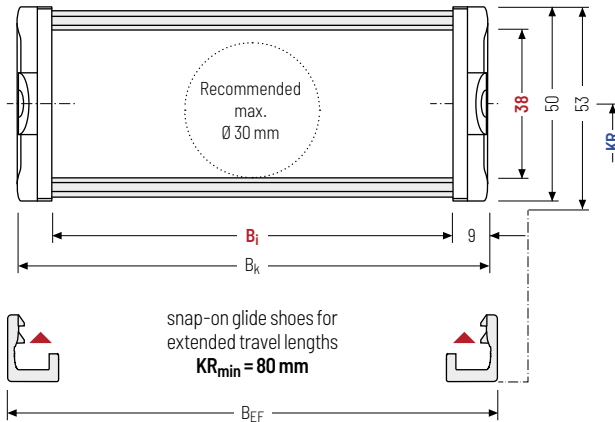

The maximum cable diameter strongly depends on the bending radius and the desired cable type. Please contact us.

Calculating the cable carrier length

Cable carrier length L_k

$$L_k \approx \frac{L_S}{2} + L_B$$

Cable carrier length L_k
rounded to pitch t

h_i [mm]	h_G [mm]	h_G' [mm]	B_i [mm]			B_k [mm]	B_{EF} [mm]	KR [mm]				q_k [kg/m]
38	50	53	50	75	100	$B_i + 18$	$B_i + 22$	63	80	100	125	1.13 – 1.52
			125	150	160			200				

Order example



UA1555

Type

020

Stay variant

125

B_i [mm]

160

KR [mm]

1887

L_k [mm]

VS

Stay arrangement

Stay variant 030 – with outside opening and detachable stays

- » Weight-optimised plastic frame with particularly high torsional rigidity.
- » Swivable and detachable left or right in any position.
- » **Outside:** openable and detachable.

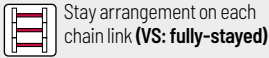

Stay arrangement on each chain link (VS: fully-stayed)



B_i: 50 - 150 mm

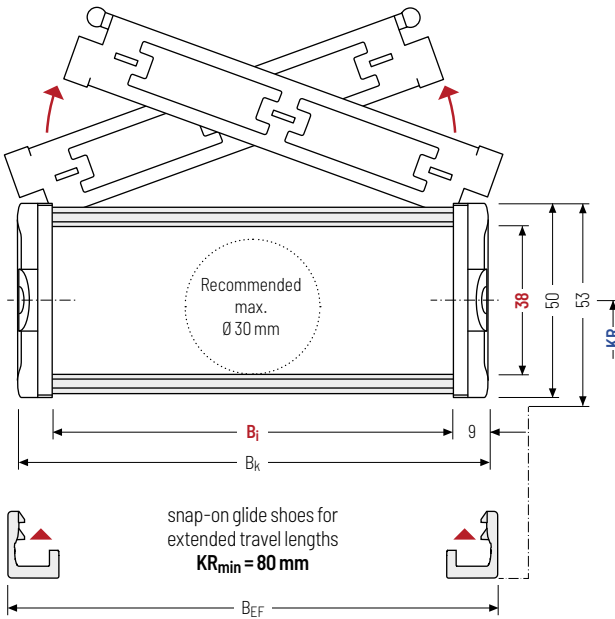

i The maximum cable diameter strongly depends on the bending radius and the desired cable type. Please contact us.

Calculating the cable carrier length

Cable carrier length L_k

$$L_k \approx \frac{L_S}{2} + L_B$$

Cable carrier length L_k rounded to pitch t

h _i [mm]	h _G [mm]	h _G ' [mm]	B _i [mm]			B _k [mm]	B _{EF} [mm]	KR [mm]				q _k [kg/m]
38	50	53	50	75	100	B _i + 18	B _i + 22	63	80	100	125	1.13 - 1.51
			125	150	160			200				

Order example

UA1555 ·
 030 ·
 125 ·
 160 ·
 1887 ·
 VS
 Type Stay variant B_i [mm] KR [mm] L_k [mm] Stay arrangement

Cable carrier
Cable carrier configuration
Configuration guidelines
Materials information
MONO series
QuickTrax® series
UNIFLEX Advanced series
TKP35 series
TKK series
EasyTrax® series

Stay variant 040 – with inside opening and detachable stays

- » Weight-optimised plastic frame with particularly high torsional rigidity.
- » Swivable and detachable left or right in any position.
- » **Inside:** openable and detachable.



Stay arrangement on each chain link (**VS: fully-stayed**)



B_i : 50 - 150 mm

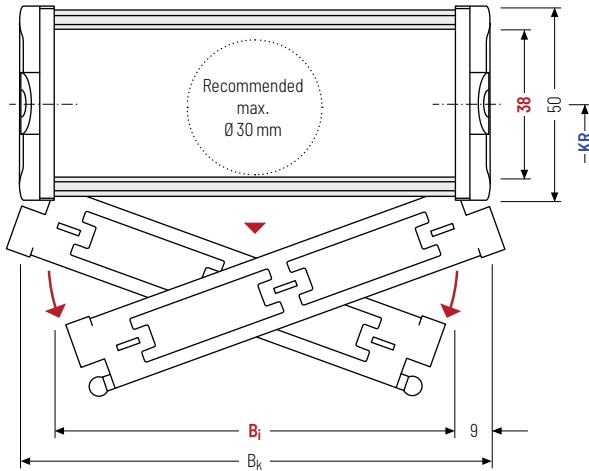

The maximum cable diameter strongly depends on the bending radius and the desired cable type. Please contact us.

Design 040 is not suitable for gliding arrangements.

Calculating the cable carrier length

Cable carrier length L_k

$$L_k \approx \frac{L_S}{2} + L_B$$

Cable carrier length L_k rounded to pitch t

h_i [mm]	h_g [mm]	h_g' [mm]	B_i [mm]			B_k [mm]	KR [mm]				q_k [kg/m]
38	50	53	50	75	100	$B_i + 18$	63	80	100	125	1.13 - 1.52
			125	150			160	200			

Order example



UA1555

Type

040

Stay variant

125

B_i [mm]

160

KR [mm]

1887

L_k [mm]

VS

Stay arrangement

Divider systems

The divider system is mounted on every 2nd chain link as a standard.

For applications with lateral acceleration and lying on the side, divider with arresting cams are available.

As a standard, dividers or the complete divider system (dividers with height separations) are movable in the cross section (**version A**).

The locking cams click into place in the locking grids in the stays (**version B**).

Divider system TSO without height separation

Vers.	a _T min [mm]	a _x min [mm]	a _c min [mm]	a _x grid [mm]	n _T min
A	5	10	7.5	-	-
B*	5	10	7.5	2.5	-

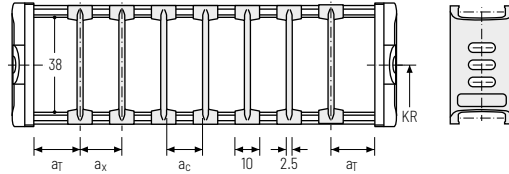

Number of dividers for design Q20 depending on B_i
* not for design Q20

Divider system TS1 with continuous height separation*

Vers.	a _T min [mm]	a _T max [mm]	a _x min [mm]	a _c min [mm]	a _x grid [mm]	n _T min
A	5	20	10	7.5	-	2
B	5	20.5	10	7.5	2.5	2

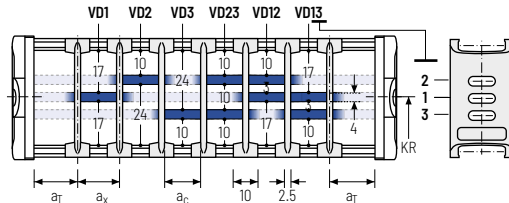

* not for design Q20

Divider system TS3 with height separation consisting of plastic section subdivisions

Vers.	a _T min [mm]	a _x min [mm]	a _c min [mm]	n _T min
A	5	15	10	2

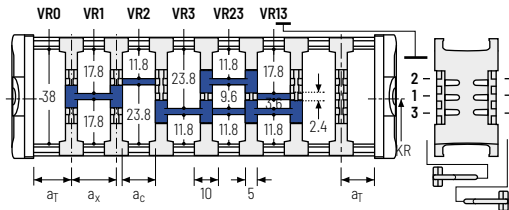

* not for design Q20

The dividers are fixed with the partitions. The entire divider system can be moved in the cross section.

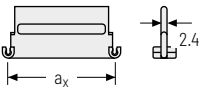

a _x (centre distance of dividers) [mm]									
a _c (usable width of inner chamber) [mm]									
15	20	25	30	35	40	45	55	65	75
10	15	20	25	30	35	40	50	60	70

Order example

TS3

·

A

·

2

·

K1

·

34

-

VR1

⋮

⋮

⋮

·

K4

·

38

-

VR3

Divider system

Version

n_T

Chamber

a_x

Height separation

Cable carrier
Cable carrier configuration
Configuration guidelines
Materials information
MONO series
QuickTrax® series
UNIFLEX Advanced series
TKP35 series
TKK series
EasyTrax® series

Universal end connectors UMB – plastic (standard)

The universal mounting brackets (UMB) are made from plastic and can be mounted **from above, from below or on the face side**.

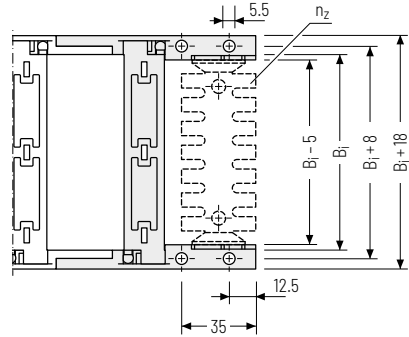
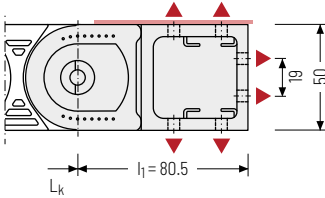

▲ Assembly options

 Recommended tightening torque:
5 Nm for screws M5 - 8.8

B_1 [mm]	n_z
50	2 x 3
75	2 x 5
90	2 x 6
100	2 x 7
125	2 x 9
150	2 x 11

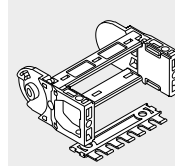

The end connectors are optionally also available **with** strain relief comb or **with** C-rail Art. no. 3931 (1 on each side) for clamps. Please state when ordering.

UNIFLEX
Advanced
series

TKP35
series

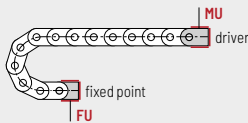

Connection point

F – fixed point
M – driver

Connection type

U – Universal mounting bracket

TKK
series

Order example

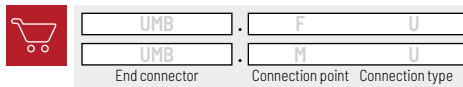

 We recommend the use of strain reliefs at the driver and fixed point. See from p. 904.

EasyTrax®
series

Single-part end connectors short – plastic

The plastic end connectors can be **connected from above or below**. The connection type can be changed by altering the position of the end connector.

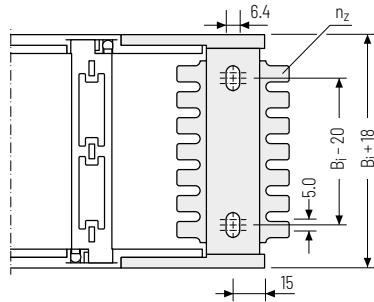
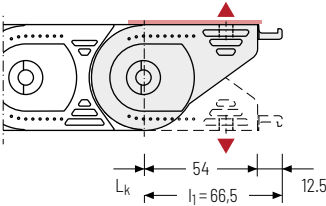

▲ Assembly options

Recommended tightening torque:
6 Nm for screws M6 - 8.8

B_i [mm]	n_z
50	2 x 4
75	2 x 6
100	2 x 8
125	2 x 10
150	2 x 12

The end connectors are optionally also available **without** strain relief comb. Please state when ordering.

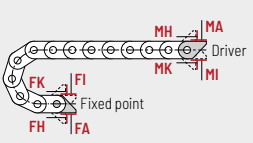

Connection point
F - fixed point
M - driver

Connection type
A - threaded joint outside (standard)
I - threaded joint inside
H - threaded joint, rotated 90° to the outside
K - threaded joint, rotated 90° to the inside

Order example

End connector	.	F	A
End connector	.	M	A
End connector		Connection point	Connection type

Cable carrier
Cable carrier configuration
Configuration guidelines
Materials information
MONO series
QuickTrax® series
UNIFLEX Advanced series
TKP35 series
TKK series
EasyTrax® series

Single-part end connectors long – plastic

The plastic end connectors can be connected **from above or below** and allow a **1:1 replacement of the UNIFLEX 0555 in the connection area**. The connection type can be changed by altering the position of the end connector.

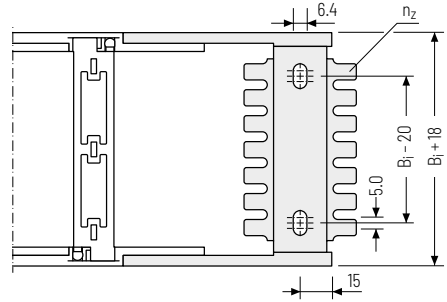
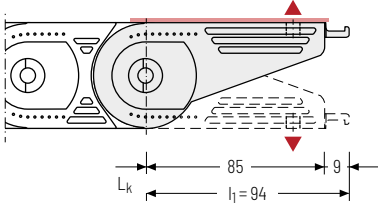

▲ Assembly options



Recommended tightening torque:
6 Nm for screws M6 - 8.8 and washers

B_1 [mm]	n_z
50	2 x 4
75	2 x 6
100	2 x 8
125	2 x 10
150	2 x 12

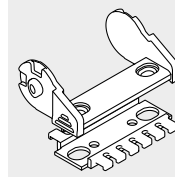

The end connectors are optionally also available **without** strain relief comb.
Please state when ordering.

UNIFLEX
Advanced
series

TKP35
series

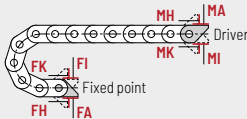

Connection point

F – fixed point
M – driver

Connection type

A – threaded joint outside (standard)
I – threaded joint inside
H – threaded joint, rotated 90° to the outside
K – threaded joint, rotated 90° to the inside

Order example



End connector U0555

F A

End connector U0555

M A

End connector

Connection point Connection type

EasyTrax®
series



Subject to change without notice.

EasyTrax®
series

TKK
series

TKP35
series

UNIFLEX
Advanced
series

QuickTrax®
series

MONO
series

Materials
information

Configuration
guidelines

Cable carrier
configuration

Cable carrier

UA1665



Pitch
66.5 mm



Inner height
44 mm



Inner widths
50 – 250 mm

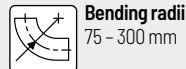

Bending radii
75 – 300 mm

Stay variants



Design 020 page 184

Closed frame

- » Weight-optimised, closed plastic frame with particularly high torsional rigidity.
- » **Outside/inside:** not openable.



Design 030 page 185

Frame with outside detachable stays

- » Weight-optimised plastic frame with particularly high torsional rigidity.
- » **Outside:** openable and detachable.



Design 040 page 186

Frame with inside detachable stays

- » Weight-optimised plastic frame with particularly high torsional rigidity.
- » **Inside:** openable and detachable.



Design RMA page 188

Mounting frame stay

- » Weight-optimised plastic frame with particularly high torsional rigidity.
- » **Outside/inside:** threaded joint easy to release.

Unsupported arrangement

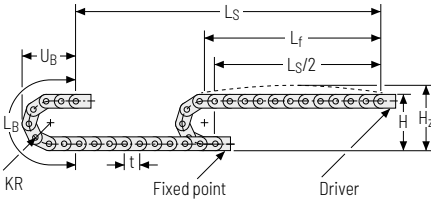

KR [mm]	H [mm]	H _z [mm]	L _B [mm]	U _B [mm]
75	210	245	369	172
100	260	295	448	197
120	300	335	511	217
140	340	375	574	237
200	460	495	762	297
250	560	595	919	347
300	660	695	1076	397

Load diagram for unsupported length depending on the additional load.

Sagging of the cable carrier is technically permitted for extended travel lengths, depending on the specific application.

Intrinsic cable carrier weight $q_k = 2.43 \text{ kg/m}$ with B_3 200 mm. For other inner widths, the maximum additional load changes.

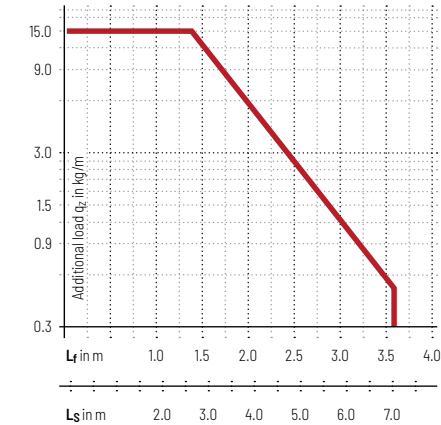

- Speed**
up to 8 m/s
- Acceleration**
up to 40 m/s²
- Travel length**
up to 7 m
- Additional load**
up to 15 kg/m

Cable carrier
Cable carrier configuration
Configuration guidelines
Materials information
MONO series

Gliding arrangement | GO module with chain links optimized for gliding

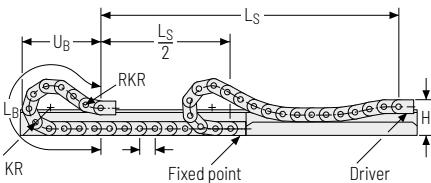

KR [mm]	H [mm]	GO-Modul RKR [mm]	L _B [mm]	U _B [mm]
75	180	300	1118	546
100	180	300	1251	593
120	180	300	1318	609
140	180	300	1450	654
200	180	300	1783	753
250	180	300	2182	864
300	180	300	2581	1035

- Speed**
up to 3 m/s
- Acceleration**
up to 15 m/s²
- Travel length**
up to 150 m
- Additional load**
up to 15 kg/m

The gliding cable carrier must be guided in a channel. See p. 844.

The GO module mounted on the driver is a defined sequence of 5 adapted KR/RKR link plates.

Glide shoes must be used for gliding applications.

Only designs 020 and 030 can be used for a gliding arrangement.

QuickTrax® series
UNIFLEX Advanced series
TKP35 series
TKK series
EasyTrax® series

Stay variant 020 – closed frame

- » Weight-optimised, closed plastic frame with particularly high torsional rigidity.
- » **Outside/inside:** not openable.



Stay arrangement on each chain link (**VS: fully-stayed**)



B: 50 - 250 mm

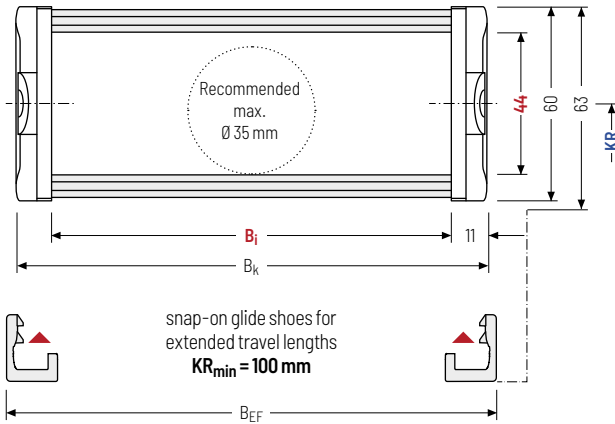

The maximum cable diameter strongly depends on the bending radius and the desired cable type. Please contact us.

Calculating the cable carrier length

Cable carrier length L_k

$$L_k \approx \frac{L_S}{2} + L_B$$

Cable carrier length L_k
rounded to pitch t

h_i [mm]	h_g [mm]	h_g' [mm]	B_i [mm]					B_k [mm]	B_{EF} [mm]	KR [mm]				q_k [kg/m]
44	60	63	50	75	100	125	150	$B_i + 22$	$B_i + 27$	75	100	120	140	1.67 - 2.76
			175	200	225	250			200	250	300			

Order example



UA1665

Type

020

Stay variant

125

B_i [mm]

140

KR [mm]

2660

L_k [mm]

VS

Stay arrangement

Stay variant 030 – with outside opening and detachable stays

- » Weight-optimised plastic frame with particularly high torsional rigidity.
- » Swivable and detachable left or right in any position.
- » **Outside:** openable and detachable.



Stay arrangement on each chain link (**VS: fully-stayed**)

B_i 50 – 250 mm

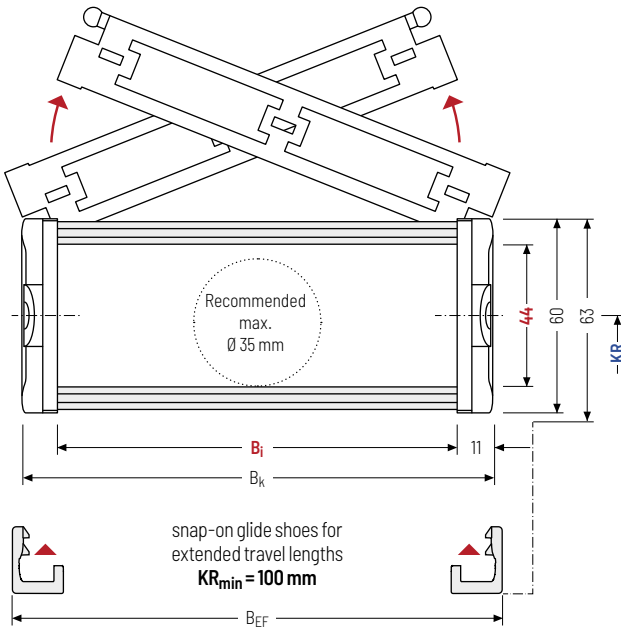

The maximum cable diameter strongly depends on the bending radius and the desired cable type. Please contact us.

Calculating the cable carrier length

Cable carrier length L_k

$$L_k \approx \frac{L_S}{2} + L_B$$

Cable carrier length L_k rounded to pitch t

h_i [mm]	h_G [mm]	h_G' [mm]	B_i [mm]					B_k [mm]	B_{EF} [mm]	KR [mm]				q_k [kg/m]
44	60	63	50	75	100	125	150	$B_i + 22$	$B_i + 27$	75	100	120	140	1.67 – 2.70
			175	200	225	250			200	250	300			

Order example

UA1665 ·
 030 ·
 125 ·
 140 ·
 2660 ·
 VS
 Type Stay variant B_i [mm] KR [mm] L_k [mm] Stay arrangement

Cable carrier
Cable carrier configuration
Configuration guidelines
Materials information
MONO series
QuickTrax® series
UNIFLEX Advanced series
TKP35 series
TKK series
EasyTrax® series

Stay variant 040 – with inside opening and detachable stays

- » Weight-optimised plastic frame with particularly high torsional rigidity.
- » Swivable and detachable left or right in any position.
- » **Inside:** openable and detachable.



Stay arrangement on each chain link (**VS: fully-stayed**)



B_i : 50 - 250 mm

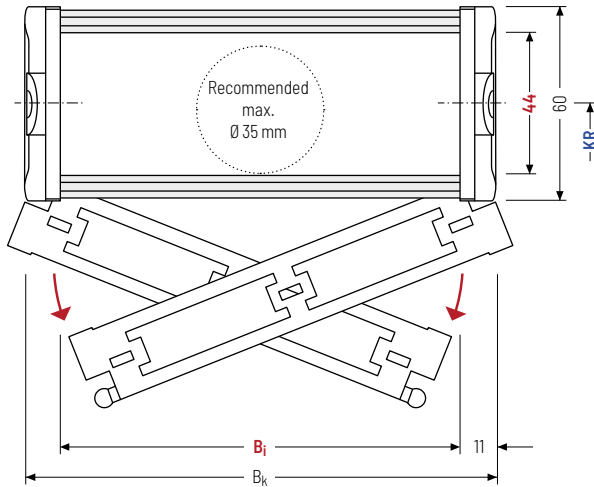

The maximum cable diameter strongly depends on the bending radius and the desired cable type. Please contact us.



Design 040 is not suitable for gliding arrangements.

Calculating the cable carrier length

Cable carrier length L_k

$$L_k \approx \frac{L_S}{2} + L_B$$

Cable carrier length L_k rounded to pitch t

h_i [mm]	h_G [mm]	B_i [mm]					B_k [mm]	KR [mm]				q_k [kg/m]
44	60	50	75	100	125	150	$B_i + 22$	75	100	120	140	1.67 - 2.70
		175	200	225	250			200	250	300		

Order example



UA1665

Type

040

Stay variant

125

B_i [mm]

140

KR [mm]

2660

L_k [mm]

VS

Stay arrangement

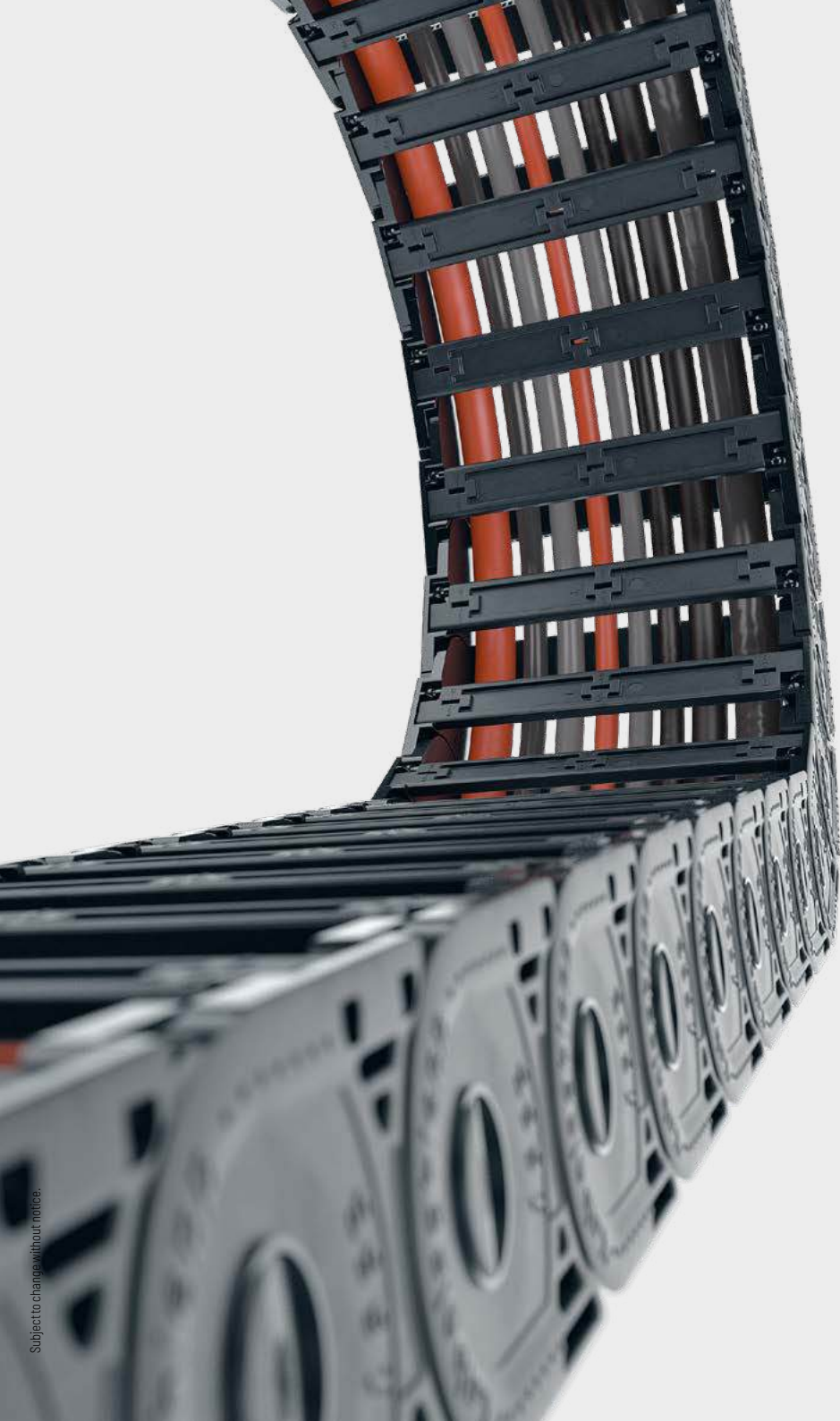

EasyTrax®
series

TKK
series

TKP35
series

UNIFLEX
Advanced
series

QuickTrax®
series

MONO
series

Materials
information

Configuration
guidelines

Cable carrier
configuration

Cable carrier

Stay variant RMA - mounting frame stay

- » Weight-optimized plastic frame with particularly high torsional rigidity.
- » Plastic stays and aluminum profile bars with plastic mounting frame stays for guiding very large cable diameters.
- » **Outside/inside:** threaded joint easy to release.

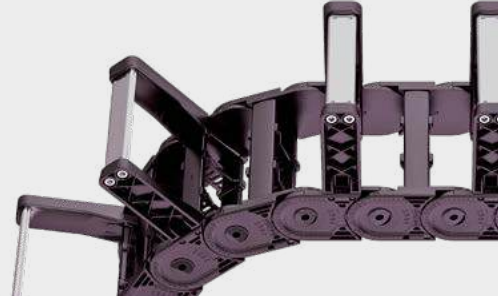

Stay arrangement on each chain link (**VS: fully-stayed**)



B_i 125 - 200 mm

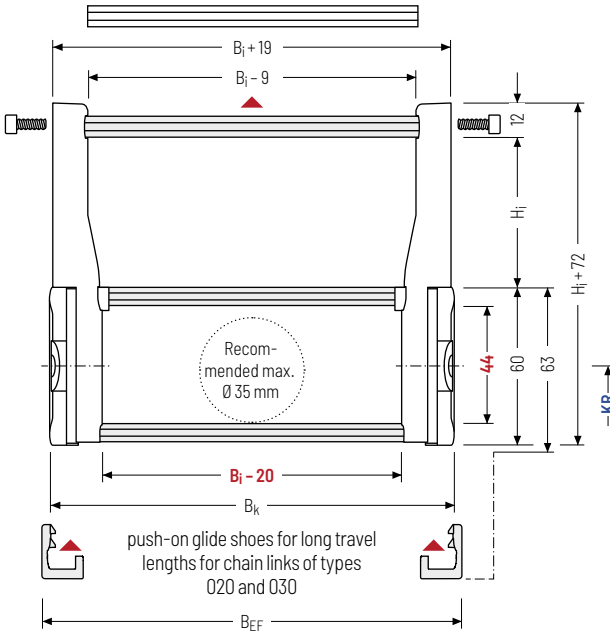

The maximum cable diameter strongly depends on the bending radius and the desired cable type. Please contact us.

Calculating the cable carrier length

Cable carrier length L_k

$$L_k \approx \frac{L_S}{2} + L_B$$

Cable carrier length L_k rounded to pitch t

UNIFLEX
Advanced
series

TKP35
series

TKK
series

EasyTrax®
series

h_i [mm]	h_g [mm]	H_i [mm]	B_i [mm]	B_k [mm]	B_{EF} [mm]	KR [mm]				q_k (RMAI)* [kg/m]	q_k (RMAO)* [kg/m]		
44	60	114	139	125	150	$B_i + 22$	$B_i + 27$	75	100	120	140	3.10 - 3.95	3.58 - 4.66
		164	189	175	200			200	250	300			

* indicated according to standard pitch

Order example



UA1665

Type

030

Stay variant

150

B_i [mm]

140

KR [mm]

2660

L_k [mm]

RMAO

Stay arrangement

Assembly variants

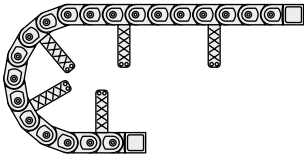

RMAI – assembly to the inside:

standard pitch, mounting frame stay on every 4th stay, no screw fixing.

Gliding application is not possible when using assembly version RMAI.

Observe minimum KR:

H_i = 114 mm: KR_{min} = 200 mm

H_i = 139 mm: KR_{min} = 250 mm

H_i = 164 mm: KR_{min} = 300 mm

H_i = 189 mm: KR_{min} = 300 mm

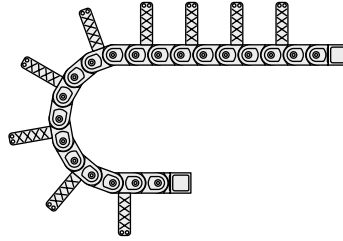

RMAO – assembly to the outside:

standard pitch, mounting frame stay on every 2nd stay, screw fixing.

The cable carrier rests on the bars. A bracket must be provided for the fixed point.

Guiding in a **channel is required** for support. Please contact our technical support at technik@kabelschlepp.de to find the corresponding guide channel.

Please note the operating and installation height.

Cross section mounting frame stay

To achieve a nearly square cross section in the mounting frame stay, we recommend the following combination of B_i and H_i:

B _i [mm]	H _i [mm]	KR _{min} [mm]	Stays [mm]
125	114	200	100
150	139	250	125
175	164	300	150
200	189	300	175

Cable carrier

Cable carrier configuration

Configuration guidelines

Materials information

MONO series

QuickTrax® series

UNIFLEX Advanced series

TKP35 series

TKK series

EasyTrax® series



TOTALTRAX® complete systems

Benefit from the advantages of the TOTALTRAX® complete system. A complete delivery from one source – with a warranty certificate on request! Learn more at tsubaki-kabelschlepp.com/totaltrax



TRAXLINE® cables for cable carriers

Hi-flex electric cables which were specially developed, optimised and tested for use in cable carriers can be found at tsubaki-kabelschlepp.com/traxline.

EasyTrax®
seriesTKK
seriesTKP35
seriesUNIFLEX
Advanced
seriesQuickTrax®
seriesMONO
seriesMaterials
informationConfiguration
guidelinesCable carrier
configuration

Cable carrier



Divider systems

The divider system is mounted on every 2nd chain link as a standard.

For applications with lateral acceleration and lying on the side, divider with arresting cams are available.

As a standard, dividers or the complete divider system (dividers with height separations) are movable in the cross section (**version A**).

The locking cams click into place in the locking grids in the stays (**version B**).

Divider system TSO without height separation

Vers.	a _T min [mm]	a _x min [mm]	a _c min [mm]	a _x grid [mm]	η _T min
A	5	10	7	-	-
B*	5	10	7	2.5	-

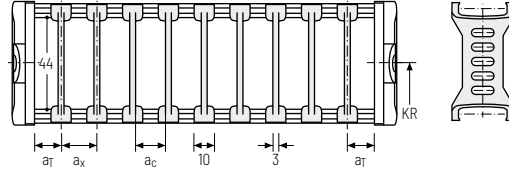

Number of dividers for design Q20 depending on B_i
* not for design Q20

Divider system TS1 with continuous height separation*

Vers.	a _T min [mm]	a _T max [mm]	a _x min [mm]	a _c min [mm]	a _x grid [mm]	η _T min
A	5	20	10	7	-	2
B	5	20	10	7	2.5	2

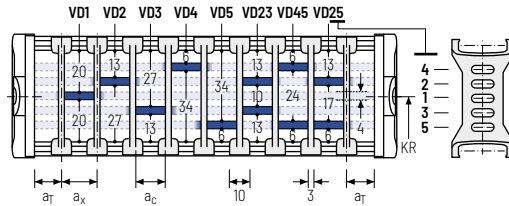

* not for design Q20

Divider system TS3 with height separation consisting of plastic section subdivisions

Vers.	a _T min [mm]	a _x min [mm]	a _c min [mm]	η _T min
A	4	16/40*	8	2

* for aluminium partitions

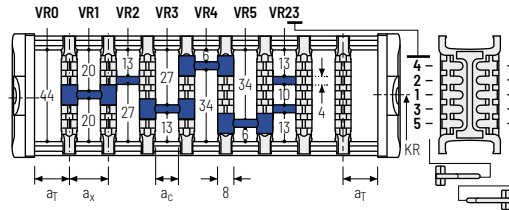

The dividers are fixed with the partitions. The entire divider system can be moved in the cross section.

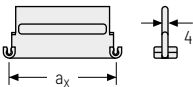

Aluminium partitions in 1 mm increments with a_x > 42 mm are also available.

a _x (centre distance of dividers) [mm]											
a _c (usable width of inner chamber) [mm]											
16	18	23	28	32	33	38	43	48	58	64	68
8	10	15	20	24	25	30	35	40	50	56	60
78	80	88	96	112	128	144	160	176	192	208	
70	72	80	88	104	120	136	152	168	184	200	

When using partitions with a_x > 112 mm, we recommend an additional central support with a **twin divider**. The height separations VD4 and VD5 are not possible when using twin dividers.

Cable carrier

Cable carrier configuration

Configuration guidelines

Materials information

MONO series

QuickTrax® series

UNIFLEX Advanced series

TKP35 series

TKK series

EasyTrax® series

Universal end connectors UMB – plastic (standard)

The universal mounting brackets (UMB) are made from plastic and can be mounted **from above, from below or on the face side**.

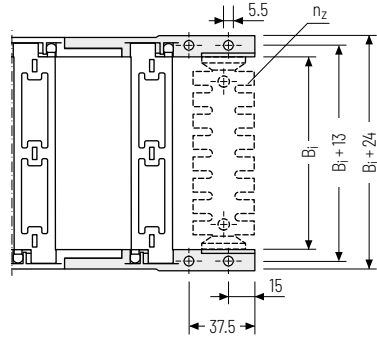
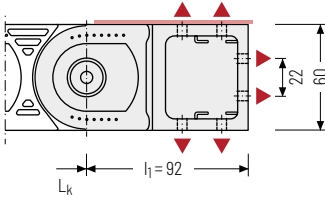

▲ Assembly options

 Recommended tightening torque:
5 Nm for screws M5 - 8.8

B_1 [mm]	n_2
50	2 x 3
75	2 x 5
100	2 x 7
125	2 x 9
150	2 x 11
175	2 x 13

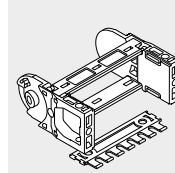

The end connectors are also available as an option **with** strain relief comb or **with** C-rail Art. no 3931 (1 on each side) for clamps. Please state when ordering.

UNIFLEX
Advanced
series

TKP35
series

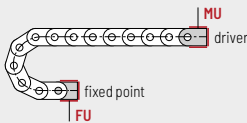

Connection point
F – fixed point
M – driver

Connection type
U – Universal mounting bracket

TKK
series

Order example



UMB	F	U
UMB	M	U
End connector	Connection point	Connection type



We recommend the use of strain reliefs at the driver and fixed point. See from p. 904.

EasyTrax®
series

Single-part end connectors – plastic

The plastic end connectors can be connected **from above or below**. The connection type can be changed by altering the position of the end connector.

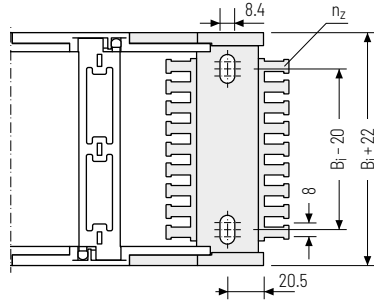
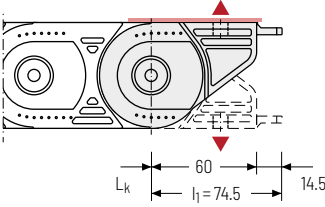

▲ Assembly options

 Recommended tightening torque:
15 Nm for screws M8 - 8.8

B_i [mm]	n_z
50	2 x 4
75	2 x 6
100	2 x 8
125	2 x 10
150	2 x 12
175	2 x 14
200	2 x 16
225	2 x 18
250	2 x 20

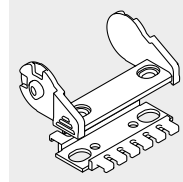

The end connectors are optionally also available **without** strain relief comb. Please state when ordering.

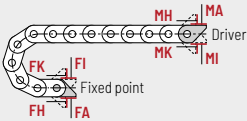

Connection point

F - fixed point
M - driver

Connection type

A - threaded joint outside (standard)
I - threaded joint inside
H - threaded joint, rotated 90° to the outside
K - threaded joint, rotated 90° to the inside

Order example

 End connector . F A
End connector . M A
End connector Connection point Connection type

Cable carrier

Cable carrier configuration

Configuration guidelines

Materials information

MONO series

QuickTrax® series

UNIFLEX Advanced series

TKP35 series

TKK series

EasyTrax® series

UA1775



Pitch
77.5 mm



Inner height
56 mm



Inner widths
100 – 400 mm



Bending radii
90 – 340 mm

Stay variants



Design 020 page **196**

Closed frame

- » Weight-optimised, closed plastic frame with particularly high torsional rigidity.
- » **Outside/inside:** not openable.



Design 030 page **197**

Frame with outside detachable stays

- » Weight-optimised plastic frame with particularly high torsional rigidity.
- » **Outside:** openable and detachable.



Design 040 page **198**

Frame with inside detachable stays

- » Weight-optimised plastic frame with particularly high torsional rigidity.
- » **Inside:** openable and detachable.

Cable carrier

Cable carrier configuration

Configuration guidelines

Materials information

MONO series

QuickTrax® series

UNIFLEX
Advanced series

TKP35 series

TKK series

EasyTrax® series

Unsupported arrangement

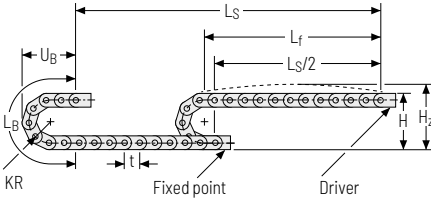





KR [mm]	H [mm]	H _z [mm]	L _B [mm]	U _B [mm]
90	257	297	438	206
115	307	347	516	231
140	357	397	595	256
165	407	447	673	281
190	457	497	752	306
240	557	597	909	356
285	647	687	1050	401
340	757	797	1223	456

Load diagram for unsupported length depending on the additional load.

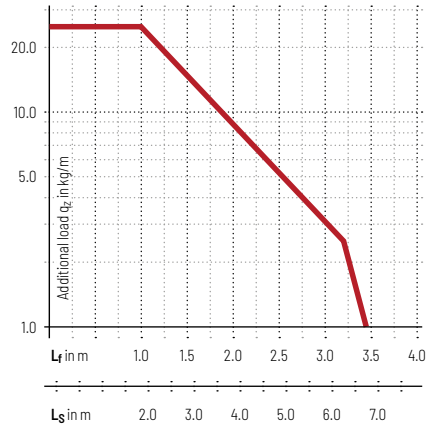
Sagging of the cable carrier is technically permitted for extended travel lengths, depending on the specific application.

Intrinsic cable carrier weight $q_k = 3.03 \text{ kg/m}$ with $B_i 150 \text{ mm}$. For other inner widths, the maximum additional load changes.





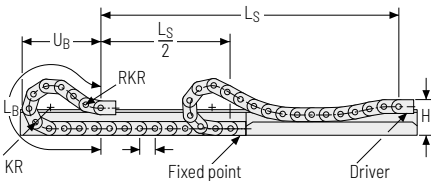

-  **Speed**
up to 10 m/s
-  **Acceleration**
up to 35 m/s²
-  **Travel length**
up to 7.8 m
-  **Additional load**
up to 25 kg/m

Gliding arrangement | GO module with chain links optimized for gliding



KR [mm]	H [mm]	GO-Modul RKR [mm]	L _B [mm]	U _B [mm]
90	231	400	1313	643
115	231	400	1440	688
140	231	400	1575	733
165	231	400	1715	779
190	231	400	1868	828
240	231	400	2225	951
285	231	400	2580	1081
340	231	400	3015	1240

-  **Speed**
up to 3 m/s
-  **Acceleration**
up to 8 m/s²
-  **Travel length**
up to 200 m
-  **Additional load**
up to 25 kg/m

 The gliding cable carrier must be guided in a channel. See p. 844.

The GO module mounted on the driver is a defined sequence of 5 adapted KR/RKR link plates.

Glide shoes must be used for gliding applications.

Cable carrier
Cable carrier configuration
Configuration guidelines
Materials information
MONO series
QuickTrax® series
UNIFLEX Advanced series
TKP35 series
TKK series
EasyTrax® series

Stay variant 020 – closed frame

- » Weight-optimised, closed plastic frame with particularly high torsional rigidity.
- » **Outside/inside:** not openable.



Stay arrangement on each chain link (**VS: fully-stayed**)



B_i : 100 - 400 mm

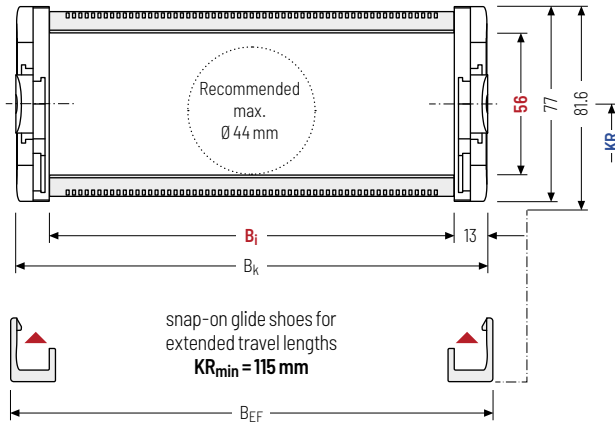

The maximum cable diameter strongly depends on the bending radius and the desired cable type. Please contact us.

Calculating the cable carrier length

Cable carrier length L_k

$$L_k \approx \frac{L_S}{2} + L_B$$

Cable carrier length L_k
rounded to pitch t

h_1 [mm]	h_G [mm]	$h_{G'}$ [mm]	B_i [mm]				B_k [mm]	B_{EF} [mm]	KR [mm]			q_k [kg/m]
56	77	81.6	100	125	150	175	$B_i + 26$	$B_i + 30$	90	115	140	2.844 - 4.239
			200	225	250	275			165	190	240	
			300	325	350	400			285	340		

Order example



UA1775

Type

020

Stay variant

150

B_i [mm]

140

KR [mm]

3100

L_k [mm]

VS

Stay arrangement

Stay variant 030 – with outside opening and detachable stays

- » Weight-optimised plastic frame with particularly high torsional rigidity.
- » Swivable and detachable left or right in any position.
- » **Outside:** openable and detachable.

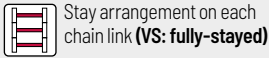

Stay arrangement on each chain link (VS: fully-stayed)



B_i 100 – 400 mm

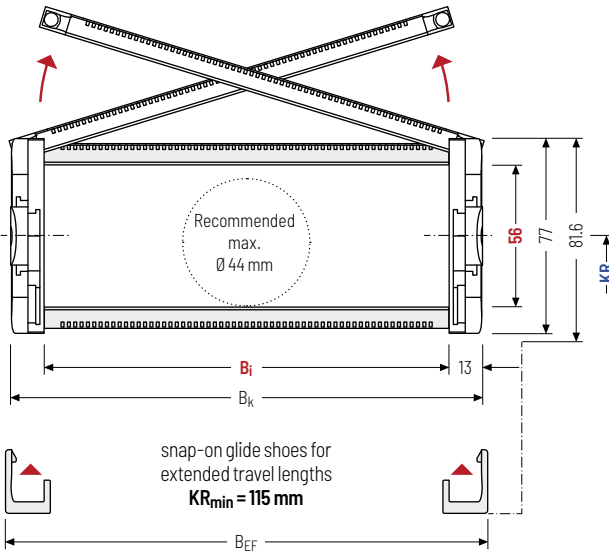

The maximum cable diameter strongly depends on the bending radius and the desired cable type. Please contact us.

Calculating the cable carrier length

Cable carrier length L_k

$$L_k \approx \frac{L_S}{2} + L_B$$

Cable carrier length L_k rounded to pitch t

h_i [mm]	h_G [mm]	h_G' [mm]	B_i [mm]				B_k [mm]	B_{EF} [mm]	KR [mm]			q_k [kg/m]
56	77	81.6	100	125	150	175	$B_i + 26$	$B_i + 30$	90	115	140	2.831 – 4.224
			200	225	250	275			165	190	240	
			300	325	350	400			285	340		

Order example

UA1775
030
150
140
3100
VS

Type Stay variant B_i [mm] KR [mm] L_k [mm] Stay arrangement

Stay variant 040 – with inside opening and detachable stays

- » Weight-optimised plastic frame with particularly high torsional rigidity.
- » Swivable and detachable left or right in any position.
- » **Inside:** openable and detachable.



Stay arrangement on each chain link (**VS: fully-stayed**)



B_i : 100 - 400 mm

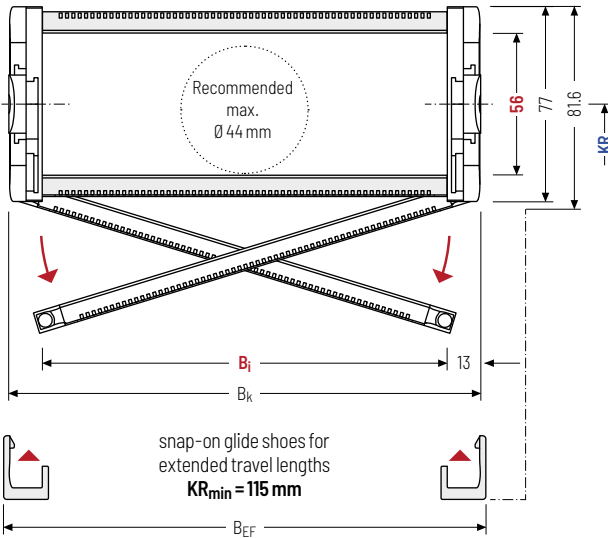

The maximum cable diameter strongly depends on the bending radius and the desired cable type. Please contact us.

Design 040 is not suitable for a gliding arrangements without the use of gliding shoes.

Calculating the cable carrier length

Cable carrier length L_k

$$L_k \approx \frac{L_S}{2} + L_B$$

Cable carrier length L_k rounded to pitch t

h_i [mm]	h_G [mm]	h_G' [mm]	B_i [mm]				B_k [mm]	B_{EF} [mm]	KR [mm]			q_k [kg/m]
56	77	81.6	100	125	150	175	$B_i + 26$	$B_i + 30$	90	115	140	2.831 - 4.224
			200	225	250	275			165	190	240	
			300	325	350	400			285	340		

Order example



UA1775

Type

040

Stay variant

150

B_i [mm]

140

KR [mm]

3100

L_k [mm]

VS

Stay arrangement

Divider systems

The divider system is mounted on every 2nd chain link as a standard.

For applications with lateral acceleration and lying on the side, divider with arresting cams are available.

As a standard, dividers or the complete divider system (dividers with height separations) are movable in the cross section (**version A**).

The locking cams click into place in the locking grids in the stays (**version B**).

Divider system TSO without height separation

Vers.	a _T min [mm]	a _x min [mm]	a _c min [mm]	a _x grid [mm]	n _T min
A	5	10	7	-	-
B	5	10	7	2.5	-

Number of dividers for design Q20 depending on B_i

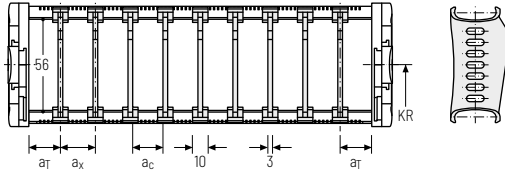

Divider system TS1 with continuous height separation*

Vers.	a _T min [mm]	a _x min [mm]	a _c min [mm]	a _x grid [mm]	n _T min
A	5	10	7	-	2
B	5	10	7	2.5	2

* not for design Q20

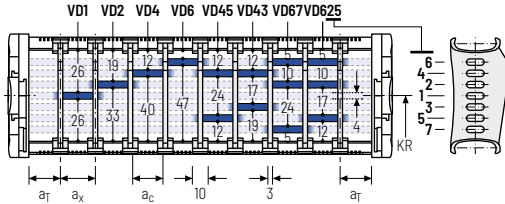

Order example

TS1

·

A

·

3

-

VD0

⋮

VD1

Divider system
Version
n_T
Height separation

Please state the designation of the divider system (**TS0, TS1,...**), the version, and the number of dividers per cross section [n_T].

When using divider systems with height separation (**TS1**), please additionally state the position (e.g. VD1) viewed from the left driver belt. You are welcome to add a sketch to your order.

Cable carrier
Cable carrier configuration
Configuration guidelines
Materials information
MOMO series
QuickTrax® series
UNIFLEX Advanced series
TKP35 series
TKK series
EasyTrax® series

Divider system TS3 with height separation consisting of plastic partitions

As a standard, the divider **version A** is used for vertical partitioning within the cable carrier. The complete divider system can be moved within the cross section.

Cable carrier

Cable carrier configuration

Configuration guidelines

Materials information

MONO series

QuickTrax® series

UNIFLEX Advanced series

TKP35 series

TKK series

EasyTrax® series

Divider version A

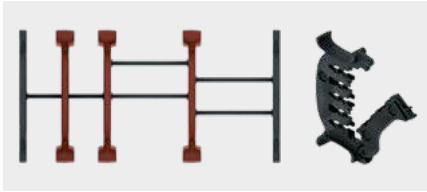

End divider

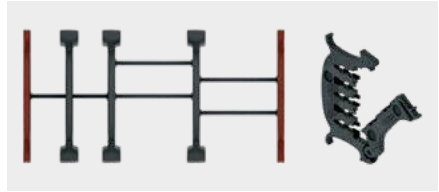

Vers.	a_T min [mm]	a_x min [mm]	a_c min [mm]	n_T min
A	5 / 2*	14	10	2

* For End divider

The dividers are fixed by the partitions, the complete divider system is movable in the cross section.

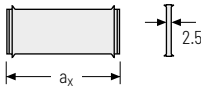
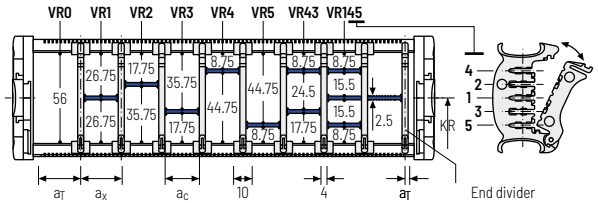

a_x (center distance of dividers) [mm]																
a_c (nominal width of inner chamber) [mm]																
14	16	19	23	24	28	29	32	33	34	38	39	43	44	48	49	54
10	12	15	19	20	24	25	28	29	30	34	35	39	40	44	45	50
58	59	64	68	69	74	78	79	80	84	88	89	94	96	99	112	
54	55	60	64	65	70	74	75	76	80	84	85	90	92	95	108	

When using **partitions with $a_x > 49$ mm** we recommended an additional preferential central support.

Order example

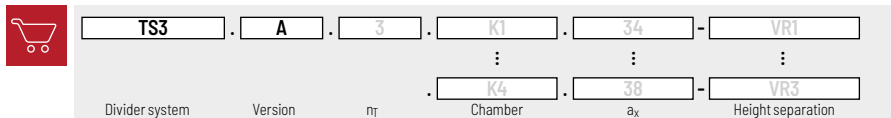

Please state the designation of the divider system (**TS0, TS1,...**), version and number of dividers per cross section [n_T]. In addition, please also enter the chambers [K] from left to right, as well as the assembly distances [a_T/a_x] (as seen from the driver).

If using divider systems with height separation (**TS1, TS3**) please also state the positions [e.g. VD23] viewed from the left driver belt. You are welcome to add a sketch to your order.

Universal end connectors UMB – plastic (standard)

The universal mounting brackets (UMB) are made from plastic and can be mounted **from above, from below or on the face side**.

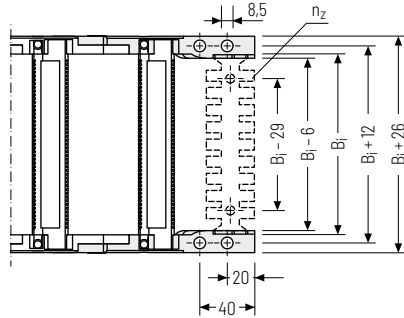
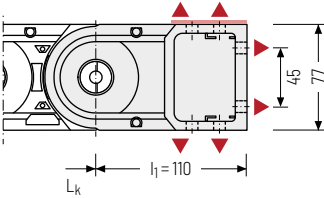

▲ Assembly options

Recommended tightening torque:
27 Nm for screws M8

B_i [mm]	n_z
100	2 x 7
125	2 x 9
150	2 x 11
175	2 x 13

The end connectors are also available as an option **with** strain relief comb or **with** C-rail Art. no 3931 (1 on each side) for clamps. Please state when ordering.

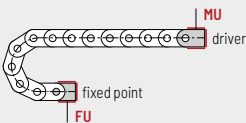

Connection point
F - fixed point
M - driver

Connection type
U - Universal mounting bracket

Order example

	UMB	.	F	U
	UMB	.	M	U
	End connector		Connection point	Connection type

We recommend the use of strain reliefs at the driver and fixed point. See from p. 904.

Cable carrier

Cable carrier configuration

Configuration guidelines

Materials information

MONO series

QuickTrax® series

UNIFLEX Advanced series

TKP35 series

TKK series

EasyTrax® series

UA1995



Pitch
99.5 mm



Inner height
80 mm



Inner widths
85 – 250 mm



Bending radii
150 – 500 mm

Stay variants



Design 020 page **204**

Closed frame

- » Weight-optimised, closed plastic frame with particularly high torsional rigidity.
- » **Outside/inside:** not openable.



Design 030 page **205**

Frame with outside detachable stays

- » Weight-optimised plastic frame with particularly high torsional rigidity.
- » **Outside:** release by rotating 90°.



Design 040 page **206**

Frame with inside detachable stays

- » Weight-optimised plastic frame with particularly high torsional rigidity.
- » **Inside:** release by rotating 90°.



Design 070 page **207**

Frame with outside and inside detachable stays

- » Weight-optimised plastic frame with particularly high torsional rigidity.
- » **Outside/inside:** release by rotating 90°.

Unsupported arrangement

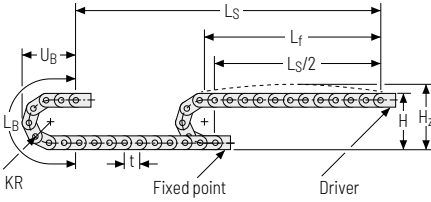

KR [mm]	H [mm]	H ₂ [mm]	L _B [mm]	U _B [mm]
150	410	440	680	250
210	530	560	860	310
250	610	640	990	350
300	710	740	1150	400
350	810	840	1300	450
400	910	940	1460	500
500	1110	1140	1770	600

Load diagram for unsupported length depending on the additional load.

Sagging of the cable carrier is technically permitted for extended travel lengths, depending on the specific application.

Intrinsic cable carrier weight $q_k = 3.85 \text{ kg/m}$ with B_i 196 mm. For other inner widths, the maximum additional load changes.

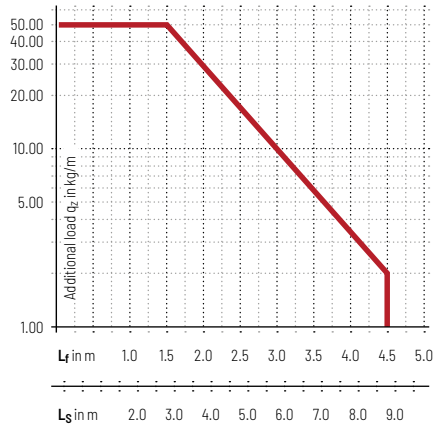

- Speed**
up to 10 m/s
- Acceleration**
up to 25 m/s²
- Travel length**
up to 9 m
- Additional load**
up to 50 kg/m

Cable carrier

Cable carrier configuration

Configuration guidelines

Materials information

MONO series

QuickTrax® series

Gliding arrangement | GO module with chain links optimized for gliding*

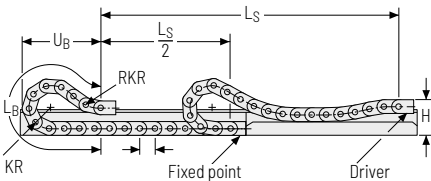

KR [mm]	H [mm]	GO-Modul RKR [mm]	L _B [mm]	U _B [mm]
150	330	400	1805	890
210	330	400	2180	1010
250	330	400	2390	1070
300	330	400	2690	1160
350	330	400	3090	1310
400	330	400	3490	1450
500	330	400	4280	1740

- Speed**
up to 8 m/s
- Acceleration**
up to 20 m/s²
- Travel length**
up to 200 m
- Additional load**
up to 50 kg/m

The gliding cable carrier must be guided in a channel. See p. 844.

The GO module mounted on the driver is a defined sequence of 5 adapted KR/RKR link plates.

Glide shoes must be used for gliding applications.

UNIFLEX Advanced series

TKP35 series

TKK series

EasyTrax® series

* only design 070

Stay variant 020 – closed frame

- » Weight-optimised, closed plastic frame with particularly high torsional rigidity.
- » **Outside/inside:** not openable.



Stay arrangement on each chain link (**VS: fully-stayed**)



B_i : 85 – 250 mm

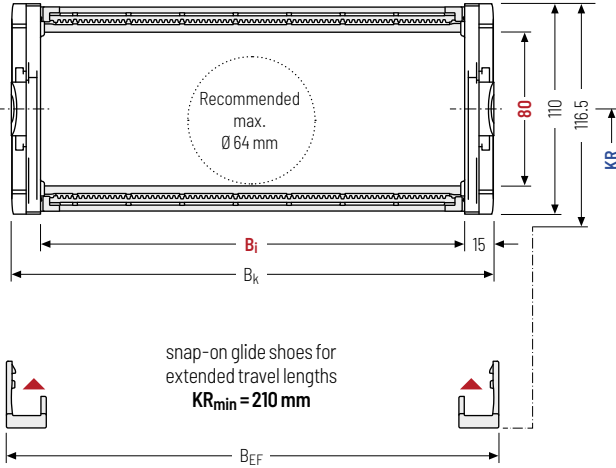

The maximum cable diameter strongly depends on the bending radius and the desired cable type. Please contact us.

Calculating the cable carrier length

Cable carrier length L_k

$$L_k \approx \frac{L_S}{2} + L_B$$

Cable carrier length L_k rounded to pitch t

h_i [mm]	h_g [mm]	h_g' [mm]	B_i [mm]				B_k [mm]	B_{EF} [mm]	KR [mm]				q_k [kg/m]
80	110	116.5	85	125	138	150	$B_i + 30$	$B_i + 36$	150	210	250	300	3.860 – 3.861
			180	196	225	250			350	400	500		

Order example

UA1995
Type
·
020
Stay variant
·
150
 B_i [mm]
·
210
 KR [mm]
·
3582
 L_k [mm]
·
VS
Stay arrangement

Stay variant 030 – with outside detachable stays

- » Weight-optimised plastic frame with particularly high torsional rigidity.
- » **Outside:** release by rotating 90°.



Stay arrangement on each chain link (VS: fully-stayed)



B_i 85 – 250 mm

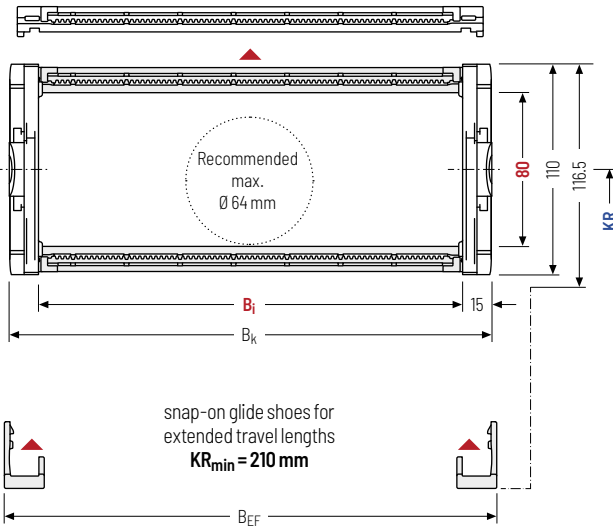

The maximum cable diameter strongly depends on the bending radius and the desired cable type. Please contact us.

Calculating the cable carrier length

Cable carrier length L_k

$$L_k \approx \frac{L_S}{2} + L_B$$

Cable carrier length L_k rounded to pitch t

h_i [mm]	h_G [mm]	h_G' [mm]	B_i [mm]				B_k [mm]	B_{EF} [mm]	KR [mm]				q_k [kg/m]
80	110	116.5	85	125	138	150	$B_i + 30$	$B_i + 36$	150	210	250	300	3.833 – 3.834
			180	196	225	250			350	400	500		

Order example

UA1995
Type
·
030
Stay variant
·
150
B_i [mm]
·
210
KR [mm]
·
3582
L_k [mm]
·
VS
Stay arrangement

Stay variant 040 – with inside detachable stays

- » Weight-optimised plastic frame with particularly high torsional rigidity.
- » **Inside:** release by rotating 90°.



Stay arrangement on each chain link (**VS: fully-stayed**)



B_i : 85 - 250 mm

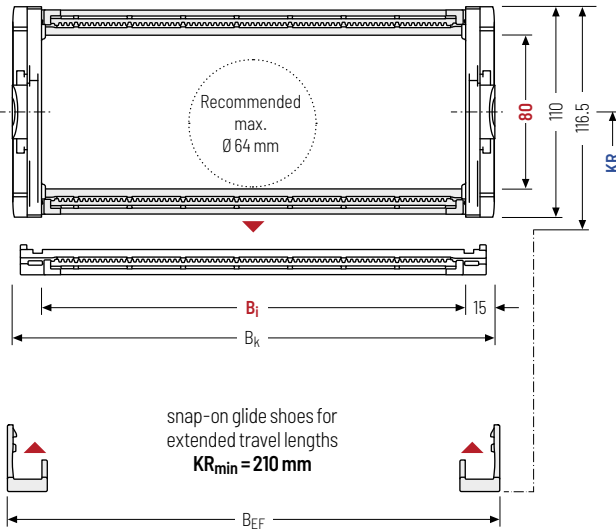

The maximum cable diameter strongly depends on the bending radius and the desired cable type. Please contact us.

Design 040 is not suitable for a gliding arrangements without the use of gliding shoes.

Calculating the cable carrier length

Cable carrier length L_k

$$L_k \approx \frac{L_S}{2} + L_B$$

Cable carrier length L_k rounded to pitch t

h_i [mm]	h_g [mm]	h_g' [mm]	B_i [mm]				B_k [mm]	B_{EF} [mm]	KR [mm]				q_k [kg/m]
80	110	116.5	85	125	138	150	$B_i + 30$	$B_i + 36$	150	210	250	300	3.833 - 3.834
			180	196	225	250			350	400	500		

Order example



UA1995

Type

040

Stay variant

150

B_i [mm]

210

KR [mm]

3582

L_k [mm]

VS

Stay arrangement

Stay variant 070 – with outside and inside detachable stays

- » Weight-optimised plastic frame with particularly high torsional rigidity.
- » **Outside/Inside:** release by rotating 90°.



 Stay arrangement on each chain link (**VS: fully-stayed**)

 B_i 85 – 250 mm

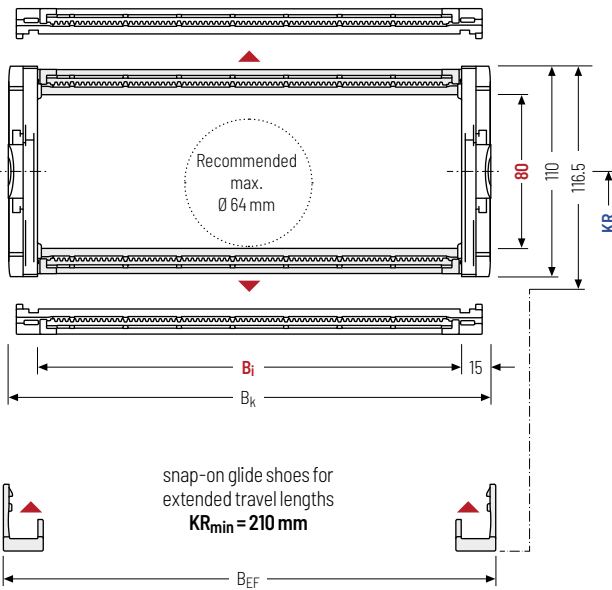

 The maximum cable diameter strongly depends on the bending radius and the desired cable type. Please contact us.

 Design 070 is not suitable for a gliding arrangements without the use of gliding shoes.

Calculating the cable carrier length

Cable carrier length L_k

$$L_k \approx \frac{L_S}{2} + L_B$$

Cable carrier length L_k rounded to pitch t

h _i [mm]	h _g [mm]	h _{g'} [mm]	B _i [mm]				B _k [mm]	B _{EF} [mm]	KR [mm]				q _k [kg/m]
80	110	116.5	85	125	138	150	B _i + 30	B _i + 36	150	210	250	300	3.852 – 3.853
			180	196	225	250			350	400	500		

Order example

 UA1995 · 070 · 150 · 210 · 3582 · VS

Type Stay variant B_i [mm] KR [mm] L_k [mm] Stay arrangement

- Cable carrier
- Cable carrier configuration
- Configuration guidelines
- Materials information
- MONO series
- QuickTrax® series
- UNIFLEX Advanced series
- TKP35 series
- TKK series
- EasyTrax® series

Divider systems

The divider system is mounted on every 2nd chain link as a standard.

As a standard, dividers or the complete divider system (dividers with height separations) are movable in the cross section (**version A**).

For applications with lateral acceleration and lying on the side, divider with arresting cams are available.

The locking cams click into place in the locking grids in the stays (**version B**).

Divider system TSO without height separation

Vers.	a _T min [mm]	a _x min [mm]	a _c min [mm]	a _x grid [mm]	n _T min
A	10	16	12	-	-
B	10	17.5	13.5	2.5	-

Number of dividers for design 020 depending on B₁

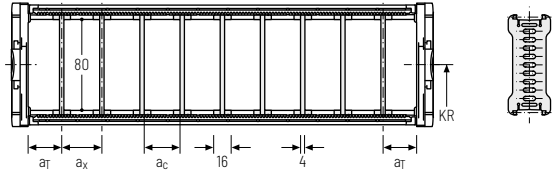

Divider system TS1 with continuous height separation*

Vers.	a _T min [mm]	a _x min [mm]	a _c min [mm]	a _x grid [mm]	n _T min
A	10	16	12	-	2
B	10	17.5	13.5	2.5	2

* not for design 020

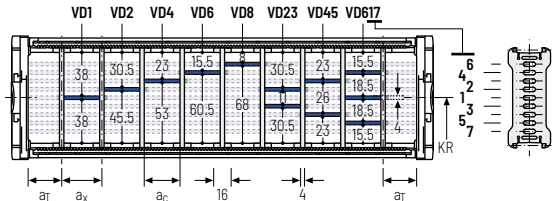

Order example



· · ·
 :

Divider system Version n_T Height separation

Please state the designation of the divider system (**TS0, TS1,...**), the version, and the number of dividers per cross section [n_T].

When using divider systems with height separation (**TS1**), please additionally state the position (e.g. VD1) viewed from the left driver belt. You are welcome to add a sketch to your order.

Divider system TS3 with height separation consisting of plastic partitions

As a standard, the divider **version A** is used for vertical partitioning within the cable carrier. The complete divider system can be moved within the cross section.

Divider version A

End divider



Vers.	a _T min [mm]	a _x min [mm]	a _c min [mm]	n _T min
A	8 / 4*	14	10	2

Number of dividers for design D20 depending on B;
* For End divider

The dividers are fixed by the partitions, the complete divider system is movable in the cross section.

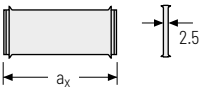
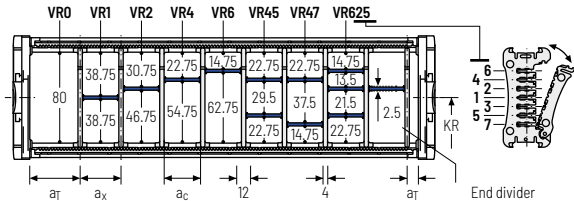

a _x (center distance of dividers) [mm]																
a _c (nominal width of inner chamber) [mm]																
14	16	19	23	24	28	29	32	33	34	38	39	43	44	48	49	54
10	12	15	19	20	24	25	28	29	30	34	35	39	40	44	45	50
58	59	64	68	69	74	78	79	80	84	88	89	94	96	99	112	
54	55	60	64	65	70	74	75	76	80	84	85	90	92	95	108	

An additional central support is required when using plastic partitions with a_x > 49 mm.

Order example

🛒

TS3

A

3

K1

34

VR1

⋮

⋮

⋮

K4

38

VR3

Divider system Version n_T Chamber a_x Height separation

Please state the designation of the divider system (**TS0, TS1,...**), version and number of dividers per cross section [n_T]. In addition, please also enter the chambers [K] from left to right, as well as the assembly distances [a_T/a_x] (as seen from the driver).

If using divider systems with height separation (**TS1, TS3**) please also state the positions [e.g. VD23] viewed from the left driver belt. You are welcome to add a sketch to your order.

- Cable carrier
- Cable carrier configuration
- Configuration guidelines
- Materials information
- MONO series
- QuickTrax® series
- UNIFLEX Advanced series
- TKP35 series
- TKK series
- EasyTrax® series

EasyTrax®
seriesTKK
seriesTKP35
seriesUNIFLEX
Advanced
seriesQuickTrax®
seriesMONO
seriesMaterials
informationConfiguration
guidelinesCable carrier
configuration

Cable carrier

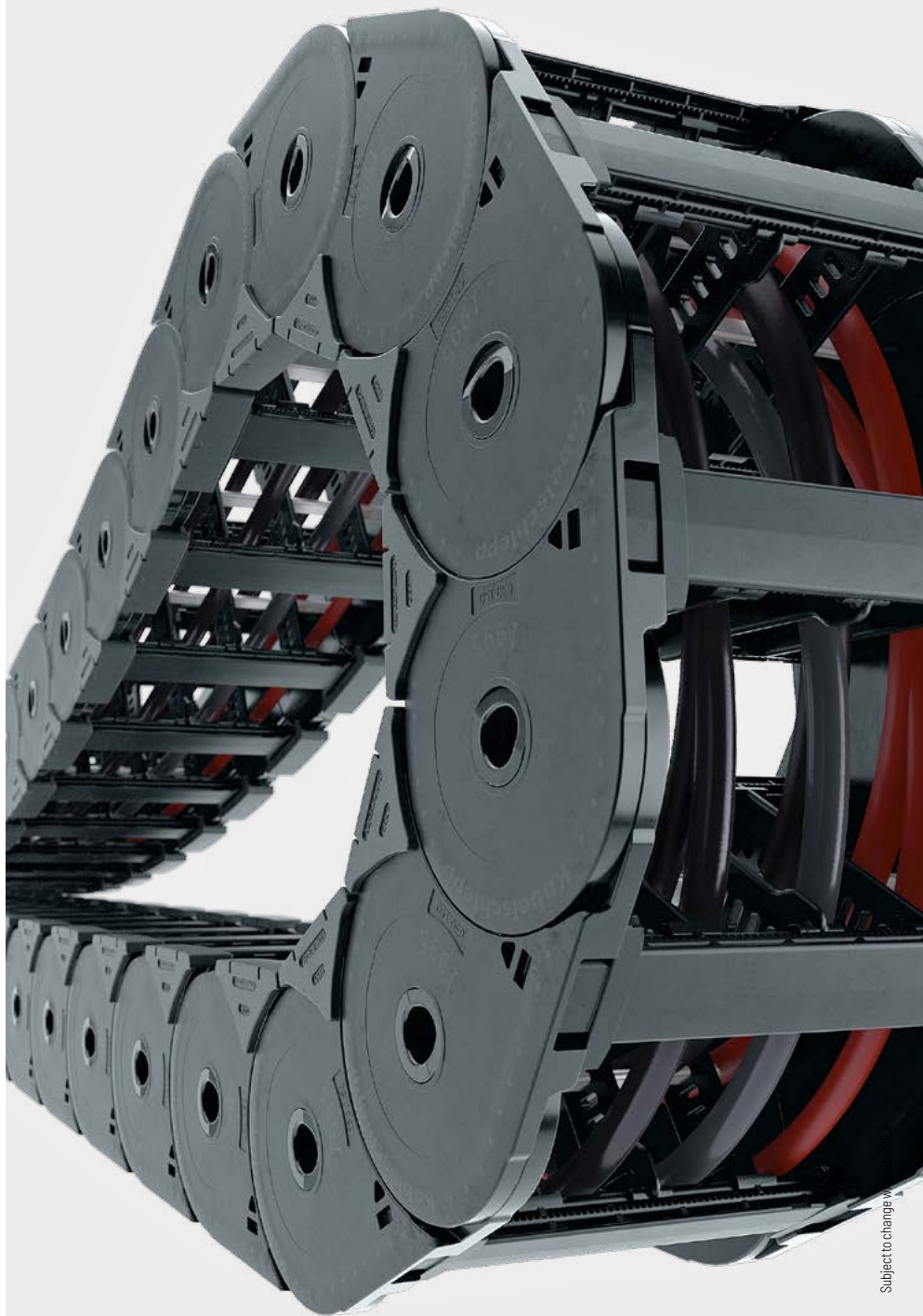

Universal end connectors UMB – plastic (standard)

The universal mounting brackets (UMB) are made from plastic and can be mounted **from above, from below or on the face side**.

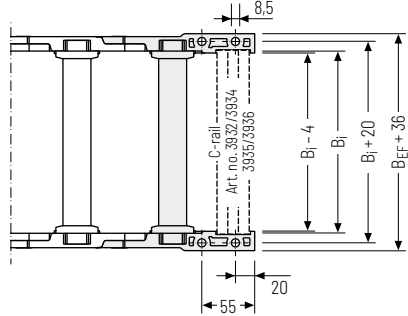
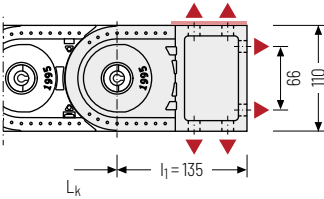

▲ Assembly options

Recommended tightening torque:
27 Nm for screws M8

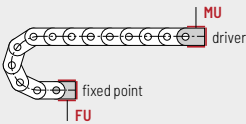

Connection point
F - fixed point
M - driver

Connection type
U - Universal mounting bracket

Order example

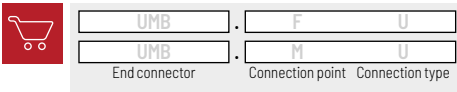

We recommend the use of strain reliefs at the driver and fixed point. See from p. 904.

Cable carrier

Cable carrier configuration

Configuration guidelines

Materials information

MONO series

QuickTrax® series

UNIFLEX Advanced series

TKP35 series

TKK series

EasyTrax® series

Additional product information online



Installation instructions, etc.:
Additional info via your smartphone or check online at tsubaki-kabelschlepp.com/downloads



Configure your cable carrier here:
online-engineer.de

TKP35 series

Robust all-rounder
with variable inner distribution



Trademarks are legally protected for the TSUBAKI KABELSCHLEPP GmbH
as a national or international registration in the following countries:
tsubaki-kabelschlepp.com/trademarks

Subject to change without notice.

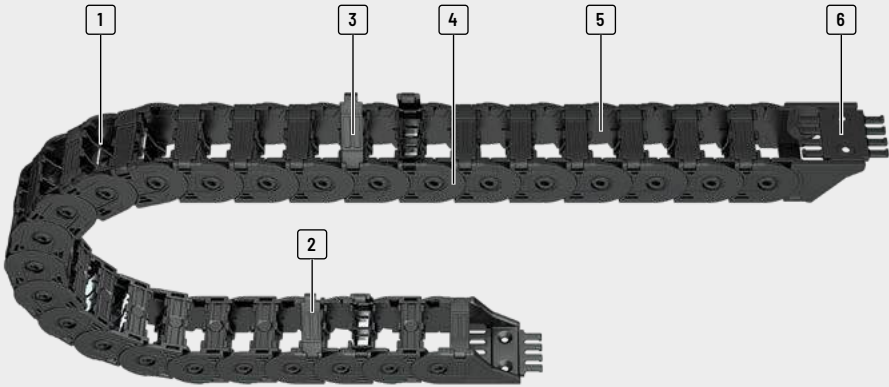

- 1 Dividers and height partitions for cable separation
- 2 Designs with inward or outward opening cross-bars
- 3 Easy and quick to open at any position
- 4 Integrated noise damping
- 5 Interior space is gentle on the cables without sharp edges
- 6 End connectors with optional strain relief

Features

- » Robust and extremely rigid stroke system
- » Quiet operation due to internal dampening system
- » Weight-optimized cable carrier geometry
- » Interior without sharp edges, design that protects the cable
- » Variable inner distribution
- » Vertical moveable dividers or with arresting cams, can be attached at 2-mm increments (not B; 16)
- » Easy-to-open versions, left or right (not B; 16)
- » Quick and easy to open
- » Optional strain relief can be fully integrated into the end connector



Reliable cable separation through fixable dividers



Design 030 with outside opening and detachable crossbars on both sides



Design 040 with inside opening and detachable crossbars on both sides



Optimised utilisation of the interior space; vertical and horizontal inner distribution possible

Cable carrier

Cable carrier configuration

Configuration guidelines

Materials information

MONO series

QuickTrax® series

UNIFLEX Advanced series

TKP35 series

TKK series

EasyTrax® series

Type	Opening variant	Stay variant	h_i [mm]	h_G [mm]	B_i [mm]	B_k [mm]	B_i - grid [mm]	t [mm]	KR [mm]	Additional load \leq [kg/m]	Cable- d_{max} [mm]
TKP35											
		030	32	40	16 - 50	26 - 62	-	35	48 - 125	2	25
		040	32	40	25 - 50	37 - 62	-	35	48 - 125	2	25

EasyTrax®
seriesTKK
seriesTKP35
seriesUNIFLEX
Advanced
seriesQuickTrax®
seriesMONO
seriesMaterials
informationConfiguration
guidelinesCable carrier
configuration

Cable carrier

Unsupported arrangement			Gliding arrangement			Inner Distribution				Movement			Page
Travel length ≤ [m]	v_{max} ≤ [m/s]	a_{max} ≤ [m/s ²]	Travel length ≤ [m]	v_{max} ≤ [m/s]	a_{max} ≤ [m/s ²]	TS0	TS1	TS2	TS3	vertical hanging or standing	lying on the side	rotating arrangement	
										vertical hanging or standing	lying on the side	rotating arrangement	
2.3	5	20	-	-	-	•	•	-	-	•	•	•	218
2.3	5	20	-	-	-	•	•	-	-	•	•	•	219

Cable carrier

Cable carrier configuration

Configuration guidelines

Materials information

MONO series

QuickTrax® series

UNIFLEX Advanced series

TKP35 series

TKK series

EasyTrax® series

TKP35

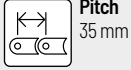

Pitch
35 mm



Inner height
32 mm



Inner widths
16 – 50 mm



Bending radii
48 – 125 mm

Stay variants



Design 030 page 218

Frame with outside opening crossbars on both sides

- » Weight-optimised plastic frame with particularly high torsional rigidity.
- » Can be opened at any position on both sides.
- » **Outside:** opening and detachable crossbars.



Design 040 page 219

Frame with inside opening crossbars on both sides

- » Weight optimised plastic frame with high torsional rigidity.
- » Can be opened at any position on both sides.
- » **Inside:** opening and detachable crossbars.

Cable carrier

Cable carrier configuration

Configuration guidelines

Materials information

MONO series

QuickTrax® series

UNIFLEX Advanced series

TKP35 series

TKK series

EasyTrax® series

Unsupported arrangement

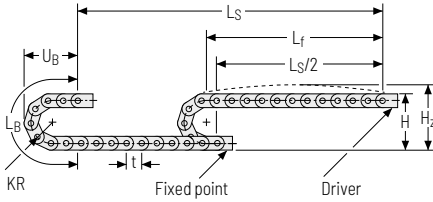

KR [mm]	H [mm]	H _z [mm]	L _B [mm]	U _B [mm]
48	146	176	220	103
60	170	200	258	115
75	200	230	306	130
100	250	280	384	155
125	300	330	463	180

Load diagram for unsupported length depending on the additional load.

Sagging of the cable carrier is technically permitted for extended travel lengths, depending on the specific application.

Intrinsic cable carrier weight $q_k = 0.5 \text{ kg/m}$ with $B_3 16 \text{ mm}$. For other inner widths, the maximum additional load changes.

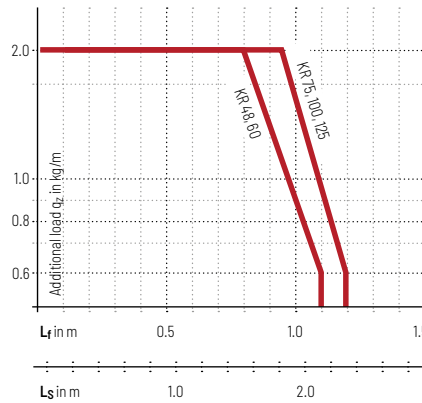

Speed
up to 5 m/s

Acceleration
up to 20 m/s²

Travel length
up to 2.3 m

Additional load
up to 2 kg/m

- Cable carrier
- Cable carrier configuration
- Configuration guidelines
- Materials information
- MONO series
- QuickTrax® series
- UNIFLEX Advanced series
- TKP35 series
- TKK series
- EasyTrax® series

TRAXLINE® cables for cable carriers
Hi-flex electric cables which were specially developed, optimised and tested for use in cable carriers can be found at tsubaki-kabelschlepp.com/traxline.

Additional product information online

Installation instructions, etc.
Additional info via your smartphone or check online at tsubaki-kabelschlepp.com/downloads

Configure your cable carrier here:
online-engineer.de

Stay variant 030 – with outside opening and detachable crossbars

- » Weight-optimised plastic frame with particularly high torsional rigidity.
- » Can be opened at any position on both sides.
- » **Outside:** opening and detachable crossbars.



Stay arrangement on each chain link (**VS: fully-stayed**)



B_i 16 – 50 mm

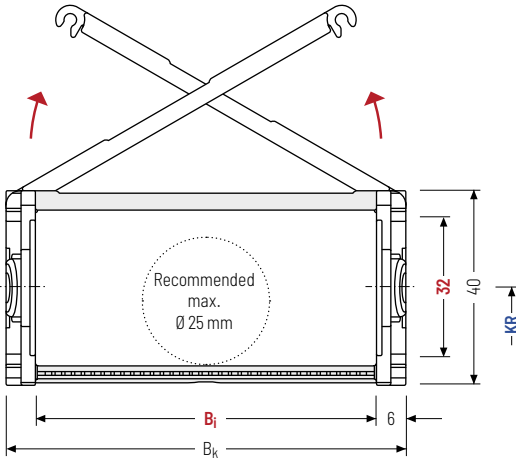

The maximum cable diameter strongly depends on the bending radius and the desired cable type. Please contact us.

Calculating the cable carrier length

Cable carrier length L_k

$$L_k \approx \frac{L_S}{2} + L_B$$

Cable carrier length L_k rounded to pitch t

Cable carrier
Cable carrier configuration
Configuration guidelines
Materials information
MONO series
QuickTrax® series
UNIFLEX Advanced series
TKP35 series
TKK series
EasyTrax® series

h_i [mm]	h_g [mm]	B_i [mm]				B_k [mm]	KR [mm]					q_k [kg/m]
32	40	16	25	38	50	$B_i + 12^*$	48	60	75	100	125	0.5 – 0.8

*For B_i 16 = $B_i + 10$

Order example

TKP35
Type
·
030
Stay variant
·
50
 B_i [mm]
·
100
 KR [mm]
·
700
 L_k [mm]
·
VS
Stay arrangement

Stay variant 040 – with inside opening and detachable crossbars

- » Weight-optimised plastic frame with particularly high torsional rigidity.
- » Can be opened at any position on both sides.
- » **Inside:** opening and detachable crossbars.



Stay arrangement on each chain link (VS: fully-stayed)



B_i 25 – 50 mm

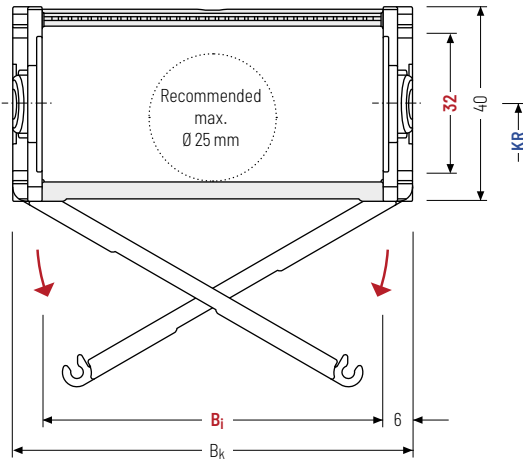

The maximum cable diameter strongly depends on the bending radius and the desired cable type. Please contact us.

Calculating the cable carrier length

Cable carrier length L_k

$$L_k \approx \frac{L_S}{2} + L_B$$

Cable carrier length L_k rounded to pitch t

h_i [mm]	h_G [mm]	B_i [mm]			B_k [mm]	KR [mm]					q_k [kg/m]
32	40	25	38	50	$B_i + 12$	48	60	75	100	125	0.6 – 0.8

Order example



TKP35 Type	·	040 Stay variant	·	50 B_i [mm]	·	100 KR [mm]	·	700 L_k [mm]	·	VS Stay arrangement
---------------	---	---------------------	---	------------------	---	------------------	---	-------------------	---	------------------------

Cable carrier

Cable carrier configuration

Configuration guidelines

Materials information

MONO series

QuickTrax® series

UNIFLEX Advanced series

TKP35 series

TKK series

EasyTrax® series

Divider systems

The divider system is mounted on every 2nd chain link as a standard.

As a standard, dividers or the complete divider system (dividers with height separations) are movable in the cross section (**version A**).

For applications with lateral accelerations and applications with the cable carrier rotated by 90°, the dividers can easily be fixed on the stay through rotation.

The arresting cams snap into the catch profiles in the covers (**version B**).

Divider system TSO without height separation

Vers.	a _T min [mm]	a _x min [mm]	a _c min [mm]	a _x grid [mm]	nr min
A	3	6	4	-	-
B	4.5* / 5	6	4	2	-

* Only B; 25

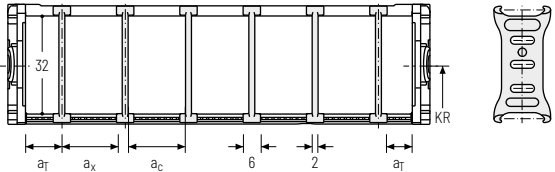

Divider system TS1 with continuous height separation

Vers.	a _T min [mm]	a _x min [mm]	a _c min [mm]	a _x grid [mm]	nr min
A	3	6	4	-	2
B	4.5* / 5	6	4	2	2

* Only B; 25

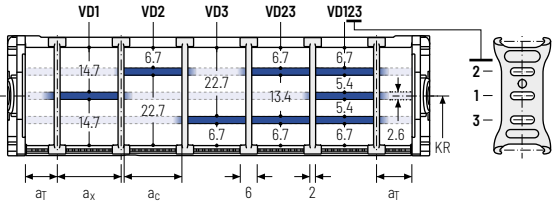

The dividers can be moved in the cross section.

Order example



TS1	.	A	.	3	-	VD1
						⋮
						VD3
Divider system		Version		nr		Height separation

Please state the designation of the divider system (**TS0, TS1,...**), the version, and the number of dividers per cross section [nr].

When using divider systems with height separation (TS1), please additionally state the position (e.g. VD1) viewed from the left driver belt. You are welcome to add a sketch to your order.

Single-part end connectors – plastic
(suitable for B_i 16)

The plastic end connectors can be **connected from above or below**. The connection type can be changed by altering the position of the end connector.

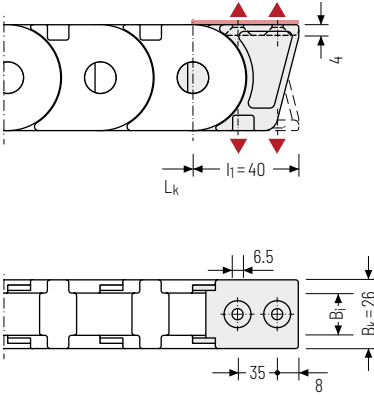

▲ Assembly options

Single-part end connectors – plastic
(suitable for B_i 25 – 50)

The plastic end connectors can be **connected from above or below**. The connection type can be changed by altering the position of the end connector.

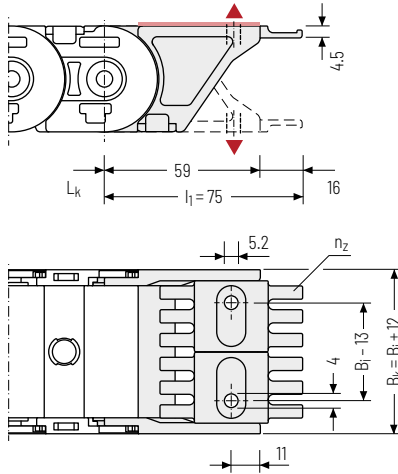

 The end connectors are optionally also available without strain relief comb.

B _i [mm]	B _{EF} [mm]	n _z
25	37	2
38	50	4
50	62	6

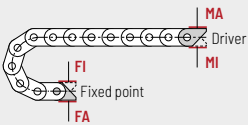

Connection point
F – fixed point
M – driver

Connection type
A – threaded joint outside (standard)
I – threaded joint inside

Order example

 End connector . F A
End connector . M A
End connector Connection point Connection type

Cable carrier
Cable carrier configuration
Configuration guidelines
Materials information
MONO series
QuickTrax® series
UNIFLEX Advanced series
TKP35 series
TKK series
EasyTrax® series

TKK series

Dirt-repellent cable carriers
made of plastic

Trademarks are legally protected for TSUBAKI KABELSCHLEPP GmbH as
a national or international registration in the following countries:
tsubaki-kabelschlepp.com/trademarks

Subject to change without notice.



- | | | | |
|---|--|--|--|
| <p>1 Very short steel end connectors</p> <p>2 Plastic chain links</p> | <p>3 Extensive unsupported length</p> <p>4 Link system repels dust and chips</p> | <p>5 Smooth surface for smooth running</p> <p>6 Inside openable (design 040)</p> | <p>7 Dividers and height separations for cable separation</p> |
|---|--|--|--|

Features

- | | |
|--|--|
| <ul style="list-style-type: none"> » High torsional rigidity » Optimised dividers to protect cables: rounded inner and outer profile » Extensive unsupported length » New dirt-resistant design of the chain links to protect against dust and chips » Smooth surface for optimum running » Closed and openable designs » Very short end connectors » Fixable dividers | <ul style="list-style-type: none"> » Optimised stroke system » High side stability » Space-saving design for small spaces |
|--|--|



Optimised divider design to protect cables



New design of chain links. Link system repels dust, chips and dirt



Very short end connectors

Cable carrier

Cable carrier configuration

Configuration guidelines

Materials information

MOND series

QuickTrax® series

UNIFLEX Advanced series

TKP35 series

TKK series

EasyTrax® series

Type	Opening variant	Stay variant	h_i [mm]	h_G [mm]	B_i [mm]	B_k [mm]	B_i - grid [mm]	t [mm]	KR [mm]	Additional load \leq [kg/m]	Cable- d_{max} [mm]
TKK39											
		020	39	50	39-99	60-120	-	39	46-95	10	31
		040	39	50	39-99	60-120	-	39	46-95	10	31

EasyTrax®
seriesTKK
seriesTKP35
seriesUNIFLEX
Advanced
seriesQuickTrax®
seriesMONO
seriesMaterials
informationConfiguration
guidelinesCable carrier
configuration

Cable carrier

Unsupported arrangement			Gliding arrangement			Inner Distribution				Movement			Page
Travel length ≤ [m]	$v_{max} \leq [m/s]$	$a_{max} \leq [m/s^2]$	Travel length ≤ [m]	$v_{max} \leq [m/s]$	$a_{max} \leq [m/s^2]$	TS0	TS1	TS2	TS3	vertical hanging or standing	lying on the side	rotating arrangement	
										•	•	•	228
4.8	3	9	120	2.5	9	•	•	-	-	•	•	•	228
4.8	3	9	-	-	-	•	•	-	-	•	•	•	229

Cable carrier

Cable carrier configuration

Configuration guidelines

Materials information

MONO series

QuickTrax® series

UNIFLEX Advanced series

TKP35 series

TKK series

EasyTrax® series

TKK39



Pitch
39 mm



Inner height
39 mm



Inner width
39 - 99 mm



Bending radii
46 - 95 mm

Stay variants

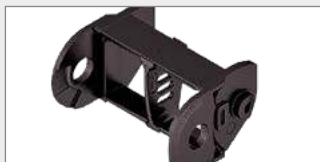

Design 020 page 228

Closed frame

- » Weight-optimised, closed plastic frame with particularly high torsional rigidity.
- » **Outside/inside:** closed.



Design 040 page 229

Frame with inside opening crossbar

- » Weight-optimised plastic frame with particularly high torsional rigidity.
- » Crossbars can be opened at any position on one side.
- » **Inside:** openable.

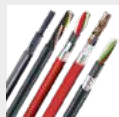

TRAXLINE® cables for cable carriers

Hi-flex electric cables which were specially developed, optimised and tested for use in cable carriers can be found at tsubaki-kabelschlepp.com/traxline.

Additional product information online



Installation instructions, etc.:
Additional information via your smartphone or online at tsubaki-kabelschlepp.com/downloads



Configure your cable carrier here:
online-engineer.de

Unsupported arrangement

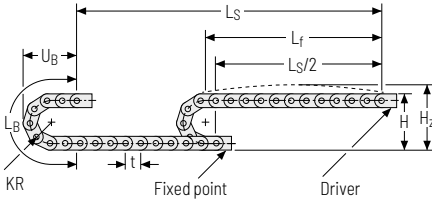

KR [mm]	H [mm]	H _z [mm]	L _B [mm]	U _B [mm]
46	142	172	222	149
58	166	196	260	161
70	190	220	298	173
95	240	270	376	198

Load diagram for unsupported length depending on the additional load.

Sagging of the cable carrier is technically permitted for extended travel lengths, depending on the specific application.

Intrinsic cable carrier weight $q_k = 1.56 \text{ kg/m}$. The maximum additional load changes with deviating inner widths.

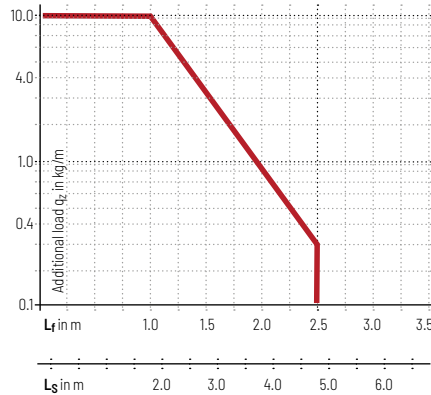

Speed
up to 3 m/s

Acceleration
up to 9 m/s^2

Travel length
up to 4.8 m

Additional load
up to 10 kg/m

Gliding arrangement

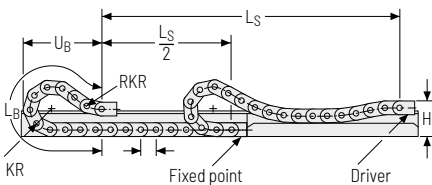

KR [mm]	H [mm]	n _{RKR}	L _B [mm]	U _B [mm]
46	142	0	222	149
58	150	2	405	196
70	150	3	551	257
95	150	4	770	341

Speed
up to 2.5 m/s

Acceleration
up to 9 m/s^2

Travel length
up to 120 m

Additional load
up to 10 kg/m

The gliding cable carrier must be guided in a channel. See p. 844.

Glide shoes must be used for gliding applications.

Only design 020 can be used for a gliding arrangement.

Stay variant 020 – closed frame

- » Weight-optimised, closed plastic frame with particularly high torsional rigidity.
- » **Outside/inside:** closed.



Stay arrangement on each chain link (**VS: fully-stayed**)



B_i 39 - 99 mm

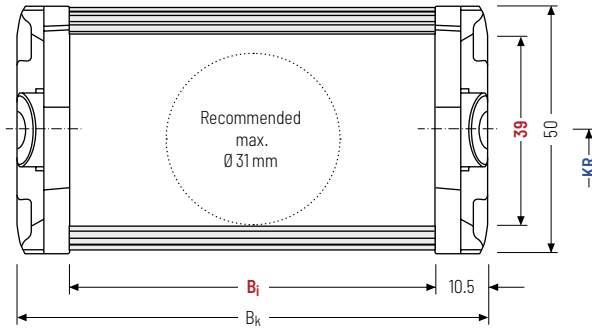

The maximum cable diameter strongly depends on the bending radius and the desired cable type. Please contact us.

Calculating the cable carrier length

Cable carrier length L_k

$$L_k \approx \frac{L_S}{2} + L_B$$

Cable carrier length L_k rounded to pitch t

h_i [mm]	h_C [mm]	B_i [mm]				B_k [mm]	KR [mm]				q_k [kg/m]
39	50	39	59	74	99	$B_i + 21$	46	58	70	95	1.29 - 1.71

Order example



TKK39

Type

020

Stay variant

74

B_i [mm]

70

KR [mm]

1950

L_k [mm]

VS

Stay arrangement

Stay variant 040 – with inside opening crossbar

- » Weight-optimised plastic frame with particularly high torsional rigidity.
- » Crossbars can be opened at any position on one side.
- » **Inside:** openable.



Stay arrangement on each chain link (**VS: fully-stayed**)



B_i 39 – 99 mm

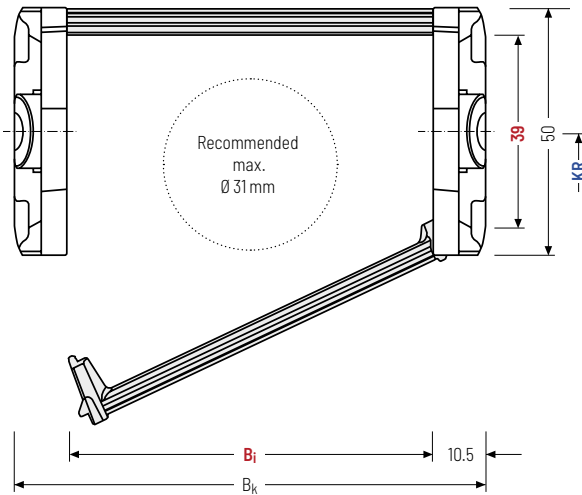

The maximum cable diameter strongly depends on the bending radius and the desired cable type. Please contact us.

Calculating the cable carrier length

Cable carrier length L_k

$$L_k \approx \frac{L_S}{2} + L_B$$

Cable carrier length L_k rounded to pitch t

h_i [mm]	h_c [mm]	B_i [mm]				B_k [mm]	KR [mm]				q_k [kg/m]
39	50	39	59	74	99	$B_i + 21$	46	58	70	95	1.29 – 1.72

Order example



TKK39	040	74	70	1950	VS
Type	Stay variant	B_i [mm]	KR [mm]	L_k [mm]	Stay arrangement

Divider systems

The divider system is mounted on every 2nd chain link as a standard.

Dividers, and the complete divider system (dividers with height separations) comes as diameter adjustable as standard (**version A**).

For applications with lateral accelerations and applications with the cable carrier rotated by 90°, the dividers can easily be fixed on the stay.

The arresting cams snap into the catch profiles in the crossbars (**version B**).

Divider system TSO without height separation

Vers.	a _T min [mm]	a _x min [mm]	a _c min [mm]	a _x grid [mm]	nr min
A	5	10	7	-	-
B*	9.5	10	7	2	-

* not for design 020

The dividers can be moved in the cross section.

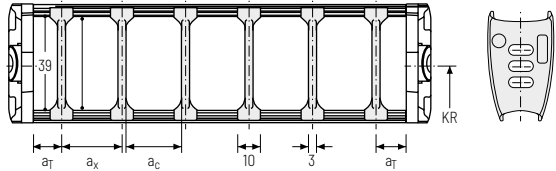

Divider system TS1 with continuous height separation*

Vers.	a _T min [mm]	a _x min [mm]	a _c min [mm]	a _x grid [mm]	nr min
A	5	10	7	-	2
B	9.5	10	7	2	2

* not for design 020

The dividers can be moved in the cross section.

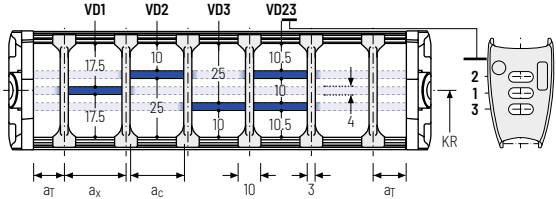

Order example



TS1	.	A	.	3	-	VD1
⋮						
- VD3						
Divider system		Version		nr		Height separation

Please state the designation of the divider system (**TS0**, **TS1**,...), the version, and the number of dividers per cross section [nr].

When using divider systems with height separation (**TS1**), please additionally state the position (e.g. VD1) viewed from the left driver belt. You are welcome to add a sketch to your order.

End connectors - steel

The steel end connectors can be connected **from above or below**. The connection type can be changed by altering the position of the end connector.

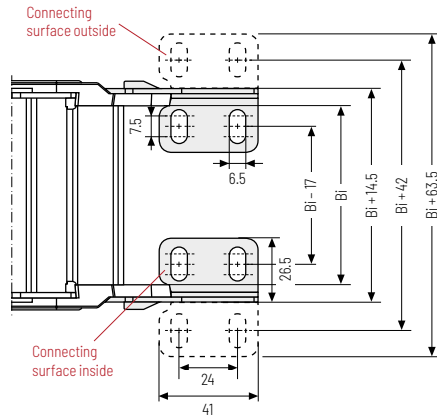
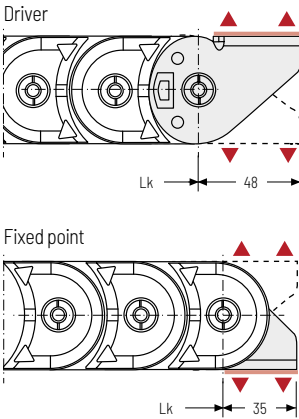

▲ Assembly options

Connection point

- F - fixed point
- M - driver

Connection type

- A - connecting surface outside
- I - connecting surface inside

Connecting surface

- A - threaded joint outside (standard)
- I - threaded joint inside

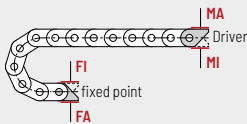

Order example

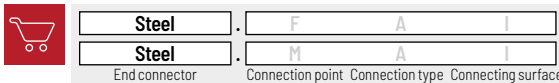

We recommend the use of strain reliefs at the driver and fixed point. See from p. 904.

Cable carrier

Cable carrier configuration

Configuration guidelines

Materials information

MONO series

QuickTrax® series

UNIFLEX Advanced series

TKP35 series

TKK series

EasyTrax® series

Additional product information online



Installation instructions, etc.:
Additional info via your smartphone or check online at tsubaki-kabelschlepp.com/downloads



Configure your cable carrier here:
online-engineer.de

Cable carrier

Cable carrier
configurationConfiguration
guidelinesMaterials
informationMONO
seriesQuickTrax[®]
seriesUNIFLEX
Advanced
seriesTKP35
seriesTKK
seriesEasyTrax[®]
series

BASIC-LINE^{PLUS}

Solid plastic cable carriers with fixed chain widths

The product types from BASIC-LINE^{PLUS} feature pre-defined cable carrier widths and extremely fast cable laying. All combine robustness and reliability with an attractive price-performance ratio.

- » Cost-effective solutions for standard applications
- » Numerous types and designs available immediately from our warehouse
- » Cables are simply pressed/pulled into the cable carrier
- » Ideal for short travel lengths and high travel speeds
- » Very fast cable laying

Not all technical data and parameters are reached in each individual case, but are depending on the respective type of application and product configuration. Legally binding insofar as only the individual information provided for the specifically requested particular case. Please contact us - we will be happy to advise you!



Cable carrier

Cable carrier
configurationConfiguration
guidelinesMaterials
informationMONO
seriesQuickTrax®
seriesUNIFLEX
Advanced
seriesTKP35
seriesTKK
seriesEasyTrax®
series

EasyTrax® series Page 234

Extremely fast cable laying
thanks to easy cable insertion



PROTUM® series Page 262

Small, light cable carrier
for unsupported applications

EasyTrax[®] series

Extremely fast
cable laying
thanks to easy
cable insertion



Trademarks are legally protected for the TSUBAKI KABELSCHLEPP GmbH
as a national or international registration in the following countries:
tsubaki-kabelschlepp.com/trademarks

Subject to change without notice.

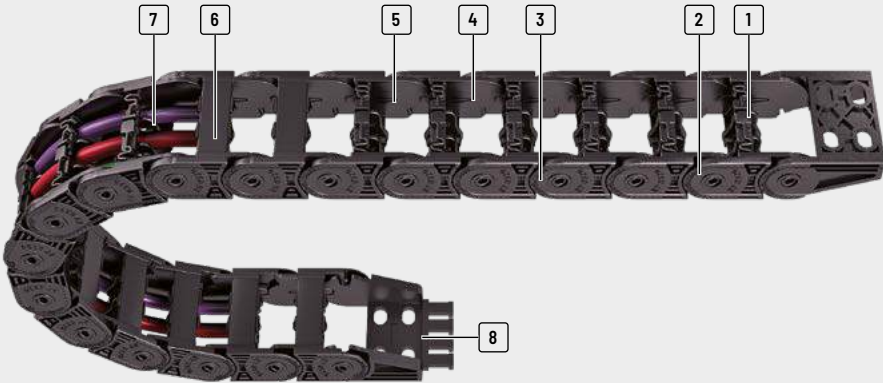

- | | | | |
|--|--|--|--|
| <p>1 Sturdy 2-component design: solid chain body, flexible film hinge</p> <p>2 Plastic chain links</p> | <p>3 Extensive unsupported length</p> <p>4 Inside space is gentle on the cables - no interfering edges</p> | <p>5 Very quiet through integrated noise damping</p> <p>6 Inside or outside openable</p> | <p>7 Dividers for cable separation</p> <p>8 Single-part end connectors with integratable strain relief</p> |
|--|--|--|--|

Features

- | | |
|---|---|
| <ul style="list-style-type: none"> » Very fast cable laying by simply pressing in the cables » Very high fill level through lateral swivelling of the lamella - lamellae do not swivel into the cable space » Each chain link consists of two different materials: <ul style="list-style-type: none"> - Hard chain body made of glass-fibre reinforced material - Lamellae with flexible film hinge made of special elastic plastic | <ul style="list-style-type: none"> » Sturdy cable carrier design » High torsional rigidity » Extensive unsupported length » Very quiet through integrated noise damping |
|---|---|

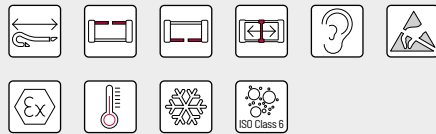

Fast and easy installation of cables



Very high fill level



High side stability



Divider systems for reliable cable separation

Cable carrier

Cable carrier configuration

Configuration guidelines

Materials information

MONO series

QuickTrax® series

UNIFLEX Advanced series

TKP35 series

TKK series

EasyTrax® series

Cable carrier

Cable carrier configuration

Configuration guidelines

Materials information

MONO series

QuickTrax® series

UNIFLEX Advanced series

TKP35 series

TKK series

EasyTrax® series

Cable carrier design

Solid plastic cable carriers: chain links and end connectors made of plastic

Each chain link consists of two different materials:

- » Hard cable carrier body made of glass fiber-reinforced material
- » Flexible lamellae made of elastic plastic

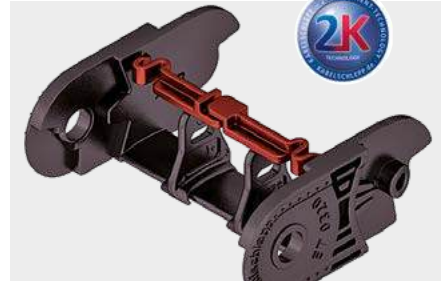

The two-component technology

The two-component technology of the EasyTrax® combines two seemingly incompatible features: **stability and flexibility**.

Cable carriers need to be extremely sturdy, with extensive unsupported length. At the same time, cables need to be inserted easily for fast cable laying. The EasyTrax® meets

these requirements thanks to its innovative design and material combination of a hard cable carrier body made from fiber glass reinforced material and lamellae made of elastic plastic.

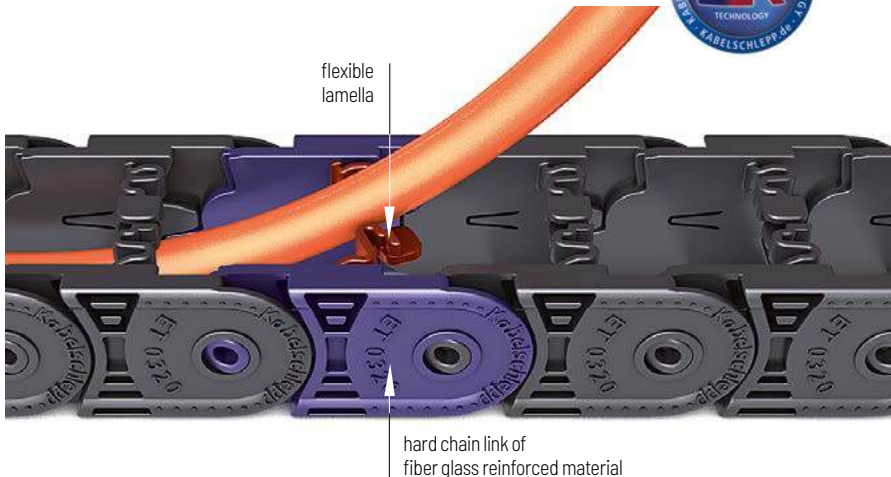
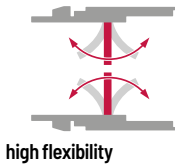

Comparison of dimensions

Manufacturer	h_i [mm]	h_G [mm]	t [mm]	Identical connection hole pattern
ET0320	18	25.5	32	yes
Competitive product	19	25	30.5	yes

Comparison of bending moment

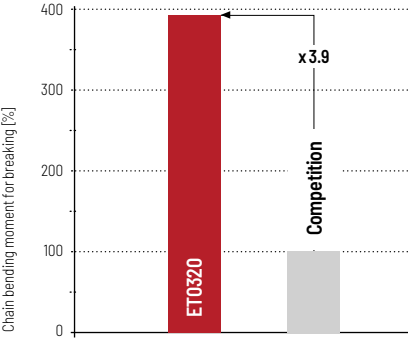

Comparison of bending strength

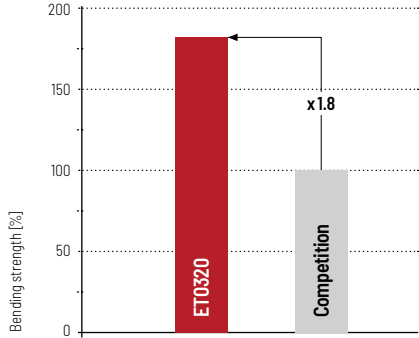

Load diagram

for unsupported length depending on additional load

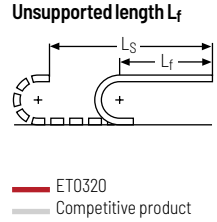
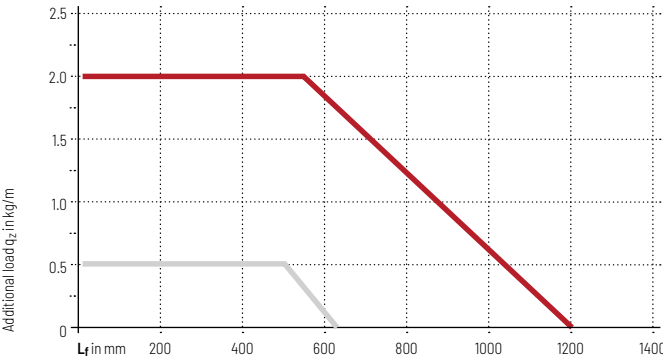

Advantages over competitive product

- » 4 times bigger additional load compared to competitive product
- » Double unsupported length compared to competitive product
- » Faster cable laying at a higher utilization faktor
- » Low noise operation due to internal damping system
- » High side stability through locking in the stroke system
- » Dividers can be used for cable separation

Cable carrier
Cable carrier configuration
Configuration guidelines
Materials information
MONO series
QuickTrax® series
UNIFLEX Advanced series
TKP35 series
TKK series

Type	Opening variant	Stay variant	h_i [mm]	h_G [mm]	B_i [mm]	B_k [mm]	B_i - grid [mm]	t [mm]	KR [mm]	Additional load ≤ [kg/m]	Cable- d_{max} [mm]
ET0115											
		040	4.6	8	7	11	-	11.5	10	0.4	3.5
ET0250											
		030	16.5	23	30 - 50	60	-	25	28 - 100	4	13
		040	16.5	23	30 - 50	60	-	25	28 - 100	4	13
ET0320											
		030	18	25.5	15 - 65	27 - 77	-	32	28 - 125	1.2	14
		040	18	25.5	15 - 65	27 - 77	-	32	28 - 125	1.2	14
ET1455											
		030	25	36	25 - 78	94	-	45.5	52 - 200	6	20
		040	25	36	25 - 78	94	-	45.5	52 - 200	6	20

Unsupported arrangement			Gliding arrangement			Inner Distribution				Movement			Page
Travel length ≤ [m]	$v_{max} \leq [m/s]$	$a_{max} \leq [m/s^2]$	Travel length ≤ [m]	$v_{max} \leq [m/s]$	$a_{max} \leq [m/s^2]$	TS0	TS1	TS2	TS3	vertical hanging or standing	lying on the side	rotating arrangement	
0.68	3	10	-	-	-	-	-	-	-	•	-	-	242
1.6	10	50	60	3	30	•	-	-	-	•	-	•	246
1.6	10	50	-	-	-	•	-	-	-	•	-	•	247
2.90	10	50	80	2.5	25	•	-	-	-	•	-	•	252
2.90	10	50	-	-	-	•	-	-	-	•	-	•	253
4.80	10	50	-	-	-	-	-	-	-	•	-	•	258
4.80	10	50	-	-	-	-	-	-	-	•	-	•	259

Cable carrier

Cable carrier configuration

Configuration guidelines

Materials information

MONO series

QuickTrax® series

UNIFLEX Advanced series

TKP35 series

TKK series

EasyTrax® series

ET0115



Pitch
11.5 mm



Inner height
4.6 mm



Inner width
7 mm



Bending radius
10 mm

Stay variants



Design 040 page 242

Frame with lamellae in the inner radius

- » Weight-optimised plastic frame with particularly high torsional rigidity.
- » Swivelling at any position on one side.
- » **Inside:** swivelling.



TOTALTRAX® complete systems

Benefit from the advantages of the TOTALTRAX® complete system. A complete delivery from one source – with a warranty certificate on request! Learn more at tsubaki-kabelschlepp.com/totaltrax



TRAXLINE® cables for cable carriers

Hi-flex electric cables which were specially developed, optimised and tested for use in cable carriers can be found at tsubaki-kabelschlepp.com/traxline.

Unsupported arrangement

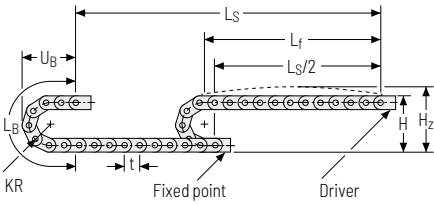

KR [mm]	H [mm]	H _z [mm]	L _B [mm]	U _B [mm]
10	28	38	54.5	25.5

Load diagram for unsupported length depending on the additional load.

Intrinsic cable carrier weight $q_k = 0.044 \text{ kg/m}$ with $B_3 = 7 \text{ mm}$. For other inner widths, the maximum additional load changes.

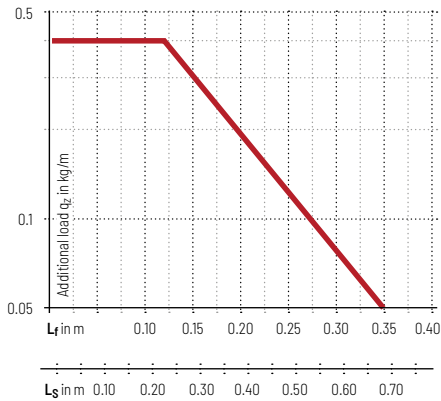

Speed
up to 3 m/s

Acceleration
up to 10 m/s²

Travel length
up to 0.68 m

Additional load
up to 0.4 kg/m

Cable carrier
Cable carrier configuration
Configuration guidelines
Materials information
MONO series
QuickTrax® series
UNIFLEX Advanced series
TKP35 series
TKK series

Additional product information online



Installation instructions, etc.:
Additional info via your smartphone or check online at tsubaki-kabelschlepp.com/downloads



Configure your cable carrier here:
online-engineer.de

Stay variant 040 – with lamella in the inner radius

- » Weight-optimised plastic frame with particularly high torsional rigidity.
- » Can be swivelled at any position on one side.
- » **Inside:** swivelling.



Stay arrangement on each chain link (**VS: fully-stayed**)



B_i 7 mm

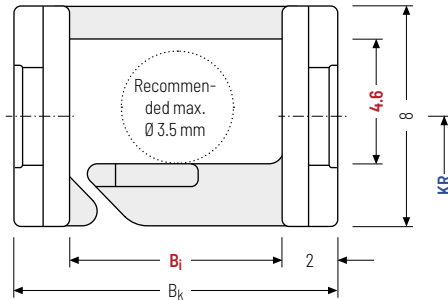

The maximum cable diameter strongly depends on the bending radius and the desired cable type. Please contact us.

Calculating the cable carrier length

Cable carrier length L_k

$$L_k \approx \frac{L_S}{2} + L_B$$

Cable carrier length L_k
rounded to pitch t

h_i [mm]	h_g [mm]	B_i [mm]	B_k [mm]	KR [mm]	q_k [kg/m]
4.6	8	7	$B_i + 4$	10	0.044

Order example



ET0115
Type

040
Stay variant

7
 B_i [mm]

10
KR [mm]

1,280
 L_k [mm]

VS
Stay arrangement

End connector – plastic

The plastic end connectors can be connected **from above or below**.

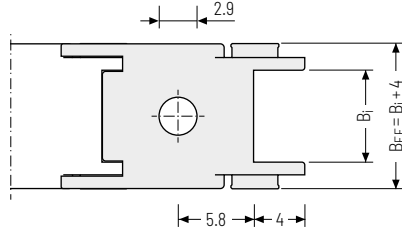
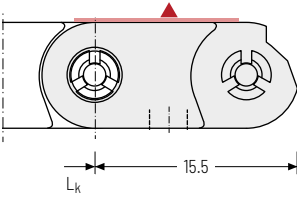

▲ Assembly options

 The end connectors can be swivelled in the KR direction.

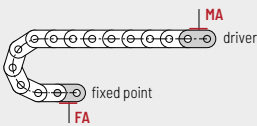

Connection point
F – fixed point
M – driver

Connection type
A – threaded joint outside (standard)

Order example

	End connector	.	F	A
	End connector	.	M	A
	End connector		Connection point	Connection type

Cable carrier
Cable carrier configuration
Configuration guidelines
Materials information
MONO series
QuickTrax® series
UNIFLEX Advanced series
TKP35 series
TKK series

ET0250



Pitch
25 mm



Inner height
16.5 mm



Inner widths
30 – 50 mm



Bending radii
28 – 100 mm

Stay variants



Design 030 page **246**

Frame with lamellae in the outer radius

- » Weight-optimised plastic frame with particularly high torsional rigidity.
- » Lamellae can be swivelled at any position on one side.
- » **Outside:** swivelling.



Design 040 page **247**

Frame with lamellae in the inner radius

- » Weight-optimised plastic frame with particularly high torsional rigidity.
- » Lamellae can be swivelled at any position on one side.
- » **Inside:** swivelling.



UNIFLEX Advanced

For a non-opening cable carrier with 17.5 mm inner height we recommend the series UNIFLEX Advanced **UA1250 from page 150.**

Unsupported arrangement

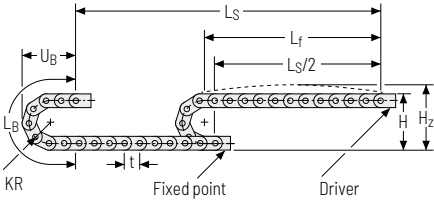



KR [mm]	H [mm]	H _z [mm]	L _B [mm]	U _B [mm]
28	79	104	138	65
38	99	124	169	75
45	113	138	191	82
60	143	168	238	97
75	173	198	286	112
100	223	248	364	137

Load diagram for unsupported length depending on the additional load.

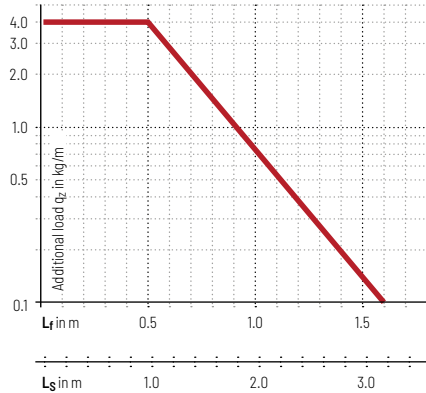



Intrinsic cable carrier weight $q_k = 0.36 \text{ kg/m}$ with $B_3 50 \text{ mm}$. For other inner widths, the maximum additional load changes.

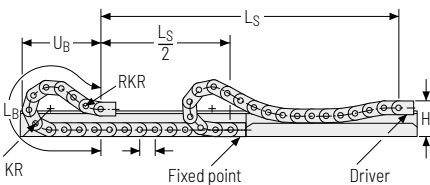

-  **Speed**
up to 10 m/s
-  **Acceleration**
up to 50 m/s^2
-  **Travel length**
up to 1.6 m
-  **Additional load**
up to 4 kg/m

Gliding arrangement



-  **Speed**
up to 3 m/s
-  **Acceleration**
up to 30 m/s^2
-  **Travel length**
up to 60 m
-  **Additional load**
up to 4kg/m

 The gliding cable carrier must be guided in a channel. See p. 844.

Only design 030 can be used for a gliding arrangement.

Cable carrier
Cable carrier configuration
Configuration guidelines
Materials information
MONO series
QuickTrax® series
UNIFLEX Advanced series
TKP35 series
TKK series

Stay variant 030 – with lamellae in the outer radius

- » Weight-optimised plastic frame with particularly high torsional rigidity.
- » Lamellae can be swivelled at any position on one side
- » **Outside:** swivelling.



Stay arrangement on each chain link (**VS: fully-stayed**)



B_i 30 – 50 mm

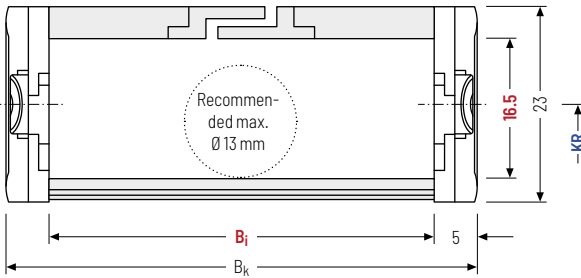

The maximum cable diameter strongly depends on the bending radius and the desired cable type. Please contact us.

Calculating the cable carrier length

Cable carrier length L_k

$$L_k \approx \frac{L_S}{2} + L_B$$

Cable carrier length L_k
rounded to pitch t

h_i [mm]	h_g [mm]	B_i [mm]	B_k [mm]	KR [mm]				q_k [kg/m]		
16.5	23	30 50	$B_i + 10$	28	38	45	60	75	100	0.32 – 0.36

Order example



ET0250

Type

030

Stay variant

50

B_i [mm]

75

KR [mm]

1,110

L_k [mm]

VS

Stay arrangement

Stay variant 040 – with lamellae in the inner radius

- » Weight-optimised plastic frame with particularly high torsional rigidity.
- » Lamellae can be swivelled at any position on one side
- » **Inside:** swivelling.

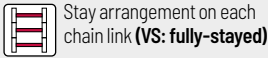

Stay arrangement on each chain link (VS: fully-stayed)



B_i 30 - 50 mm

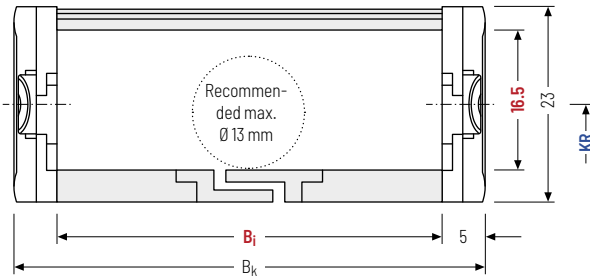

i The maximum cable diameter strongly depends on the bending radius and the desired cable type. Please contact us.

i Design 040 is not suitable for gliding arrangements.

Calculating the cable carrier length

Cable carrier length L_k

$$L_k \approx \frac{L_S}{2} + L_B$$

Cable carrier length L_k rounded to pitch t

h_i [mm]	h_g [mm]	B_i [mm]	B_k [mm]	KR [mm]					q_k [kg/m]	
16.5	23	30 50	$B_i + 10$	28	38	45	60	75	100	0.32 - 0.36

Order example

ET0250
040
50
75
1,100
VS

Type · Stay variant · B_i [mm] · KR [mm] · L_k [mm] · Stay arrangement

	Cable carrier
	Cable carrier configuration
	Configuration guidelines
	Materials information
	MONO series
	QuickTrax® series
	UNIFLEX Advanced series
	TKP35 series
	TKK series

Divider systems

The divider system is mounted on every 2nd chain link as a standard.

As a standard, dividers or the complete divider system (dividers with height separations) are movable in the cross section (**version A**).

For applications with lateral accelerations and applications with the cable carrier rotated by 90°, the dividers can easily be fixed on the stay through rotation.

The arresting cams snap into the catch profiles in the covers (**version B**).

Divider system TSO without height separation

Vers.	a_T min [mm]	a_x min [mm]	a_c min [mm]	a_x grid [mm]	n_T min
A	3	6	4	-	-
B	3	6	4	2	-

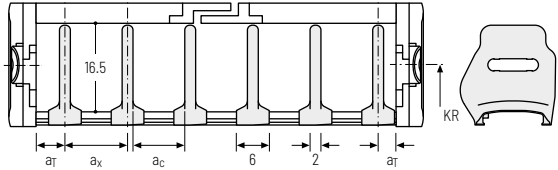

Order example



TSO · **A** · **3**
 Divider system Version n_T

Please state the designation of the divider system (TSO), the version, and the number of dividers per cross section [n_T]. You are welcome to add a sketch to your order.

Additional product information online



Installation instructions, etc.:
 Additional info via your smartphone or
 check online at
[tsubaki-kabelschlepp.com/
 downloads](https://www.tsubaki-kabelschlepp.com/downloads)



Configure your cable carrier here:
[online-engineer.de](https://www.online-engineer.de)

Single-part end connectors – plastic (with integrated strain relief)

The plastic end connectors can be connected **from above or below**. The connection type can be changed by altering the position of the end connector.

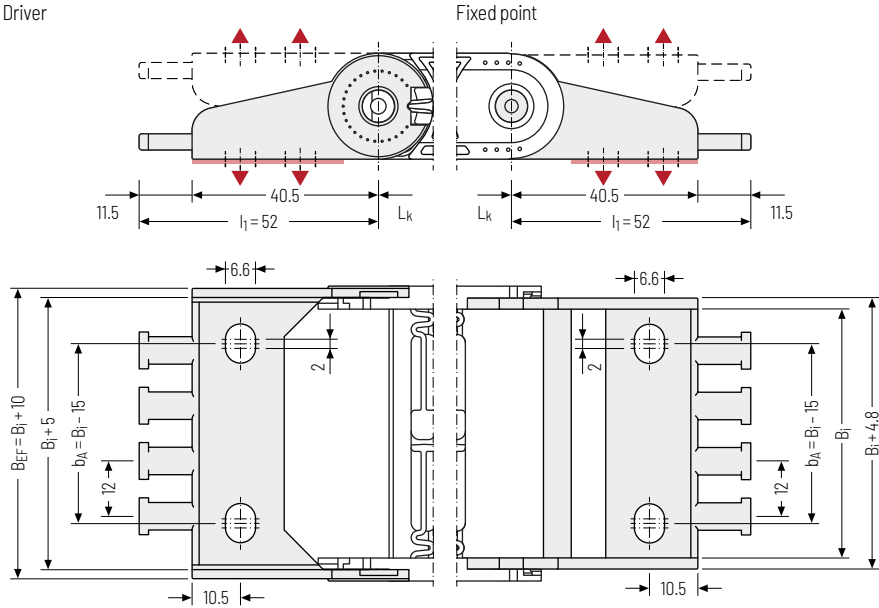

▲ Assembly options

B_i [mm]	B_{EF} [mm]	n_z
30	40	2
50	60	4

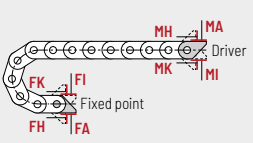

Connection point

- F – fixed point
- M – driver

Connection type

- A – threaded joint outside (standard)
- I – threaded joint inside
- H – threaded joint, rotated 90° to the outside
- K – threaded joint, rotated 90° to the inside

Order example

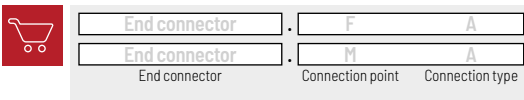

Cable carrier
Cable carrier configuration
Configuration guidelines
Materials information
MONO series
QuickTrax® series
UNIFLEX Advanced series
TKP35 series
TKK series

ET0320



Pitch
32 mm



Inner height
18 mm



Inner widths
15 – 65 mm



Bending radii
28 – 125 mm

Stay variants



Design 030 page 252

Frame with lamellae in the outer radius

- » Weight-optimised plastic frame with particularly high torsional rigidity.
- » Lamellae can be swivelled at any position on one side.
- » **Outside:** swivelling.



Design 040 page 253

Frame with lamellae in the inner radius

- » Weight-optimised plastic frame with particularly high torsional rigidity.
- » Lamellae can be swivelled at any position on one side.
- » **Inside:** swivelling.



TOTALTRAX® complete systems

Benefit from the advantages of the TOTALTRAX® complete system. A complete delivery from one source – with a warranty certificate on request! Learn more at tsubaki-kabelschlepp.com/totaltrax

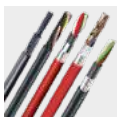

TRAXLINE® cables for cable carriers

Hi-flex electric cables which were specially developed, optimised and tested for use in cable carriers can be found at tsubaki-kabelschlepp.com/traxline.

Unsupported arrangement

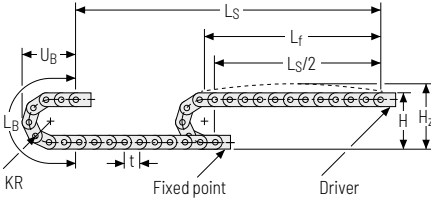



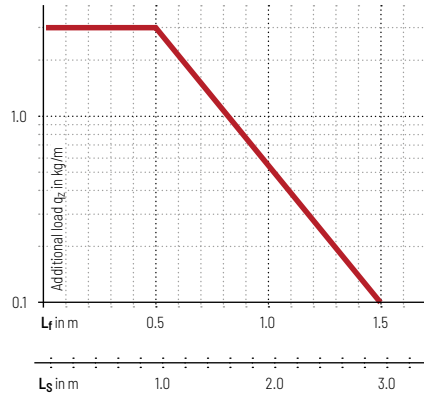

KR [mm]	H [mm]	H _z [mm]	L _B [mm]	U _B [mm]
28	81.5	101.5	152	73
38	101.5	121.5	184	83
48	121.5	141.5	215	93
75	175.5	195.5	300	120
100	225.5	245.5	379	145
125	275.5	295.5	457	170

Load diagram for unsupported length depending on the additional load.





Intrinsic cable carrier weight $q_k = 0.40 \text{ kg/m}$ with B₃ 38 mm. For other inner widths, the maximum additional load changes.

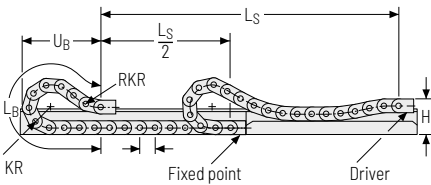

-  **Speed**
up to 10 m/s
-  **Acceleration**
up to 50 m/s^2
-  **Travel length**
up to 2.9 m
-  **Additional load**
up to 1.2 kg/m

Gliding arrangement



-  **Speed**
up to 2.5 m/s
-  **Acceleration**
up to 25 m/s^2
-  **Travel length**
up to 80 m
-  **Additional load**
up to 1.2 kg/m

 The gliding cable carrier must be guided in a channel. See p. 844.

Only design 030 can be used for a gliding arrangement.

Cable carrier
Cable carrier configuration
Configuration guidelines
Materials information
MONO series
QuickTrax® series
UNIFLEX Advanced series
TKP35 series
TKK series
EasyTrax® series

Stay variant 030 – with lamellae in the outer radius

- » Weight-optimised plastic frame with particularly high torsional rigidity.
- » Lamellae can be swivelled at any position on one side
- » **Outside:** swivelling.



Stay arrangement on each chain link (**VS: fully-stayed**)



B_i 15 – 65 mm

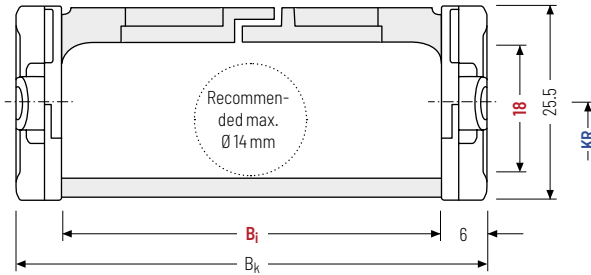

The maximum cable diameter strongly depends on the bending radius and the desired cable type. Please contact us.

Calculating the cable carrier length

Cable carrier length L_k

$$L_k \approx \frac{L_S}{2} + L_B$$

Cable carrier length L_k
rounded to pitch t

h_i [mm]	h_g [mm]	B_i [mm]			B_k [mm]	KR [mm]			q_k [kg/m]					
18	25.5	15	25	38	50	65	$B_i + 12$	28	38	48	75	100	125	0.35 – 0.45

Order example



ET0320

Type

030

Stay variant

50

B_i [mm]

100

KR [mm]

1,280

L_k [mm]

VS

Stay arrangement

Stay variant 040 – with lamellae in the inner radius

- » Weight-optimised plastic frame with particularly high torsional rigidity.
- » Lamellae can be swivelled at any position on one side
- » **Inside:** swivelling.



 Stay arrangement on each chain link (**VS: fully-stayed**)

 B_i 15 – 65 mm

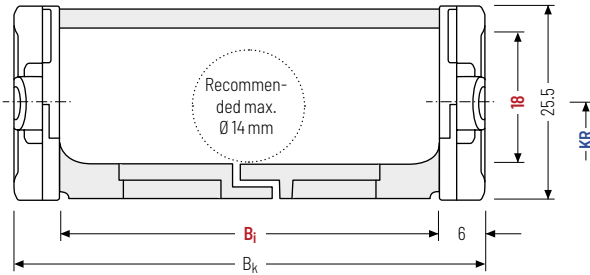

 The maximum cable diameter strongly depends on the bending radius and the desired cable type. Please contact us.

 Design 040 is not suitable for gliding arrangements.

Calculating the cable carrier length

Cable carrier length L_k

$$L_k \approx \frac{L_S}{2} + L_B$$

Cable carrier length L_k rounded to pitch t

h_i [mm]	h_g [mm]	B_i [mm]		B_k [mm]		KR [mm]				q_k [kg/m]				
18	25.5	15	25	38	50	65	$B_i + 12$	28	38	48	75	100	125	0.35 – 0.45

Order example

ET0320 ·
 040 ·
 50 ·
 100 ·
 1.280 ·
 VS
 Type · Stay variant · B_i [mm] · KR [mm] · L_k [mm] · Stay arrangement

Cable carrier
Cable carrier configuration
Configuration guidelines
Materials information
MONO series
QuickTrax® series
UNIFLEX Advanced series
TKP35 series
TKK series

Divider systems

The divider system is mounted on every 2nd chain link as a standard.

As a standard, dividers or the complete divider system (dividers with height separations) are movable in the cross section (**version A**).

Divider system TSO without height separation

Vers.	a_T min [mm]	a_x min [mm]	a_c min [mm]	n_T min
A	4	8	6	-

The dividers can be moved in the cross section.

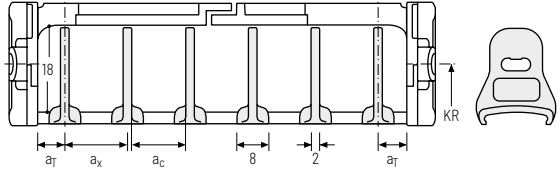

Order example

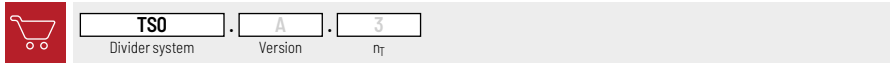

Please state the designation of the divider system (TSO), the version, and the number of dividers per cross section [n_T]. You are welcome to add a sketch to your order.

Additional product information online



Installation instructions, etc.:
Additional info via your smartphone or check online at
[tsubaki-kabelschlepp.com/downloads](https://www.tsubaki-kabelschlepp.com/downloads)



Configure your cable carrier here:
[online-engineer.de](https://www.online-engineer.de)

Single-part end connectors – plastic (with integrated strain relief)

The plastic end connectors can be **connected from above or below**. The connection type can be changed by altering the position of the end connector.

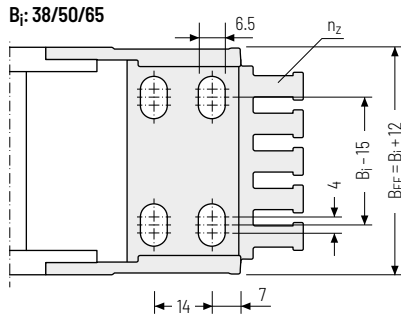
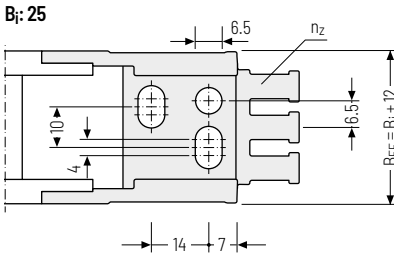
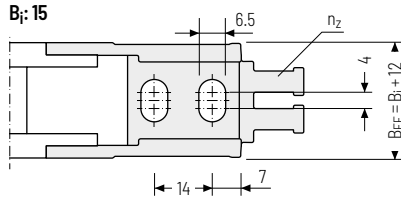
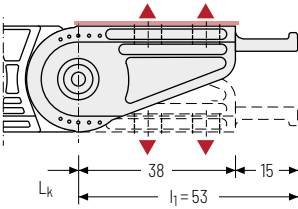

▲ Assembly options

B_i [mm]	B_{EF} [mm]	n₂
15	27	2
25	37	3
38	50	4
50	62	5
65	77	6

The end connectors are also available as an option **without** integrated strain relief. Please state when ordering.

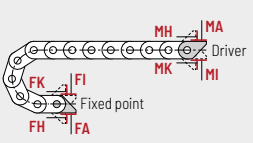

Connection point
F – fixed point
M – driver

Connection type
A – threaded joint outside (standard)
I – threaded joint inside
H – threaded joint, rotated 90° to the outside
K – threaded joint, rotated 90° to the inside

Order example

End connector . F A
 End connector . M A
 End connector Connection point Connection type

Cable carrier

Cable carrier configuration

Configuration guidelines

Materials information

MONO series

QuickTrax® series

UNIFLEX Advanced series

TKP35 series

TKK series

EasyTrax® series

Subject to change without notice.

ET1455

Cable carrier

Cable carrier configuration

Configuration guidelines

Materials information

MONO series

QuickTrax® series

UNIFLEX Advanced series

TKP35 series

TKK series

EasyTrax® series



Pitch
45.5 mm



Inner height
25 mm



Inner width
78 mm

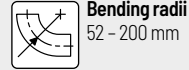

Bending radii
52 – 200 mm

Stay variants



Design 030 page 258

Frame with lamellae in the outer radius

- » Weight-optimised plastic frame with particularly high torsional rigidity.
- » Lamellae can be swivelled at any position on one side.
- » **Outside:** swivelling.



Design 040 page 259

Frame with lamellae in the inner radius

- » Weight-optimised plastic frame with particularly high torsional rigidity.
- » Lamellae can be swivelled at any position on one side.
- » **Inside:** swivelling.



TOTALTRAX® complete systems

Benefit from the advantages of the TOTALTRAX® complete system. A complete delivery from one source – with a warranty certificate on request! Learn more at tsubaki-kabelschlepp.com/totaltrax



TRAXLINE® cables for cable carriers

Hi-flex electric cables which were specially developed, optimised and tested for use in cable carriers can be found at tsubaki-kabelschlepp.com/traxline.

Unsupported arrangement

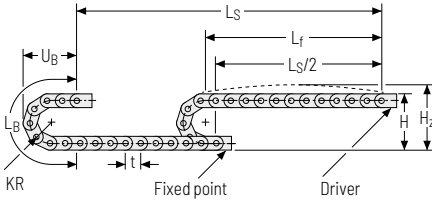

KR [mm]	H [mm]	H ₂ [mm]	L _B [mm]	U _B [mm]
52	140	165	255	116
65	166	191	296	129
95	226	251	390	159
125	286	271	484	189
150	336	361	563	214
180	396	421	657	244
200	436	461	720	264

Load diagram for unsupported length depending on the additional load.

Intrinsic cable carrier weight $q_k = 0.75 \text{ kg/m}$ with $B_i 38 \text{ mm}$. For other inner widths, the maximum additional load changes.

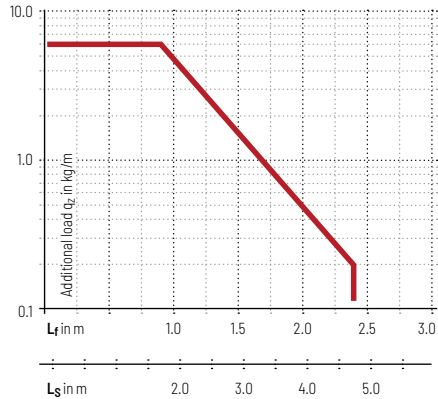

 **Speed**
up to 10 m/s

 **Acceleration**
up to 50 m/s^2

 **Travel length**
up to 4.8 m

 **Additional load**
up to 6.0 kg/m

Cable carrier

Cable carrier configuration

Configuration guidelines

Materials information

MONO series

QuickTrax® series

UNIFLEX Advanced series

TKP35 series

TKK series

EasyTrax® series

Stay variant 030 – with lamellae in the outer radius

- » Weight-optimised plastic frame with particularly high torsional rigidity.
- » Lamellae can be swivelled at any position on one side
- » **Outside:** swivelling.



Stay arrangement on each chain link (**VS: fully-stayed**)



B_i : 25 – 78 mm

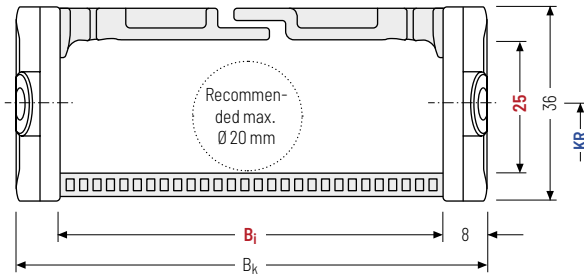

The maximum cable diameter strongly depends on the bending radius and the desired cable type. Please contact us.

Calculating the cable carrier length

Cable carrier length L_k

$$L_k \approx \frac{L_S}{2} + L_B$$

Cable carrier length L_k rounded to pitch t

h_i [mm]	h_G [mm]	h_G' [mm]	B_i [mm]				B_k [mm]	KR [mm]				q_k [kg/m]
25	36	38.5	25	38	58	78	$B_i + 16$	52	65	95	125	0.65 – 0.80
								150	180	200		

Order example



ET1455

Type

030

Stay variant

78

B_i [mm]

150

KR [mm]

1,456

L_k [mm]

VS

Stay arrangement

Stay variant 040 – with lamellae in the inner radius

- » Weight-optimised plastic frame with particularly high torsional rigidity.
- » Lamellae can be swivelled at any position on one side
- » **Inside:** swivelling.

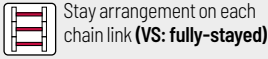

Stay arrangement on each chain link (VS: fully-stayed)



B_i 25 – 78 mm

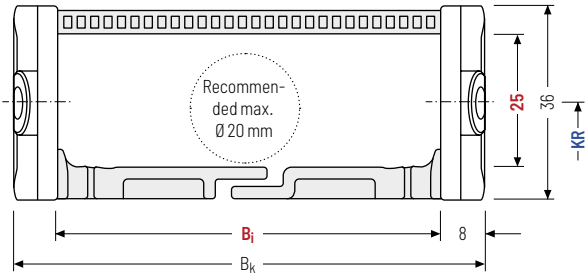

i The maximum cable diameter strongly depends on the bending radius and the desired cable type. Please contact us.

i Design 040 is not suitable for gliding arrangements.

Calculating the cable carrier length

Cable carrier length L_k

$$L_k \approx \frac{L_S}{2} + L_B$$

Cable carrier length L_k rounded to pitch t

h_i [mm]	h_G [mm]	h_G' [mm]	B_i [mm]				B_k [mm]	KR [mm]				q_k [kg/m]
25	36	38.5	25	38	58	78	$B_i + 16$	52	65	95	125	0.65 – 0.80
								150	180	200		

Order example

ET1455 Type ·
 040 Stay variant ·
 78 B_i [mm] ·
 150 KR [mm] ·
 1,456 L_k [mm] ·
 VS Stay arrangement

Cable carrier
Cable carrier configuration
Configuration guidelines
Materials information
MONO series
QuickTrax® series
UNIFLEX Advanced series
TKP35 series
TKK series

Single-part end connectors – plastic

The plastic end connectors can be **connected from above or below**. The connection type can be changed by altering the position of the end connector.

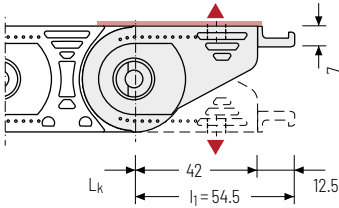

▲ Assembly options

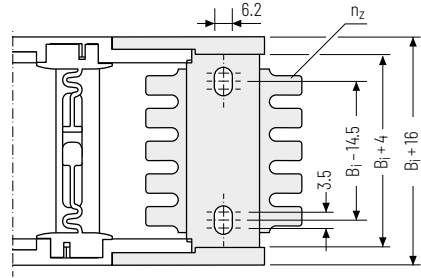

Recommended tightening torque:
6 Nm for screws M6 - 8.8

B_1 [mm]	n_z
25	2 x 2
38	2 x 3
58	2 x 4
78	2 x 6

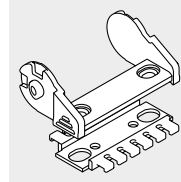

The end connectors are optionally also available **without** strain relief comb.
Please state when ordering.

Cable carrier

Cable carrier configuration

Configuration guidelines

Materials information

MONO series

QuickTrax® series

UNIFLEX Advanced series

TKP35 series

TKK series

EasyTrax® series

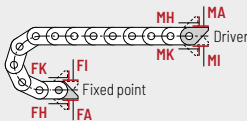

Connection point

- F – fixed point
- M – driver

Connection type

- A – threaded joint outside (standard)
- I – threaded joint inside
- H – threaded joint, rotated 90° to the outside
- K – threaded joint, rotated 90° to the inside

Order example



End connector	.	F	A
End connector	.	M	A
End connector		Connection point	Connection type

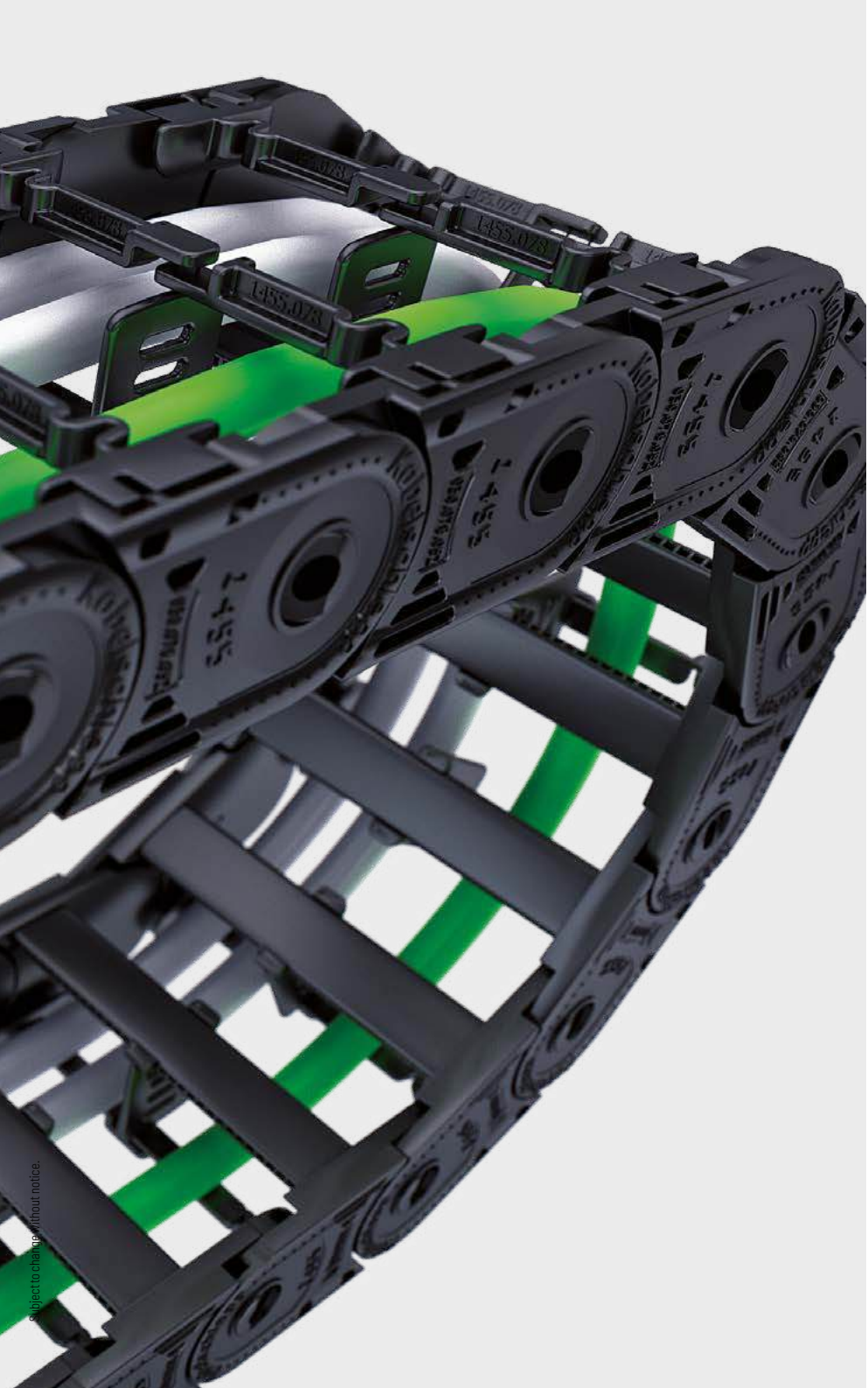

Subject to change without notice.

PROTUM® series

Small, light cable carriers
for modern offices

P0240 GS



Trademarks are legally protected for the TSUBAKI KABELSCHLEPP GmbH
as a national or international registration in the following countries:
tsubaki-kabelschlepp.com/trademarks

Subject to change without notice.

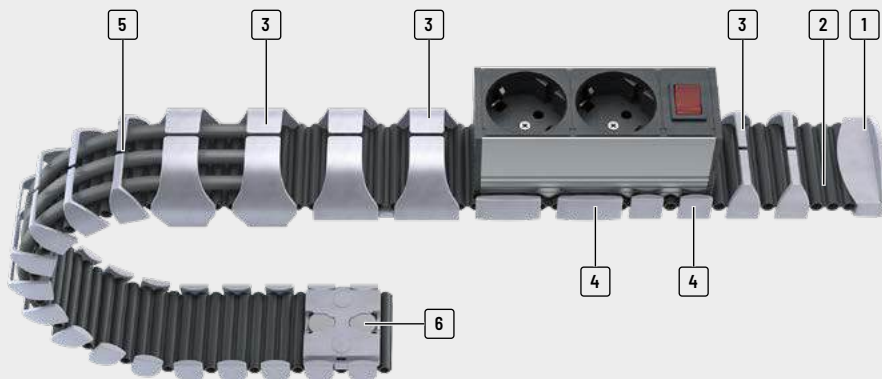

- 1 Variable fastening for table top, table frame, table foot and floor
- 2 Very long service life - no links and therefore no link wear
- 3 Different side parts / inner heights available
- 4 "Clip" side parts for attaching add-on parts
- 5 Cables are simply pressed in
- 6 Variable mounting possible via magnets, screws, adhesive pads, cable ties or integrated clip

Features

- » Solid plastic cable carrier
- » Cost savings through easy cable installation
- » Installation of pre-assembled cables also possible
- » Belt with clip-on side parts
- » Easy adaptation of the chain length
- » Low weight, good ratio between inner and outer width
- » Combination options for end connectors



Available in the standard color variants black, white, and silver gray



Cables are simply pressed in



The basic structure: belt with clip-on side parts



PROTUM OFFICE for office furniture and interiors

PROTUM®
series

K
series

UNIFLEX
Advanced
series

M
series

XL
series

QUANTUM®
series

TKR
series

TKA
series

UAT
series

Color combinations

The standard color variants silver-gray, black and white for the band, the side parts and the connections can be combined.



Black
(RAL 9005)



White
(RAL 9010)



Silver-gray
(RAL 9003)

Carrier band



Side parts „Clip“

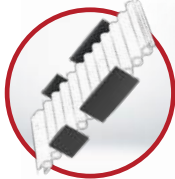

P0240GS / P0400GS01

Side parts



P0240GS

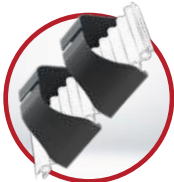

P0400GS01



P0400GS02



P0400GS Module combination

Combination options for end connectors

Can be attached to table frames, underneath table tops or cable ducts, to rectangular or round table legs or to the floor.

Connection A/B/N – angled/oval for table top

for mounting underneath the table top, on the table frame or on the cable duct

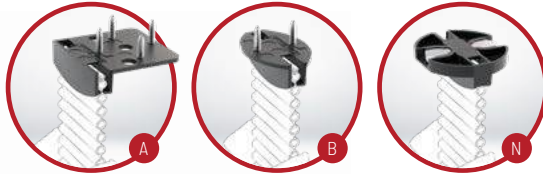

Connection M – for profiles flat

for mounting on rectangular aluminum profiles with groove



Connection C/E + I/J – for flat frames and Connection D/F + K/L – for round frames

for mounting on the table frame (rectangular/ $\varnothing = 70$ mm) using integrated magnets **E F I K** or screws **C D J L** as short **E F C D** or long version **I K J L**

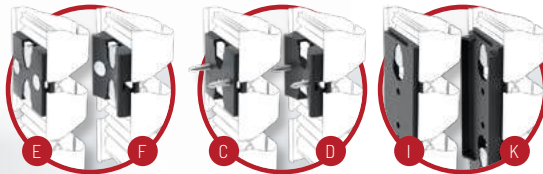

Adhesive pads are also available for optional attachment for connectors **A B** and **J**, and self-adhesive counterholder for non-magnetic surfaces for connectors **E I** and **N**. Connectors **C** and **D** can also be fixed with cable ties.

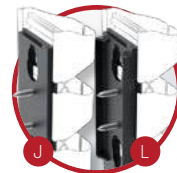

Connection G – for floor connection

for a clean transition to the floor covering



Connection H – for table base

for mounting on the table base by clipping



Type	Opening variant	Stay variant	h_i [mm]	h_G [mm]	B_i [mm]	B_k [mm]	B_i - grid [mm]	t [mm]	KR [mm]	Additional load ≤ [kg/m]	Cable- d _{max} [mm]
------	-----------------	--------------	---------------	---------------	---------------	---------------	-------------------------	-----------	------------	--------------------------------	------------------------------------

P0240 GS



	010	10	23	50	54	-	24	-	-	8
---	-----	----	----	----	----	---	----	---	---	---

P0400 GS



	010	21.5	34	50	55	-	40	-	-	8
---	-----	------	----	----	----	---	----	---	---	---



	010	21.5	53.5	50	55	-	40	-	-	8
---	-----	------	------	----	----	---	----	---	---	---



	010	21,5	53,5	$(2 \times 51) -$ $(2 \times 51 + 3 \times 52)$	109.5 - 273	-	40	-	-	8
--	-----	------	------	--	-------------	---	----	---	---	---

Unsupported arrangement			Gliding arrangement			Inner Distribution				Movement			Page
Travel length ≤ [m]	$V_{max} \leq [m/s]$	$a_{max} \leq [m/s^2]$	Travel length ≤ [m]	$V_{max} \leq [m/s]$	$a_{max} \leq [m/s^2]$	TS0	TS1	TS2	TS3	vertical hanging or standing	lying on the side	rotating arrangement	

-	-	-	-	-	-	-	-	-	-	-	(*)	-	-
---	---	---	---	---	---	---	---	---	---	---	-----	---	---

284

PROTUM® series

K series

UNIFLEX Advanced series

-	-	-	-	-	-	-	-	-	-	-	(*)	-	-
---	---	---	---	---	---	---	---	---	---	---	-----	---	---

284

M series

-	-	-	-	-	-	-	-	-	-	-	(*)	-	-
---	---	---	---	---	---	---	---	---	---	---	-----	---	---

285

XL series

-	-	-	-	-	-	-	-	-	-	-	(*)	-	-
---	---	---	---	---	---	---	---	---	---	---	-----	---	---

QUANTUM® series

TKR series

TKA series

UAT series

P0240 GS

PROTUM OFFICE



Pitch
24 mm



Inner height
10 mm



Inner width
50 mm

This variant for office use is based on the PROTUM® cable carrier system.

With an inner width of 50 mm and cable installation on both sides, PROTUM OFFICE offers sufficient space for telecommunication, energy and data cables in modern offices.

The linkless design can blend into the environment as a

design element, e.g. with an elegant silver-grey optic.

Small, light cable carrier

- » Long service life – no links and therefore no link wear
- » Good ratio of usable space to outer dimensions
- » Easy installation by pressing in the cables
- » Easy to install and fill
- » Suitable for retrofitting
- » Clean, space-saving installation
- » Can be filled on one or both sides

Easy and fast installation

- » Connections for all smooth surfaces
- » Standard connection for table frame, round and square outside the footwell
- » Up to 4 installation options, depending on connection (magnets, screws, cable ties and adhesive tape)
- » Floor connection for sturdy positioning and floor connection

Stay variants



Design 010 page 269

Frame with lamellae in the outer radius

- » Belt with clip-on side parts.
- » **One-sided:** for pressing in.

Stay variant 010 – with lamellae in the outer radius

- » Belt with clip-on side parts.
- » **Outside:** for pressing in.



Stay arrangement on each chain link (**fully stayed**)



B_i 50 mm

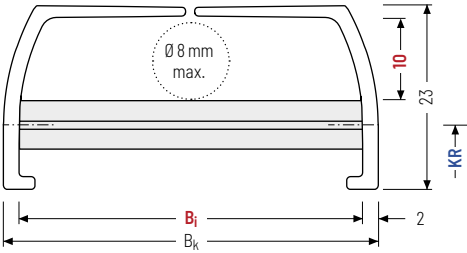

h_i [mm]	h_g [mm]	B_i [mm]	B_k [mm]	q_k [kg/m]
10	23	50	$B_i + 4$	0.28

Standard colors

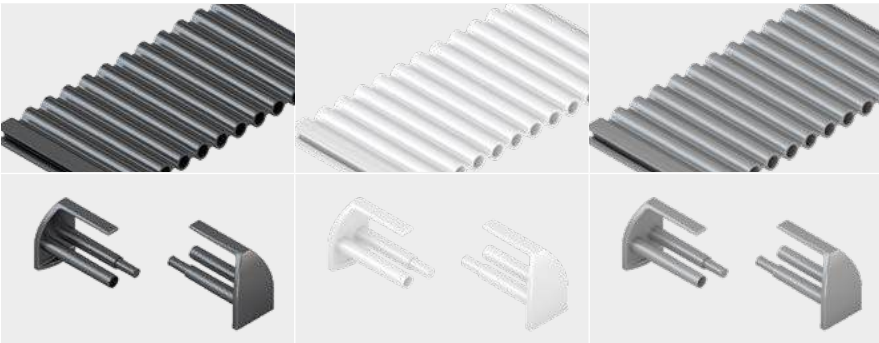

Black (RAL 9005)
Mat. no. 75637*

White (RAL 9010)
Mat. no. 75645*

Silver-gray (RAL 9023)
Mat. no. 75641*



For bulk buyers, the color variants of the belt, the side parts and the connections can be individually combined on request. Colored items may have color differences.

* Length: 960 mm

PROTUM® series

K series

UNIFLEX Advanced series

M series

XL series

QUANTUM® series

TKR series

TKA series

UAT series

Combination options for end connectors

Depending on the design of your office furniture, different combination options are possible for the end connectors. They can be attached underneath table tops/cable conduits, to round or square table legs or to the floor.

Combination options for tables without height adjustment

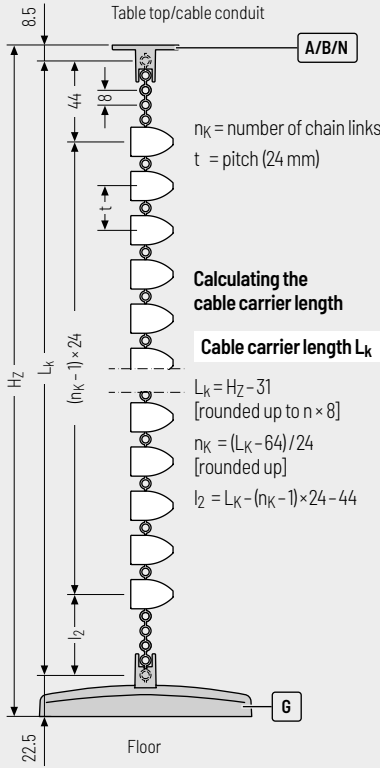

Combination options for tables with height adjustment

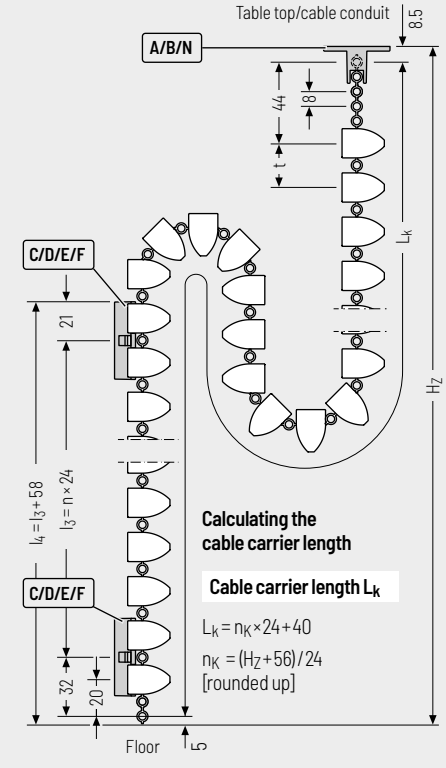

End connectors

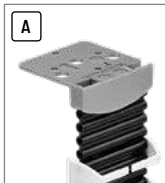

Page 272



Page 272

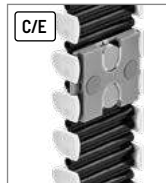

Page 273

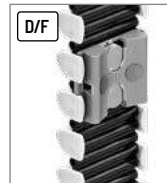

Page 273

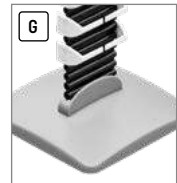

Page 274



All connections and cable carriers can be combined with each other and are available in the colour variants silver-grey, black and white.

Combination options for end connectors

Depending on the design of your office furniture, different combination options are possible for the end connectors. They can be attached underneath table tops/cable conduits, to round or square table legs or to the floor.

Combination options for tables with height adjustment

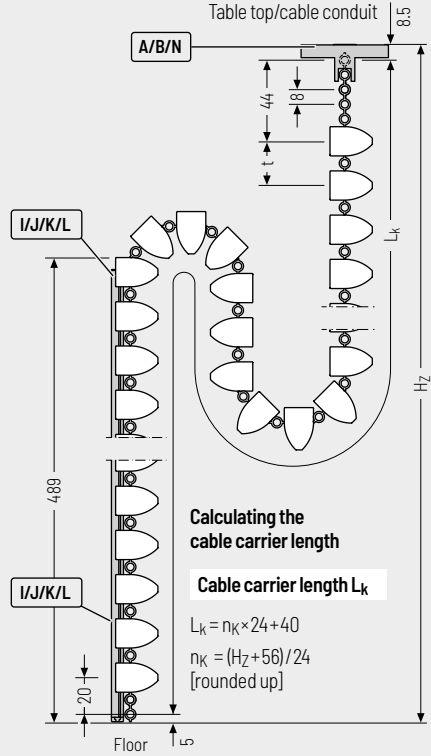
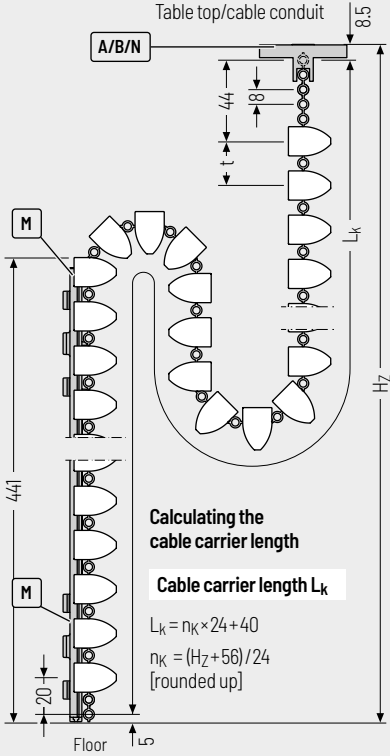

End connectors



Page 274

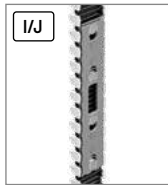

Page 275

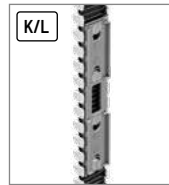

Page 276

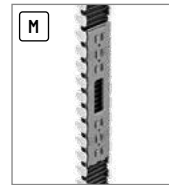

Page 277



Page 278

Subject to change without notice.



All connections and cable carriers can be combined with each other and are available in the colour variants silver-grey, black and white.

PROTUM® series

K series

UNIFLEX Advanced series

M series

XL series

QUANTUM® series

TKR series

TKA series

UAT series

Connection A – angled for table top

Table connection for screw-fixing the cable routing underneath the table top or on a cable conduit.

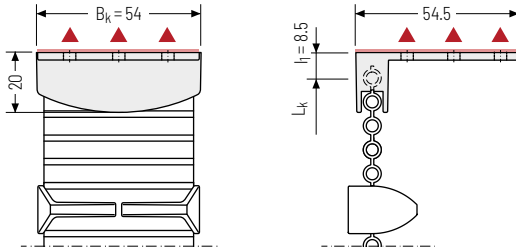

▲ Installation options

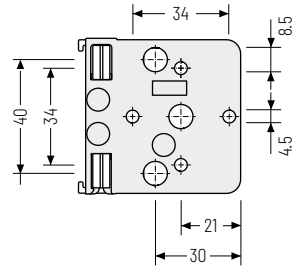

Fixing variant

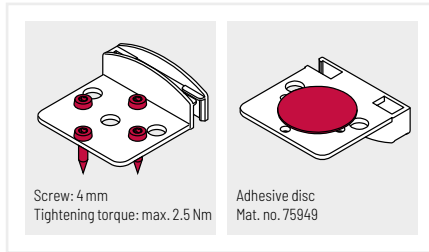

Color variants

- Black
Mat. no. 75739*
- White
Mat. no. 75884*
- Silver-gray
Mat. no. 75876*

*SU = 50 pieces

Connection B – oval for table top

Table connection for screw-fixing the cable routing underneath the table top or on a cable conduit.

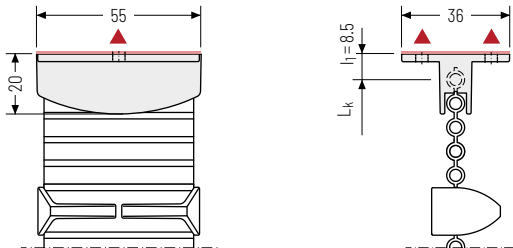

▲ Installation options

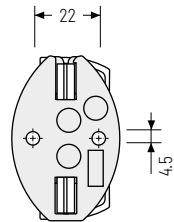

Fixing variant

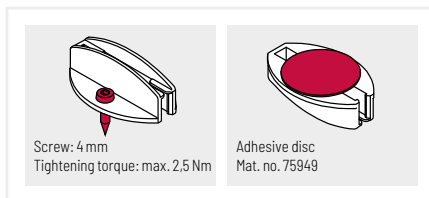

Color variants

- Black
Mat. no. 75740*
- White
Mat. no. 75885*
- Silver-gray
Mat. no. 75877*

*SU = 50 pieces

Also available as magnetic version (Connector N) see p. 278



PROTUM®
series

K
series

UNIFLEX
Advanced
series

M
series

XL
series

QUANTUM®
series

TKR
series

TKA
series

UAT
series

Connection C/E – for flat table frame

Connection for installing the cable routing on a square table frame.
Fixing with integrated magnets, screws or cable ties.

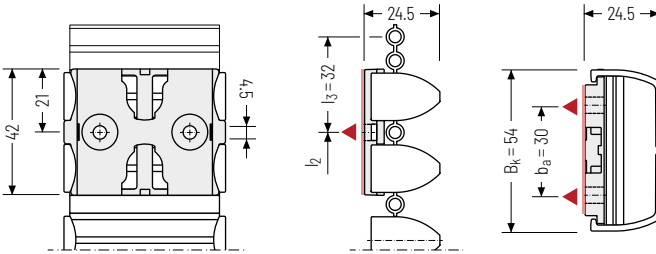



▲ Installation options

 Self-adhesive counterholder available for non-magnetic surfaces!

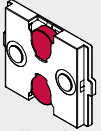
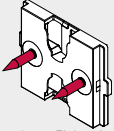
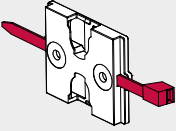
Fixing variants

<p>Connection E</p>  <p>Magnets, Magnetic retention force: max. 40 N</p>	<p>Connection C</p>  <p>Screw: 4 mm, Tightening torque: max. 2.5 Nm</p>	<p>Connection C</p>  <p>Cable tie: 5 mm</p>
--	---	---

Color variants

-  Black (E) Mat. no. 75741* (C) Mat. no. 75742*
-  White (E) Mat. no. 75886* (C) Mat. no. 75887*
-  Silver-gray (E) Mat. no. 75878* (C) Mat. no. 75879*

*SU=50 pieces

Connection D/F – for round table frame

Connection for installing the cable routing on a table frame with 70 mm diameter.
Fixing with integrated magnets, screws or cable ties.

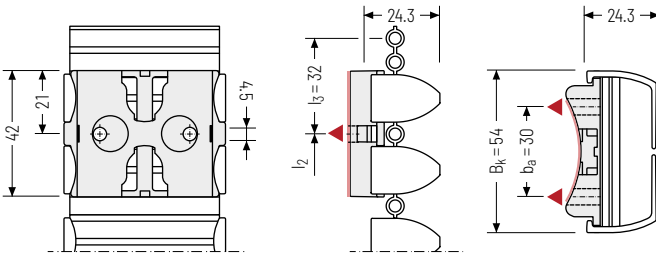

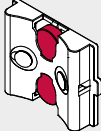
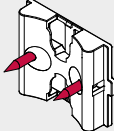
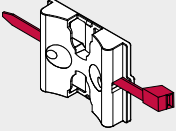

▲ Installation options

Fixing variants

<p>Connection F</p>  <p>Magnets, Magnetic retention force: max. 40 N</p>	<p>Connection D</p>  <p>Screw: 4 mm, Tightening torque: max. 2.5 Nm</p>	<p>Connection D</p>  <p>Cable tie: 5 mm</p>
--	---	---

Color variants

-  Black (F) Mat. no. 75744* (D) Mat. no. 75743*
-  White (F) Mat. no. 75888* (D) Mat. no. 75889*
-  Silver-gray (F) Mat. no. 75880* (D) Mat. no. 75881*

*SU=50 pieces

PROTUM® series
K series
UNIFLEX Advanced series
M series
XL series
QUANTUM® series
TKR series
TKA series
UAT series

Connection G – floor connection

Floor connection for a clean transition of the cable routing to the floor.
Individual colors and designs on request.

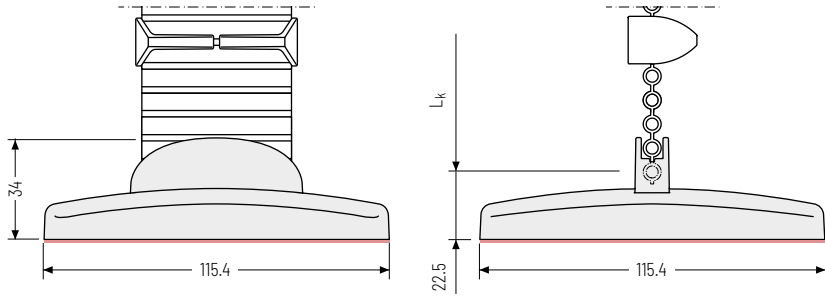
**Color variants**

Black
Mat. no. 75745*



White
Mat. no. 75890*



Silver-gray
Mat. no. 75882*

*SU = 50 pieces

Connection H – for table base

Connection for installing the cable routing on a table base.
Fixing by clipping.

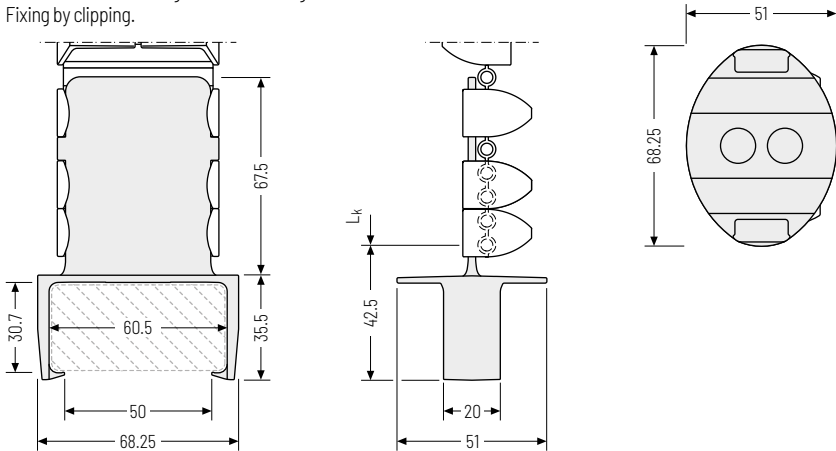
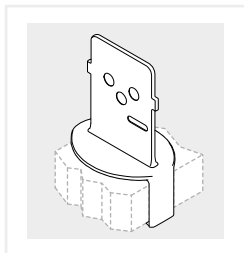
**Fixing variant****Color variants**

Black
Mat. no. 75992*



White
Mat. no. 75994*



Silver-gray
Mat. no. 75993*

*SU = 50 pieces

Connection I/J - for flat table frame

Connection for installing the cable routing on a square table frame. Fixing with integrated magnets or screws.

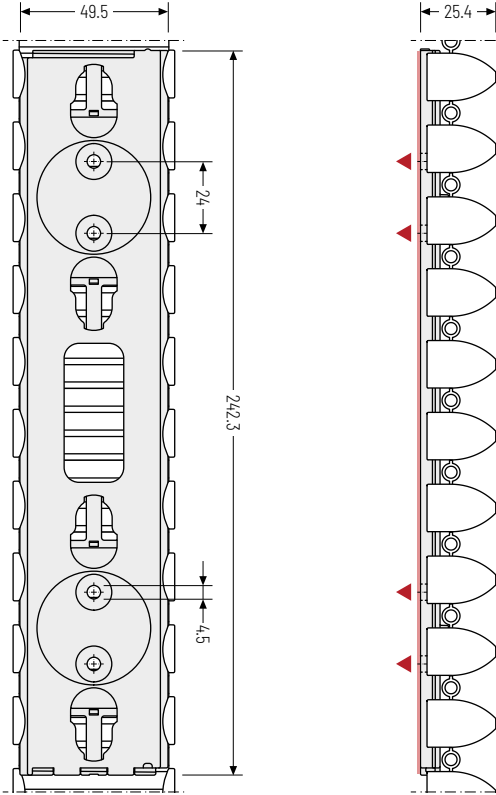

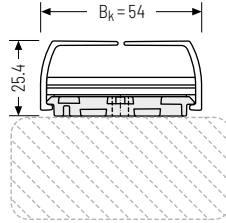

▲ Installation options



 Self-adhesive counterholder available for non-magnetic surfaces!

Color variants

-  Black
(I) Mat. no. 75940*
(J) Mat. no. 75634*
-  White
(I) Mat. no. 75941*
(J) Mat. no. 75635*
-  Silver-gray
(I) Mat. no. 75942*
(J) Mat. no. 75636*

*SU = 50 pieces

Fixing variants

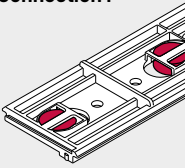
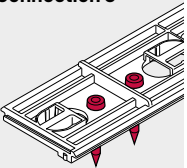
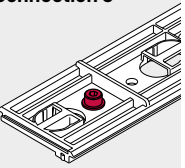
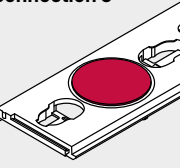
<p>Connection I</p>  <p>Up to 4 magnets, Magnetic retention force: min. 60 N</p>	<p>Connection J</p>  <p>Up to 4 Screws: 4 mm Tightening torque: max. 2.5 Nm</p>	<p>Connection J</p>  <p>For slot nut M4 Cylinder screw: DIN 9612 M4 Washer: DIN 125</p>	<p>Connection J</p>  <p>Adhesive disc Mat. no. 75949</p>
--	---	---	--

Subject to change without notice.

PROTUM® series
K series
UNIFLEX Advanced series
M series
XL series
QUANTUM® series
TKR series
TKA series
UAT series

Connection K/L - for round table frame

Connection for installing the cable routing on a table frame with 70 mm diameter. Fixing with integrated magnets or screws.

▲ Installation options

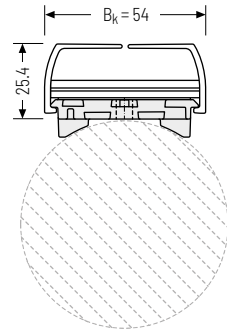
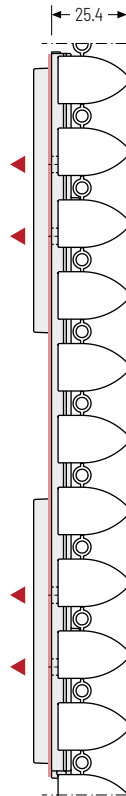
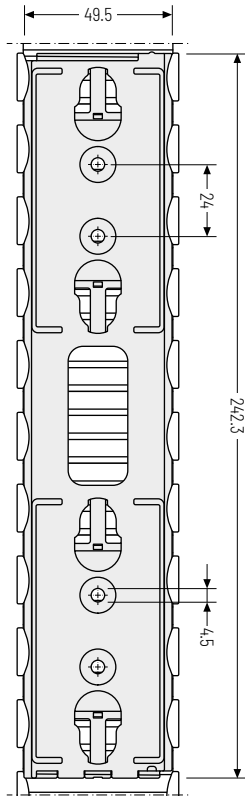

Individual diameters on request.

Color variants

- Black
(K) Mat. no. 75943*
(L) Mat. no. 75647*
- White
(K) Mat. no. 75944*
(L) Mat. no. 75648*
- Silver-gray
(K) Mat. no. 75945*
(L) Mat. no. 75649*

*SU = 50 pieces

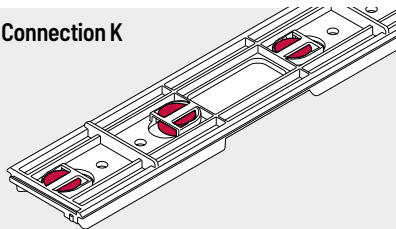
Fixing variants**Connection K**

Up to 4 magnets
Magnetic retention force: min. 60 N

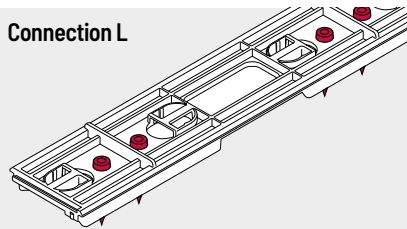
Connection L

Up to 4 Screws: 4 mm
Tightening torque: max. 2.5 Nm

Connection M – for profiles flat

Connection for installing the cable routing on aluminum profiles rectangular. Fixing via integrated clip.

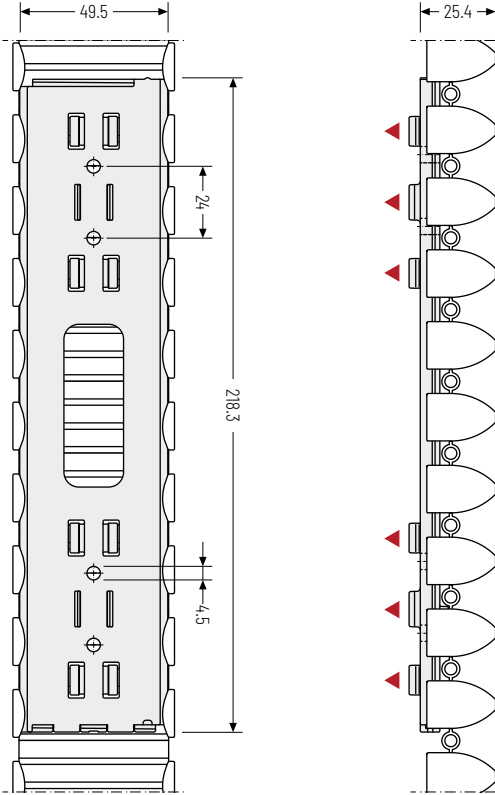

▲ Installation options

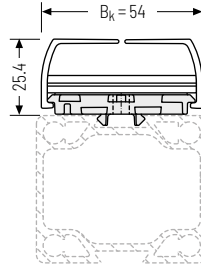

i Individual profile cross-section on request.

Color variants

- Black
Mat. no. 75937*
- White
Mat. no. 75938*
- Silver-gray
Mat. no. 75939*

*SU = 50 pieces

Fixing variant

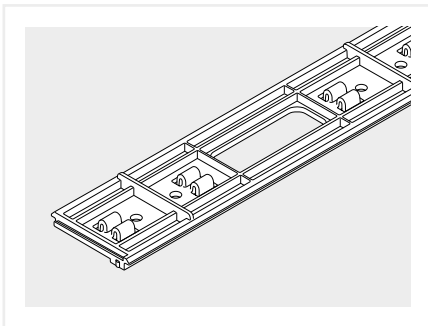

i The assembly depends on the shape of the aluminum profile. Please contact us – we are happy to advise you

PROTUM® series
K series
UNIFLEX Advanced series
M series
XL series
QUANTUM® series
TKR series
TKA series
UAT series

Connection N – oval for table top

Table connection for installing the cable routing underneath the table top or on a cable conduit via integrated magnets.

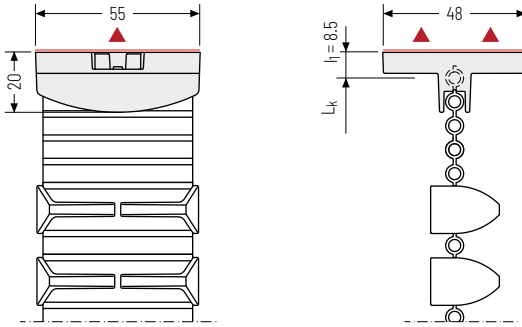
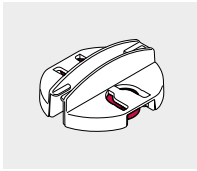
**Fixing variant**

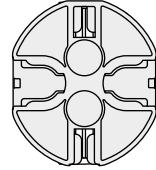

Magnets
Magnetic retention
force:
max. 35 N

▲ Installation options



 Self-adhesive counterholder available for non-magnetic surfaces!

Color variants

-  Black
Mat. no. 75937*
-  White
Mat. no. 75938*
-  Silver-gray
Mat. no. 75939*

*SU = 50 pieces

Side parts „Clip“ – Fixing kit for connection on both sides

Connection for installing the cable routing and attachments such as connector strips, adapters and much more. Fixing with integrated magnets or screws.

▲ Installation options

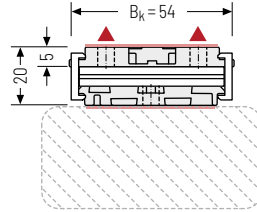
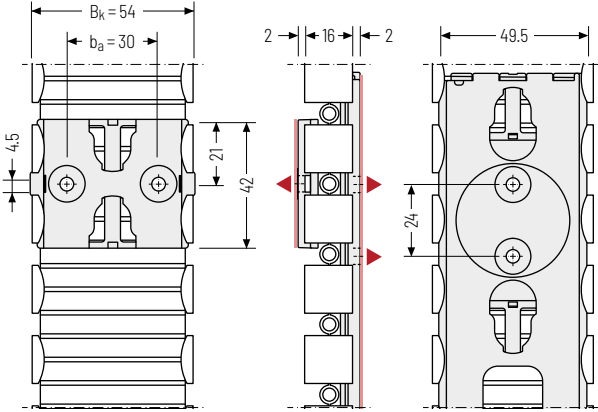

i Self-adhesive counterholder available for non-magnetic surfaces!

The fixing kit includes the belt and the side parts "Clip" for a length of 480 mm. The side parts "Clip" can be combined with the following connectors:

Color variants

- Black
Mat. no. 75815*
- White
Mat. no. 75817*
- Silver-gray
Mat. no. 75816*

* Length: 480 mm

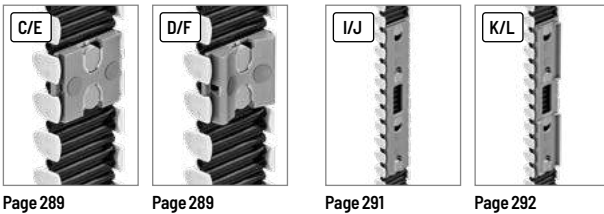

Page 289

Page 289

Page 291

Page 292

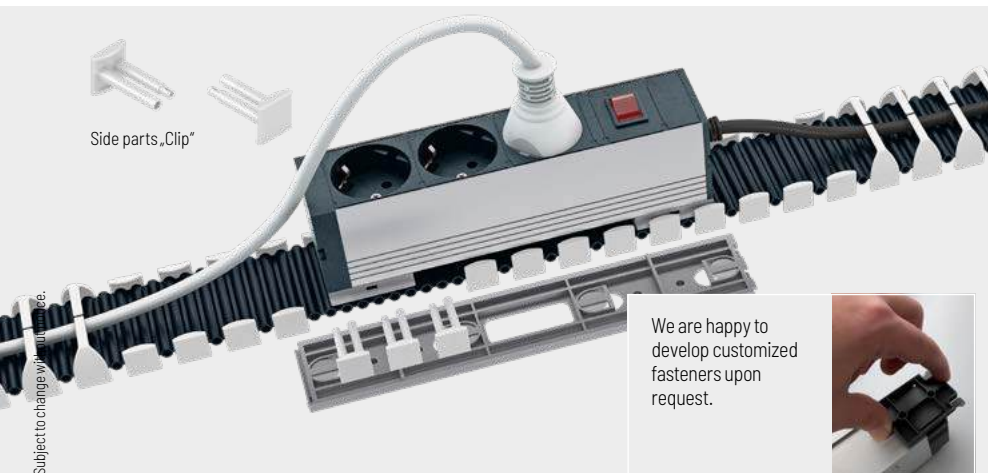

Side parts „Clip“

We are happy to develop customized fasteners upon request.



Subject to change without notice.

PROTUM® series
K series
UNIFLEX Advanced series
M series
XL series
QUANTUM® series
TKR series
TKA series
UAT series

K
series

UNIFLEX
Advanced
series

M
series

XL
series

QUANTUM®
series

TKR
series





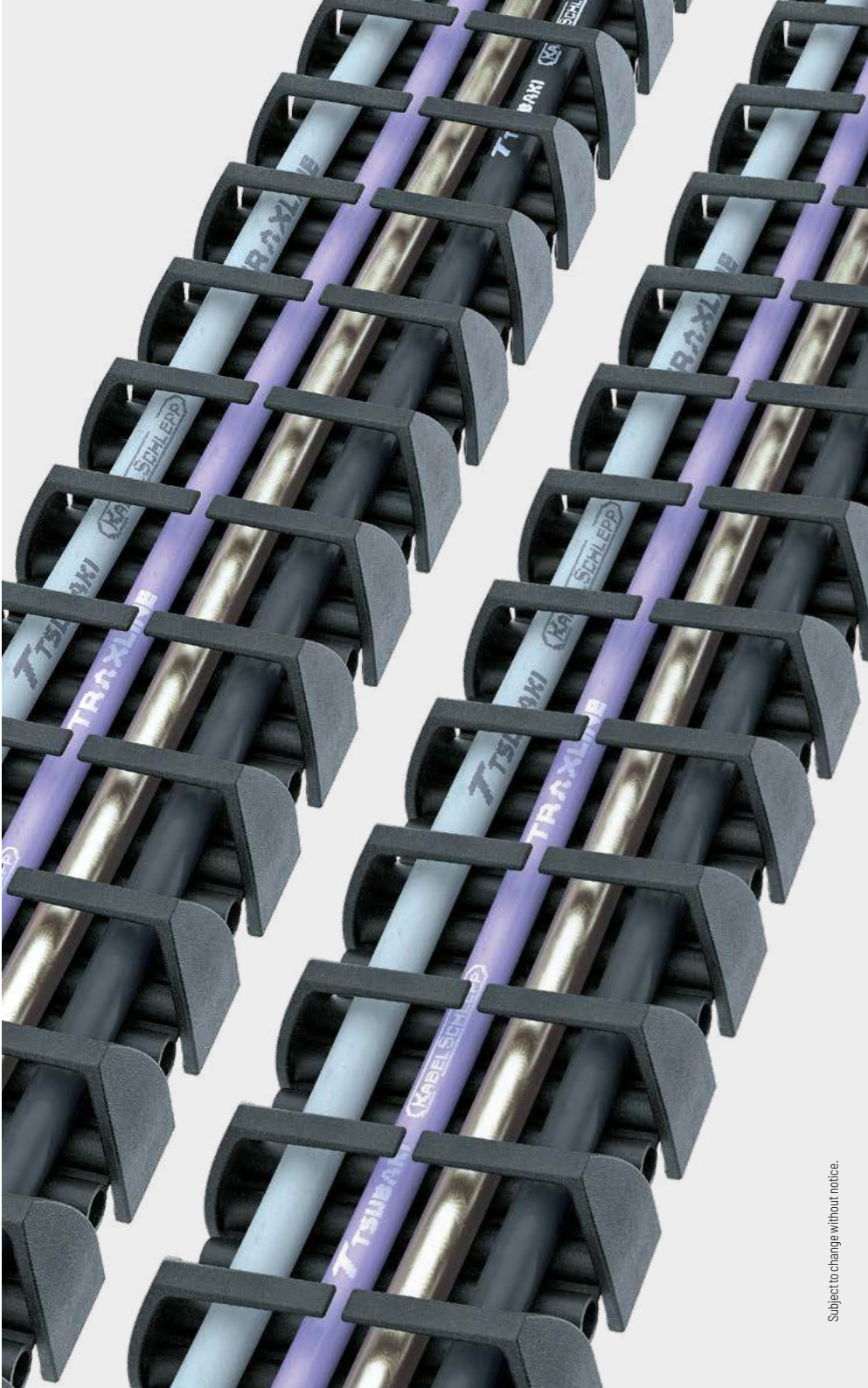

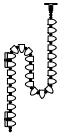

TKA
series

UAT
series

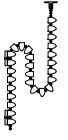

Order





Standard sets for height-adjustable tables (standing/seated work stations) up to 740 mm lifting height

		Color	Order no. Set
	Standard set Protum Office P0240GS for standing/seated work station for one-sided cable laying , total length 1350 mm incl. 1 connection B and 2 connections F for installation underneath a table top and on a round table frame (D = 70 mm)	 Black	75905
		 White	75907
		 Silver-gray	75906
	Standard set Protum Office P0240GS for standing/seated work station for one-sided cable laying , total length 1350 mm incl. 1 connection B and 2 connections E for installation underneath a table top and on a flat table frame	 Schwarz	75901
		 White	75903
		 Silver-gray	75902



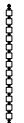

Standard sets for non-height adjustable tables (standard work stations)

		Color	Order no. Set
	Standard set Protum Office P0240GS for standard work station for one-sided cable laying , total length 815 mm incl. 1 connection B and 1 connection C for installation underneath a table top and the floor transition	 Black	75896
		 White	75898
		 Silver-gray	75897

Standard sets for attaching a power strip

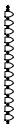
		Color	Order no. Set
	Standard set of "Clip" side parts for attaching a power strip . Fastening set for attaching on both sides . Total length 480 mm.	 Black	75815
		 White	75817
		 Silver-gray	75816

Standard sets for cable routing P0240GS

		Color	Order no. Set
	Standard set for cable routing Protum Office P0240GS , inner cross section 50 x 10 mm, total length 960 mm.	 Black	75637
		 White	75645
		 Silver-gray	75641

All sets are delivered packaged in a box including fixing materials and installation instructions. The order number applies for 1 set / 1 sales unit (SU) = 50 sets. Individual sets only for bulk buyers on request.

 Colored items may have color differences.

PROTUM®
series

K
series

UNIFLEX
Advanced
series

M
series

XL
series

QUANTUM®
series

TKR
series

TKA
series

UAT
series

P0400 GS

PROTUM OFFICE



Pitch
40 mm



Inner height
21.5 mm



Inner width
50 - 52 mm

This variant for office use is based on the PROTUM® cable carrier system. With an inner width of 50 mm and cable installation on both sides, PROTUM OFFICE offers sufficient space for telecommunication, energy and data cables in modern offices.

The linkless design can blend into the environment as a design element, e.g. with an elegant silver-grey optic.

Small, light cable carrier

- » Long service life - no links and therefore no link wear
- » Easy to install and fill
- » Suitable for retrofitting
- » Clean, space-saving installation
- » Can be filled on one or both sides

Easy and fast installation

- » Standard connection for table frame, round and square outside the footwell
- » Up to 4 installation options, depending on connection (magnets, screws, cable ties and adhesive tape)
- » Floor connection for sturdy positioning and floor connection

Stay variants



P0400GS01 (one-sided) page 284

Frame with lamellae in the outer radius

- » Belt with clip-on side parts.
- » **One-sided:** for pressing in.



P0400GS02 (double-sided) page 284

Frame with lamellae in the outer and inner radius

- » Belt with clip-on side parts.
- » **Double-sided:** for pressing in.



P0400GS01.X (Module combination) page 285

Frame with lamellae in the outer radius

- » Belt with clip-on side parts.
- » **One-sided:** for pressing in.



Stay variant 010 – with lamellae in the outer or outer and inner radius

- » Belt with clip-on side parts.
- » **One-sided/Double-sided:**
for pressing in.

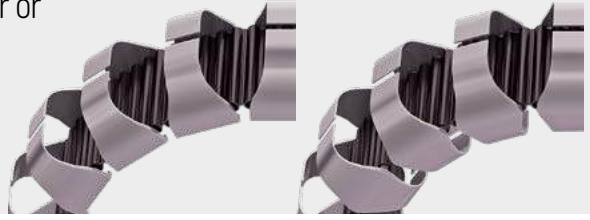

 Stay arrangement on each
chain link (**fully stayed**)

 B_i 50 mm

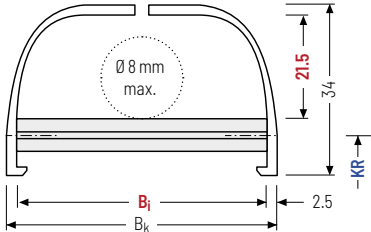
P0400GS01

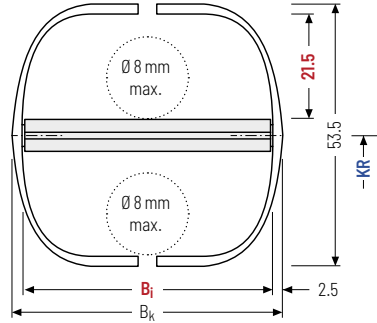

P0400GS02



Design	h_i [mm]	h_G [mm]	B_i [mm]	B_k [mm]	q_k [kg/m]
P0400GS01 (one-sided)	21.5	34	50	$B_i + 5$	0.286
P0400GS02 (double-sided)	21.5	53.5	50	$B_i + 5$	0.336

Standard colours

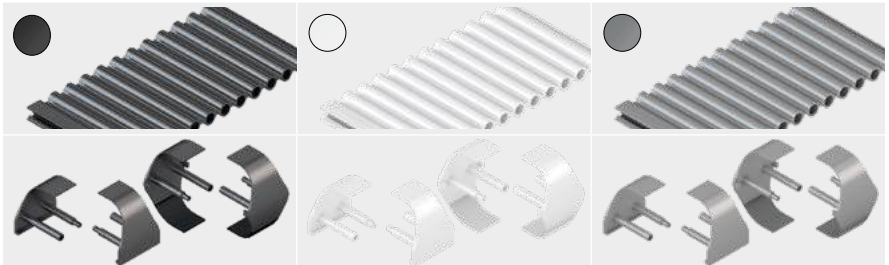
 Black (RAL 9005)
 P0400GS01 Mat. no. 75972*
 P0400GS02 Mat. no. 75981*

 White (RAL 9010)
 P0400GS01 Mat. no. 75980*
 P0400GS02 Mat. no. 75989*

 Silver-grey (RAL 9023)
 P0400GS01 Mat. no. 75976*
 P0400GS02 Mat. no. 75985*

For bulk buyers, the colour variants of the belt, the side parts and the connections can be individually combined on request. Colored items may have color differences.

* Length: 960 mm

Stay variant 010 Module combination – with lamellae in the outer radius

- » Belt with clip-on side and middle parts.
- » Modules can be combined with one another as required.
- » **One-sided:** for pressing in.

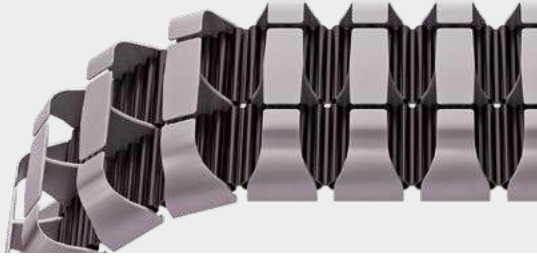

Stay arrangement on each chain link (**fully stayed**)



B_1 51/52 mm

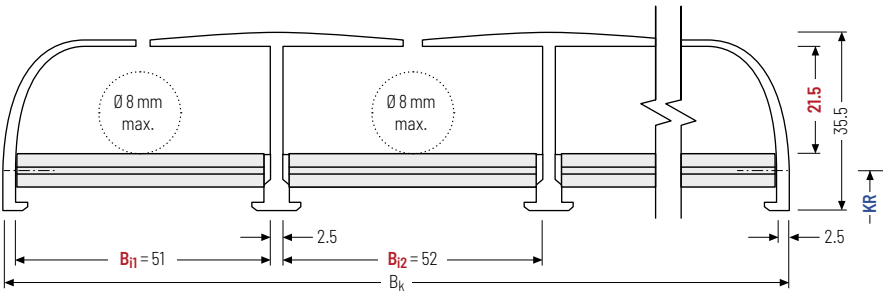

Design	Chamber	h_i [mm]	h_G [mm]	B_i [mm]	B_k [mm]	q_k [kg/m]
P0400GS01.2	2	21.5	35.5	2x51	109.5	0.608
P0400GS01.3	3	21.5	35.5	2x51 + 1x52	164.0	0.911
P0400GS01.4	4	21.5	35.5	2x51 + 2x52	218.5	1.215
P0400GS01.5	5	21.5	35.5	2x51 + 3x52	273.0	1.519

Standard colours

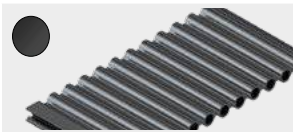

Black (RAL 9005)
P0400GS01.2 Mat. no. 75855*



White (RAL 9010)
P0400GS01.2 Mat. no. 75857*



Silver-grey (RAL 9023)
P0400GS01.2 Mat. no. 75856*

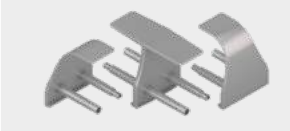

For bulk buyers, the colored variants of the belt, the side parts and the connections, as well as the modules can be individually combined on request. Colored items may have color differences.

* Length: 960 mm

Combination options for end connectors

Depending on the design of your office furniture, different combination options are possible for the end connectors. They can be attached underneath table tops/cable conduits, to round or square table legs or to the floor.

Combination options for tables without height adjustment

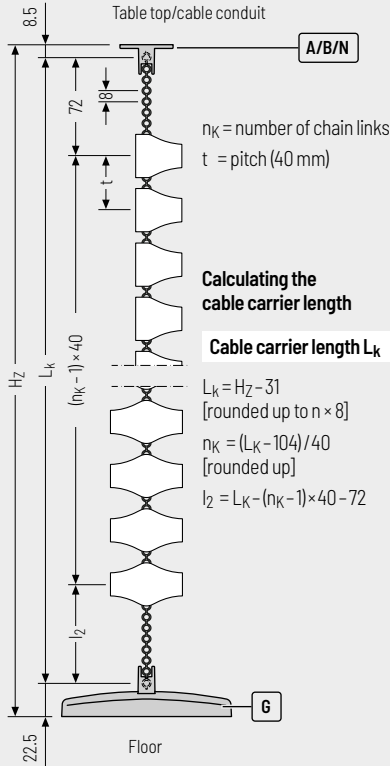

Combination options for tables with height adjustment (only one-sided variant)

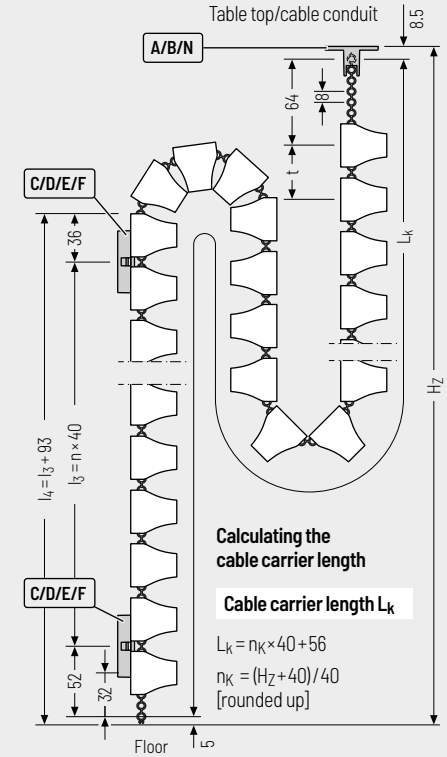

End connectors

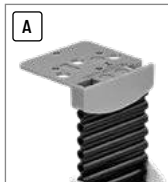

Page 288



Page 288



Page 289



Page 289



Page 290



All connections and cable carriers can be combined with each other and are available in the colour variants silver-grey, black and white.

Combination options for end connectors

Depending on the design of your office furniture, different combination options are possible for the end connectors. They can be attached underneath table tops/cable conduits, to round or square table legs or to the floor.

Combination options for tables with height adjustment (only one-sided variant)

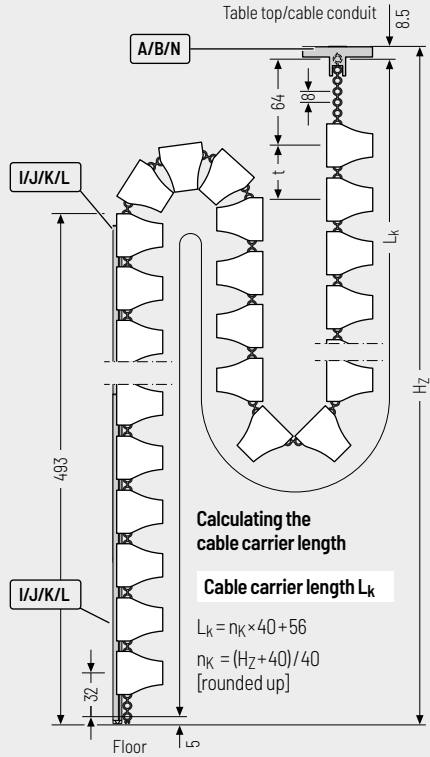
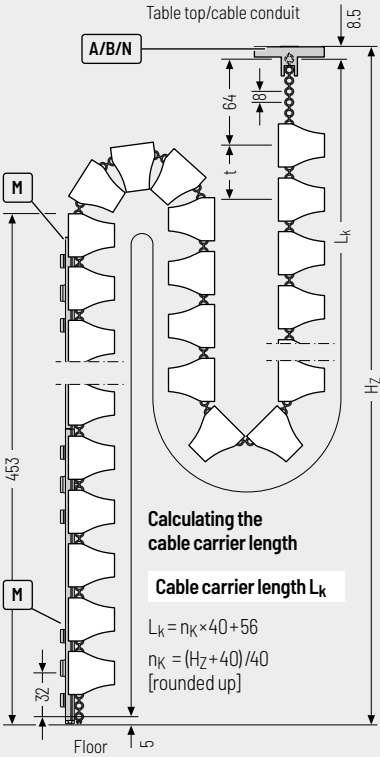

End connectors

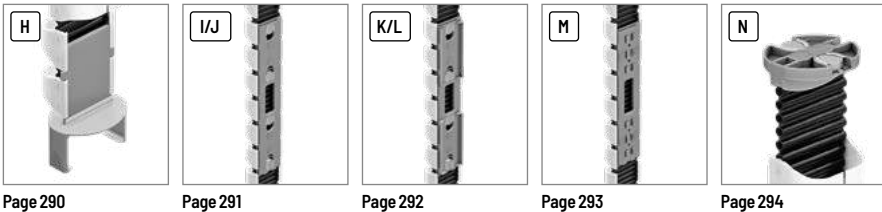

Page 290

Page 291

Page 292

Page 293

Page 294

Subject to change without notice.

All connections and cable carriers can be combined with each other and are available in the colour variants silver-grey, black and white.

PROTUM® series

K series

UNIFLEX Advanced series

M series

XL series

QUANTUM® series

TKR series

TKA series

UAT series

PROTUM®
seriesK
seriesUNIFLEX
Advanced
seriesM
seriesXL
seriesQUANTUM®
seriesTKR
seriesTKA
seriesUAT
series**Connection A** – angled for table top

Table connection for screw-fixing the cable routing underneath the table top or on a cable conduit.

▲ Installation options

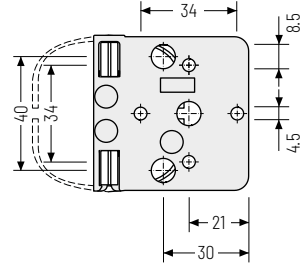
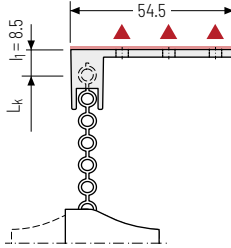
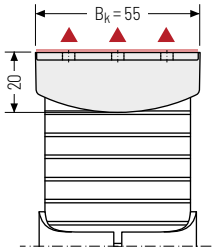
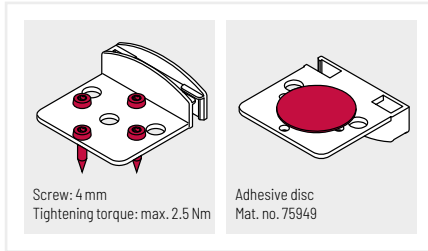
**Fixing variant****Color variants**

- Black
Mat. no. 75739*
- White
Mat. no. 75884*
- Silver-gray
Mat. no. 75876*

*SU = 50 pieces

Connection B – oval for table top

Table connection for screw-fixing the cable routing underneath the table top or on a cable conduit.

▲ Installation options

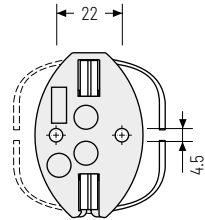
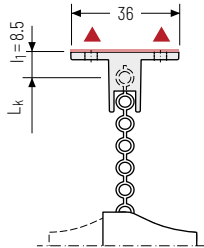
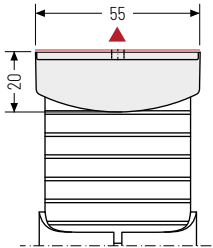
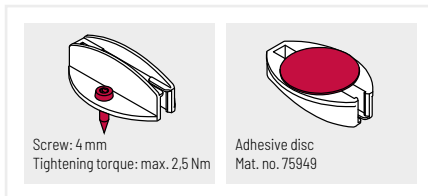
**Fixing variant****Color variants**

- Black
Mat. no. 75740*
- White
Mat. no. 75885*
- Silver-gray
Mat. no. 75877*

*SU = 50 pieces



Also available as magnetic version (Connector N) see p. 278

Connection C/E – for flat table frame

Connection for installing the cable routing on a square table frame. Fixing with integrated magnets, screws or cable ties.

▲ Installation options

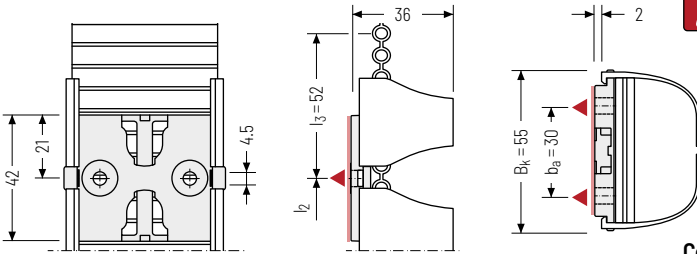

 Self-adhesive counterholder available for non-magnetic surfaces!

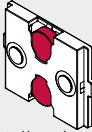
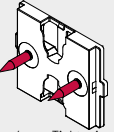
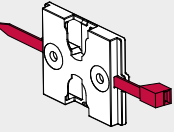

Fixing variants

<p>Connection E</p>  <p>Magnets, Magnetic retention force: max. 40 N</p>	<p>Connection C</p>  <p>Screw: 4 mm, Tightening torque: max. 2.5 Nm</p>	<p>Connection C</p>  <p>Cable tie: 5 mm</p>
--	---	---

Color variants

-  Black (E) Mat. no. 75741* (C) Mat. no. 75742*
-  White (E) Mat. no. 75886* (C) Mat. no. 75887*
-  Silver-gray (E) Mat. no. 75878* (C) Mat. no. 75879*

*SU=50 pieces

Connection D/F – for round table frame

Connection for installing the cable routing on a table frame with 70 mm diameter. Fixing with integrated magnets, screws or cable ties.

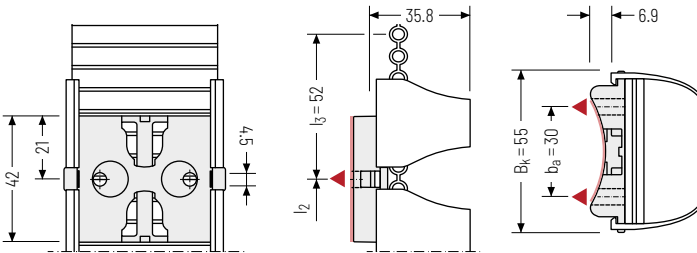

▲ Installation options

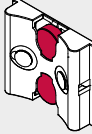
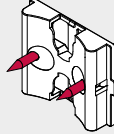
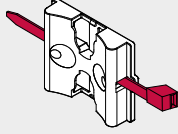

Fixing variants

<p>Connection F</p>  <p>Magnets, Magnetic retention force: max. 40 N</p>	<p>Connection D</p>  <p>Screw: 4 mm, Tightening torque: max. 2.5 Nm</p>	<p>Connection D</p>  <p>Cable tie: 5 mm</p>
--	---	---

Color variants

-  Black (F) Mat. no. 75744* (D) Mat. no. 75743*
-  White (F) Mat. no. 75888* (D) Mat. no. 75889*
-  Silver-gray (F) Mat. no. 75880* (D) Mat. no. 75881*

*SU=50 pieces

PROTUM® series	K series
UNIFLEX Advanced series	K series
M series	K series
XL series	K series
QUANTUM® series	K series
TKR series	K series
TKA series	K series
UAT series	K series

Connection G – floor connection

Floor connection for a clean transition of the cable routing to the floor.
Individual colors and designs on request.

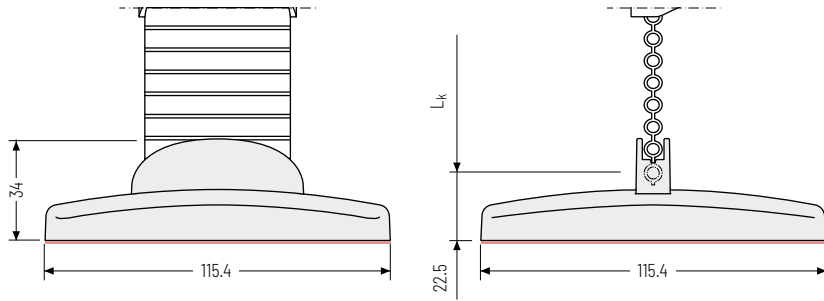
**Color variants**

Black
Mat. no. 75745*



White
Mat. no. 75890*



Silver-gray
Mat. no. 75882*

*SU = 50 pieces

Connection H – for table base

Connection for installing the cable routing on a table base.
Fixing by clipping.

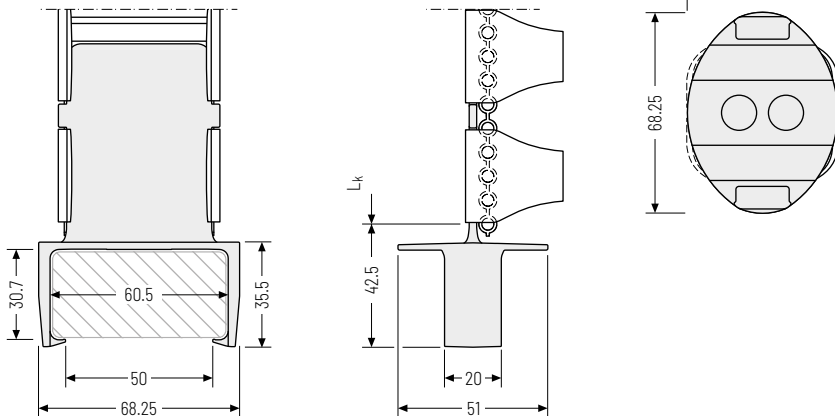
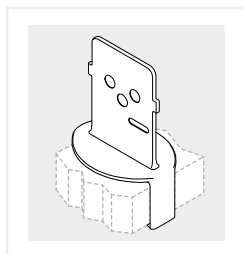
**Fixing variant****Color variants**

Black
Mat. no. 75992*



White
Mat. no. 75994*



Silver-gray
Mat. no. 75993*

*SU = 50 pieces

Connection I/J - for flat table frame

Connection for installing the cable routing on a square table frame.
Fixing with integrated magnets or screws.

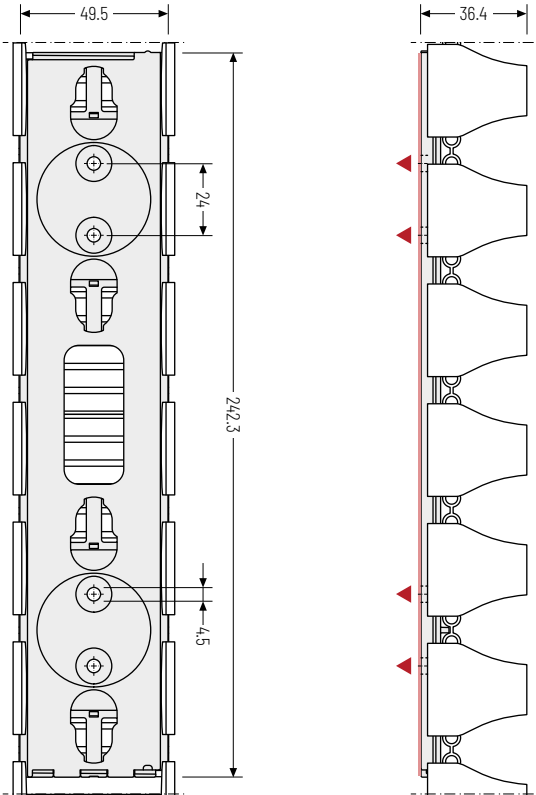

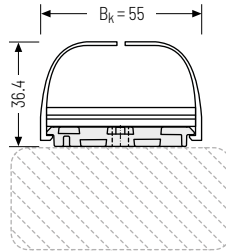

▲ Installation options



 Self-adhesive counterholder available for non-magnetic surfaces!

Color variants

-  Black
(I) Mat. no. 75940*
(J) Mat. no. 75634*
-  White
(I) Mat. no. 75941*
(J) Mat. no. 75635*
-  Silver-gray
(I) Mat. no. 75942*
(J) Mat. no. 75636*

*SU = 50 pieces

Fixing variants

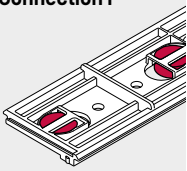
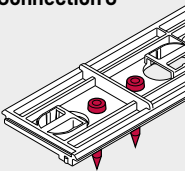
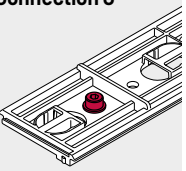
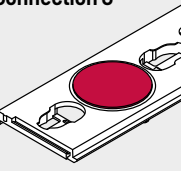
<p>Connection I</p>  <p>Up to 4 magnets, Magnetic retention force: min. 60 N</p>	<p>Connection J</p>  <p>Up to 4 Screws: 4 mm Tightening torque: max. 2.5 Nm</p>	<p>Connection J</p>  <p>For slot nut M4 Cylinder screw: DIN 9612 M4 Washer: DIN 125</p>	<p>Connection J</p>  <p>Adhesive disc Mat. no. 75949</p>
--	---	---	--

Subject to change without notice.

PROTUM® series
K series
UNIFLEX Advanced series
M series
XL series
QUANTUM® series
TKR series
TKA series
UAT series

Connection K/L - for round table frame

Connection for installing the cable routing on a table frame with 70 mm diameter. Fixing with integrated magnets or screws.

▲ Installation options

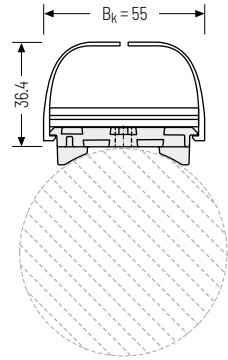
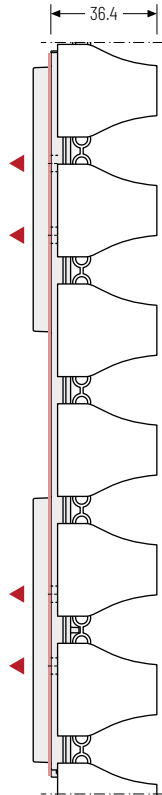
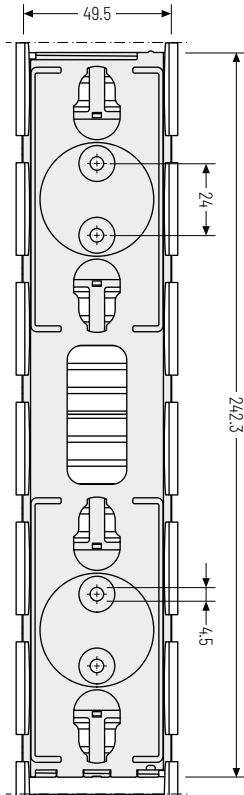

Individual diameters on request.

Color variants

- Black
(K) Mat. no. 75943*
(L) Mat. no. 75647*
- White
(K) Mat. no. 75944*
(L) Mat. no. 75648*
- Silver-gray
(K) Mat. no. 75945*
(L) Mat. no. 75649*

*SU = 50 pieces

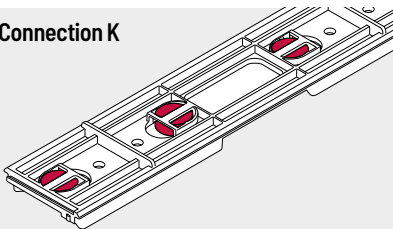
Fixing variants**Connection K**

Up to 4 magnets
Magnetic retention force: min. 60 N

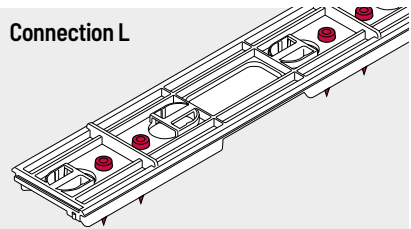
Connection L

Up to 4 Screws: 4 mm
Tightening torque: max. 2.5 Nm

Connection M – for profiles flat

Connection for installing the cable routing on aluminum profiles rectangular.
Fixing via integrated clip.

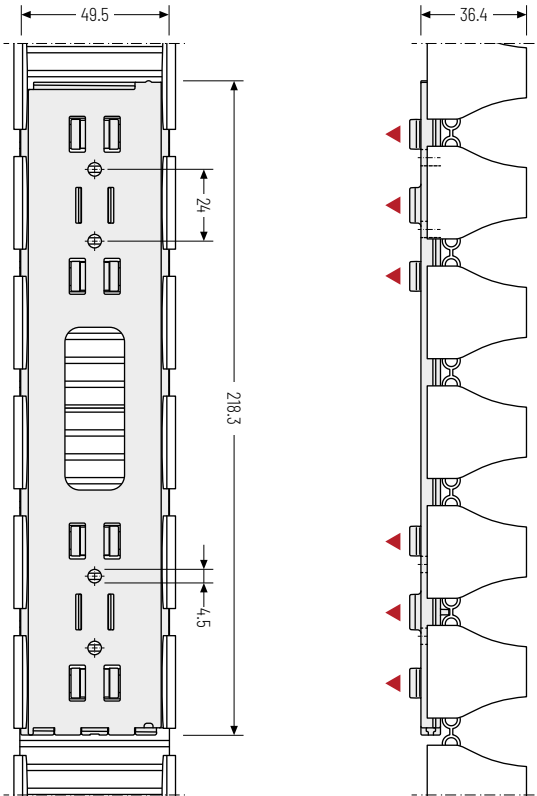

▲ Installation options

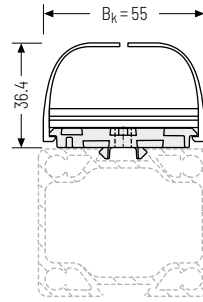

i Individual profile cross-section on request.

Color variants

- Black
Mat. no. 75937*
- White
Mat. no. 75938*
- Silver-gray
Mat. no. 75939*

*SU = 50 pieces

Fixing variant

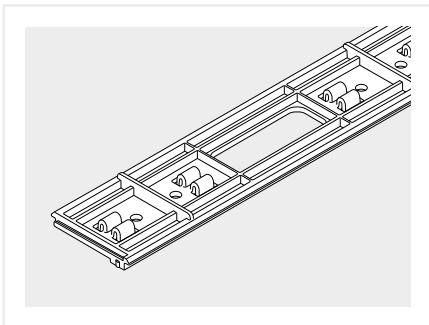

i The assembly depends on the shape of the aluminum profile. Please contact us – we are happy to advise you

Connection N – oval for table top

Table connection for installing the cable routing underneath the table top or on a cable conduit via integrated magnets.

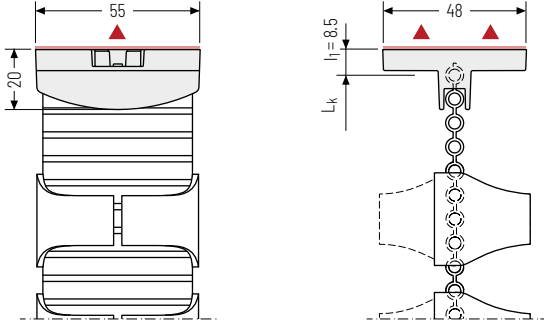

▲ Installation options

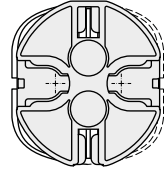

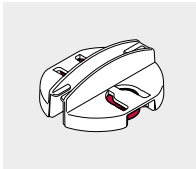

 Self-adhesive counterholder available for non-magnetic surfaces!

Fixing variant

Magnets
Magnetic retention
force:
max. 35 N

Color variants

-  Black
Mat. no. 75937*
-  White
Mat. no. 75938*
-  Silver-gray
Mat. no. 75939*

*SU = 50 pieces

Side parts „Clip“ – Fixing kit for connection on both sides

Connection for installing the cable routing and attachments such as connector strips, adapters and much more. Fixing with integrated magnets or screws.

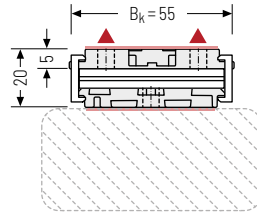
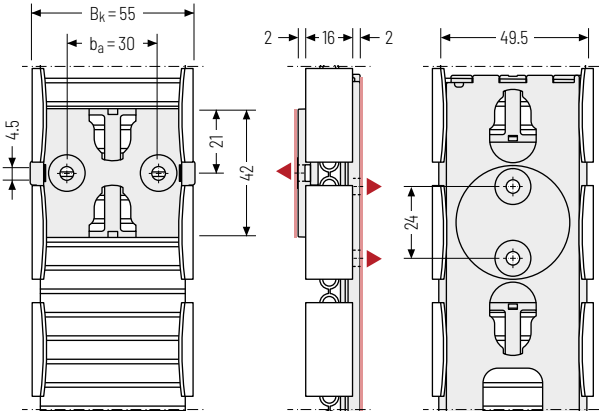

▲ Installation options



 Self-adhesive counterholder available for non-magnetic surfaces!

The fixing kit includes the belt and the side parts "Clip" for a length of 480 mm. The side parts "Clip" can be combined with the following connectors:

Color variants

-  Black
Mat. no. 75812*
-  White
Mat. no. 75814*
-  Silver-grey
Mat. no. 75813*

* Length: 480 mm

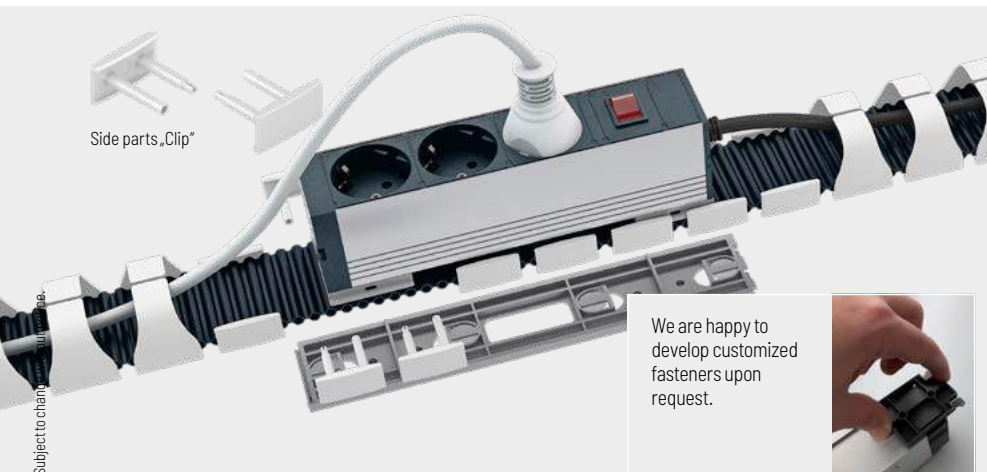
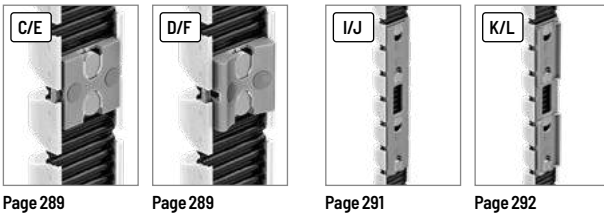

Side parts „Clip“

We are happy to develop customized fasteners upon request.



PROTUM® series
K series
UNIFLEX Advanced series
M series
XL series
QUANTUM® series
TKR series
TKA series
UAT series

Subject to change without notice.

Order

Standard sets for height-adjustable tables (standing/seated work stations)
up to 740 mm lifting height

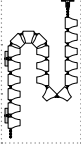
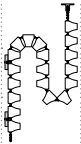
		Color	Order no. Set
	Standard set Protum Office P0400GS01 for standing/seated work station for one-sided cable laying , total length 1350 mm incl. 1 connection B and 2 connections F for installation underneath a table top and on a round table frame (D=70 mm)	<input checked="" type="radio"/> Black	75968
		<input type="radio"/> White	75970
		<input type="radio"/> Silver-gray	75969
	Standard set Protum Office P0400GS01 for standing/seated work station for one-sided cable laying , total length 1350 mm incl. 1 connection B and 2 connections E for installation underneath a table top and on a flat table frame	<input checked="" type="radio"/> Black	75964
		<input type="radio"/> White	75966
		<input type="radio"/> Silver-gray	75965

Standard sets for non-height adjustable tables (standard work stations)

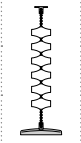
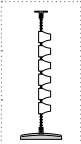
		Color	Order no. Set
	Standard set Protum Office P0400GS02 for standard work station for double-sided cable laying , total length 815 mm incl. 1 connection B and 1 connection G for installation underneath a table top and the floor transition	<input checked="" type="radio"/> Black	75960
		<input type="radio"/> White	75962
		<input type="radio"/> Silver-gray	75961
	Standard set Protum Office P0400GS01 for standard work station for one-sided cable laying , total length 815 mm incl. 1 connection B and 1 connection G for installation underneath a table top and the floor transition	<input checked="" type="radio"/> Black	75956
		<input type="radio"/> White	75958
		<input type="radio"/> Silver-gray	75957

Standard sets for attaching a power strip

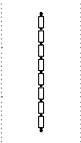
		Color	Order no. Set
	Standard set of "Clip" side parts for attaching a power strip . Fastening set for attaching on both sides . Total length 480 mm.	<input checked="" type="radio"/> Black	75835
		<input type="radio"/> White	75837
		<input type="radio"/> Silver-gray	75836

PROTUM®
seriesK
seriesUNIFLEX
Advanced
seriesM
seriesXL
seriesQUANTUM®
seriesTKR
seriesTKA
seriesUAT
series

Order

Standard sets for cable routing P0400GS01

		Color	Order no. Set
	Standard set for cable routing Protum Office P0400GS01 , inner cross section 50 x 21,5 mm, total length 960 mm.	Black	75972
		White	75980
		Silver-gray	75976

Standard sets for cable routing P0400GS01.2

		Color	Order no. Set
	Standard set for cable routing Protum Office P0400GS01.2 , inner cross section 2 x (51 x 21,5 mm), total length 960 mm.	Black	75855
		White	75857
		Silver-gray	75856

Standard sets for cable routing P0400GS02

		Color	Order no. Set
	Standard set for cable routing Protum Office P0400GS02 , inner cross section 2 x (50 x 21,5 mm), total length 960 mm.	Black	75981
		White	75989
		Silver-gray	75985

All sets are delivered packaged in a box including fixing materials and installation instructions. The order number applies for 1 set / 1 sales unit (SU) = 50 sets. Individual sets only for bulk buyers on request.

Colored items may have color differences.



page without notice.

PROTUM®
series

K
series

UNIFLEX
Advanced
series

M
series

XL
series

QUANTUM®
series

TKR
series

TKA
series

UAT
series

PROTUM®
seriesK
seriesUNIFLEX
Advanced
seriesM
seriesXL
seriesQUANTUM®
seriesTKR
seriesTKA
seriesUAT
series

VARIO-LINE

Cable carriers with variable chain widths

The product types from the VARIO-LINE offer great variability for cable carrier widths and separation options within the cable carrier. This allows reliable and efficient partitioning even for complex cable configurations. Hoses and cables with larger diameters can also be accommodated and guided.

- » Aluminum stays available in 1 mm width sections
- » Plastic stays available in 4, 8 or 16 mm width sections (depending on type)
- » Easy and quick to open inside and outside
- » Light, extremely robust or linkless series
- » Cable carriers for complex applications



K series Page **300**

Cost-effective, robust cable carrier – suitable for large additional loads

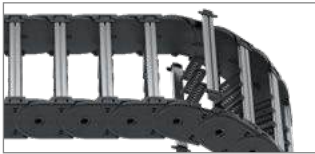

UNIFLEX Advanced series Page **336**

Light and quiet all-rounder



M series Page **350**

Variable cable carrier with extensive accessories and stay variants

PROTUM®
seriesK
seriesUNIFLEX
Advanced
seriesM
seriesXL
seriesQUANTUM®
seriesTKR
seriesTKA
seriesUAT
series**XL series** Page **476**

Cable carrier with large inside height

**QUANTUM® series** Page **486**Light, extremely quiet and low-vibration
for high speeds and accelerations**TKR series** Page **534**Extremely quiet and low-vibration
for highly dynamic applications

K series

**Cost-effective, robust cable carrier –
suitable for large additional loads**

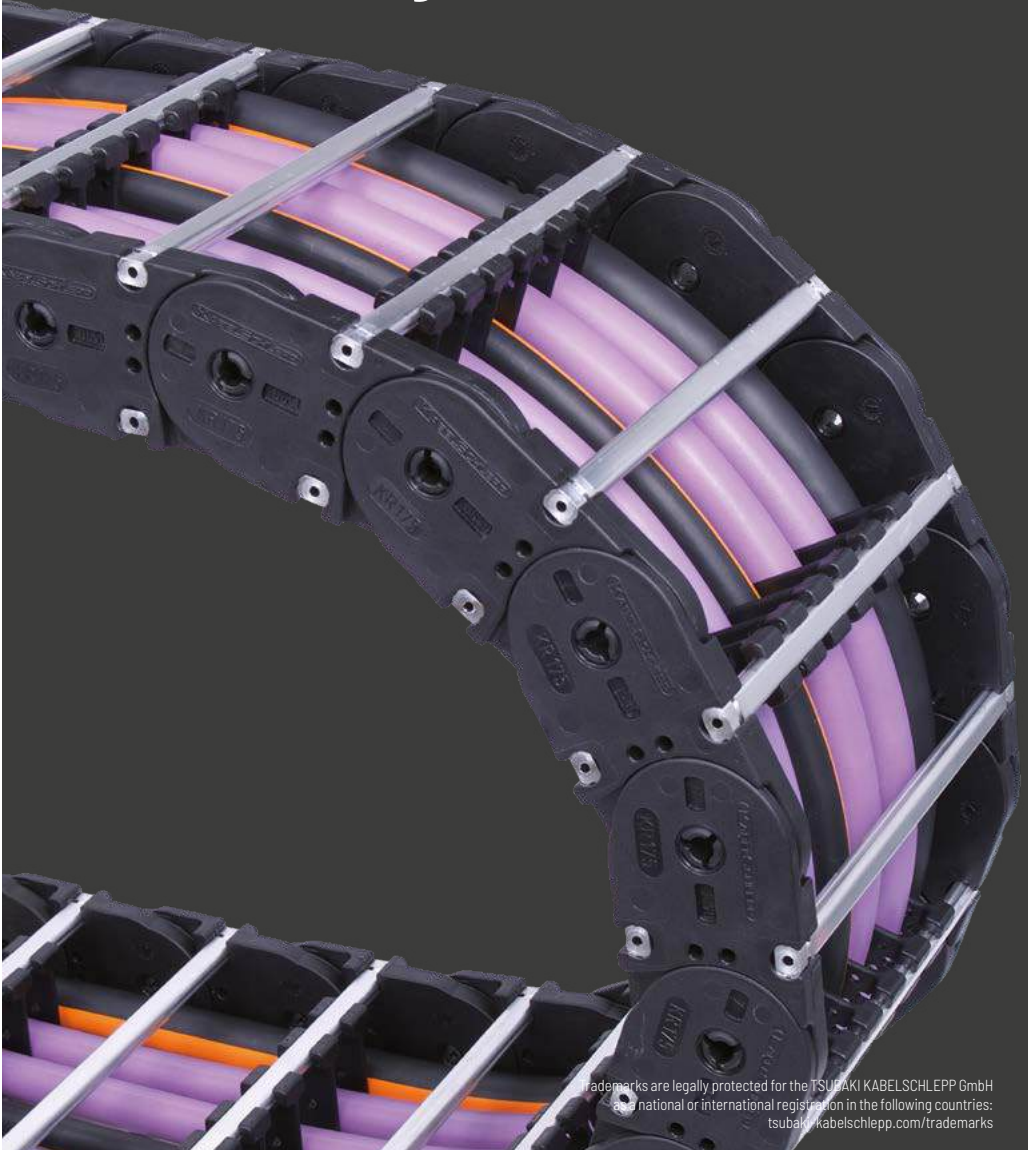

Trademarks are legally protected for the TSUBAKI KABELSCHLEPP GmbH
national or international registration in the following countries:
tsubaki-kabelschlepp.com/trademarks

Subject to change without notice.

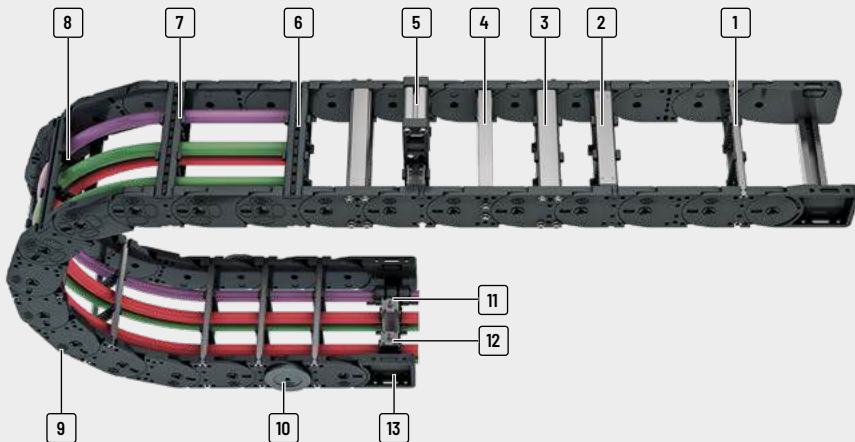

- | | | | |
|---|---|---|---|
| <p>1 Aluminum stays available in 1 mm width sections</p> <p>2 Aluminum stays in reinforced version</p> <p>3 Aluminum stays with 4 screw-fixing points for extreme loads</p> | <p>4 Aluminum hole stays</p> <p>5 Mounting frame stays</p> <p>6 Plastic stays available in 8 or 16 mm width sections</p> <p>7 Can be opened quickly on the inside and the outside for cable laying</p> | <p>8 Fixable dividers</p> <p>9 Molded slide runners</p> <p>10 Slide discs</p> <p>11 C-rail for strain relief elements</p> <p>12 Strain relief elements</p> | <p>13 Universal end connectors (UMB)</p> |
|---|---|---|---|

Features

- » Stable sidebands through robust link plate design
- » Encapsulated, dirt-resistant stroke system
- » Long service due to minimized hinge wear owing to the "life extending 2 disc principle"
- » Versions with aluminum stays available in 1 mm width sections up to 700 mm inner width
- » Versions with plastic stays available in 8 or 16 mm width sections
- » Large selection of vertical and horizontal stay separation options for your cables

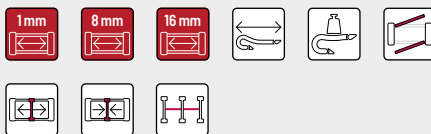

Minimized hinge wear owing to the "life extending 2 disc principle"















Slide discs for long service life for applications where the carrier is rotated through 90°



Molded slide runners for long service life in sliding arrangement



Many separation options for the cables

Type	Opening variant	Stay variant	h_i	h_G	B_i	B_k	B_i -grid	t	KR	Additional load \leq [kg/m]	Cable- d_{max} [mm]
			[mm]	[mm]	[mm]	[mm]	[mm]	[mm]	[mm]		
K0650											
		RS	38	57.5	75 - 400	103 - 428	1	65	75 - 300	20	30
		LG	36	57.5	75 - 600	103 - 628	1	65	75 - 300	20	32
		RMA	38 (200)	57.5 (224)	200 - 400	234 - 428	1	65	75 - 300	20	160
		RE	42	57.5	68 - 268	96 - 296	8	65	75 - 300	20	33
K0900											
		RS	58	78.5	100 - 400	131 - 431	1	90	130 - 385	30	46
		RV	58	78.5	100 - 500	131 - 531	1	90	130 - 385	30	46
		RM	54	78.5	100 - 600	131 - 631	1	90	130 - 385	30	43
		LG	50	78.5	100 - 700	131 - 731	1	90	130 - 385	30	42
		RMA	58 (200)	78.5 (224)	200 - 500	231 - 531	1	90	130 - 385	30	160
		RMR	51	78.5	100 - 600	131 - 631	1	90	130 - 385	30	41
	RE	58	78.5	81 - 561	112 - 592	16	90	130 - 385	30	46	

* Further information on request.

PROTUM®
seriesK
seriesUNIFLEX
Advanced
seriesM
seriesXL
seriesQUANTUM®
seriesTKR
seriesTKA
seriesUAT
series

Unsupported arrangement			Gliding arrangement			Inner Distribution				Movement			Page
Travel length ≤ [m]	v_{max} ≤ [m/s]	a_{max} ≤ [m/s ²]	Travel length ≤ [m]	v_{max} ≤ [m/s]	a_{max} ≤ [m/s ²]	TS0	TS1	TS2	TS3	vertical hanging or standing	lying on the side	rotating arrangement	
4.8	8	40	220	2	3	•	•	•	•	•	•	•	306
4.8	8	40	220	2	3	-	-	-	-	•	•	•	310
4.8	8	40	220	2	3	•	-	-	-	•	•	-	312
4.8	8	40	220	2	3	•	•	-	•	•	•	•	314
8.4	6	30	260	2	3	•	•	•	•	•	•	•	320
8.4	6	30	260	2	3	•	•	•	•	•	•	•	324
8.4	6	30	260	2	3	•	•	-	-	•	•	•	*
8.4	6	30	260	2	3	-	-	-	-	•	•	•	328
8.4	6	30	260	2	3	•	-	-	-	•	•	-	330
8.4	6	30	260	2	3	•	-	-	-	•	•	•	*
8.4	6	30	260	2	3	•	•	•	•	•	•	•	332

PROTUM® series

K series

UNIFLEX Advanced series

M series

XL series

QUANTUM® series

TKR series

TKA series

UAT series

K0650



Pitch
65 mm



Inner heights
36 - 42 mm



Inner widths
68 - 400 mm



Bending radii
75 - 300 mm

Stay variants



Aluminum stay RS page **306**

Frame stay, narrow "The standard"

- » Aluminum profile bars for light to medium loads. Assembly without screws.
- » **Outside/inside:** to open by rotating 90°.



Aluminum stay LG page **310**

Hole stay, split version

- » Optimum cable routing in the neutral bending line. Split version for easy cable routing. Stays also available unsplit.
- » **Outside/inside:** Screw-fixing easy to release.



Aluminum stay RMA page **312**

Mounting frame stay

- » Aluminum profile bars with plastic mounting frame stays for guiding very large cable diameters.
- » **Outside/inside:** Screw-fixing easy to release.



Plastic stay RE page **314**

Frame screw-in stay

- » Plastic profile bars for light to medium loads. Assembly without screws.
- » **Outside/inside:** to open by rotating 90°.

Unsupported arrangement

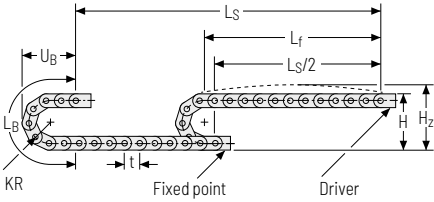





KR [mm]	H [mm]	H ₂ [mm]	L _B [mm]	U _B [mm]
75	205	245	366	168
115	285	325	492	208
145	345	385	586	238
175	405	445	680	268
220	495	535	822	313
300	655	695	1073	393

Load diagram for unsupported length depending on additional load.

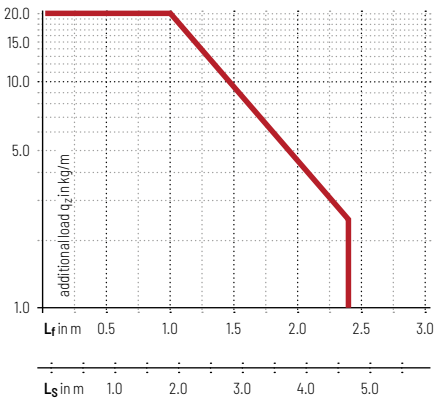
Sagging of the cable carrier is technically permitted for extended travel lengths, depending on the specific application.





Intrinsic cable carrier weight $q_k = 2.5 \text{ kg/m}$. For other inner widths, the maximum additional load changes.

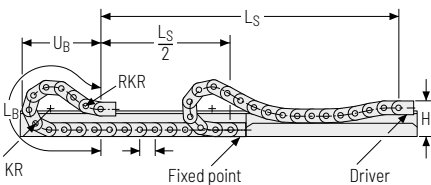

-  **Speed**
up to 8 m/s
-  **Acceleration**
up to 40 m/s^2
-  **Travel length**
up to 4.8 m
-  **Additional load**
up to 20 kg/m

Gliding arrangement



-  **Speed**
up to 2 m/s
-  **Acceleration**
up to 3 m/s^2
-  **Travel length**
up to 220 m
-  **Additional load**
up to 20 kg/m

 The gliding cable carrier must be guided in a channel. See p. 844.

If the cable carrier is positioned so it is rotated by 90° (gliding on the outside of the side band), slide discs snapped onto the side optimize the friction and wear situation.

PROTUM® series
K series
UNIFLEX Advanced series
M series
XL series
QUANTUM® series
TKR series
TKA series
UAT series

Aluminum stay RS – frame stay narrow

- » Extremely quick to open and close
- » Aluminum profile bars for light to medium loads. Assembly without screws.
- » Available customized in **1 mm width sections**.
- » **Outside/inside:** to open by rotating 90°.



Stay arrangement on every 2nd chain link, **standard (HS: half-stayed)**



Stay arrangement on each chain link (**VS: fully-stayed**)



1 mm B_i 75 – 400 mm in **1 mm width sections**

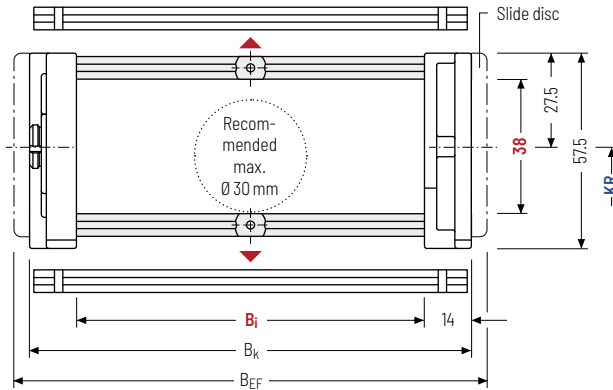

The maximum cable diameter strongly depends on the bending radius and the desired cable type. Please contact us.

Calculating the cable carrier length

Cable carrier length L_k

$$L_k \approx \frac{L_G}{2} + L_B$$

Cable carrier length L_k rounded to pitch t

h_i [mm]	h_G [mm]	B_i [mm]*	B_k [mm]	B_{EF} [mm]	KR [mm]					q_k [kg/m]	
38	575	75 - 400	$B_i + 28$	$B_i + 36$	75	115	145	175	220	300	1.87 - 3.60

* in 1 mm width sections

Order example



KC0650

Type

176

B_i [mm]

RS

Stay variant

115

KR [mm]

1430

L_k [mm]

HS

Stay arrangement

Divider systems

The divider system is mounted on each crossbar as a standard – on every 2nd chain link for stay mounting (HS – half-stayed).

For applications with lateral acceleration and rotated by 90°, the dividers can be attached by simply clipping on a socket (available as an accessory).

As a standard, dividers or the complete divider system (dividers with height separations) are movable in the cross section (**version A**).

This socket additionally acts as a spacer between the dividers and is available in a 1 mm grid between 3 – 50 mm. The inner height is reduced to 32 mm (**version B**).

Divider system TSO without height separation

Vers.	a _T min [mm]	a _x min [mm]	a _c min [mm]	n _T min
A	6,5	13	10	2

The dividers can be moved in the cross section.

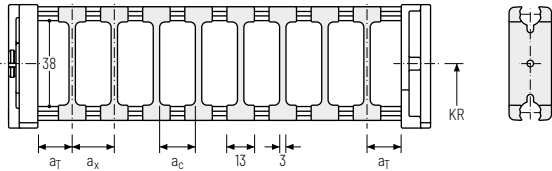

Divider system TS1 with continuous height separation

Vers.	a _T min [mm]	a _T max [mm]	a _x min [mm]	a _c min [mm]	n _T min
A	6,5	25	13	10	2

The dividers can be moved in the cross section.

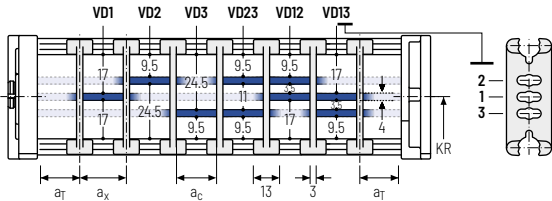

Divider system TS2 with partial height separation

Vers.	a _T min [mm]	a _x min [mm]	a _c min [mm]	n _T min
A	3,5	21	15	2

With grid distribution (1 mm grid). The dividers are attached by the height separation, the grid can be moved in the cross section.

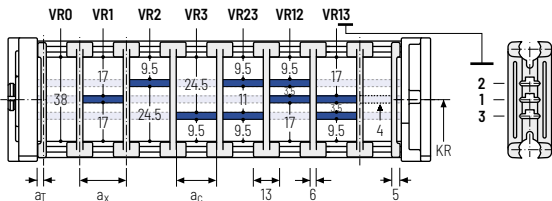

Sliding dividers are optionally available (thickness of divider = 3 mm).

PROTUM® series

K series

UNIFLEX Advanced series

M series

XL series

QUANTUM® series

TKR series

TKA series

UAT series

Additional product information online



Installation instructions, etc.: Additional info via your smartphone or check online at tsubaki-kabelschlepp.com/downloads



Configure your cable carrier here: online-engineer.de

Divider system TS3 with height separation consisting of plastic partitions

Vers.	a_T min [mm]	a_x min [mm]	a_c min [mm]	n_T min
A	4	16 / 42*	8	2

* For aluminum partitions

The dividers are fixed by the partitions, the complete divider system is movable in the cross section.

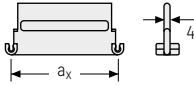
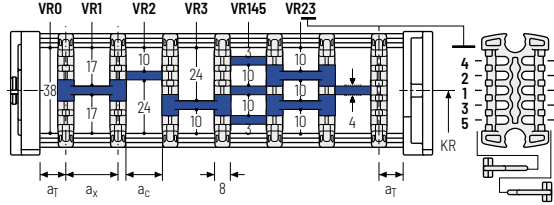

Aluminum partitions in 1 mm increments with $a_x > 42$ mm are also available.

a_x (center distance of dividers) [mm]											
a_c (nominal width of inner chamber) [mm]											
16	18	23	28	32	33	38	43	48	58	64	68
8	10	15	20	24	25	30	35	40	50	56	60
78	80	88	96	112	128	144	160	176	192	208	
70	72	80	88	104	120	136	152	168	184	200	

When using **plastic partitions with $a_x > 112$ mm**, we recommend an additional center support with a **twin divider** ($S_T = 4$ mm). Twin dividers are also suitable for retrofitting in the partition system.

Order example



TS3	.	A	.	3	.	K1	.	34	-	VR1
						⋮		⋮		⋮
						K4	.	38	-	VR3
Divider system		Version		n_T		Chamber		a_x		Height separation

Please state the designation of the divider system (**TS0, TS1,...**), the version, and the number of dividers per cross section [n_T]. In addition, please also enter the chambers [K] from left to right, as well as the assembly distances [a_T/a_x].

If using divider systems with height separation (**TS1 – TS3**), please also state the positions (e.g. VD23) viewed from the left driver belt. You are welcome to add a sketch to your order.



TOTALTRAX® complete systems

Benefit from the advantages of the TOTALTRAX® complete system. A complete delivery from one source – with a warranty certificate on request! Learn more at tsubaki-kabelschlepp.com/totaltrax

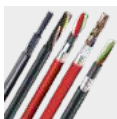

TRAXLINE® cables for cable carriers

Hi-flex electric cables which were especially developed, optimized and tested for use in cable carriers can be found at tsubaki-kabelschlepp.com/traxline

PROTUM®
series

K
series

UNIFLEX
Advanced
series

M
series

XL
series

QUANTUM®
series

TKR
series

TKA
series

UAT
series



Aluminum stay LG - Hole stay, split version

- » Optimum cable routing in the neutral bending line.
Split version for easy cable routing. Stays also available unsplit.
- » Available customized in **1 mm width sections**.
- » **Outside/inside:** Screw-fixing easy to release.



Stay arrangement on every 2nd chain link, **standard** (HS: half-stayed)



Stay arrangement on each chain link (VS: fully-stayed)



1 mm B_i 75 - 600 mm
in 1 mm width sections

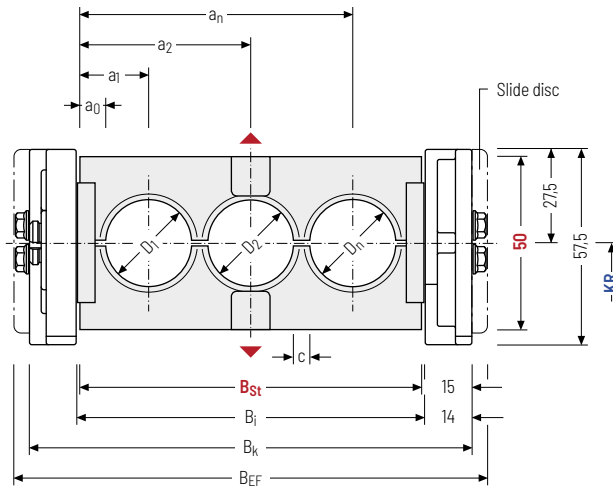

The maximum cable diameter strongly depends on the bending radius and the desired cable type. Please contact us.

Calculating the cable carrier length

Cable carrier length L_k

$$L_k \approx \frac{L_S}{2} + L_B$$

Cable carrier length L_k rounded to pitch t

Calculating the stay width

Stay width B_{St}

$$B_{St} = \sum D + \sum c + 2 a_0$$

The outer width of the cable carrier corresponds to dimension B_{EF} for stay variant LG.

D _{max} [mm]	D _{min} [mm]	h _G [mm]	B _i [mm]	B _{St} [mm]*	B _k [mm]	B _{EF} [mm]	c _{min} [mm]	a ₀ min [mm]	KR [mm]	q _k 50 %** [kg/m]	
36	9	57.5	75 - 600	73 - 598	B _{St} + 30	B _{St} + 38	4	9	75 175	115 220 145 300	2.20 - 5.15

* in 1 mm width sections ** Hole ratio of the hole stay approx. 50 %

Order example



KC0650

Type

176

B_i [mm]

LG

Stay variant

115

KR [mm]

1430

L_k [mm]

HS

Stay arrangement



Subject to change without notice.

PROTUM®
series

K
series

UNIFLEX
Advanced
series

M
series

XL
series

QUANTUM®
series

TKR
series

TKA
series

UAT
series

Aluminum stay RMA – mounting frame stay

- » Aluminum profile bars with plastic mounting frame stays for guiding very large cable diameters.
- » The mounting frame stay can be mounted either inside or outside in the bending radius. Available customized in 1 mm width sections.
- » **Outside/inside:** Screw-fixing easy to release.



Stay arrangement on every 2nd chain link, **standard (HS: half-stayed)**



Stay arrangement on each chain link (**VS: fully-stayed**)



1mm B_i 200 – 400 mm in 1 mm width sections

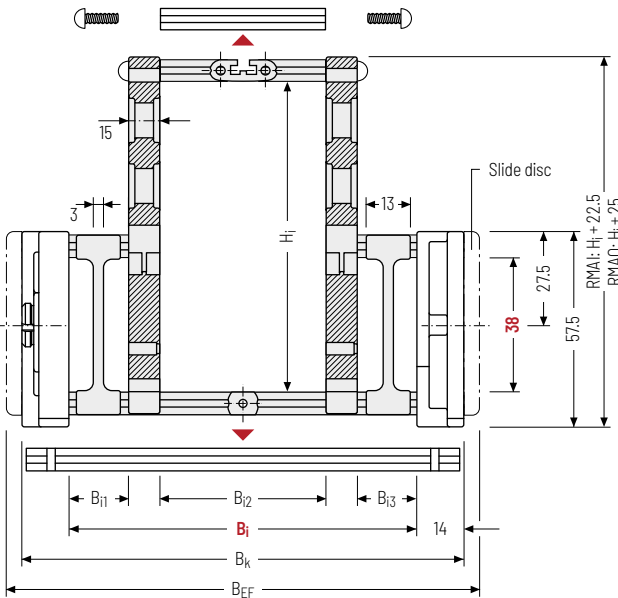

i The maximum cable diameter strongly depends on the bending radius and the desired cable type. Please contact us.

Calculating the cable carrier length

Cable carrier length L_k

$$L_k \approx \frac{L_S}{2} + L_B$$

Cable carrier length L_k rounded to pitch t

i Intrinsic cable carrier weight

Determining the intrinsic cable carrier weight strongly depends on the selected stay arrangement. Please contact us.

h_i [mm]	H_i [mm]	h_G [mm]	B_i [mm]	$B_{i1 \text{ min}}$ [mm]	$B_{i3 \text{ min}}$ [mm]	B_k [mm]	B_{EF} [mm]	KR [mm]
38	130 160	57.5	200 – 400	18	18	$B_i + 28$	$B_i + 36$	75 115 145 175 220 300

Order example



KC0650

Type

276

B_i [mm]

RMA0

Stay variant

145

KR [mm]

1430

L_k [mm]

HS

Stay arrangement

Assembly variants

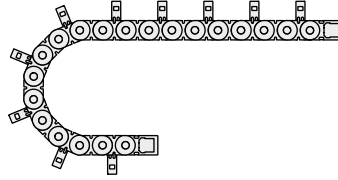
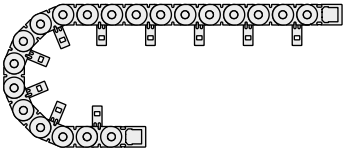

RMAI – assembly to the inside:

Gliding application is not possible when using assembly version RMAI.

Observe minimum KR:

$H_i = 130 \text{ mm}; KR_{\min} = 175 \text{ mm}$

$H_i = 160 \text{ mm}; KR_{\min} = 220 \text{ mm}$

$H_i = 200 \text{ mm}; KR_{\min} = 300 \text{ mm}$

RMAO – assembly to the outside:

The cable carrier has to rest on the side bands and not on the stays.

Guiding in a **channel is required** for support.

Please contact our technical support at technik@kabelschlepp.de to find the corresponding guide channel.

Please note the operating and installation height.



Subject to change without notice.

PROTUM® series
K series
UNIFLEX Advanced series
M series
XL series
QUANTUM® series
TKR series
TKA series
UAT series

Plastic stay RE – screw-in frame stay

- » Plastic profile bars for light and medium loads.
Assembly without screws.
- » Available customized in **8 mm grid**.
- » **Outside/inside:** to open by rotating 90°.



Stay arrangement on every
2nd chain link, **standard**
(**HS: half-stayed**)



Stay arrangement on each
chain link (**VS: fully-stayed**)



8 mm B_i 68 – 260 mm
in **8 mm width sections**

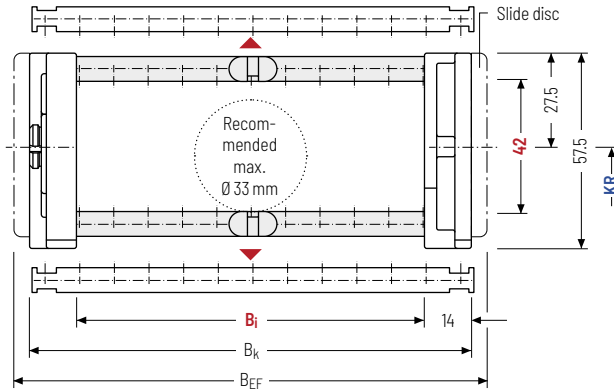

The maximum cable diameter strongly depends on the bending radius and the desired cable type. Please contact us.

Calculating the cable carrier length

Cable carrier length L_k

$$L_k \approx \frac{L_S}{2} + L_B$$

Cable carrier length L_k
rounded to pitch t

h_i [mm]	h_g [mm]	B_i [mm]								B_k [mm]	B_{EF} [mm]	KR [mm]		q_k [kg/m]	
42	57.5	68	76	84	92	100	108	116	124	132	$B_i + 28$	$B_i + 36$	75	115	1.75
		140	148	156	164	172	180	188	196	204			145	175	-
		212	220	228	236	244	252	260	220	300			2.71		

Order example



KE0650
Type

140
 B_i [mm]

RE
Stay variant

115
 KR [mm]

2600
 L_k [mm]

HS
Stay arrangement

Divider systems

The divider system is mounted on each crossbar as a standard – on every 2nd chain link for stay mounting (HS – half-stayed).

As a standard, dividers or the complete divider system (dividers with height separations) are movable in the cross section (**version A**).

For applications with lateral accelerations and applications with the cable carrier rotated by 90°, the dividers can easily be fixed by turning the frame stay by 180°. The arresting cams click into place in the locking grids in the crossbar (**version B**). The groove in the frame stay faces outwards.

Divider system TSO without height separation

Vers.	a _T min [mm]	a _X min [mm]	a _C min [mm]	a _X grid [mm]	n _T min
A	6.5	13	8.8	-	2
B	13	16	11.8	8	2

The dividers can be moved in the cross section.

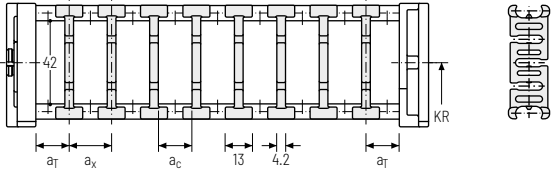

Divider system TS1 with continuous height separation

Vers.	a _T min [mm]	a _X min [mm]	a _C min [mm]	a _X grid [mm]	n _T min
A	6.5	13	8.8	-	2

The dividers can be moved in the cross section.

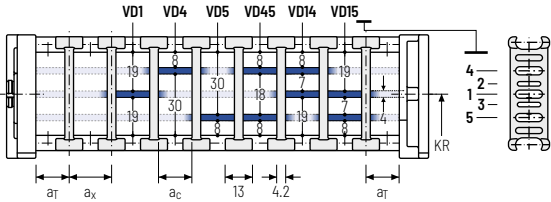

PROTUM® series
K series
UNIFLEX Advanced series
M series
XL series
QUANTUM® series
TKR series
TKA series
UAT series

Additional product information online



Installation instructions, etc.: Additional info via your smartphone or check online at tsubaki-kabelschlepp.com/downloads



Configure your cable carrier here: online-engineer.de

Divider system TS3 with height separation consisting of plastic partitions

Vers.	a_T min [mm]	a_x min [mm]	a_c min [mm]	n_T min
A	4	16 / 42*	8	2

* For aluminum partitions

The dividers are fixed with the partitions. The entire divider system can be moved in the cross section.

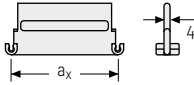
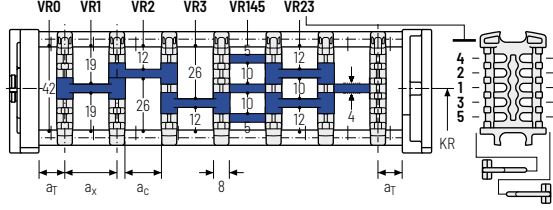

Aluminum partitions in 1 mm increments with $a_x > 42$ mm are also available.

a_x (center distance of dividers) [mm]											
a_c (nominal width of inner chamber) [mm]											
16	18	23	28	32	33	38	43	48	58	64	68
8	10	15	20	24	25	30	35	40	50	56	60
78	80	88	96	112	128	144	160	176	192	208	
70	72	80	88	104	120	136	152	168	184	200	

When using **plastic partitions with $a_x > 112$ mm**, we recommend an additional center support with a **twin divider** ($S_T = 4$ mm). Twin dividers are also suitable for retrofitting in the partition system.

Order example

TS3	.	A	.	3	.	K1	.	34	-	VR1
⋮				⋮		⋮		⋮		⋮
K4	.	38	-	VR3						
Divider system		Version		n_T		Chamber		a_x		Height separation

Please state the designation of the divider system (**TS0, TS1,...**), the version, and the number of dividers per cross section [n_T]. In addition, please also enter the chambers [K] from left to right, as well as the assembly distances [a_T/a_x].

If using divider systems with height separation (**TS1 – TS3**), please also state the positions (e.g. VD23) viewed from the left driver belt. You are welcome to add a sketch to your order.



TOTALTRAX® complete systems

Benefit from the advantages of the TOTALTRAX® complete system. A complete delivery from one source – with a warranty certificate on request! Learn more at tsubaki-kabelschlepp.com/totaltrax

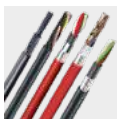

TRAXLINE® cables for cable carriers

Hi-flex electric cables which were especially developed, optimized and tested for use in cable carriers can be found at tsubaki-kabelschlepp.com/traxline

Universal end connectors UMB – plastic (standard)

The universal mounting brackets (UMB) are made from plastic and can be mounted **from the top, from the bottom or face on**.

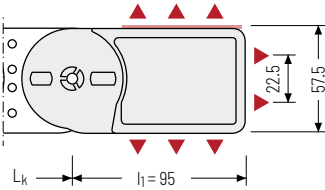

▲ Assembly options

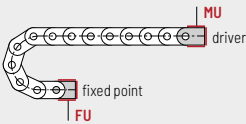
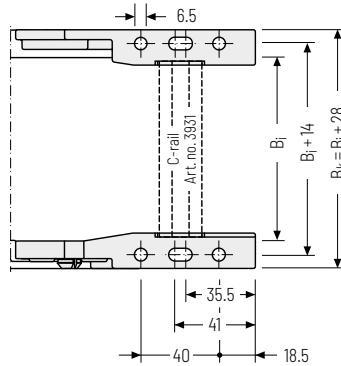

Connection point
F - fixed point
M - driver

Connection type
U - Universal mounting bracket

Order example

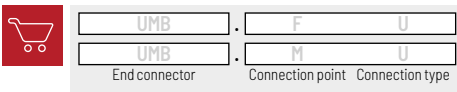

 We recommend the use of strain reliefs at the driver and fixed point. See from p. 904.

Additional product information online



Installation instructions, etc.:
 Additional info via your smartphone or check online at tsubaki-kabelschlepp.com/downloads



Configure your cable carrier here:
online-engineer.de

PROTUM® series
K series
UNIFLEX Advanced series
M series
XL series
QUANTUM® series
TKR series
TKA series
UAT series

K0900



Pitch
90 mm



Inner heights
50 – 58 mm



Inner widths
81 – 561 mm



Bending radii
130 – 385 mm

Stay variants



Aluminum stay RS page 320

Frame stay, narrow "The standard"

- » Aluminum profile bars for light to medium loads. Assembly without screws.
- » **Outside/inside:** to open by rotating 90°.



Aluminum stay RV page 324

Frame stay, reinforced

- » Aluminum profile bars plastic adapter for medium to high loads and large cable carrier widths. Assembly without screws.
- » **Outside/inside:** to open by rotating 90°.



Aluminum stay LG page 328

Hole stay, split version

- » Optimum cable routing in the neutral bending line. Split version for easy cable routing. Stays also available unsplit.
- » **Outside/inside:** Screw-fixing easy to release.



Aluminum stay RMA page 330

Mounting frame stay

- » Aluminum profile bars with plastic mounting frame stays for guiding very large cable diameters.
- » **Outside/inside:** Screw-fixing easy to release.



Plastic stay RE page 332

Frame screw-in stay

- » Plastic profile bars for light to medium loads. Assembly without screws.
- » **Outside/inside:** to open by rotating 90°.

Additional stay variants on request

Aluminum stay RM

Aluminum profile bars for high loads.

Aluminum stay RMR

Gentle cable guiding with rollers.

Unsupported arrangement

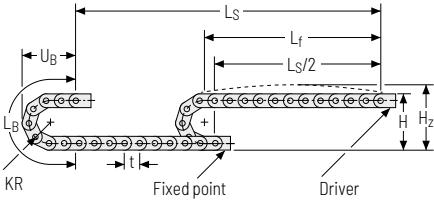

KR [mm]	H [mm]	H ₂ [mm]	L _B [mm]	U _B [mm]
130	336	386	589	258
150	376	426	652	278
190	456	506	777	318
245	566	616	950	373
300	676	726	1123	428
385	846	896	1390	513

Load diagram for unsupported length depending on the additional load.

Sagging of the cable carrier is technically permitted for extended travel lengths, depending on the specific application.

Intrinsic cable carrier weight $q_k = 4.05 \text{ kg/m}$. For other inner widths, the maximum additional load changes.

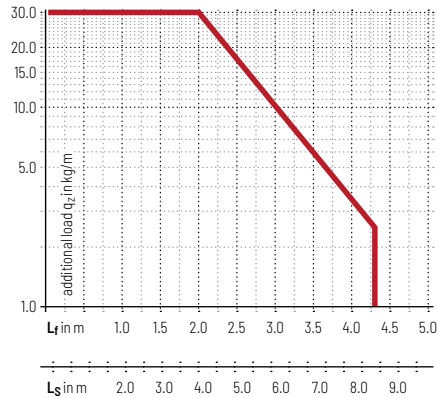

Speed
up to 6 m/s

Acceleration
up to 30 m/s^2

Travel length
up to 8.4 m

Additional load
up to 30 kg/m

Gliding arrangement

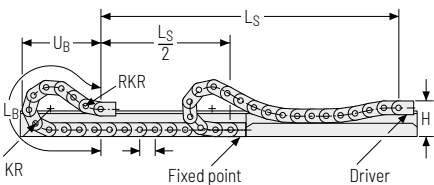

Speed
up to 2 m/s

Acceleration
up to 3 m/s^2

Travel length
up to 260 m

Additional load
up to 30 kg/m

The gliding cable carrier must be guided in a channel. See p. 844.

If the cable carrier is positioned so it is rotated by 90° (gliding on the outside of the side band), slide discs snapped onto the side optimize the friction and wear situation.

Subject to change without notice.

PROTUM® series
K series
UNIFLEX Advanced series
M series
XL series
QUANTUM® series
TKR series
TKA series
UAT series

Aluminum stay RS - frame stay narrow

- » Extremely quick to open and close
- » Aluminum profile bars for light to medium loads.
Assembly without screws.
- » Available customized in **1 mm width sections**.
- » **Outside/inside:** to open by rotating 90°.



Stay arrangement on every
2nd chain link, **standard**
(**HS: half-stayed**)



Stay arrangement on each
chain link (**VS: fully-stayed**)



1 mm B_i 100 - 400 mm
in **1 mm width sections**

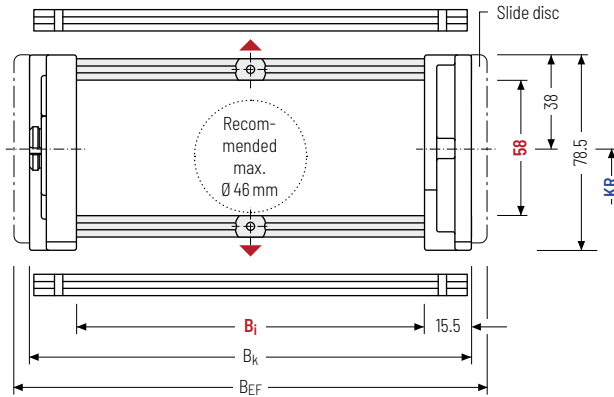

The maximum cable diameter strongly depends on the bending radius and the desired cable type. Please contact us.

Calculating the cable carrier length

Cable carrier length L_k

$$L_k \approx \frac{L_G}{2} + L_B$$

Cable carrier length L_k
rounded to pitch t

h _i [mm]	h _G [mm]	B _i [mm]*	B _k [mm]	B _{EF} [mm]	KR [mm]						q _k [kg/m]
58	78.5	100 - 400	B _i + 31	B _i + 45	130	150	190	245	300	385	2.8 - 5.8

* in 1 mm width sections

Order example



KC0900

Type

300

B_i [mm]

RS

Stay variant

150

KR [mm]

1890

L_k [mm]

HS

Stay arrangement

Divider system TS3 with height separation consisting of plastic partitions

As a standard, the divider **version A** is used for vertical partitioning within the cable carrier. The complete divider system can be moved within the cross section.

PROTUM® series

K series

Divider version A

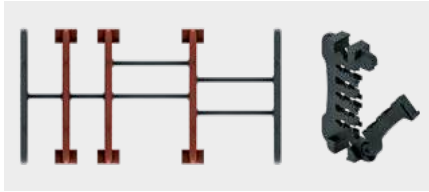

End divider

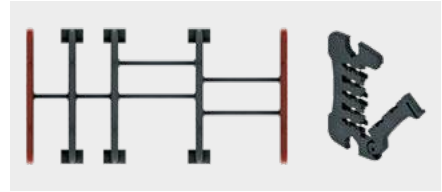

UNIFLEX Advanced series

M series

Vers.	a_T min [mm]	a_x min [mm]	a_c min [mm]	n_T min
A	6 / 2*	14	10	2

* For End divider

The dividers are fixed by the partitions, the complete divider system is movable in the cross section.

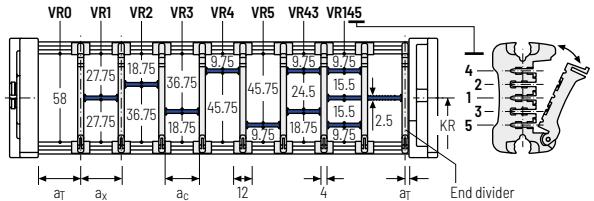

XL series

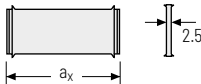

a_x (center distance of dividers) [mm]																
a_c (nominal width of inner chamber) [mm]																
14	16	19	23	24	28	29	32	33	34	38	39	43	44	48	49	54
10	12	15	19	20	24	25	28	29	30	34	35	39	40	44	45	50
58	59	64	68	69	74	78	79	80	84	88	89	94	96	99	112	
54	55	60	64	65	70	74	75	76	80	84	85	90	92	95	108	

When using partitions with $a_x > 49$ mm we recommended an additional preferential central support.

QUANTUM® series

Order example



TS3	A	3	K1	34	VR1
			:	:	:
			K4	38	VR3
Divider system	Version	n_T	Chamber	a_x	Height separation

TKR series

TKA series

Please state the designation of the divider system (**TS0, TS1,...**), version and number of dividers per cross section [n_T]. In addition, please also enter the chambers [K] from left to right, as well as the assembly distances [a_T/a_x] (as seen from the driver).

If using divider systems with height separation (**TS1, TS3**) please also state the positions [e.g. VD23] viewed from the left driver belt. You are welcome to add a sketch to your order.

UAT series

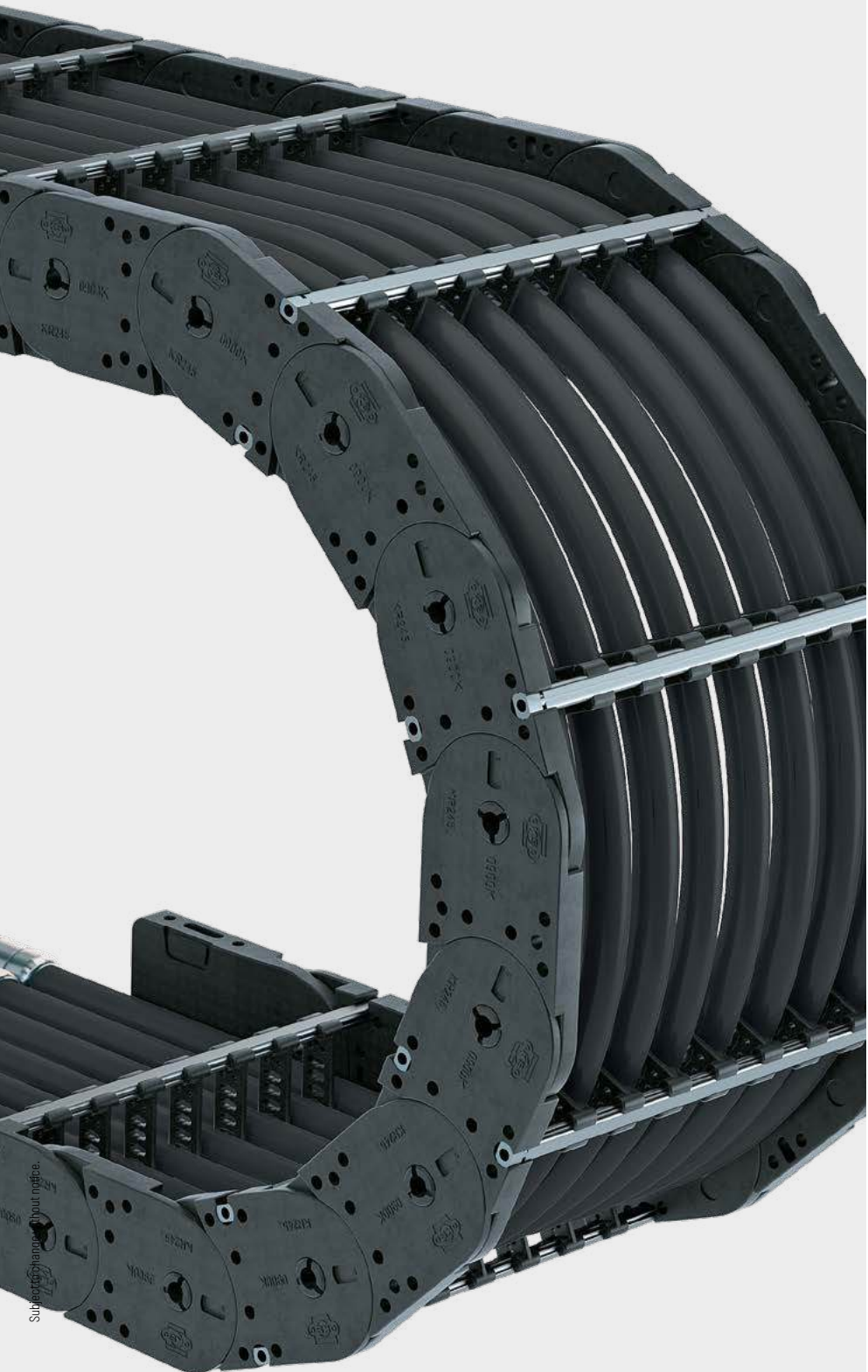

PROTUM®
series

K
series

UNIFLEX
Advanced
series

M
series

XL
series

QUANTUM®
series

TKR
series

TKA
series

UAT
series

Aluminum stay RV - frame stay reinforced

- » Aluminum profile bars plastic adapter for medium to high loads and large cable carrier widths. Assembly without screws.
- » Available customized in **1 mm grid**.
- » **Outside/inside:** to open by rotating 90°.



Stay arrangement on every 2nd chain link, **standard (HS: half-stayed)**



Stay arrangement on each chain link (**VS: fully-stayed**)



1 mm B_i 100 – 500 mm in **1 mm width sections**

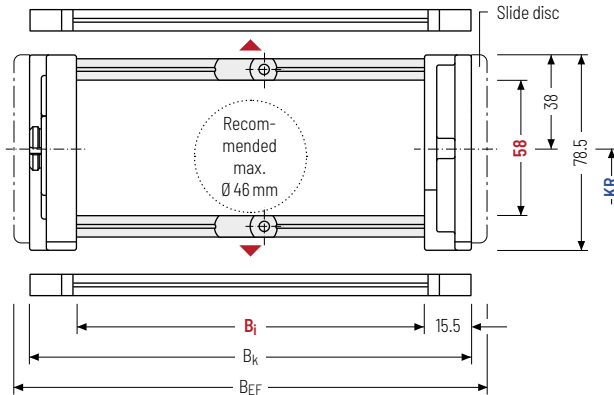

The maximum cable diameter strongly depends on the bending radius and the desired cable type. Please contact us.

Calculating the cable carrier length

Cable carrier length L_k

$$L_k \approx \frac{L_S}{2} + L_B$$

Cable carrier length L_k rounded to pitch t

h_i [mm]	h_G [mm]	B_i [mm]*	B_k [mm]	B_{EF} [mm]	KR [mm]			q_k [kg/m]			
58	78.5	100 – 500	$B_i + 31$	$B_i + 45$	130	150	190	245	300	385	3.2 – 7.0

* in 1 mm width sections

Order example



KC0900

Type

400

B_i [mm]

RV

Stay variant

150

KR [mm]

1890

L_k [mm]

HS

Stay arrangement

Divider systems

The divider system is mounted on each crossbar as a standard – on every 2nd chain link for stay mounting (HS – half-stayed).

As a standard, dividers or the complete divider system (dividers with height separations) are movable in the cross section (**version A**).

Divider system TSO without height separation

Vers.	a _T min [mm]	a _x min [mm]	a _c min [mm]	η _T min
A	7	14	10	-

The dividers can be moved in the cross section.

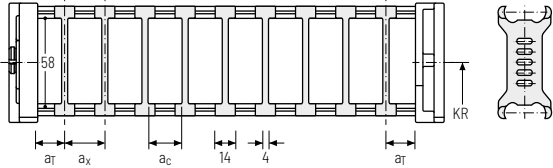

Divider system TS1 with continuous height separation

Vers.	a _T min [mm]	a _T max [mm]	a _x min [mm]	a _c min [mm]	η _T min
A	7	25	14	10	2

The dividers can be moved in the cross section.

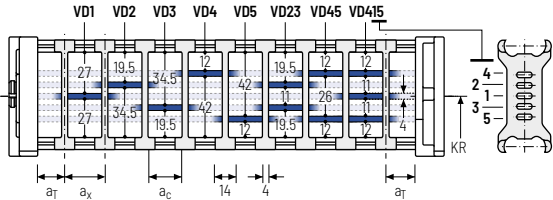

Divider system TS2 with partial height separation

Vers.	a _T min [mm]	a _x min [mm]	a _c min [mm]	η _T min
A	8	21	15	2

With grid distribution (1mm grid). The dividers are attached by the height separation, the grid can be moved in the cross section.

Sliding dividers are optionally available (thickness of divider = 4 mm).

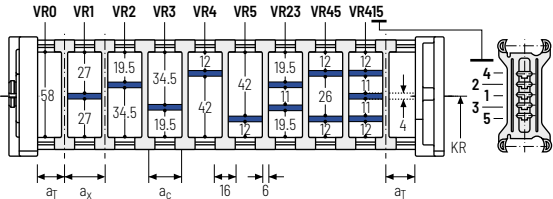

PROTUM® series
K series
UNIFLEX Advanced series
M series
XL series
QUANTUM® series
TKR series
TKA series
UAT series

Additional product information online



Installation instructions, etc.: Additional info via your smartphone or check online at tsubaki-kabelschlepp.com/downloads



Configure your cable carrier here: online-engineer.de

Divider system TS3 with height separation consisting of plastic partitions

Vers.	a_T min [mm]	a_x min [mm]	a_c min [mm]	n_T min
A	4	16 / 42*	8	2

* For aluminum partitions

The dividers are fixed by the partitions, the complete divider system is movable in the cross section.

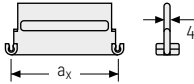
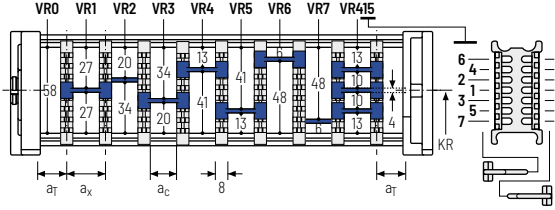

Aluminum partitions in 1 mm increments with $a_x > 42$ mm are also available.

a_x (center distance of dividers) [mm]											
a_c (nominal width of inner chamber) [mm]											
16	18	23	28	32	33	38	43	48	58	64	68
8	10	15	20	24	25	30	35	40	50	56	60
78	80	88	96	112	128	144	160	176	192	208	
70	72	80	88	104	120	136	152	168	184	200	

When using **plastic partitions with $a_x > 112$ mm**, we recommend an additional center support with a **twin divider** ($S_T = 4$ mm). Twin dividers are also suitable for retrofitting in the partition system.

Order example



TS3	A	3	K1	34	VR1
			⋮	⋮	⋮
			K4	38	VR3
Divider system	Version	n_T	Chamber	a_x	Height separation

Please state the designation of the divider system (**TS0, TS1,...**), the version, and the number of dividers per cross section [n_T]. In addition, please also enter the chambers [K] from left to right, as well as the assembly distances [a_T/a_x].

If using divider systems with height separation (**TS1 - TS3**), please also state the positions (e.g. VD23) viewed from the left driver belt. You are welcome to add a sketch to your order.

Additional product information online



Installation instructions, etc.:
Additional info via your smartphone or check online at
[tsubaki-kabelschlepp.com/downloads](https://www.tsubaki-kabelschlepp.com/downloads)



Configure your cable carrier here:
[online-engineer.de](https://www.online-engineer.de)

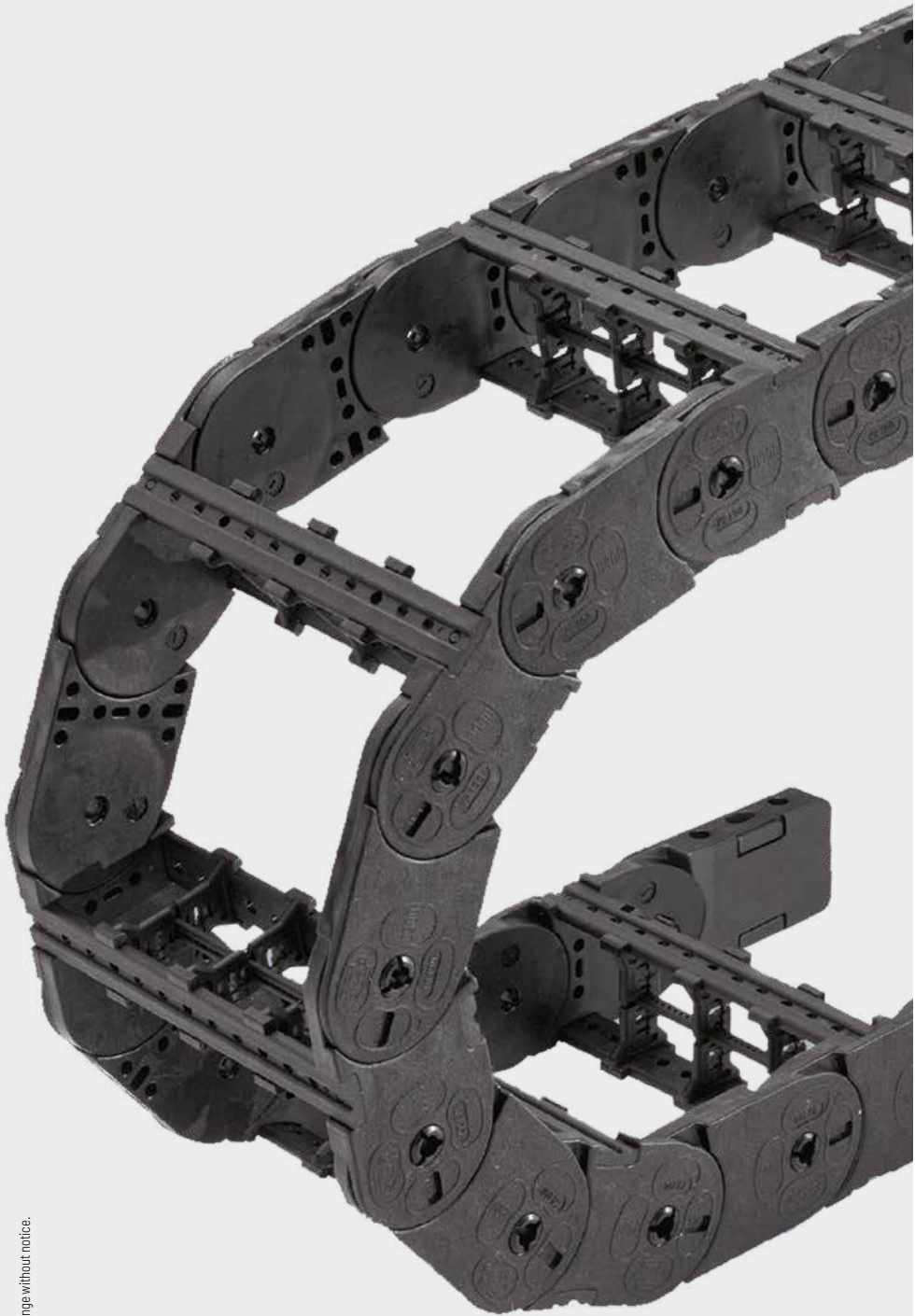

UAT
series

TKA
series

TKR
series

QUANTUM®
series

XL
series

M
series

UNIFLEX
Advanced
series

K
series

PROTUM®
series

Aluminum stay LG - Hole stay, split version

- » Optimum cable routing in the neutral bending line.
Split version for easy cable routing. Stays also available unsplit.
- » Available customized in **1 mm width sections**.
- » **Outside/inside:** Screw-fixing easy to release.



Stay arrangement on every 2nd chain link, **standard (HS: half-stayed)**



Stay arrangement on each chain link (**VS: fully-stayed**)



1 mm B_i 100 – 700 mm
in **1 mm width sections**

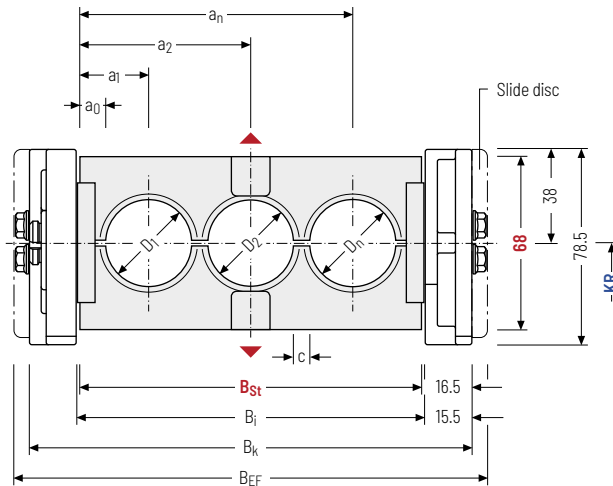

The maximum cable diameter strongly depends on the bending radius and the desired cable type. Please contact us.

Calculating the cable carrier length L_k

Cable carrier length L_k

$$L_k \approx \frac{L_S}{2} + L_B$$

Cable carrier length L_k rounded to pitch t

Calculating the stay width

Stay width B_{St}

$$B_{St} = \sum D + \sum c + 2 a_0$$

The outer width of the cable carrier corresponds to dimension B_{EF} for stay variant LG.

D_{max} [mm]	D_{min} [mm]	h_G [mm]	B_i [mm]	B_{St} [mm]*	B_k [mm]	B_{EF} [mm]	c_{min} [mm]	a_0 min [mm]	KR [mm]	q_k 50%** [kg/m]		
50	10	78.5	100 – 700	98 – 698	$B_{St} + 33$	$B_{St} + 45$	4	11	130 245	150 300	190 385	4.79 – 9.83

* in 1 mm width sections ** Hole ratio of the hole stay approx. 50 %

Order example



KC0900

Type

400

B_i [mm]

LG

Stay variant

150

KR [mm]

1890

L_k [mm]

HS

Stay arrangement



PROTUM®
series

K
series

UNIFLEX
Advanced
series

M
series

XL
series

QUANTUM®
series

TKR
series

TKA
series

UAT
series

Aluminum stay RMA – mounting frame stay

- ▶ Aluminum profile bars with plastic mounting frame stays for guiding very large cable diameters.
- ▶ The mounting frame stay can be mounted either inside or outside in the bending radius. Available customized in **1 mm width sections**.
- ▶ **Outside/inside:** Screw-fixing easy to release.

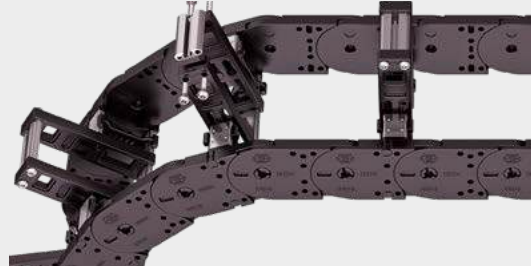

Stay arrangement on every 2nd chain link, **standard (HS: half-stayed)**



Stay arrangement on each chain link (**VS: fully-stayed**)



1 mm B_i 200 – 500 mm in **1 mm width sections**

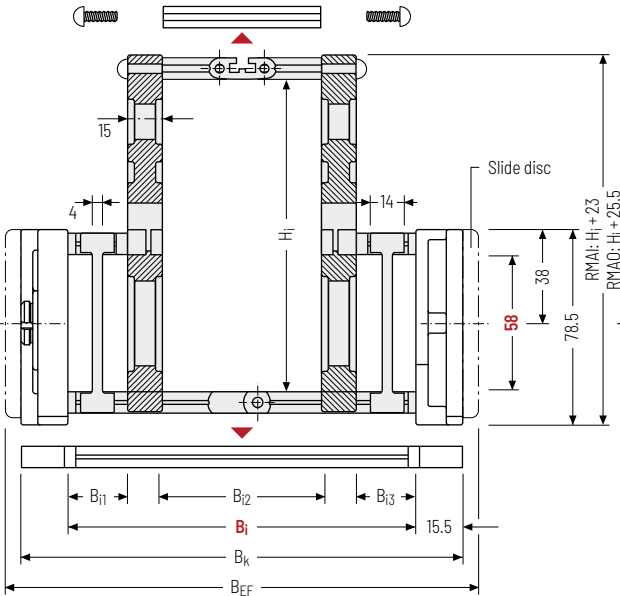

i The maximum cable diameter strongly depends on the bending radius and the desired cable type. Please contact us.

Calculating the cable carrier length

Cable carrier length L_k

$$L_k \approx \frac{L_S}{2} + L_B$$

Cable carrier length L_k rounded to pitch t

i Intrinsic cable carrier weight

Determining the intrinsic cable carrier weight strongly depends on the selected stay arrangement. Please contact us.

h_i [mm]	H_i [mm]	h_G [mm]	B_i [mm]	$B_{i1 \text{ min}}$ [mm]	$B_{i3 \text{ min}}$ [mm]	B_k [mm]	B_{EF} [mm]	KR [mm]
58	130 200	160	78.5	200 - 500	40	40	$B_i + 31$ $B_i + 45$	130 150 245
								150 300 385

Order example



KC0900

Type

400

B_i [mm]

RMAO

Stay variant

150

KR [mm]

1890

L_k [mm]

HS

Stay arrangement

Assembly variants

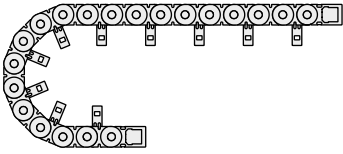

RMAI – assembly to the inside:

Gliding application is not possible when using assembly version RMAI.

Observe minimum KR:

H_i = 130 mm: KR_{min} = 150 mm

H_i = 160 mm: KR_{min} = 190 mm

H_i = 200 mm: KR_{min} = 245 mm

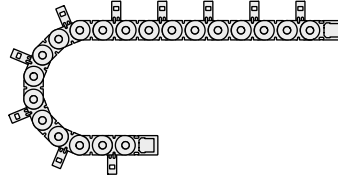

RMAO – assembly to the outside:

The cable carrier has to rest on the side bands and not on the stays.

Guiding in a **channel is required** for support.

Please contact our technical support at technik@kabelschlepp.de to find the corresponding guiding channel.

Please note the operating and installation height.



Subject to change without notice.

PROTUM® series
K series
UNIFLEX Advanced series
M series
XL series
QUANTUM® series
TKR series
TKA series
UAT series

Plastic stay RE - frame screw-in stay

- » Plastic profile bars for light to medium loads.
Assembly without screws.
- » Available customized in **16 mm grid**.
- » **Outside/inside:** to open by rotating 90°.



Stay arrangement on every
2nd chain link, **standard**
(**HS: half-stayed**)



Stay arrangement on each
chain link (**VS: fully-stayed**)



16 mm B_i 81 – 561 mm
in **16 mm width sections**

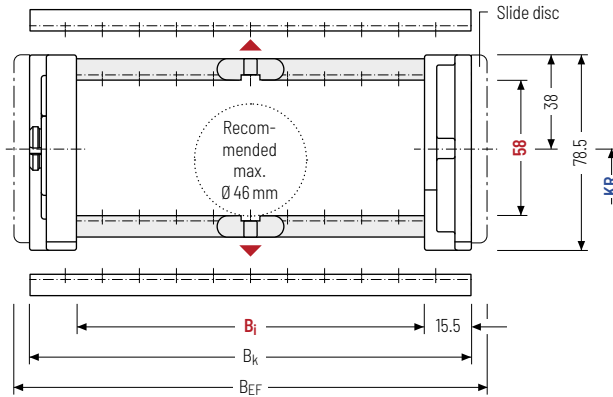

The maximum cable diameter strongly depends on the bending radius and the desired cable type. Please contact us.

Calculating the cable carrier length

Cable carrier length L_k

$$L_k \approx \frac{L_S}{2} + L_B$$

Cable carrier length L_k
rounded to pitch t

h_1 [mm]	h_G [mm]	B_i [mm]										B_k [mm]	B_{EF} [mm]	KR [mm]		q_k [kg/m]
58	78.5	81	97	113	129	145	161	177	193	209	225	$B_i + 31$	$B_i + 45$	130	150	2.95
		241	257	273	289	305	321	337	353	369	385			190	245	-
		401	417	433	449	465	481	497	513	545	561			300	385	5.95

Order example



KE0900

Type

209

B_i [mm]

RE

Stay variant

150

KR [mm]

1890

L_k [mm]

HS

Stay arrangement

Divider systems

The divider system is mounted on each crossbar as a standard – on every 2nd chain link for stay mounting (HS – half-stayed).

For applications with lateral accelerations and applications with the cable carrier rotated by 90°, the dividers can easily be fixed by turning the frame stay by 180°. The arresting cams click into place in the locking grids in the crossbar (**version B**).

As a standard, dividers or the complete divider system (dividers with height separations) are movable in the cross section (**version A**).

The groove in the frame stay faces outwards.

Divider system TSO without height separation

Vers.	a _T min [mm]	a _x min [mm]	a _c min [mm]	a _x Raster [mm]	Π _T min
A	7.5	14.5	8.5	-	-
B	8.5	16	10	16	-

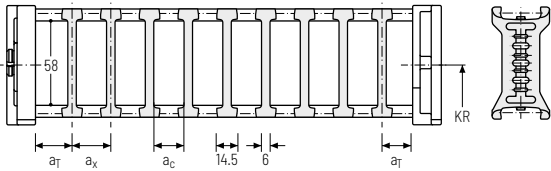

The dividers can be moved within the cross section (version A) or fixed (version B).

Divider system TS1 with continuous height separation

Vers.	a _T min [mm]	a _x min [mm]	a _c min [mm]	a _x Raster [mm]	Π _T min
A	7.5	14.5	8.5	-	2
B	8.5	16	10	16	2

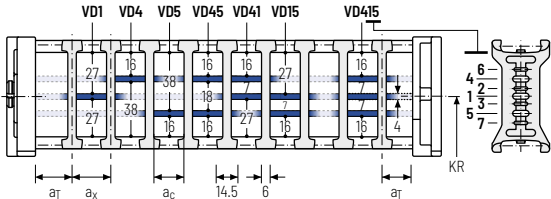

The dividers can be moved within the cross section (version A) or fixed (version B).

Divider system TS2 with partial height separation

Vers.	a _T min [mm]	a _x min [mm]	a _c min [mm]	a _x Raster [mm]	Π _T min
A	7.5	14.5*/21	8.5*/15	-	2
B	8.5	16*/32	10*/26	16	2

* for VR0

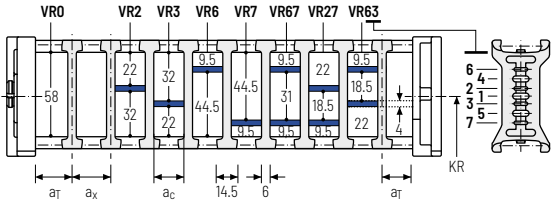

With grid distribution (16 mm grid). The dividers are attached by the height separation, the grid can be moved in the cross section (version A) or fixed (version B).

PROTUM® series

K series

UNIFLEX Advanced series

M series

XL series

QUANTUM® series

TKR series

TKA series

UAT series

Additional product information online



Installation instructions, etc.: Additional info via your smartphone or check online at tsubaki-kabelschlepp.com/downloads



Configure your cable carrier here: online-engineer.de

Divider system TS3 with height separation consisting of plastic partitions

Vers.	a_T min [mm]	a_x min [mm]	a_c min [mm]	n_T min
A	4	16 / 42*	8	2

* For aluminum partitions

The dividers are fixed by the partitions, the complete divider system is movable in the cross section.

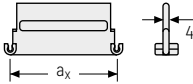
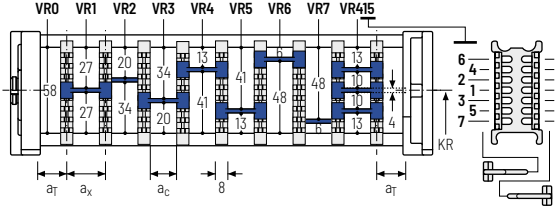

Aluminum partitions in 1 mm increments with $a_x > 42$ mm are also available.

a_x (center distance of dividers) [mm]											
a_c (nominal width of inner chamber) [mm]											
16	18	23	28	32	33	38	43	48	58	64	68
8	10	15	20	24	25	30	35	40	50	56	60
78	80	88	96	112	128	144	160	176	192	208	
70	72	80	88	104	120	136	152	168	184	200	

When using **plastic partitions with $a_x > 112$ mm**, we recommend an additional center support with a **twin divider** ($S_T = 4$ mm). Twin dividers are also suitable for retrofitting in the partition system.

Order example



TS3	.	A	.	3	.	K1	.	34	-	VR1
						⋮		⋮		⋮
						K4	.	38	-	VR3
Divider system		Version		n_T		Chamber		a_x		Height separation

Please state the designation of the divider system (**TS0, TS1,...**), the version, and the number of dividers per cross section [n_T]. In addition, please also enter the chambers [K] from left to right, as well as the assembly distances [a_T/a_x].

If using divider systems with height separation (**TS1 – TS3**), please also state the positions (e.g. VD23) viewed from the left driver belt. You are welcome to add a sketch to your order.



TOTALTRAX® complete systems

Benefit from the advantages of the TOTALTRAX® complete system. A complete delivery from one source – with a warranty certificate on request! Learn more at tsubaki-kabelschlepp.com/totaltrax



TRAXLINE® cables for cable carriers

Hi-flex electric cables which were especially developed, optimized and tested for use in cable carriers can be found at tsubaki-kabelschlepp.com/traxline

Universal end connectors UMB – plastic (standard)

The universal mounting brackets (UMB) are made from plastic and can be mounted **from the top, from the bottom, face on or from the side.**

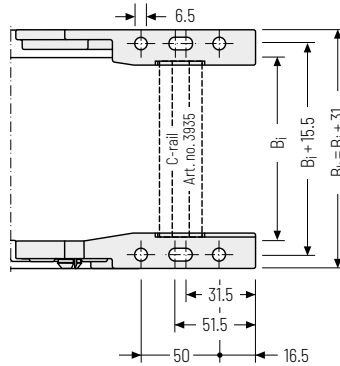
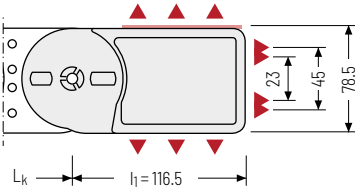

▲ Assembly options

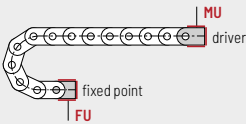

Connection point
F - fixed point
M - driver

Connection type
U - Universal mounting bracket

Order example

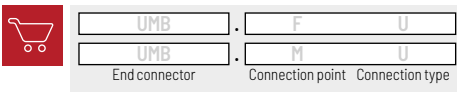

 We recommend the use of strain reliefs at the driver and fixed point. See from p. 904.

Additional product information online



Installation instructions, etc.:
 Additional info via your smartphone or check online at tsubaki-kabelschlepp.com/downloads



Configure your cable carrier here:
online-engineer.de

PROTUM® series
K series
UNIFLEX Advanced series
M series
XL series
QUANTUM® series
TKR series
TKA series
UAT series

UNIFLEX *Advanced* series

Light and quiet all-rounder



Trademarks are legally protected for the TSUBAKI KABELSCHLEPP GmbH
as a national or international registration in the following countries:
tsubaki-kabelschlepp.com/trademarks

Subject to change without notice.

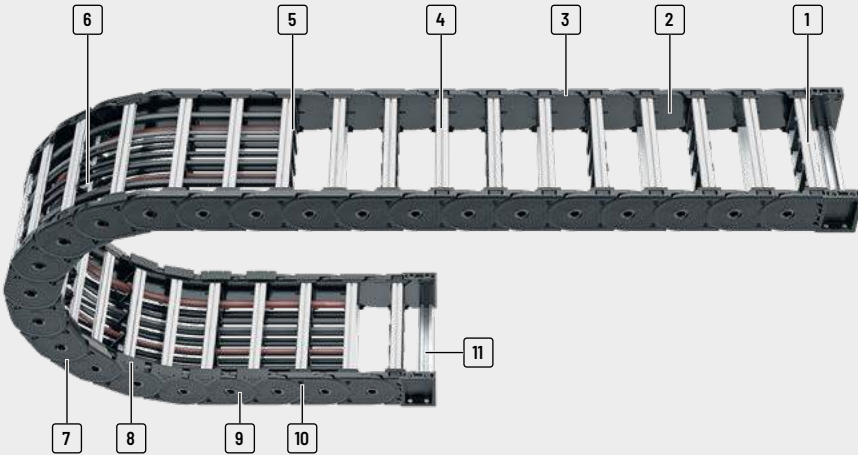

- 1 Aluminum stays available in **1 mm width sections**
- 2 Favourable ratio of inner to outer width
- 3 Chain link plates made of at least 35 % pure regrgranulate
- 4 Quick and easy opening to the inside or outside for cable laying
- 5 Fixable dividers
- 6 Many separation options for the cables
- 7 Robust double-stroke system for long unsupported lengths
- 8 Replaceable glide shoes
- 9 Very quiet through integrated noise damping
- 10 Lateral wear surfaces
- 11 C-rail for strain relief elements

Features

- » Four designs: closed, and openable to the inner or outer side or to both sides
- » Good ratio of inner to outer width
- » Easy assembly and fast cable laying
- » UMB connectors made of sturdy plastic (strengths comparable to aluminium)
- » Low-wear, cable-friendly design with smooth surface
- » Polygon-optimized bending radii for smooth and low-wear chain running

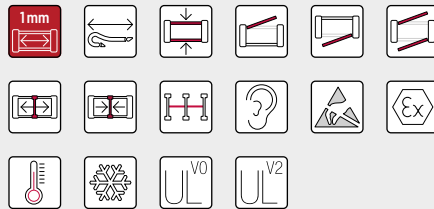

Replaceable glide shoes - optionally with automatic wear monitoring



UMB connectors made of sturdy plastic (strengths comparable to aluminium)

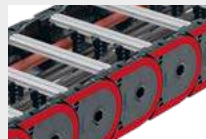

Lateral wear surfaces - for long service life for applications where the carrier is rotated through 90°



Rear grips at stopper for better force transmission and higher strengths

PROTUM®
series

K
series

UNIFLEX
Advanced
series

M
series

XL
series

QUANTUM®
series

TKR
series

TKA
series

UAT
series

Type	Opening variant	Stay variant	h_i [mm]	h_G [mm]	B_i [mm]	B_k [mm]	B_i - grid [mm]	t [mm]	KR [mm]	Additional load \leq [kg/m]	Cable- d_{max} [mm]
UA1995											
		RSH 020	80	110	66 - 600	96 - 630	1	99.5	150 - 500	50	64
		RSH 030	80	110	66 - 600	96 - 630	1	99.5	150 - 500	50	64
		RSH 040	80	110	66 - 600	96 - 630	1	99.5	150 - 500	50	64
		RSH 070	80	110	66 - 600	96 - 630	1	99.5	150 - 500	50	64

PROTUM®
seriesK
seriesUNIFLEX
Advanced
seriesM
seriesXL
seriesQUANTUM®
seriesTKR
seriesTKA
seriesUAT
series

Unsupported arrangement			Gliding arrangement			Inner Distribution				Movement			Page
Travel length ≤ [m]	$v_{max} \leq [m/s]$	$a_{max} \leq [m/s^2]$	Travel length ≤ [m]	$v_{max} \leq [m/s]$	$a_{max} \leq [m/s^2]$	TS0	TS1	TS2	TS3	vertical hanging or standing	lying on the side	rotating arrangement	
										vertical hanging or standing	lying on the side	rotating arrangement	
9	10	25	200	8	20	•	-	-	•	•	•	•	342
9	10	25	200	8	20	•	•	-	•	•	•	•	343
9	10	25	200	8	20	•	•	-	•	•	•	•	344
9	10	25	200	8	200	•	•	-	•	•	•	•	345

PROTUM® series

K series

UNIFLEX Advanced series

M series

XL series

QUANTUM® series

TKR series

TKA series

UAT series

UA1995



Pitch
99.5 mm



Inner height
80 mm



Inner widths
66 – 600 mm



Bending radii
150 – 500 mm

Stay variants

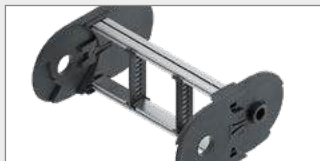

Design RSH 020 page **342**

Closed frame

- » Aluminum profile bars for light to medium loads.
Assembly without screws.
- » **Outside/inside:** not openable.

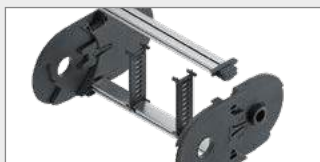

Design RSH 030 page **343**

Frame with outside detachable stays

- » Aluminum profile bars for light to medium loads.
Assembly without screws.
- » **Outside:** release by rotating 90°.



Design RSH 040 page **344**

Frame with inside detachable stays

- » Aluminum profile bars for light to medium loads.
Assembly without screws.
- » **Inside:** release by rotating 90°.



Design RSH 070 page **345**

Frame with outside and inside detachable stays

- » Aluminum profile bars for light to medium loads.
Assembly without screws.
- » **Outside/inside:** release by rotating 90°.

Unsupported arrangement

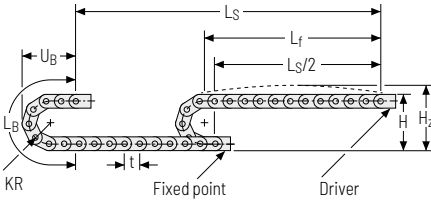

KR [mm]	H [mm]	H ₂ [mm]	L _B [mm]	U _B [mm]
150	410	440	680	250
210	530	560	860	310
250	610	640	990	350
300	710	740	1150	400
350	810	840	1300	450
400	910	940	1460	500
500	1110	1140	1770	600

Load diagram for unsupported length depending on the additional load.

Sagging of the cable carrier is technically permitted for extended travel lengths, depending on the specific application.

Intrinsic cable carrier weight $q_k = 3.85 \text{ kg/m}$ with B_i 196 mm. For other inner widths, the maximum additional load changes.

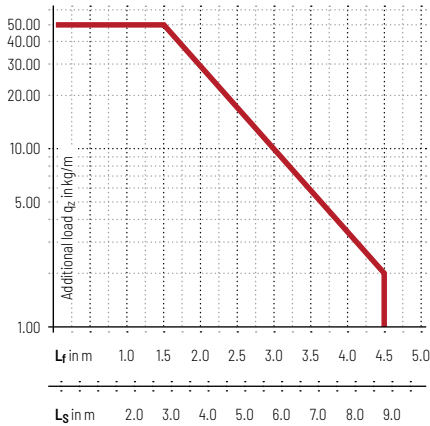

- Speed**
up to 10 m/s
- Acceleration**
up to 25 m/s²
- Travel length**
up to 9 m
- Additional load**
up to 50 kg/m

Gliding arrangement | GO module with chain links optimized for gliding*

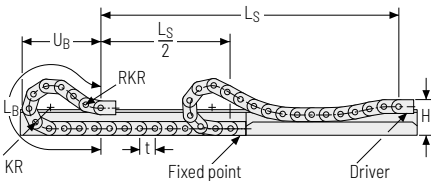

KR [mm]	H [mm]	GO-Modul RKR [mm]	L _B [mm]	U _B [mm]
150	330	400	1805	890
210	330	400	2180	1010
250	330	400	2390	1070
300	330	400	2690	1160
350	330	400	3090	1310
400	330	400	3490	1450
500	330	400	4280	1740

- Speed**
up to 8 m/s
- Acceleration**
up to 20 m/s²
- Travel length**
up to 200 m
- Additional load**
up to 50 kg/m

The gliding cable carrier must be guided in a channel. See p. 844.

The GO module mounted on the driver is a defined sequence of 5 adapted KR/RKR link plates.

Glide shoes must be used for gliding applications.

* only design 070

PROTUM® series
K series
UNIFLEX Advanced series
M series
XL series
QUANTUM® series
TKR series
TKA series
UAT series

Stay variant RSH 020 – closed frame

- » Aluminum profile bars for light to medium loads. Assembly without screws.
- » Available customized in **1 mm grid**.
- » **Outside/inside:** not openable.



Stay arrangement on each chain link (**VS: fully-stayed**)



1mm B_i66 – 600 mm
in 1 mm width sections

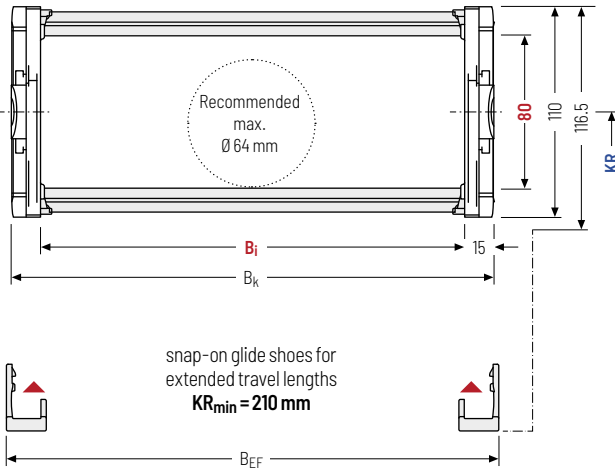

The maximum cable diameter strongly depends on the bending radius and the desired cable type. Please contact us.

Calculating the cable carrier length

Cable carrier length L_k

$$L_k \approx \frac{L_S}{2} + L_B$$

Cable carrier length L_k
rounded to pitch t

h_i [mm]	h_G [mm]	h_G' [mm]	B_i [mm]*	B_k [mm]	B_{EF} [mm]	KR [mm]						q_k [kg/m]	
80	110	116.5	66 – 600	$B_i + 30$	$B_i + 36$	150	210	250	300	350	400	500	4,168 – 4,173

* in 1 mm width sections

Order example



UA1995
Type

150
 B_i [mm]

RSH 020
Stay variant

210
 KR [mm]

3582
 L_k [mm]

VS
Stay arrangement

Stay variant RSH 030 –
with outside detachable stays

- » Aluminum profile bars for light to medium loads.
Assembly without screws.
- » Available customized in **1 mm grid**.
- » **Outside:** release by rotating 90°.



 Stay arrangement on each chain link (**VS: fully-stayed**)

 **1mm** B_i 66 – 600 mm
in 1 mm width sections

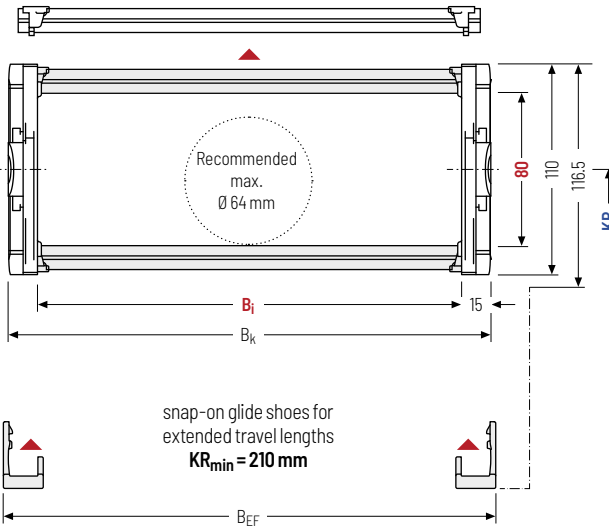

 The maximum cable diameter strongly depends on the bending radius and the desired cable type. Please contact us.

Calculating the cable carrier length

Cable carrier length L_k

$$L_k \approx \frac{L_S}{2} + L_B$$

Cable carrier length L_k rounded to pitch t

h _i [mm]	h _G [mm]	h _G ' [mm]	B _i [mm]*	B _k [mm]	B _{EF} [mm]	KR [mm]					q _k [kg/m]		
80	110	116.5	66 - 600	B _i + 30	B _i + 36	150	210	250	300	350	400	500	4,192 - 4,197

* in 1 mm width sections

Order example

 UA1995 · 150 · RSH 030 · 210 · 3582 · VS

Type · B_i [mm] · Stay variant · KR [mm] · L_k [mm] · Stay arrangement

PROTUM® series
K series
UNIFLEX Advanced series
M series
XL series
QUANTUM® series
TKR series
TKA series
UAT series

Stay variant RSH 040 – with inside detachable stays

- » Aluminum profile bars for light to medium loads. Assembly without screws.
- » Available customized in **1 mm grid**.
- » **Inside:** release by rotating 90°.



Stay arrangement on each chain link (**VS: fully-stayed**)



1 mm B_i: 66 – 600 mm in **1 mm** width sections

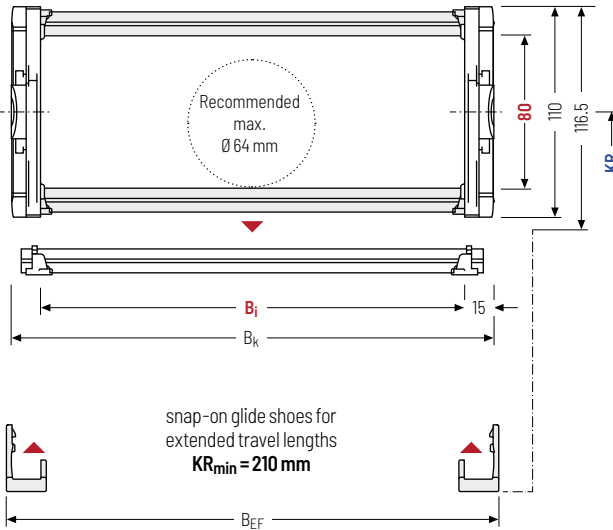

i The maximum cable diameter strongly depends on the bending radius and the desired cable type. Please contact us.

i Design RSH 040 is not suitable for a gliding arrangements without the use of gliding shoes.

Calculating the cable carrier length

Cable carrier length L_k

$$L_k \approx \frac{L_S}{2} + L_B$$

Cable carrier length L_k rounded to pitch t

h _i [mm]	h _G [mm]	h _{G'} [mm]	B _i [mm]*	B _k [mm]	B _{EF} [mm]	KR [mm]					q _k [kg/m]		
80	110	116.5	66 – 600	B _i + 30	B _i + 36	150	210	250	300	350	400	500	4.192 – 4.197

* in 1 mm width sections

Order example

UA1995
150
RSH 040
210
3582
VS

Type B_i [mm] Stay variant KR [mm] L_k [mm] Stay arrangement

Stay variant RSH 070 – with outside and inside detachable stays

- » Aluminum profile bars for light to medium loads. Assembly without screws.
- » Available customized in **1 mm grid**.
- » **Outside/Inside:** release by rotating 90°.



Stay arrangement on each chain link (**VS: fully-stayed**)

1mm B_i 66 – 600 mm in 1 mm width sections

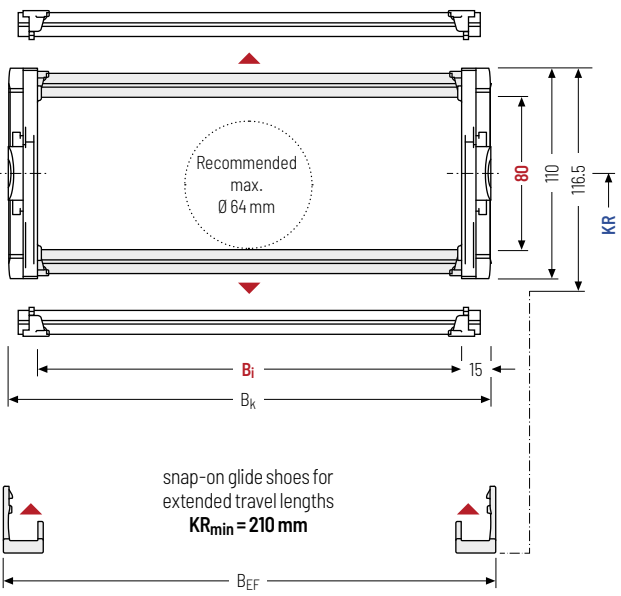

The maximum cable diameter strongly depends on the bending radius and the desired cable type. Please contact us.

Design RSH 070 is not suitable for a gliding arrangements without the use of gliding shoes.

Calculating the cable carrier length

Cable carrier length L_k

$$L_k \approx \frac{L_S}{2} + L_B$$

Cable carrier length L_k rounded to pitch t

h _i [mm]	h _G [mm]	h _G ' [mm]	B _i [mm]*	B _k [mm]	B _{EF} [mm]	KR [mm]					q _k [kg/m]		
80	110	116.5	66 - 600	B _i + 30	B _i + 36	150	210	250	300	350	400	500	4,211 - 4,216

* in 1 mm width sections

Order example

UA1995 ·
 150 B_i [mm] ·
 RSH 070 ·
 210 KR [mm] ·
 3582 L_k [mm] ·
 VS Stay arrangement

PROTUM® series
 K series
 UNIFLEX Advanced series
 M series
 XL series
 QUANTUM® series
 TKR series
 TKA series
 UAT series

Divider systems

The divider system is mounted on every 2nd chain link as a standard.

For applications with lateral acceleration and lying on the side, the dividers can be attached by a fixing profile, available as an accessory (**version B**). The fixing profile must be installed at the factory.

As a standard, dividers or the complete divider system (dividers with height separations) are movable in the cross section (**version A**).

PROTUM® series

K series

UNIFLEX Advanced series

Divider system TSO without height separation

Vers.	a _T min [mm]	a _X min [mm]	a _C min [mm]	a _X grid [mm]	η _T min
A	10	16	12	-	-
B	10	17.5	13.5	2.5	-

Number of dividers for design 020 depending on B;

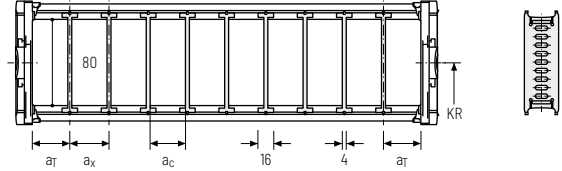

Divider system TS1 with continuous height separation*

Vers.	a _T min [mm]	a _X min [mm]	a _C min [mm]	a _X grid [mm]	η _T min
A	10	16	12	-	2
B	10	17.5	13.5	2.5	2

* not for design 020

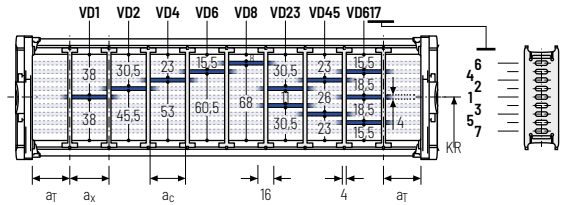

M series

XL series

Order example

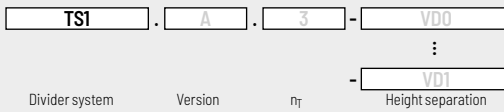

Please state the designation of the divider system (TS0, TS1,...), the version, and the number of dividers per cross section [η_T].

When using divider systems with height separation (TS1), please additionally state the position (e.g. VD1) viewed from the left driver belt. You are welcome to add a sketch to your order.

TKR series

TKA series

UAT series

Divider system TS3 with height separation consisting of plastic partitions

As a standard, the divider **version A** is used for vertical partitioning within the cable carrier. The complete divider system can be moved within the cross section.

Divider version A

End divider



Vers.	a _T min [mm]	a _x min [mm]	a _c min [mm]	n _T min
A	8 / 4*	14	10	2

Number of dividers for design D20 depending on B;
* For End divider

The dividers are fixed by the partitions, the complete divider system is movable in the cross section.

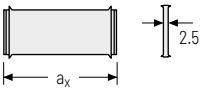
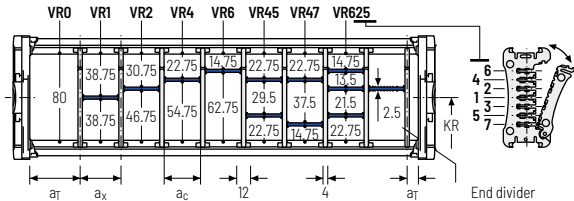

a _x (center distance of dividers) [mm]																
a _c (nominal width of inner chamber) [mm]																
14	16	19	23	24	28	29	32	33	34	38	39	43	44	48	49	54
10	12	15	19	20	24	25	28	29	30	34	35	39	40	44	45	50
58	59	64	68	69	74	78	79	80	84	88	89	94	96	99	112	
54	55	60	64	65	70	74	75	76	80	84	85	90	92	95	108	

An additional central support is required when using plastic partitions with a_x > 49 mm.

Order example

TS3 .
 A .
 3 .
 K1 .
 34 -
 VR1
 : : :
 . K4 . 38 - VR3
 Divider system Version n_T Chamber a_x Height separation

Please state the designation of the divider system (**TS0, TS1,...**), version and number of dividers per cross section [n_T]. In addition, please also enter the chambers [K] from left to right, as well as the assembly distances [a_T/a_x] (as seen from the driver).

If using divider systems with height separation (**TS1, TS3**) please also state the positions [e.g. VD23] viewed from the left driver belt. You are welcome to add a sketch to your order.

- PROTUM® series
- K series
- UNIFLEX Advanced series
- M series
- XL series
- QUANTUM® series
- TKR series
- TKA series
- UAT series

PROTUM®
series

K
series

UNIFLEX
Advanced
series

M
series

XL
series

QUANTUM®
series

TKR
series

TKA
series

UAT
series



Universal end connectors UMB – plastic (standard)

The universal mounting brackets (UMB) are made from plastic and can be mounted **from above, from below or on the face side**.

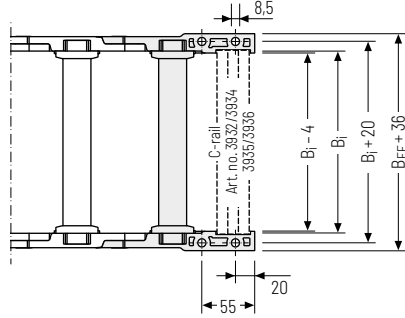
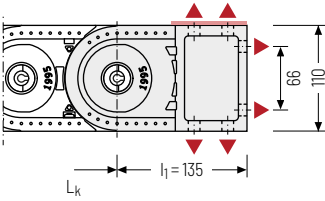

▲ Assembly options

Recommended tightening torque:
27 Nm for screws M8

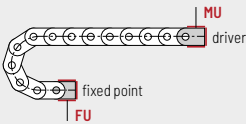

Connection point
F - fixed point
M - driver

Connection type
U - Universal mounting bracket

Order example

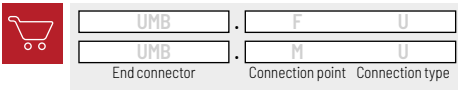

We recommend the use of strain reliefs at the driver and fixed point. See from p. 904.

Additional product information online



Installation instructions, etc.:
Additional info via your smartphone or check online at tsubaki-kabelschlepp.com/downloads



Configure your cable carrier here:
online-engineer.de

PROTUM® series
K series
UNIFLEX Advanced series
M series
XL series
QUANTUM® series
TKR series
TKA series
UAT series

M series

Variable cable carrier
with extensive accessories
and stay variants



Trademarks are legally protected for the TSUBAKI KABELSCHLEPP GmbH as a national or international registration in the following countries: tsubaki-kabelschlepp.com/trademarks

Subject to change without notice

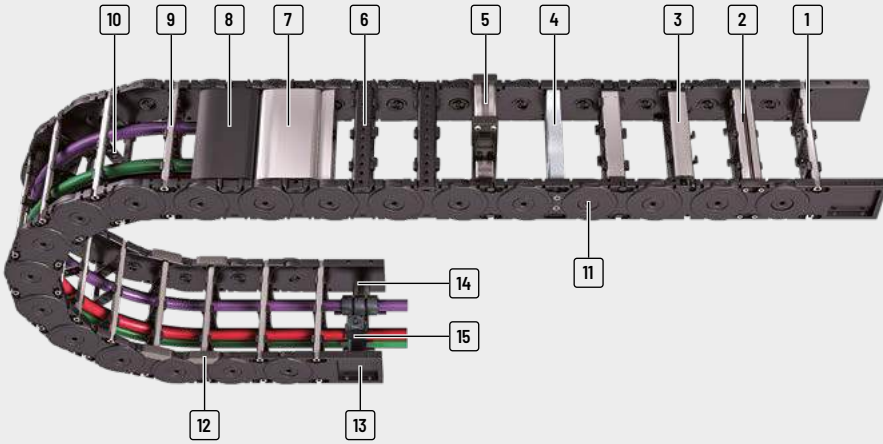

- | | | | |
|--|--|---|--|
| <p>1 Aluminum stays available in 1 mm width sections</p> <p>2 4-fold bolted aluminum stays for extreme loads</p> <p>3 Aluminum stays with ball joint</p> <p>4 Aluminum hole stays</p> | <p>5 Mounting frame stays</p> <p>6 Plastic stays available in 4, 8 or 16 mm width sections</p> <p>7 Aluminum cover available in 1 mm width sections</p> | <p>8 Plastic cover available in 8 or 16 mm width sections</p> <p>9 Can be opened quickly on the inside and the outside for cable laying</p> <p>10 Fixable dividers</p> <p>11 Locking bolts</p> | <p>12 Replaceable glide shoes</p> <p>13 Universal end connectors (UMB)</p> <p>14 C-rail for strain relief elements</p> <p>15 Strain relief combs</p> |
|--|--|---|--|

Features

- » Encapsulated, dirt-resistant stroke system
- » Durable sidebands through robust link plate design
- » Easy assembly of side bands through bars with easy-to-assemble locking bolts
- » Long service life due to minimized hinge wear owing to the "life extending 2 disc principle"
- » Large selection of vertical and horizontal stay systems and dividing options for your cables
- » Versions with aluminum stays in 1 mm width sections up to 800 mm inner width
- » Versions with plastic stays available in 4, 8 or 16 mm width sections



Minimized hinge wear owing to the "life extending 2 disc principle"



Sturdy link plate design, encapsulated stroke system



Easy to assemble through locking bolts



Replaceable glide shoes for long service life for gliding applications

PROTUM®
series

K
series

UNIFLEX
Advanced
series

M
series

XL
series

QUANTUM®
series

TKR
series

TKA
series

UAT
series

Type	Opening variant	Stay variant	h_i	h_G	B_i	B_k	B_i - grid	t	KR	Additional load \leq [kg/m]	Cable- d_{max} [mm]
			[mm]	[mm]	[mm]	[mm]	[mm]	[mm]	[mm]		
PROTUM® series											
M0320											
		RS 01	19	27.5	25 - 280	36 - 291	1	32	37 - 200	2.5	15
		RS 02	19	27.5	25 - 280	36 - 291	1	32	37 - 200	2.5	15
		RE	19	27.5	25 - 189	36 - 200	4	32	37 - 200	2.5	15
M0475											
		RD 01	28	39	24 - 280	41 - 297	8	47.5	55 - 300	3.0	22
		RD 02	28	39	24 - 280	41 - 297	8	47.5	55 - 300	3.0	22
M0650											
		RS	38	57	75 - 400	109 - 434	1	65	75 - 350	25	30
		LG	36	57	75 - 600	109 - 634	1	65	75 - 350	25	29
		RMA	38 (200)	57 (224)	200 - 400	234 - 434	1	65	75 - 350	25	30 (160)
		RE	42	57	50 - 266	84 - 300	8	65	75 - 350	25	33
		RD	42	57	50 - 266	84 - 300	8	65	75 - 350	25	33
M0950											
		RS	58	80	75 - 400	114 - 439	1	95	140 - 380	35	46
		RV	58	80	75 - 500	114 - 539	1	95	140 - 380	35	46
		RM	54	80	75 - 600	114 - 639	1	95	140 - 380	35	43
		LG	50	80	75 - 600	114 - 639	1	95	140 - 380	35	38
		RMA	58 (200)	80 (224)	200 - 500	239 - 539	1	95	140 - 380	35	46 (160)
		RMR	51	80	75 - 600	114 - 639	1	95	140 - 380	35	46
		RE	58	80	45 - 557	84 - 596	16	95	140 - 380	35	46
		RD	58	80	45 - 557	84 - 596	16	95	140 - 380	35	46
	UAT series										

Unsupported arrangement			Gliding arrangement			Inner Distribution				Movement			Page
Travel length ≤ [m]	$v_{max} \leq [m/s]$	$a_{max} \leq [m/s^2]$	Travel length ≤ [m]	$v_{max} \leq [m/s]$	$a_{max} \leq [m/s^2]$	TS0	TS1	TS2	TS3	vertical hanging or standing	lying on the side	rotating arrangement	
2.8	10	50	80	2.5	25	•	•	-	-	•	•	•	358
2.8	10	50	80	2.5	25	•	•	-	-	•	•	•	358
2.8	10	50	80	2.5	25	•	•	-	-	•	•	•	360
2.7	10	50	-	-	-	•	•	•	-	•	•	•	366
2.7	10	50	-	-	-	•	•	•	-	•	•	•	368
4.8	10	40	220	8	20	•	•	•	•	•	•	•	374
4.8	10	40	220	8	20	-	-	-	-	•	•	•	378
4.8	10	40	220	8	20	•	-	-	-	•	•	-	380
4.8	10	40	220	8	20	•	•	-	•	•	•	•	382
4.8	10	40	220	8	20	•	•	-	•	•	•	•	383
7.4	10	30	260	8	20	•	•	•	•	•	•	•	392
7.4	10	30	260	8	20	•	•	•	•	•	-	•	396
7.4	10	30	260	8	20	•	•	•	-	•	•	•	400
7.4	10	30	260	8	20	-	-	-	-	•	•	•	402
7.4	10	30	260	8	20	•	-	-	-	•	•	-	404
7.4	10	30	260	8	20	•	-	-	-	•	•	•	406
7.4	10	30	260	8	20	•	•	•	•	•	•	•	408
7.4	10	30	260	8	20	•	•	•	•	•	•	•	409

Subject to change without notice.

PROTUM® series

K series

UNIFLEX Advanced series

M series

XL series

QUANTUM® series











TKR series

TKA series

UAT series

Type	Opening variant	Stay variant	h_i [mm]	h_G [mm]	B_i [mm]	B_k [mm]	B_i - grid [mm]	t [mm]	KR [mm]	Additional load ≤ [kg/m]	Cable- d_{max} [mm]
M1250											
K series		RS	72	96	75 - 400	120 - 445	1	125	180 - 500	65	61
		RV	72	96	100 - 600	145 - 645	1	125	180 - 500	65	61
		RM	69	96	100 - 800	145 - 845	1	125	180 - 500	65	59
UNIFLEX Advanced series		LG	76	96	100 - 800	145 - 845	1	125	180 - 500	65	59
		RMA	72 (200)	96 (226)	200 - 800	245 - 845	1	125	180 - 500	65	61 (160)
M series		RMR	66	96	100 - 800	145 - 845	1	125	180 - 500	65	54
		RE	72	96	71 - 551	116 - 596	16	125	180 - 500	65	61
		RD	72	96	71 - 551	116 - 596	16	125	180 - 500	65	61
M1300											
XL series		RMF	87	120	100 - 800	150 - 850	1	130	150 - 500	70	75
		RMS	87	120	100 - 800	150 - 850	1	130	150 - 500	70	75
		LG	98	120	100 - 800	150 - 850	1	130	150 - 500	70	74

* Further information on request.

Unsupported arrangement			Gliding arrangement			Inner Distribution				Movement			Page
Travel length ≤ [m]	$v_{max} \leq [m/s]$	$a_{max} \leq [m/s^2]$	Travel length ≤ [m]	$v_{max} \leq [m/s]$	$a_{max} \leq [m/s^2]$	TS0	TS1	TS2	TS3	vertical hanging or standing	lying on the side	rotating arrangement	
										vertical hanging or standing	lying on the side	rotating arrangement	
9.7	10	25	320	8	20	•	•	-	•	•	•	•	418
9.7	10	25	320	8	20	•	•	•	•	•	-	•	422
9.7	10	25	320	8	20	•	•	•	-	•	•	•	426
9.7	10	25	320	8	20	-	-	-	-	•	•	•	428
9.7	10	25	320	8	20	•	-	-	-	•	•	-	430
9.7	10	25	320	8	20	•	-	-	-	•	•	•	432
9.7	10	25	320	8	20	•	•	•	•	•	•	•	434
9.7	10	25	320	8	20	•	•	•	•	•	•	•	435
10.8	10	25	350	8	20	•	•	-	•	-	-	-	442
10.8	10	25	350	8	20	•	•	-	•	•	•	•	444
10.8	10	25	350	8	20	-	-	-	-	•	•	•	446

PROTUM® series

K series

UNIFLEX Advanced series

M series

XL series

QUANTUM® series

TKR series

TKA series

UAT series

M0320



Pitch
32 mm



Inner height
19 mm



Inner widths
25 – 280 mm



Bending radii
37 – 200 mm

Stay variants



Aluminum stay 01..... page 358

Frame stay detachable inside

- » Aluminum profile bars for light to medium loads.
Assembly without screws.
- » **Inside:** release by turning by 90°.



Aluminum stay 02..... page 358

Frame stay detachable outside "the standard"

- » Aluminum profile bars for light to medium loads.
Assembly without screws.
- » **Outside:** release by turning by 90°.



Plastic stay RE..... page 360

Frame screw-in stay

- » Plastic profile bars for light to medium loads.
Assembly without screws.
- » **Inside/outside:** release by turning by 90°.

More product information online



Assembly instructions etc.:
Additional info via your
smartphone or check online at
[tsubaki-kabelschlepp.com/
downloads](http://tsubaki-kabelschlepp.com/downloads)



Configure your custom
cable carrier here:
online-engineer.de

Unsupported arrangement

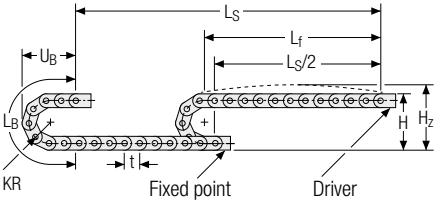



KR [mm]	H [mm]	H _z [mm]	L _B [mm]	U _B [mm]
37	101.5	121.5	181	83
47	121.5	141.5	212	93
77	181.5	201.5	306	123
100	227.5	247.5	379	146
200	427.5	427.5	693	246

Load diagram for unsupported length depending on the additional load.

Sagging of the cable carrier is technically permitted for extended travel lengths, depending on the specific application.

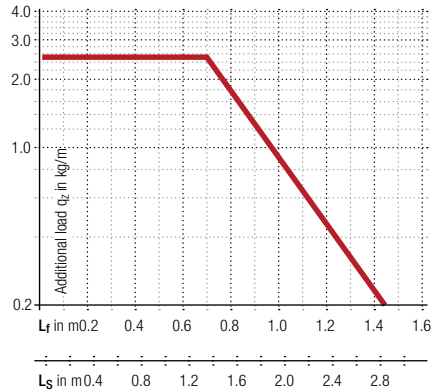



Intrinsic cable carrier weight $q_k = 0.54 \text{ kg/m}$. For other inner widths, the maximum additional load changes.

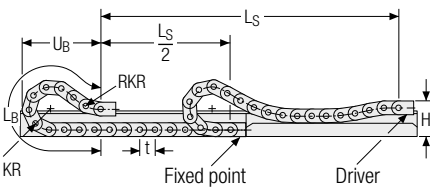

-  **Speed**
up to 10 m/s
-  **Acceleration**
up to 50 m/s²
-  **Travel length**
up to 2.8 m
-  **Additional load**
up to 2.5 kg/m

Gliding arrangement



-  **Speed**
up to 2.5 m/s
 -  **Acceleration**
up to 25 m/s²
 -  **Travel length**
up to 80 m
 -  **Additional load**
up to 2.5 kg/m
-  The gliding cable carrier must be guided in a channel. See p. 844.

 Our technical support can provide help for gliding arrangements:
technik@kabelschlepp.de

PROTUM® series
K series
UNIFLEX Advanced series
M series
XL series
QUANTUM® series
TKR series
TKA series
UAT series

Aluminum stay 01/02 – frame stay detachable outside

- Extremely quick to open and close
- Aluminum profile bars for light to medium loads.
Assembly without screws.
- Available customized in **1 mm grid**.
- **Outside/inside:** release by turning by 90°.

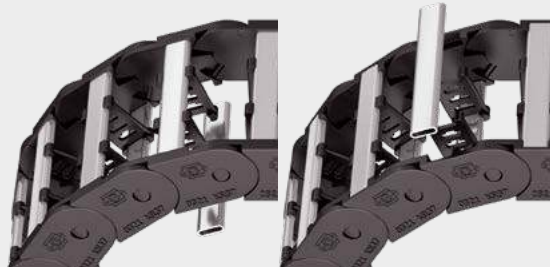

Stay arrangement on each chain link (**VS: fully-stayed**)



1 mm B_i 25 – 280 mm
in 1 mm width sections

Aluminum stay 01 frame stay detachable inside

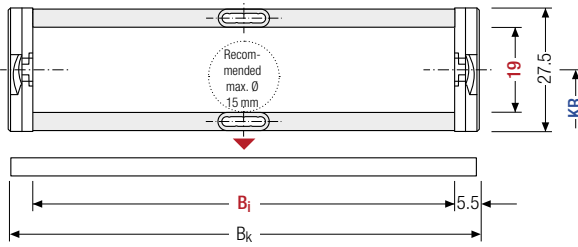

Aluminum stay 02 frame stay detachable outside

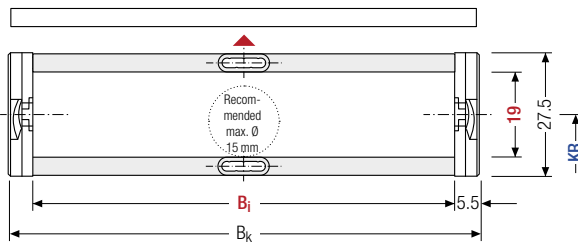

The maximum cable diameter strongly depends on the bending radius and the desired cable type. Please contact us.

Calculating the cable carrier length

Cable carrier length L_k

$$L_k \approx \frac{L_S}{2} + L_B$$

Cable carrier length L_k
rounded to pitch t

h _i [mm]	h _g [mm]	B _i [mm]*	B _k [mm]	KR [mm]			q _k [kg/m]		
19	27.5	25 – 280	B _i + 11	37	47	77	100	200	0.47 – 1.70

* in 1 mm width sections

Order example



MC0320

Type

200

B_i [mm]

01

Stay variant

100

KR [mm]

1152

L_k [mm]

VS

Stay arrangement

Divider systems

As a standard, the divider system is mounted on each crossbar – for stay mounting on every 2nd chain link (HS).

As a standard, dividers and the complete divider system (dividers with height separations) can be moved in the cross section (**version A**).

Divider system TS0 without height separation

Vers.	a _T min [mm]	a _x min [mm]	a _c min [mm]	n _T min
A	3	6	4	2

The dividers can be moved in the cross section.

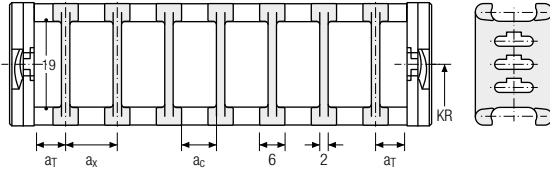

Divider system TS1 with continuous height separation

Vers.	a _T min [mm]	a _T max [mm]	a _x min [mm]	a _c min [mm]	n _T min
A	3	20	6	4	2

The dividers can be moved in the cross section.

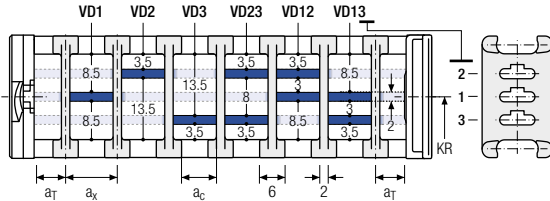

Order example

TS1

A

3

VD1

-

⋮

VD3

-

VD3

Divider system

Version

n_T

Height separation

Please state the designation of the divider system (**TS0, TS1 ...**), version and number of dividers per cross section [n_T].

If using divider systems with height separation (**TS1**) please also state the positions [e.g. VD1] viewed from the left driver belt. You are welcome to add a sketch to your order.

PROTUM® series
K series
UNIFLEX Advanced series
M series
XL series
QUANTUM® series
TKR series
TKA series
UAT series

Plastic stay RE – screw-in frame stay

- Plastic profile bars for light to medium loads.
Assembly without screws.
- Available customized in **4 mm grid**.
- **Outside/inside:** release by turning by 90°.



Stay arrangement on each chain link (**VS: fully-stayed**)



4 mm B_i 25 – 189 mm
in 4 mm width sections

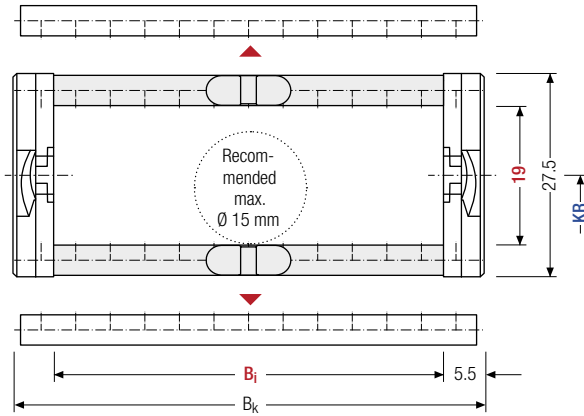

The maximum cable diameter strongly depends on the bending radius and the desired cable type. Please contact us.

Calculating the cable carrier length

Cable carrier length L_k

$$L_k \approx \frac{L_s}{2} + L_B$$

Cable carrier length L_k
rounded to pitch t

h _i [mm]	h _g [mm]	B _i [mm]											B _k [mm]	KR [mm]	q _k [kg/m]	
19	27.5	25	29	33	37	41	45	49	53	57	61	65	B _i + 11	37	47	0.46
		69	73	77	81	85	89	93	97	101	105	109		77	100	
		113	117	121	125	129	133	137	141	145	149	200		1.00		



For B_i > 149 mm we recommend a multi-band chain.

Order example



ME0320

Type

105

B_i [mm]

RE

Stay variant

100

KR [mm]

1152

L_k [mm]

VS

Stay arrangement

Divider systems

As a standard, the divider system is mounted on each crossbar – for stay mounting on every 2nd chain link (HS).
 As a standard, dividers and the complete divider system (dividers with height separations) can be moved in the cross section (**version A**).

The dividers are easily attached to the stay for applications with lateral acceleration and for applications laying on their side by simply turning the frame stay by 180°. The arresting cams click into place in the locking grids in the crossbars (**version B**).
 The groove in the frame stay faces outwards.

Divider system TSO without height separation

Vers.	a _T min [mm]	a _x min [mm]	a _c min [mm]	a _x grid [mm]	n _T min
A	3	6	4	–	–
B	4.5	8	6	4	–

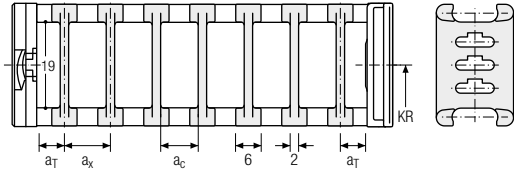

The dividers can be moved in the cross section.

Divider system TS1 with continuous height separation

Vers.	a _T min [mm]	a _T max [mm]	a _x min [mm]	a _c min [mm]	a _x grid [mm]	n _T min
A	3	20	6	4	–	2
B	4.5	20.5	8	6	4	2

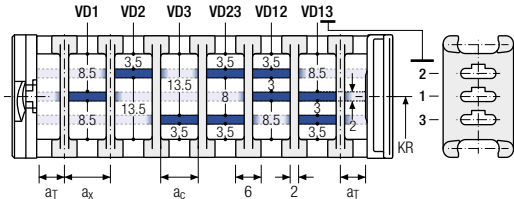

The dividers can be moved in the cross section.

Order example

TS1

A

3

VD1

-

VD1

⋮

VD3

-

VD3

Divider system
Version
n_T
Height separation

Please state the designation of the divider system (**TS0, TS1 ...**), version and number of dividers per cross section [n_T].
 If using divider systems with height separation (**TS1**), please also state the positions [e.g. VD1] viewed from the left driver belt. You are welcome to add a sketch to your order.

PROTUM® series
K series
UNIFLEX Advanced series
M series
XL series
QUANTUM® series
TKR series
TKA series
UAT series

PROTUM®
seriesK
seriesUNIFLEX
Advanced
seriesM
seriesXL
seriesQUANTUM®
seriesTKR
seriesTKA
seriesUAT
series

One part end connectors – plastic/aluminum (with integrated strain relief)

The plastic/aluminum end connectors can be **connected from above or below**. The connection variants on the fixed point and on the driver can be combined and, if required, changed afterwards.

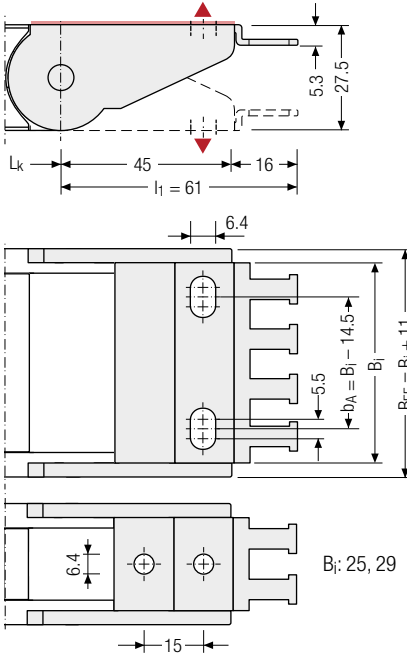

One-part end connectors – plastic/aluminum

The plastic/aluminum end connectors can be **connected from above or below**. The connection variants on the fixed point and on the driver can be combined and, if required, changed afterwards.

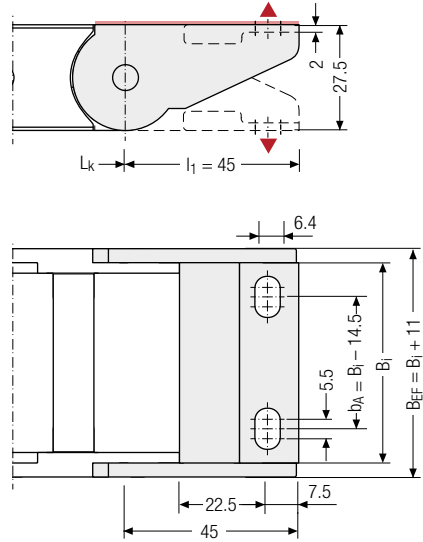

▲ Assembly options

B_i [mm]	n_z	B_i [mm]	n_z	B_i [mm]	n_z	B_i [mm]	n_z
25	2	39	4	89	7	149	11
29	2	49	4	109	8		
37	3	69	5	124	10		

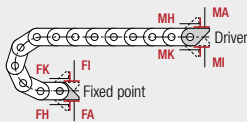

Connection point

F – fixed point
M – driver

Connection type

A – threaded joint outside (standard)
I – threaded joint inside
H – threaded joint, rotated 90° to the outside
K – threaded joint, rotated 90° to the inside

Order example



Plastic/aluminum

F A

Plastic/aluminum

M A

End connector

Connection point

Connection type



We recommend the use of strain reliefs at the driver and fixed point. See from p. 904.



Subject to change without notice.

PROTUM®
series

K
series

UNIFLEX
Advanced
series

M
series

XL
series

QUANTUM®
series

TKR
series

TKA
series

UAT
series

M0475



Pitch
47.5 mm



Inner height
28 mm



Inner widths
24 - 280 mm



Bending radii
55 - 300 mm

Stay variants



Plastic stay RD 01 page 366

Frame stay with hinge in the inner radius

- » Plastic profile bars with hinge for light to medium loads.
Assembly without screws.
- » **Outside:** release by turning by 90°.
- » **Inside:** swivable to both sides.



Plastic stay RD 02 page 368

Frame stay with hinge in the outer radius

- » Plastic profile bars with hinge for light to medium loads.
Assembly without screws.
- » **Outside:** swivable to both sides.
- » **Inside:** release by turning by 90°.



MT series

Also available as covered variants with cover system.
More information can be found
in chapter "MT series" from p. 612.

More product information online



Assembly instructions etc.:
Additional info via your smartphone
or check online at
[tsubaki-kabelschlepp.com/
downloads](http://tsubaki-kabelschlepp.com/downloads)



Configure your custom
cable carrier here:
online-engineer.de

Unsupported arrangement

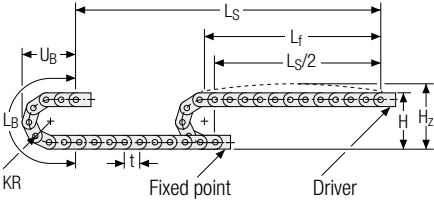

KR [mm]	H [mm]	H _z [mm]	L _B [mm]	U _B [mm]
55	149	174	268	122
75	189	214	331	142
100	239	264	410	167
130	299	324	504	197
160	359	384	598	227
200	439	464	724	267
250	539	564	881	317
300	639	664	1038	367

Load diagram for unsupported length depending on the additional load.

Sagging of the cable carrier is technically permitted for extended travel lengths, depending on the specific application.

Intrinsic cable carrier weight $q_k = 1.7 \text{ kg/m}$. For other inner widths, the maximum additional load changes.

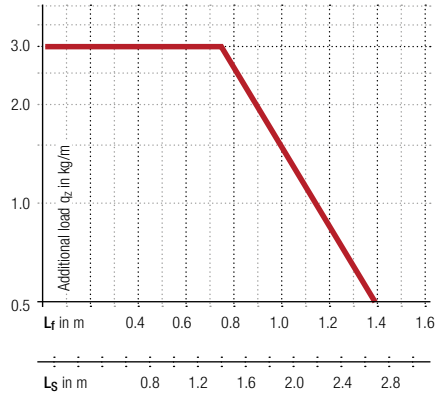

Speed
up to 10 m/s

Acceleration
up to 50 m/s²

Travel length
up to 2.7 m

Additional load
up to 3.0 kg/m

PROTUM® series
K series
UNIFLEX Advanced series
M series
XL series
QUANTUM® series
TKR series
TKA series
UAT series

Plastic stay RD 01 – frame stay with hinge in the inner radius

- Plastic profile bars with hinge for light to medium loads. Assembly without screws.
- Available customized in **8 mm grid**.
- **Outside:** release by turning by 90°.
- **Inside:** swivable to both sides.



Stay arrangement on every chain link (**VS: fully-stayed**)



8 mm B_i 24 – 280 mm
in 8 mm width sections

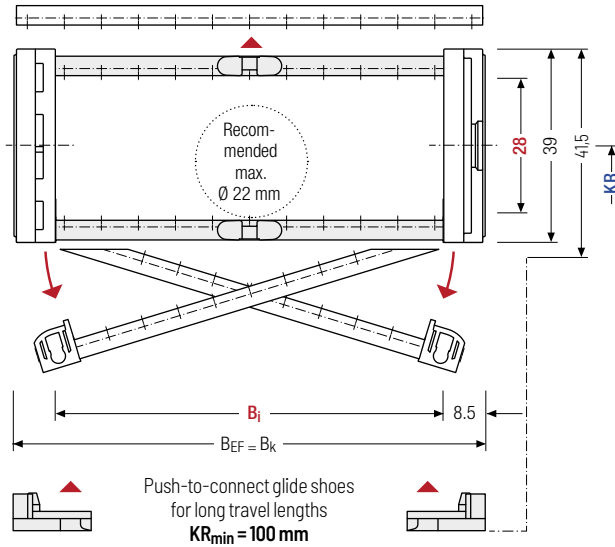

The maximum cable diameter strongly depends on the bending radius and the desired cable type. Please contact us.

Calculating the cable carrier length

Cable carrier length L_k

$$L_k \approx \frac{L_S}{2} + L_B$$

Cable carrier length L_k rounded to pitch t

h _i [mm]	h _g [mm]	B _i [mm]									B _k [mm]	B _{EF} [mm]	KR [mm]		q _k [kg/m]		
28	39	24	32	40	48	56	64	72	80	88	B _i + 17	B _i + 17	55	75	0.79		
		96	104	112	120	128	136	144	152	160			100	130		-	
		168	176	184	192	200	208	216	224	232			160	200			3.03
		240	248	256	264	272	280	250	300								

Order example



MK0475

Type

128

B_i [mm]

RD 01

Stay variant

100

KR [mm]

1425

L_k [mm]

VS

Stay arrangement

Plastic stay RD 02 – frame stay with hinge in the outer radius

- Plastic profile bars with hinge for light to medium loads. Assembly without screws.
- Available customized in **8 mm grid**.
- **Outside:** swivable to both sides.
Inside: release by turning by 90°.



Stay arrangement on every chain link (**VS: fully-stayed**)



8 mm B_i 24 – 280 mm
in **8 mm** width sections

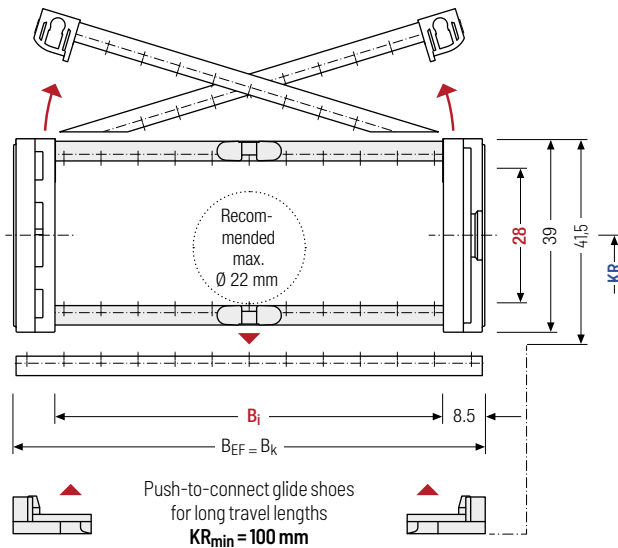

The maximum cable diameter strongly depends on the bending radius and the desired cable type. Please contact us.

Calculating the cable carrier length

Cable carrier length L_k

$$L_k \approx \frac{L_S}{2} + L_B$$

Cable carrier length L_k
rounded to pitch t

h_i [mm]	h_g [mm]	B_i [mm]										B_k [mm]	B_{EF} [mm]	KR [mm]	q_k [kg/m]	
28	39	24	32	40	48	56	64	72	80	88	$B_i + 17$	$B_i + 17$	55	75	0.79	
		96	104	112	120	128	136	144	152	160			100	130		
		168	176	184	192	200	208	216	224	232			160	200		–
		240	248	256	264	272	280	250	300	3.03						

Order example



MK0475

Type

128

B_i [mm]

RD 02

Stay variant

100

KR [mm]

1425

L_k [mm]

VS

Stay arrangement

End connectors – plastic/steel (with strain relief)

Link end connector made of plastic, end connector made of sheet steel with screw-fixed aluminum strain relief. The connection variants on the fixed point and on the driver can be combined and, if required, changed afterwards.

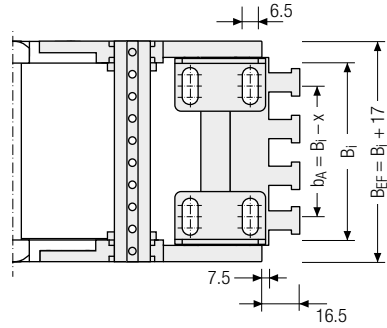
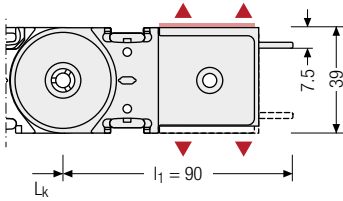

▲ Assembly options

B_i [mm]	x [mm]	n_z
40	17.5	3
56	21.5	4
80	17.5	6
104	19.0	8
128	19.5	9
152	17.5	11
192	18.5	14

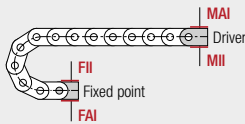

Connection point
F – fixed point
M – driver

Connection surface
I – connection surface inside

Connection type
A – threaded joint outside (standard)
I – threaded joint inside

Order example

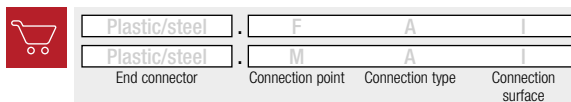

End connectors – plastic/steel

Plastic link end connector, steel end connector. The connection variants on the fixed point and on the driver can be combined and, if required, changed afterwards.

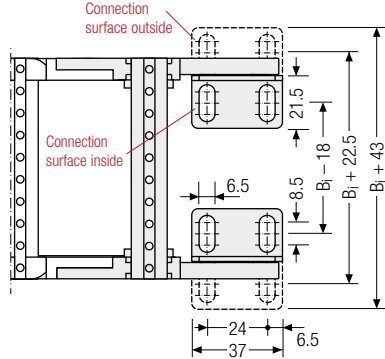
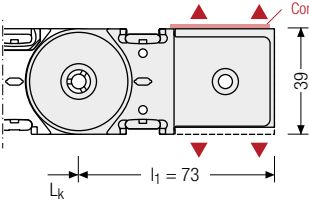

▲ Assembly options

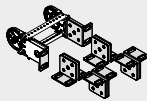
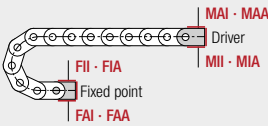

Connection point

- F – fixed point
- M – driver

Connection surface

- I – connection surface inside
- A – connection surface outside

Connection type

- A – threaded joint outside (standard)
- I – threaded joint inside
- F – flange connection

Order example

	Plastic/steel	F	A	A
	Plastic/steel	M	U	
	End connector	Connection point	Connection type	Connection surface

 We recommend the use of strain reliefs at the driver and fixed point. See from p. 904.

PROTUM® series
K series
UNIFLEX Advanced series
M series
XL series
QUANTUM® series
TKR series
TKA series
UAT series

M0650

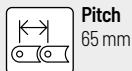

Pitch
65 mm



Inner heights
36 - 42 mm



Inner widths
50 - 600 mm

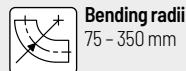

Bending radii
75 - 350 mm

Stay variants



Aluminum stay RS page 374

Frame stay, narrow "The standard"

- » Aluminum profile bars for light to medium loads. Assembly without screws.
- » **Outside/inside:** release by turning by 90°.

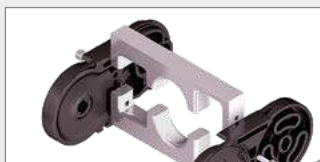

Aluminum stay LG page 378

Hole stay, split version

- » Optimum cable routing in the neutral bending line. Split version for easy cable routing. Stays also available unsplit.
- » **Outside/inside:** Screw-fixing easy to release.



Aluminum stay RMA page 380

Mounting frame stay

- » Aluminum profile bars with plastic mounting frame stays for guiding very large cable diameters.
- » **Outside/inside:** Screw-fixing easy to release.



Plastic stay RE page 382

Frame screw-in stay

- » Plastic profile bars for light to medium loads. Assembly without screws.
- » **Outside/inside:** release by turning by 90°.



Plastic stay RD page 383

Frame stay with hinge

- » Plastic profile bars with hinge for light to medium loads. Assembly without screws.
- » **Outside:** swivable to both sides.
- » **Inside:** release by turning by 90°.



Also available as covered variants with cover system.
More information can be found in chapter "MT series" from p. 612.

Unsupported arrangement

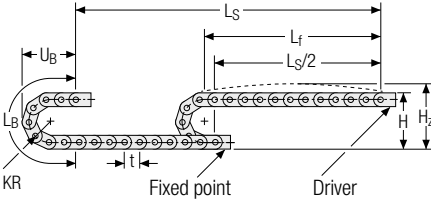

KR [mm]	H [mm]	H _z [mm]	L _B [mm]	U _B [mm]
75	207	242	366	169
95	247	282	429	189
115	287	322	492	209
145	347	382	586	239
175	407	442	680	269
220	497	532	822	314
260	577	612	948	354
275	607	642	994	369
300	657	692	1073	394
350	757	792	1230	444

Load diagram for unsupported length depending on the additional load.

Sagging of the cable carrier is technically permitted for extended travel lengths, depending on the specific application.

Intrinsic cable carrier weight $q_k = 2.4 \text{ kg/m}$. For other inner widths, the maximum additional load changes.

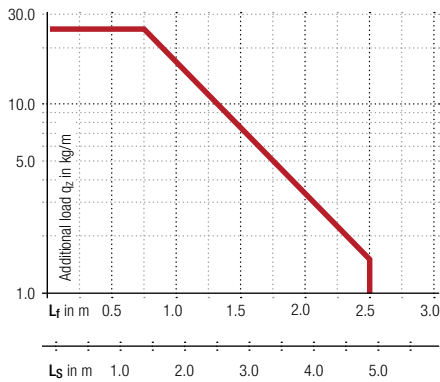

- Speed**
up to 10 m/s
- Acceleration**
up to 40 m/s²
- Travel length**
up to 4.8 m
- Additional load**
up to 25 kg/m

Gliding arrangement | GO module with chain links optimized for gliding

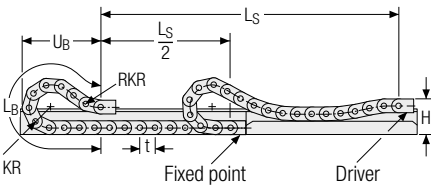

KR [mm]	H [mm]	GO module RKR [mm]	L _B [mm]	U _B [mm]
95	171	300	1180	560
115	171	300	1310	605
145	171	300	1440	640
175	171	300	1635	705
220	171	300	1950	810
260	171	300	2275	926
275	171	300	2405	973
300	171	300	2535	1014
350	171	300	2925	1152

- Speed**
up to 8 m/s
- Acceleration**
up to 20 m/s²
- Travel length**
up to 220 m
- Additional load**
up to 25 kg/m

The gliding cable carrier must be guided in a channel. See p. 844.

The GO module mounted on the driver is a defined sequence of 5 adapted KR/RKR link plates.

Gliding shoes have to be used for gliding applications.

PROTUM® series
K series
UNIFLEX Advanced series
M series
XL series
QUANTUM® series
TKR series
TKA series
UAT series

Aluminum stay RS – frame stay narrow

- Extremely quick to open and close
- Aluminum profile bars for light to medium loads.
Assembly without screws.
- Available customized in **1 mm grid**.
- **Outside/inside:** release by turning by 90°.



Stay arrangement on every
2nd chain link, **standard**
(HS: half-stayed)



Stay arrangement on each
chain link (**VS: fully-stayed**)



1 mm B_i 75 – 400 mm
in **1 mm** width sections

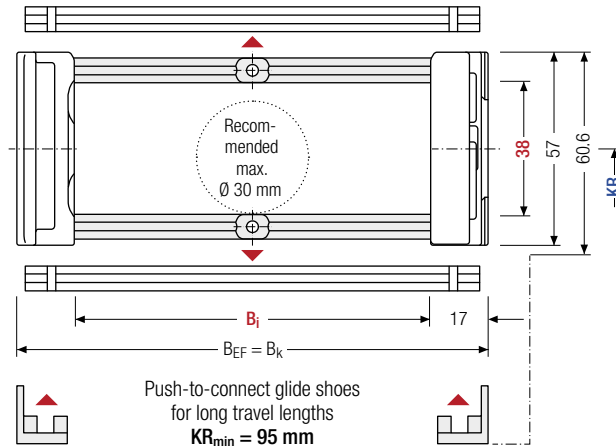

The maximum cable diameter strongly depends on the bending radius and the desired cable type. Please contact us.

For rough environmental conditions, we recommend the use of OFFROAD glide shoes with 80 % higher wear volume.

Calculating the cable carrier length

Cable carrier length L_k

$$L_k \approx \frac{L_s}{2} + L_B$$

Cable carrier length L_k
rounded to pitch t

h_i [mm]	h_G [mm]	h_G' [mm]	h_G' Offroad [mm]	B_i [mm]*	B_k [mm]	B_{EF} [mm]	KR [mm]			q_k [kg/m]		
38	57	60.6	62.2	75 – 400	$B_i + 34$	$B_i + 34$	75	95	115	145	175	1.98 – 3.85
							220	260	275	300	350	

* in 1 mm width sections

Order example



MC0650

Type

300

B_i [mm]

RS

Stay variant

175

KR [mm]

1430

L_k [mm]

HS

Stay arrangement

Divider systems

As a standard, the divider system is mounted on each crossbar – for stay mounting on every 2nd chain link (HS).
As a standard, dividers and the complete divider system (dividers with height separations) can be moved in the cross section (**version A**).

For applications with lateral acceleration and rotated by 90°, the dividers can be attached by simply clipping on a socket (available as an accessory).
The bushing additionally serves as a spacer between the dividers and is available in 1 mm sections between 3 – 50 mm. The inner height is reduced to 32 mm (**version B**).

Divider system TSO without height separation

Vers.	a _T min [mm]	a _x min [mm]	a _c min [mm]	n _T min
A	6.5	13	10	2

The dividers can be moved in the cross section.

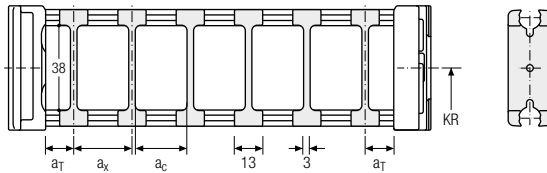

Divider system TS1 with continuous height separation

Vers.	a _T min [mm]	a _T max [mm]	a _x min [mm]	a _c min [mm]	n _T min
A	6.5	25	13	10	2

The dividers can be moved in the cross section.

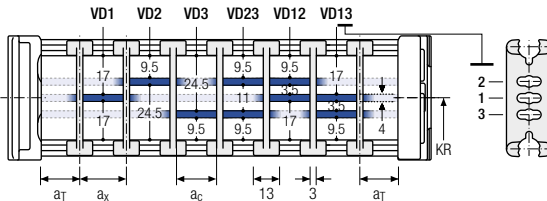

Divider system TS2 with partial height separation

Vers.	a _T min [mm]	a _x min [mm]	a _c min [mm]	n _T min
A	1.5	21	15	2

With grid distribution (1 mm grid).
The dividers are attached by the height separation, the grid can be moved in the cross section.

Sliding dividers are optionally available (thickness of divider = 3 mm).

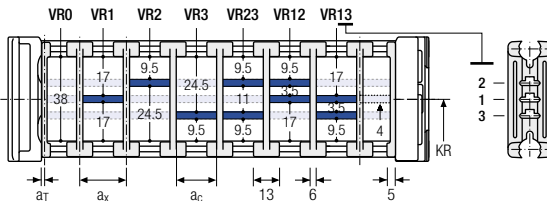

PROTUM® series
K series
UNIFLEX Advanced series
M series
XL series
QUANTUM® series
TKR series
TKA series
UAT series

Subject to change without notice.



TRAXLINE® cables for cable carriers
Hi-flex electric cables which were especially developed, optimized and tested for use in cable carriers can be found at tsubaki-kabelschlepp.com/traxline

Divider system TS3 with height separation made of plastic partitions

Vers.	a_T min [mm]	a_x min [mm]	a_c min [mm]	n_T min
A	4	16 / 42*	8	2

* For aluminum partitions

The dividers are fixed by the partitions, the complete divider system is movable in the cross section.

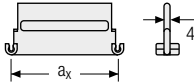
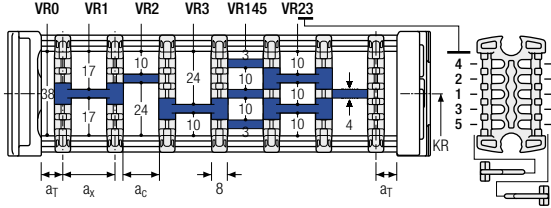

Aluminum partitions in 1 mm increments with $a_x > 42$ mm are also available.

a_x (center distance of dividers) [mm]											
a_c (nominal width of inner chamber) [mm]											
16	18	23	28	32	33	38	43	48	58	64	68
8	10	15	20	24	25	30	35	40	50	56	60
78	80	88	96	112	128	144	160	176	192	208	
70	72	80	88	104	120	136	152	168	184	200	

When using **plastic partitions with $a_x > 112$ mm**, we recommend an additional center support with a **twin divider** ($S_T = 3$ mm). Twin dividers are also suitable for retrofitting in the partition system.

Order example

	TS3	A	3	K1	34	VR1
				⋮	⋮	⋮
			K4	38	VR3	
Divider system	Version	n_T	Chamber	a_x	Height separation	

Please state the designation of the divider system (TS0, TS1 ...), version and number of dividers per cross section n_T . In addition, please also enter the chambers [K] from left to right, as well as the assembly distances $[a_T/a_x]$ (as seen from the driver).

If using divider systems with height separation (TS1, TS3) please also state the positions [e.g. VD23] viewed from the left driver belt. You are welcome to add a sketch to your order.

More product information online



Assembly instructions etc.:
Additional info via your
smartphone or check online at
[tsubaki-kabelschlepp.com/
support](http://tsubaki-kabelschlepp.com/support)



Configure your custom
cable carrier here:
online-engineer.de



PROTUM®
series

K
series

UNIFLEX
Advanced
series

M
series

XL
series

QUANTUM®
series

TKR
series

TKA
series

UAT
series

Aluminum stay LG – Hole stay, split version

- Optimum cable routing in the neutral bending line. Split version for easy cable routing. Stays also available unsplit.
- Available customized in **1 mm width sections**.
- **Outside/inside:** Screw-fixing easy to release.



Stay arrangement on every 2nd chain link, **standard** (HS: half-stayed)



Stay arrangement on each chain link (**VS: fully-stayed**)



1 mm B_i 75 – 600 mm in **1 mm width sections**

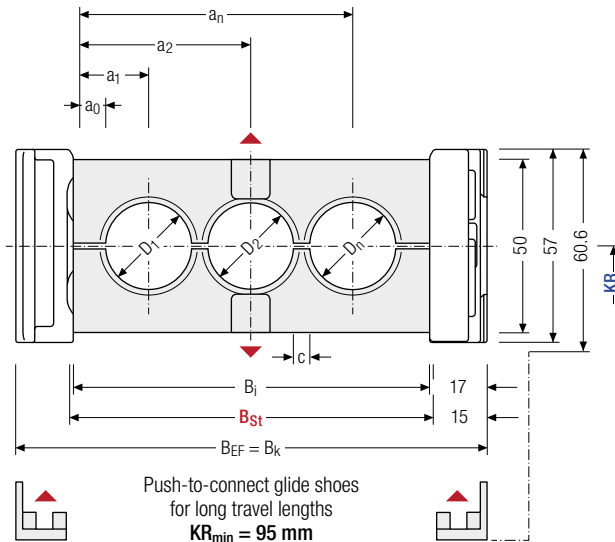

The maximum cable diameter strongly depends on the bending radius and the desired cable type. Please contact us.

Calculating the cable carrier length

Cable carrier length L_k

$$L_k \approx \frac{L_s}{2} + L_B$$

Cable carrier length L_k rounded to pitch t

Calculating the stay width

Stay width B_{St}

$$B_{St} = \sum D + \sum c + 2 a_0$$

D _{max} [mm]	D _{min} [mm]	h _G [mm]	B _i [mm]	B _{St} [mm]*	B _k [mm]	B _{EF} [mm]	c _{min} [mm]	a _{0 min} [mm]	KR [mm]				q _k 50 %** [kg/m]
36	9	57	75 – 600	79 – 604	B _{St} + 30	B _{St} + 30	4	10	75	95	115	145	2.39 – 4.66
									175	220	260	275	
									300	350			

* in 1 mm width sections

** Hole ratio of the hole stay approx. 50 %

Order example



MC0650

Type

300

B_i [mm]

LG

Stay variant

175

KR [mm]

1430

L_k [mm]

HS

Stay arrangement

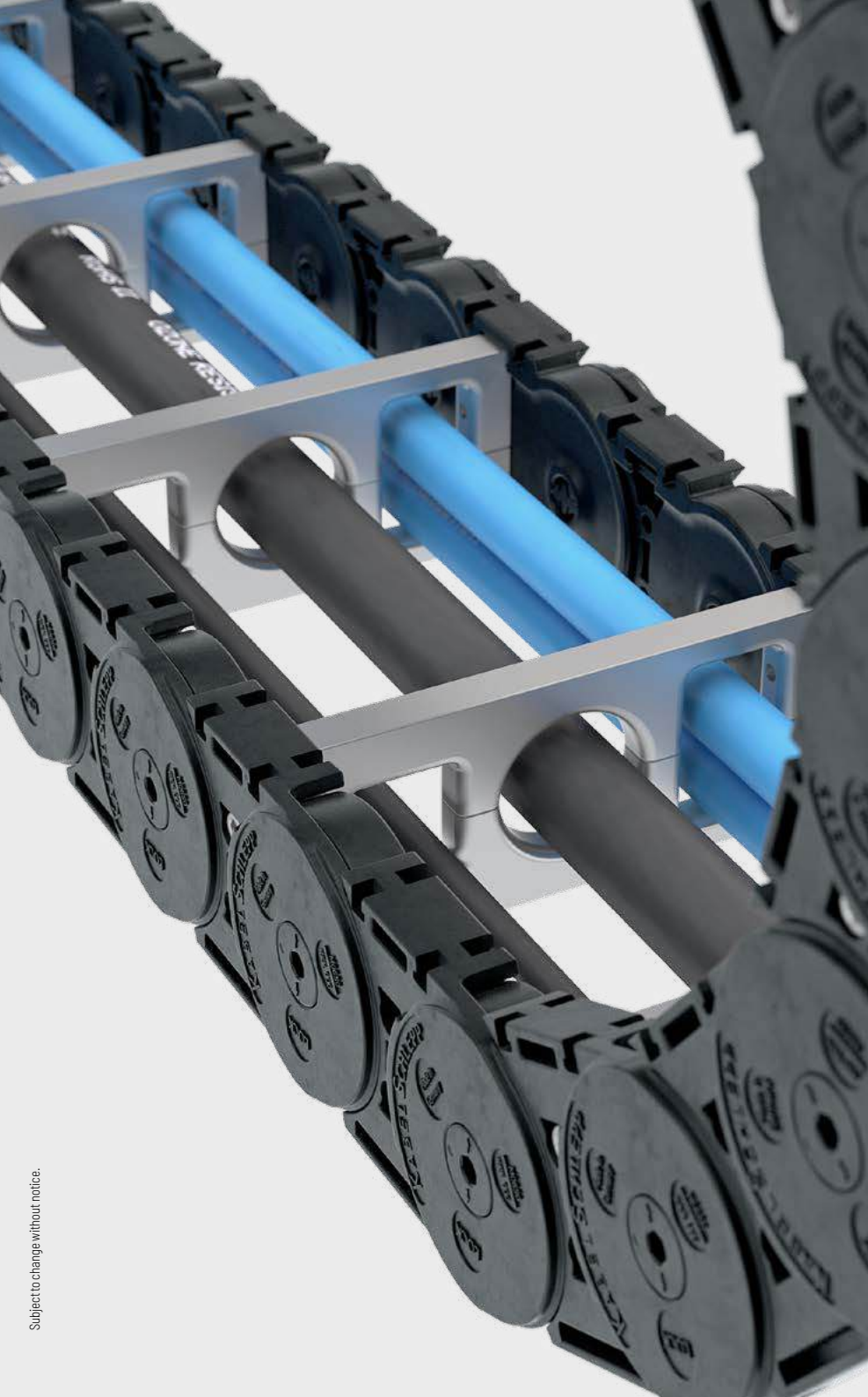

PROTUM®
series

K
series

UNIFLEX
Advanced
series

M
series

XL
series

QUANTUM®
series

TKR
series

TKA
series

UAT
series

Aluminum stay RMA – mounting frame stay

- Aluminum profile bars with plastic mounting frame stays for guiding very large cable diameters.
- The mounting frame stay can be mounted either inside or outside in the bending radius. Available customized in **1 mm width sections**.
- Outside/inside:** Screw-fixing easy to release.



Stay arrangement on every 2nd chain link, **standard** (HS: half-stayed)



Stay arrangement on each chain link (VS: fully-stayed)



B_i 200 – 400 mm in **1 mm width sections**

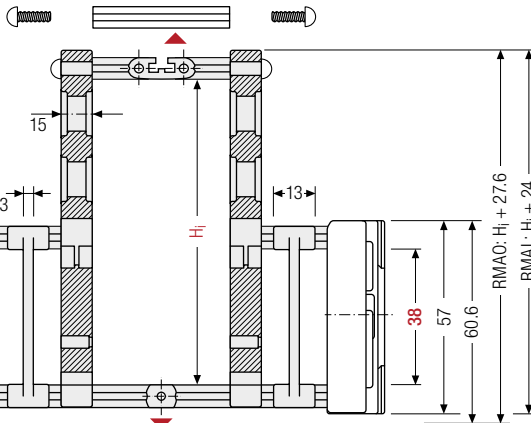

i The maximum cable diameter strongly depends on the bending radius and the desired cable type. Please contact us.

Calculating the cable carrier length

Cable carrier length L_k

$$L_k \approx \frac{L_s}{2} + L_B$$

Cable carrier length L_k rounded to pitch t

i Intrinsic cable carrier weight

Determining the intrinsic cable carrier weight strongly depends on the selected stay arrangement. Please contact us.

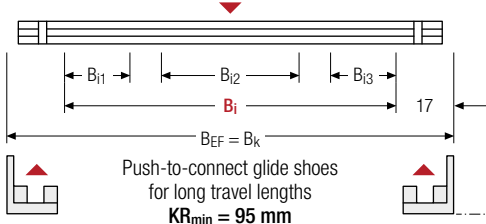

h_i [mm]	H_i [mm]	h_G [mm]	B_i [mm]	B_{i1} min [mm]	B_{i3} min [mm]	B_k [mm]	B_{EF} [mm]	KR [mm]				
38	130 160 200	57	200 – 400	16	16	$B_i + 34$	$B_i + 34$	75	95	115	145	175
								220	260	275	300	350

Order example



MC0650

Type

300

B_i [mm]

RMAO

Stay variant

175

KR [mm]

1430

L_k [mm]

HS

Stay arrangement

Assembly variants

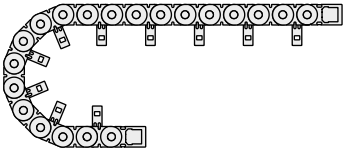

RMAI – assembly to the inside:

Gliding application is not possible when using assembly version RMAI.

Observe minimum KR:

H_i = 130 mm: KR_{min} = 220 mm

H_i = 160 mm: KR_{min} = 300 mm

H_i = 200 mm: KR_{min} = 300 mm

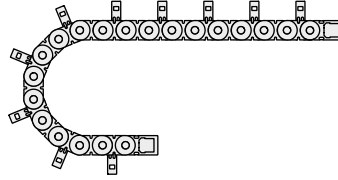

RMAO – assembly to the outside:

The cable carrier has to rest on the side bands and not on the stays.

Guiding in a **channel is required** for support.

Please contact our technical support at technik@kabelschlepp.de to find the corresponding guide channel.

Please note the operating and installation height.



Subject to change without notice.

PROTUM® series
K series
UNIFLEX Advanced series
M series
XL series
QUANTUM® series
TKR series
TKA series
UAT series

Plastic stay RE – screw-in frame stay

- Plastic profile bars for light to medium loads.
Assembly without screws.
- Available customized in **8 mm grid**.
- **Outside/inside:** release by turning by 90°.



Stay arrangement on every
2nd chain link, **standard**
(**HS: half-stayed**)



Stay arrangement on each
chain link (**VS: fully-stayed**)



8 mm B_i 50 – 266 mm
in **8 mm width sections**

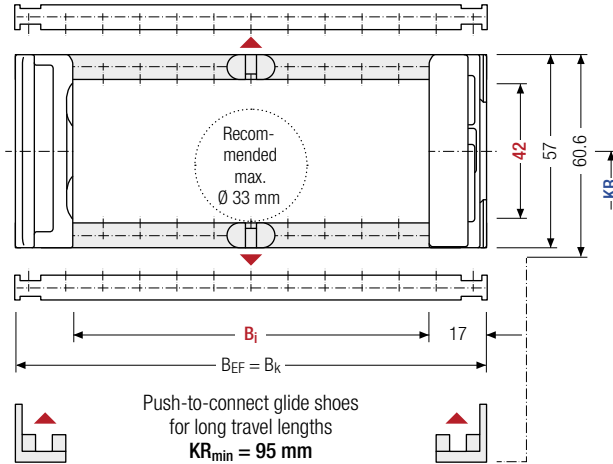

The maximum cable diameter strongly depends on the bending radius and the desired cable type. Please contact us.

For rough environmental conditions, we recommend the use of OFFROAD glide shoes with 80 % higher wear volume.

Calculating the cable carrier length

Cable carrier length L_k

$$L_k \approx \frac{L_s}{2} + L_B$$

Cable carrier length L_k
rounded to pitch t

h _i [mm]	h _G [mm]	h _{G'} [mm]	h _{G'} Offroad [mm]	B _i [mm]					B _K [mm]	B _{EF} [mm]	KR [mm]		q _k [kg/m]	
42	57	60.6	62.2	50	58	66	74	82	90	B _i + 34	B _i + 34	75	95	2.00 – 2.84
				98	106	114	122	130	138			115	145	
				146	154	162	170	178	186			175	220	
				194	202	210	218	226	234			260	275	
				242	250	258	266			300	350			

Order example



ME0650

Type

210

B_i [mm]

RE

Stay variant

175

KR [mm]

1430

L_k [mm]

HS

Stay arrangement

Plastic stay RD – Frame stay with hinge

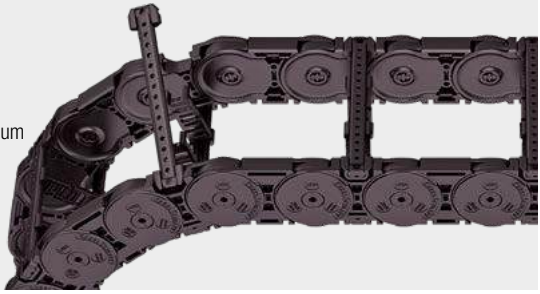

- Plastic profile bars with hinge for light to medium loads. Assembly without screws.
- Available customized in **8 mm grid**.
- **Outside:** swivable to both sides.
- **Inside:** release by turning by 90°.

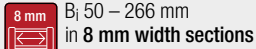
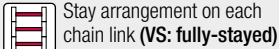
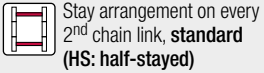

PROTUM® series

K series

UNIFLEX Advanced series

M series

XL series

QUANTUM® series

TKR series

TKA series

UAT series

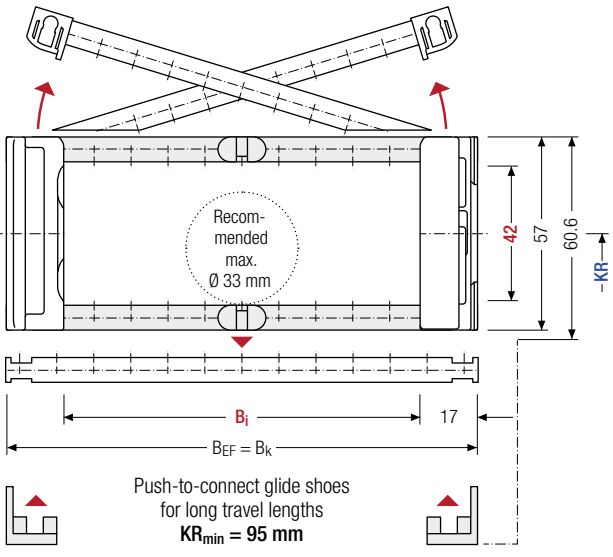

i The maximum cable diameter strongly depends on the bending radius and the desired cable type. Please contact us.

i For rough environmental conditions, we recommend the use of OFFROAD glide shoes with 80 % higher wear volume.

Calculating the cable carrier length

Cable carrier length L_k

$$L_k \approx \frac{L_s}{2} + L_B$$

Cable carrier length L_k rounded to pitch t

h _i [mm]	h _G [mm]	h _{G'} [mm]	h _{G'} Offroad [mm]	B _i [mm]						B _k [mm]	B _{EF} [mm]	KR [mm]		q _k [kg/m]	
42	57	60.6	62.2	50	58	66	74	82	90	B _i + 34	B _i + 34	75	95	2.00	
				98	106	114	122	130	138			115	145		
				146	154	162	170	178	186			175	220		–
				194	202	210	218	226	234			260	275		
				242	250	258	266	300	350			2.84			

Order example

MK0650 ·
 210 ·
 RD ·
 175 ·
 1430 ·
 HS
 Type B_i [mm] Stay variant KR [mm] L_k [mm] Stay arrangement

Subject to change without notice.

Divider systems

As a standard, the divider system is mounted on each crossbar – for stay mounting on every 2nd chain link (HS).

As a standard, dividers and the complete divider system (dividers with height separations) can be moved in the cross section (**version A**).

The dividers are easily attached to the stay for applications with lateral acceleration and for applications laying on their side by simply turning the frame stay by 180°. The arresting cams click into place in the locking grids in the crossbars (**version B**). The groove in the frame stay faces outwards.

Divider system TSO without height separation

Vers.	a_T min [mm]	a_x min [mm]	a_c min [mm]	a_x Raster [mm]	n_T min
A	6.5	13	8.8	–	–
B	13	16	11.8	8	–

The dividers can be moved within the cross section (version A) or fixed (version B).

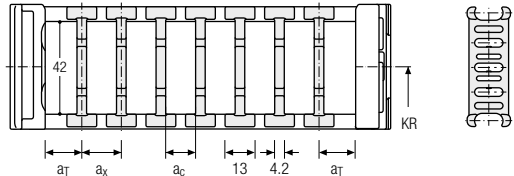

Divider system TS1 with continuous height separation

Vers.	a_T min [mm]	a_T max [mm]	a_x min [mm]	a_c min [mm]	a_x Raster [mm]	n_T min
A	6.5	25	13	8.8	–	2

The dividers can be moved within the cross section.

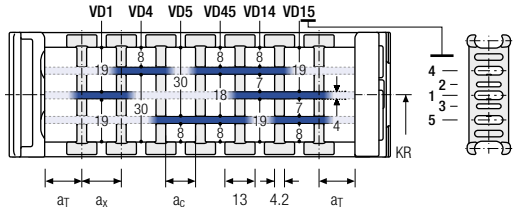

TOTALTRAX® complete systems

Benefit from the advantages of the TOTALTRAX® complete system. A complete delivery from one source – with a warranty certificate on request! Learn more at tsubaki-kabelschlepp.com/totaltrax

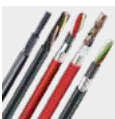

TRAXLINE® cables for cable carriers

Hi-flex electric cables which were especially developed, optimized and tested for use in cable carriers can be found at tsubaki-kabelschlepp.com/traxline

Divider system TS3 with height separation made of plastic partitions

Vers.	a _T min [mm]	a _x min [mm]	a _c min [mm]	n _T min
A	4	16 / 42*	8	2

* For aluminum partitions

The dividers are fixed by the partitions, the complete divider system is movable in the cross section.

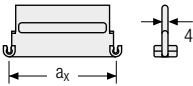
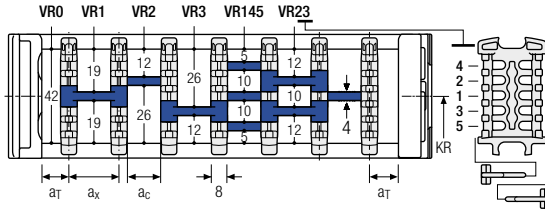

Aluminum partitions in 1 mm increments with a_x > 42 mm are also available.

a _x (center distance of dividers) [mm]											
a _c (nominal width of inner chamber) [mm]											
16	18	23	28	32	33	38	43	48	58	64	68
8	10	15	20	24	25	30	35	40	50	56	60
78	80	88	96	112	128	144	160	176	192	208	
70	72	80	88	104	120	136	152	168	184	200	

When using plastic partitions with a_x > 112 mm, we recommend an additional center support with a twin divider (S_T = 3 mm). Twin dividers are also suitable for retrofitting in the partition system.

Order example

TS3

A

2

K1

34

VR1

⋮
 ⋮
 ⋮

K4

38

VR3

Divider system
Version
n_T
Chamber
a_x
Height separation

Please state the designation of the divider system (TS0, TS1 ...), version and number of dividers per cross section [n_T]. In addition, please also enter the chambers [K] from left to right, as well as the assembly distances [a_T/a_x] (as seen from the driver).

If using divider systems with height separation (TS1, TS3) please also state the positions [e.g. VD23] viewed from the left driver belt. You are welcome to add a sketch to your order.

More product information online



Assembly instructions etc.: Additional info via your smartphone or check online at tsubaki-kabelschlepp.com/downloads



Configure your custom cable carrier: here online-engineer.de

- PROTUM® series
- K series
- UNIFLEX Advanced series
- M series
- XL series
- QUANTUM® series
- TKR series
- TKA series
- UAT series

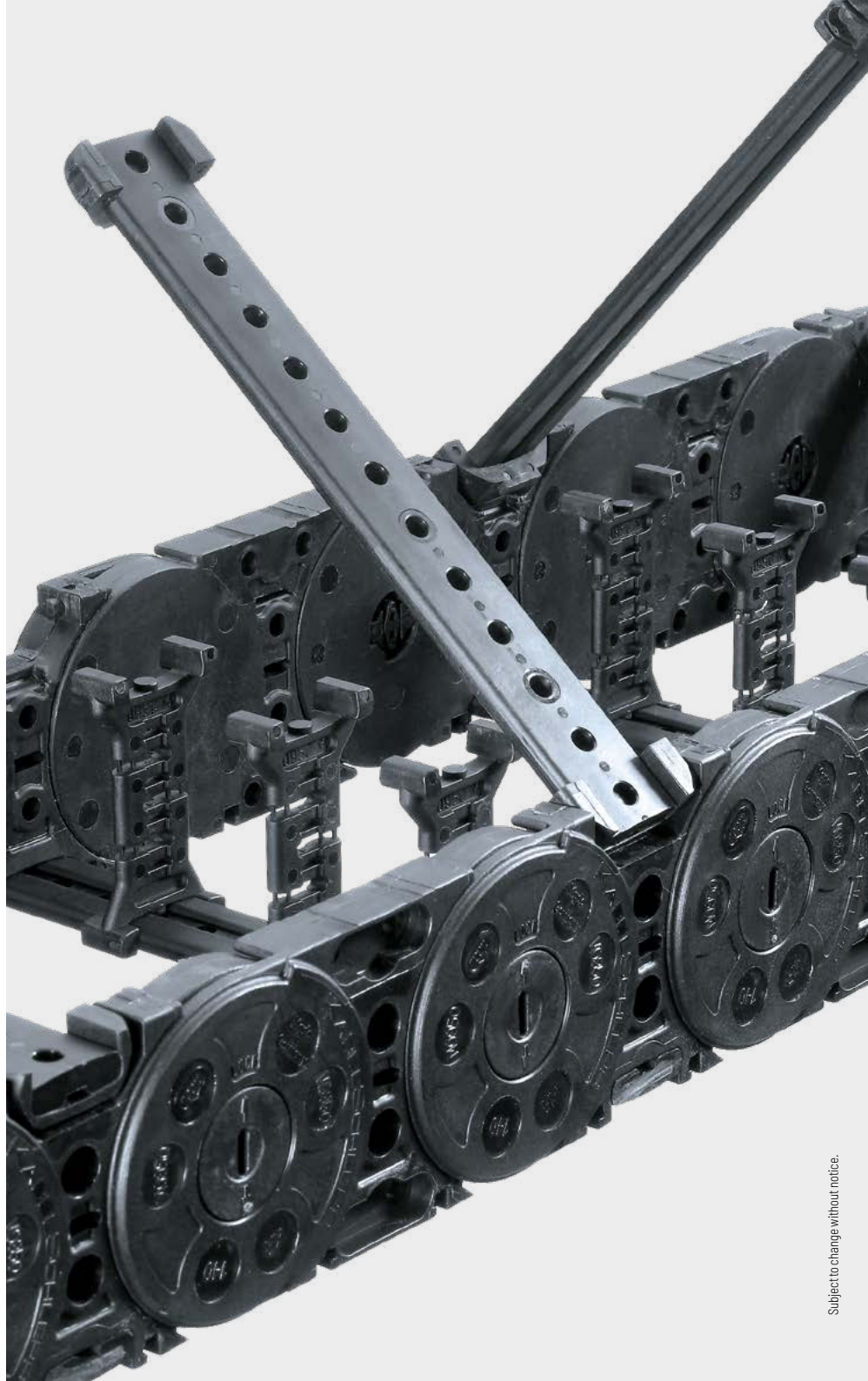
PROTUM®
seriesK
seriesUNIFLEX
Advanced
series**M**
seriesXL
seriesQUANTUM®
seriesTKR
seriesTKA
seriesUAT
series

Universal end connectors UMB – plastic (standard)

The universal mounting brackets (UMB) are made from plastic and can be mounted **from the top, from the bottom, face on or from the side.**

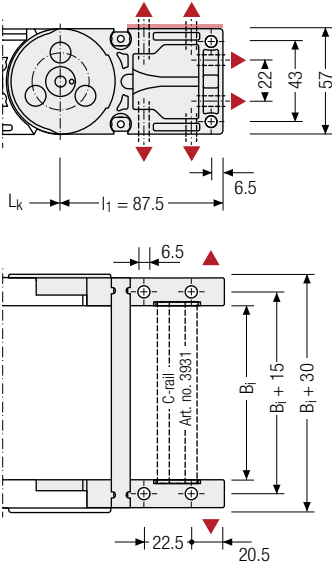

Recommended tightening torque: 11 Nm for cheese-head screws ISO 4762 - M6 - 8.8

End connectors – plastic/steel

Plastic link end connector, steel end connector. The connection variants on the fixed point and on the driver can be combined and, if required, changed afterwards.

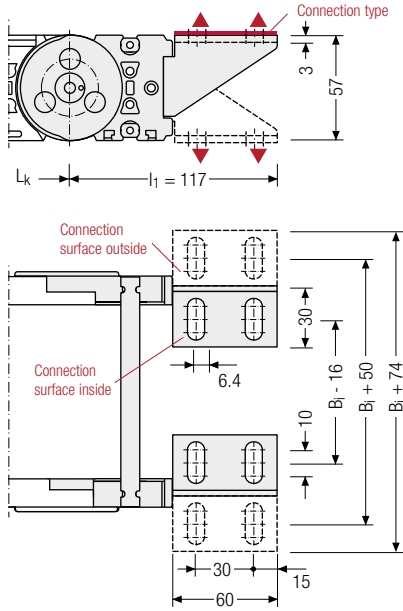

Assembly options

Connection point

- F – fixed point
- M – driver

Connection type

- U – universal mounting bracket

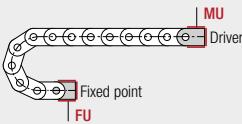

Connection point

- F – fixed point
- M – driver

Connection surface

- I – connection surface inside
- A – connection surface outside

Connection type

- A – threaded joint outside (standard)
- I – threaded joint inside
- F – flange connection

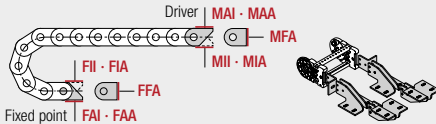

Order example

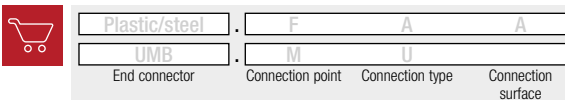

We recommend the use of strain reliefs at the driver and fixed point. See from p. 904.

PROTUM® series

K series

UNIFLEX Advanced series

M series

XL series

QUANTUM® series

TKR series

TKA series

UAT series

M0950

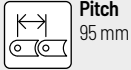

Pitch
95 mm



Inner heights
50 – 58 mm



Inner widths
45 – 600 mm



Bending radii
140 – 380 mm

Stay variants

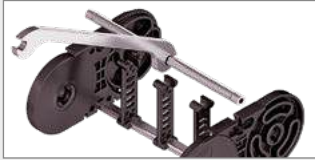

Aluminum stay RS page **392**

Frame stay, narrow "The standard"

- » Aluminum profile bars for light to medium loads. Assembly without screws.
- » **Outside/inside:** release by turning by 90°.



Aluminum stay RV page **396**

Frame stay, reinforced

- » Aluminum profile bars with plastic adapter for medium to high loads and large cable carrier widths. Assembly without screws.
- » **Outside/inside:** release by turning by 90°.

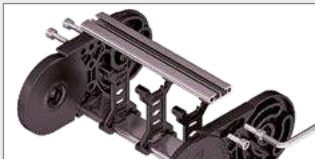

Aluminum stay RM page **400**

Frame stay, solid

- » Aluminum profile bars for heavy loads and maximum cable carrier widths. Double threaded joints on both sides "Heavy Duty".
- » **Inside/outside:** Threaded joint easy to release.



Aluminum stay LG page **402**

Hole stay, split version

- » Optimum cable routing in the neutral bending line. Split version for easy cable routing. Stays also available unsplit.
- » **Outside/inside:** Screw-fixing easy to release.



TRAXLINE® cables for cable carriers

Hi-flex electric cables which were specially developed, optimised and tested for use in cable carriers can be found at tsubaki-kabelschlepp.com/traxline.

Stay variants

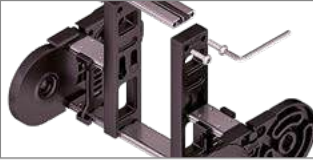

Aluminum stay RMA page 404

Mounting frame stay

- » Aluminum profile bars with plastic mounting frame stays for guiding very large cable diameters.
- » **Outside/inside:** Screw-fixing easy to release.



Aluminum stay RMR page 406

Frame rolling stay

- » Aluminum profile bars with rotating plastic rolling stay for highest requirements with gentle cable guiding. Double threaded joint on both sides.
- » **Inside/outside:** threaded joint easy to release.



Plastic stay RE page 408

Frame screw-in stay

- » Plastic profile bars for light to medium loads. Assembly without screws.
- » **Outside/inside:** release by turning by 90°.



Plastic stay RD page 409

Frame stay with hinge

- » Plastic profile bars with hinge for light to medium loads. Assembly without screws.
- » **Outside:** swivable to both sides.
- » **Inside:** release by turning by 90°.

MT series

Also available as covered variants with cover system.
More information can be found in chapter "MT series" from p. 612.



PROTUM®
series

K
series

UNIFLEX
Advanced
series

M
series

XL
series

QUANTUM®
series

TKR
series

TKA
series

UAT
series



Unsupported arrangement

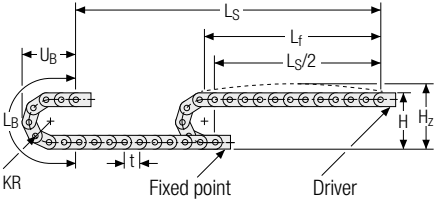

KR [mm]	H [mm]	H _z [mm]	L _B [mm]	U _B [mm]
140	360	405	630	275
170	420	465	725	305
200	480	525	819	335
260	600	645	1007	395
290	660	705	1102	425
320	720	765	1196	445
380	840	885	1384	515

Load diagram for unsupported length depending on the additional load.

Sagging of the cable carrier is technically permitted for extended travel lengths, depending on the specific application.

Intrinsic cable carrier weight $q_k = 4.5 \text{ kg/m}$. For other inner widths, the maximum additional load changes.

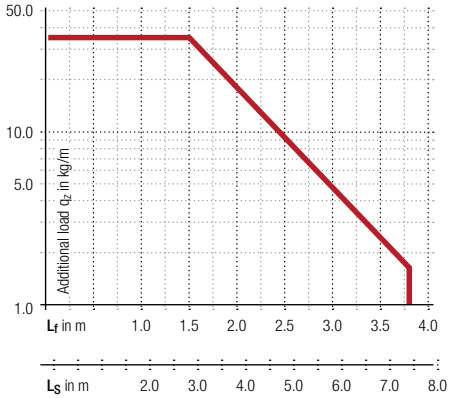

Speed
up to 10 m/s

Acceleration
up to 30 m/s²

Travel length
up to 7.4 m

Additional load
up to 35 kg/m

Gliding arrangement | GO module with chain links optimized for gliding

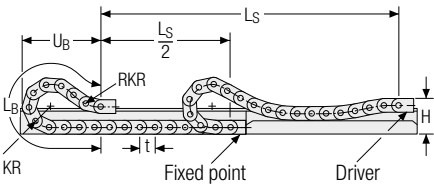

KR [mm]	H [mm]	GO module RKR [mm]	L _B [mm]	U _B [mm]
140	240	500	1580	740
170	240	500	1710	773
200	240	500	1995	888
260	240	500	2565	1114
290	240	500	2755	1183
320	240	500	3040	1296
380	240	500	3610	1523

Speed
up to 8 m/s

Acceleration
up to 20 m/s²

Travel length
up to 260 m

Additional load
up to 35 kg/m

The gliding cable carrier must be guided in a channel. See p. 844.

The GO module mounted on the driver is a defined sequence of 4 adapted KR/RKR link plates.

Gliding shoes have to be used for gliding applications.



Our technical support can provide help for gliding arrangements:
technik@kabelschlepp.de

PROTUM® series
K series
UNIFLEX Advanced series
M series
XL series
QUANTUM® series
TKR series
TKA series
UAT series

Aluminum stay RS – frame stay narrow

- Extremely quick to open and close
- Aluminum profile bars for light to medium loads.
Assembly without screws.
- Available customized in **1 mm** grid.
- **Outside/inside:** release by turning by 90°.

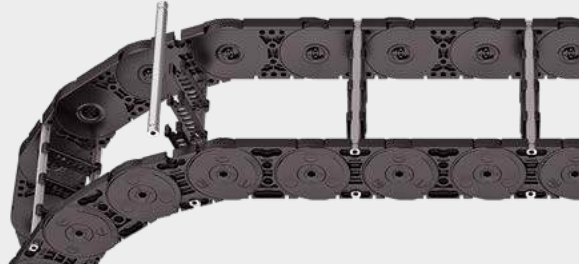

Stay arrangement on every
2nd chain link, **standard**
(HS: half-stayed)



Stay arrangement on each
chain link (VS: fully-stayed)



1 mm B_i 75 – 400 mm
in **1 mm** width sections

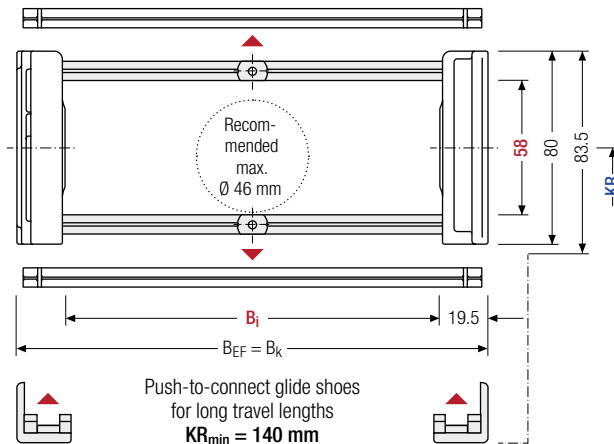

The maximum cable diameter strongly depends on the bending radius and the desired cable type. Please contact us.



For rough environmental conditions, we recommend the use of OFFROAD glide shoes with 80 % higher wear volume.

Calculating the cable carrier length

Cable carrier length L_k

$$L_k \approx \frac{L_s}{2} + L_B$$

Cable carrier length L_k
rounded to pitch t

h _i [mm]	h _G [mm]	h _G ' [mm]	h _G ' Offroad [mm]	B _i [mm]*	B _k [mm]	B _{EF} [mm]	KR [mm]				q _k [kg/m]
58	80	83.5	86	75 – 400	B _i + 39	B _i + 39	140	170	200	260	2.93 – 4.71
							290	320	380		

* in 1 mm width sections

Order example



MC0950

Type

400

B_i [mm]

RS

Stay variant

200

KR [mm]

2850

L_k [mm]

HS

Stay arrangement

Divider systems

As a standard, the divider system is mounted on each crossbar – for stay mounting on every 2nd chain link (HS).

As a standard, dividers and the complete divider system (dividers with height separations) can be moved in the cross section (**version A**).

For applications with lateral acceleration and rotated by 90°, the dividers can be attached by simply clipping on a socket (available as an accessory).

The socket additionally serves as a spacer between the dividers and is available in 1 mm sections between 3 – 50 mm. The inner height is reduced to 54 mm (**version B**).

Divider system TSO without height separation

Vers.	a _T min [mm]	a _x min [mm]	a _c min [mm]	π _T min
A	4.5	14	10	2

The dividers can be moved in the cross section.

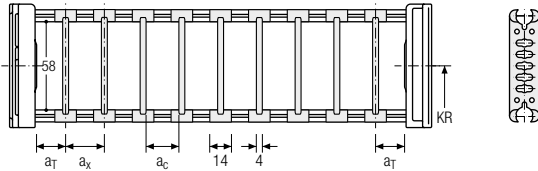

Divider system TS1 with continuous height separation

Vers.	a _T min [mm]	a _T max [mm]	a _x min [mm]	a _c min [mm]	π _T min
A	4.5	25	14	10	2

The dividers can be moved in the cross section.

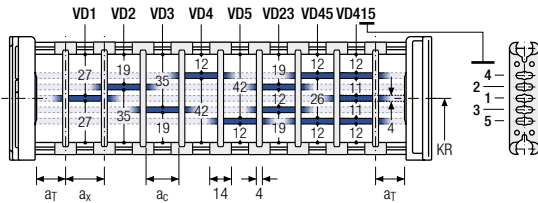

Divider system TS2 with partial height separation

Vers.	a _T min [mm]	a _x min [mm]	a _c min [mm]	π _T min
A	4.5	23	19	2

With grid distribution (1 mm grid). The dividers are attached by the height separation, the grid can be moved in the cross section.

Sliding dividers are optionally available (thickness of divider = 4 mm).

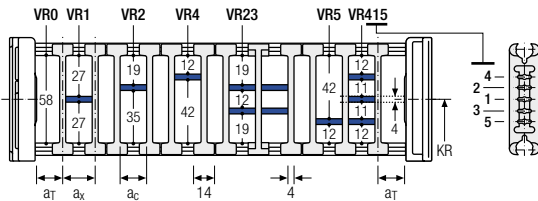

Please note that the real dimensions may deviate slightly from the values indicated here.

Order example

TS2

A

3

K1

34

VR1

K4

38

VR3

Divider system
Version
π_T
Chamber
a_x
Height separation

PROTUM® series
K series
UNIFLEX Advanced series
M series
XL series
QUANTUM® series
TKR series
TKA series
UAT series

Divider system TS3 with height separation consisting of plastic partitions

As a standard, the divider **version A** is used for vertical partitioning within the cable carrier. The complete divider system can be moved within the cross section.

PROTUM® series

K series

Divider version A

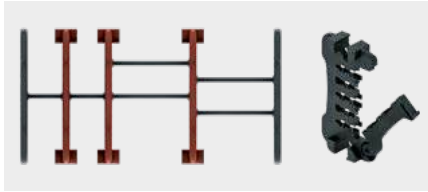

End divider

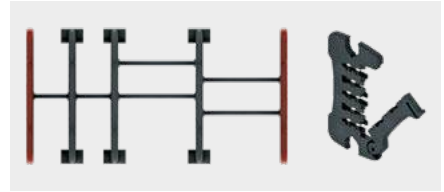

UNIFLEX Advanced series

M series

Vers.	a _T min [mm]	a _x min [mm]	a _c min [mm]	n _T min
A	6/2*	14	10	2

* For End divider

The dividers are fixed by the partitions, the complete divider system is movable in the cross section.

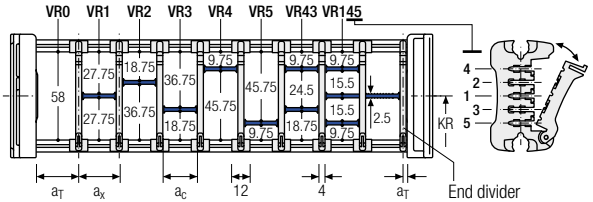

XL series

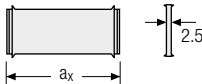

a _x (center distance of dividers) [mm]																
a _c (nominal width of inner chamber) [mm]																
14	16	19	23	24	28	29	32	33	34	38	39	43	44	48	49	54
10	12	15	19	20	24	25	28	29	30	34	35	39	40	44	45	50
58	59	64	68	69	74	78	79	80	84	88	89	94	96	99	112	
54	55	60	64	65	70	74	75	76	80	84	85	90	92	95	108	

When using partitions with a_x > 49 mm we recommended an additional preferential central support.

QUANTUM® series

TKR series

Order example

TS3 .
 A .
 3 .
 K1 .
 34 -
 VR1
 ⋮
 ⋮
 ⋮
K4 .
 38 -
 VR3

Divider system Version n_T Chamber a_x Height separation

TKA series

Please state the designation of the divider system (TS0, TS1,...), version and number of dividers per cross section [n_T]. In addition, please also enter the chambers [K] from left to right, as well as the assembly distances [a_T/a_x] (as seen from the driver).

If using divider systems with height separation (TS1, TS3) please also state the positions [e.g. VD23] viewed from the left driver belt. You are welcome to add a sketch to your order.

UAT series



PROTUM®
series

K
series

UNIFLEX
Advanced
series

M
series

XL
series

QUANTUM®
series

TKR
series

TKA
series

UAT
series

Aluminum stay RV – frame stay reinforced

- Aluminum profile bars with plastic adapter for medium to high loads and large cable carrier widths. Assembly without screws.
- Available customized in **1 mm grid**.
- **Outside/inside:** release by turning by 90°.

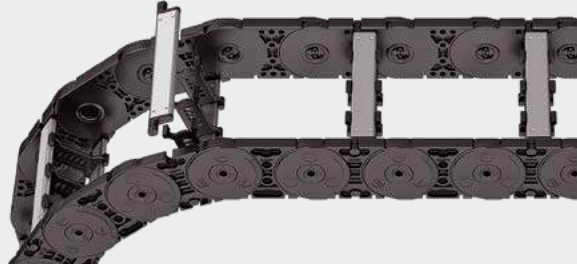

Stay arrangement on every 2nd chain link, **standard (HS: half-stayed)**



Stay arrangement on each chain link (**VS: fully-stayed**)



1 mm B_i 75 – 500 mm
in **1 mm width sections**

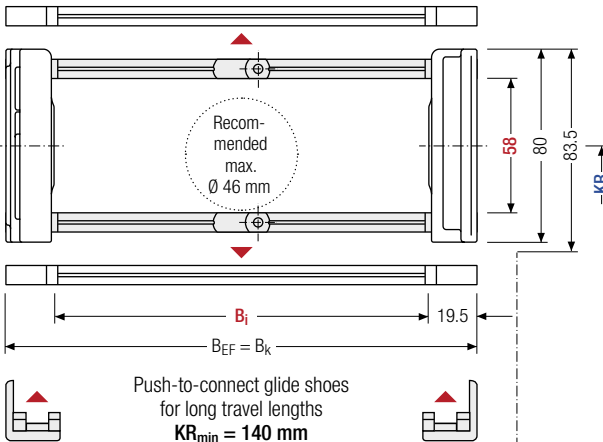

The maximum cable diameter strongly depends on the bending radius and the desired cable type. Please contact us.

For rough environmental conditions, we recommend the use of OFFROAD glide shoes with 80 % higher wear volume.

Calculating the cable carrier length

Cable carrier length L_k

$$L_k \approx \frac{L_s}{2} + L_B$$

Cable carrier length L_k rounded to pitch t

h _i [mm]	h _G [mm]	h _{G'} [mm]	h _{G'} Offroad [mm]	B _i [mm]*	B _k [mm]	B _{EF} [mm]	KR [mm]				q _k [kg/m]
58	80	83.5	86	75 – 500	B _i + 39	B _i + 39	140	170	200	260	3.32 – 6.02
							290	320	380		

* in 1 mm width sections

Order example



MC0950

Type

400

B_i [mm]

RV

Stay variant

200

KR [mm]

2850

L_k [mm]

HS

Stay arrangement

Divider systems

As a standard, the divider system is mounted on each crossbar – for stay mounting on every 2nd chain link (HS).

As a standard, dividers and the complete divider system (dividers with height separations) can be moved in the cross section (**version A**).

Divider system TSO without height separation

Vers.	a _T min [mm]	a _x min [mm]	a _c min [mm]	π _T min
A	4.5	14	10	2

The dividers can be moved in the cross section.

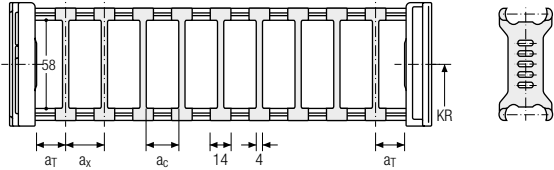

Divider system TS1 with continuous height separation

Vers.	a _T min [mm]	a _T max [mm]	a _x min [mm]	a _c min [mm]	π _T min
A	4.5	25	14	10	2

The dividers can be moved in the cross section.

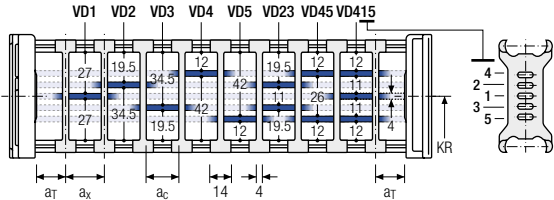

Divider system TS2 with partial height separation

Vers.	a _T min [mm]	a _x min [mm]	a _c min [mm]	π _T min
A	5.5	21	15	2

With grid distribution (1 mm grid). The dividers are attached by the height separation, the grid can be moved in the cross section.

Sliding dividers are optionally available (thickness of divider = 4 mm).

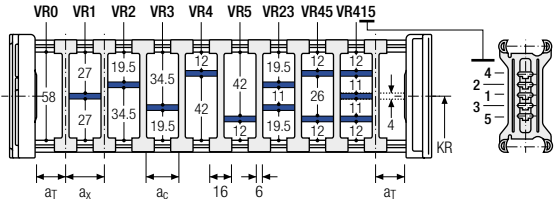

PROTUM® series
K series
UNIFLEX Advanced series
M series
XL series
QUANTUM® series
TKR series
TKA series
UAT series



TOTALTRAX® complete systems

Benefit from the advantages of the TOTALTRAX® complete system. A complete delivery from one source – with a warranty certificate on request! Learn more at tsbaki-kabelschlepp.com/totaltrax



TRAXLINE® cables for cable carriers

Hi-flex electric cables which were especially developed, optimized and tested for use in cable carriers can be found at tsbaki-kabelschlepp.com/traxline

Divider system TS3 with height separation made of plastic partitions

Vers.	a_T min [mm]	a_x min [mm]	a_c min [mm]	n_T min
A	4	16 / 42*	8	2

* For aluminum partitions

The dividers are fixed by the partitions, the complete divider system is movable in the cross section.

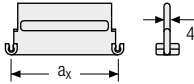

Aluminum partitions in 1 mm increments with $a_x > 42$ mm are also available.

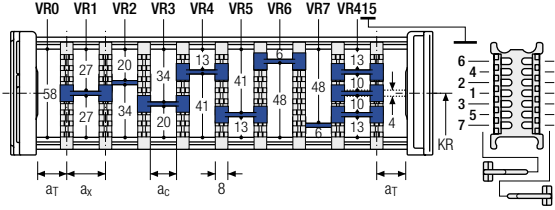

a_x (center distance of dividers) [mm]											
a_c (nominal width of inner chamber) [mm]											
16	18	23	28	32	33	38	43	48	58	64	68
8	10	15	20	24	25	30	35	40	50	56	60
78	80	88	96	112	128	144	160	176	192	208	
70	72	80	88	104	120	136	152	168	184	200	

When using **plastic partitions with $a_x > 112$ mm**, we recommend an additional center support with a **twin divider** ($S_T = 4$ mm). Twin dividers are also suitable for retrofitting in the partition system.

Order example



TS3	A	3	K1	34	VR1
			⋮	⋮	⋮
			K4	38	VR3
Divider system	Version	n_T	Chamber	a_x	Height separation

Please state the designation of the divider system (**TS0, TS1 ...**), version and number of dividers per cross section [n_T]. In addition, please also enter the chambers [K] from left to right, as well as the assembly distances [a_T/a_x] (as seen from the driver).

If using divider systems with height separation (**TS1, TS3**) please also state the positions [e.g. VD23] viewed from the left driver belt. You are welcome to add a sketch to your order.

More product information online



Assembly instructions etc.:
Additional info via your
smartphone or check online at
[tsubaki-kabelschlepp.com/
downloads](https://tsubaki-kabelschlepp.com/downloads)



Configure your custom
cable carrier here:
online-engineer.de

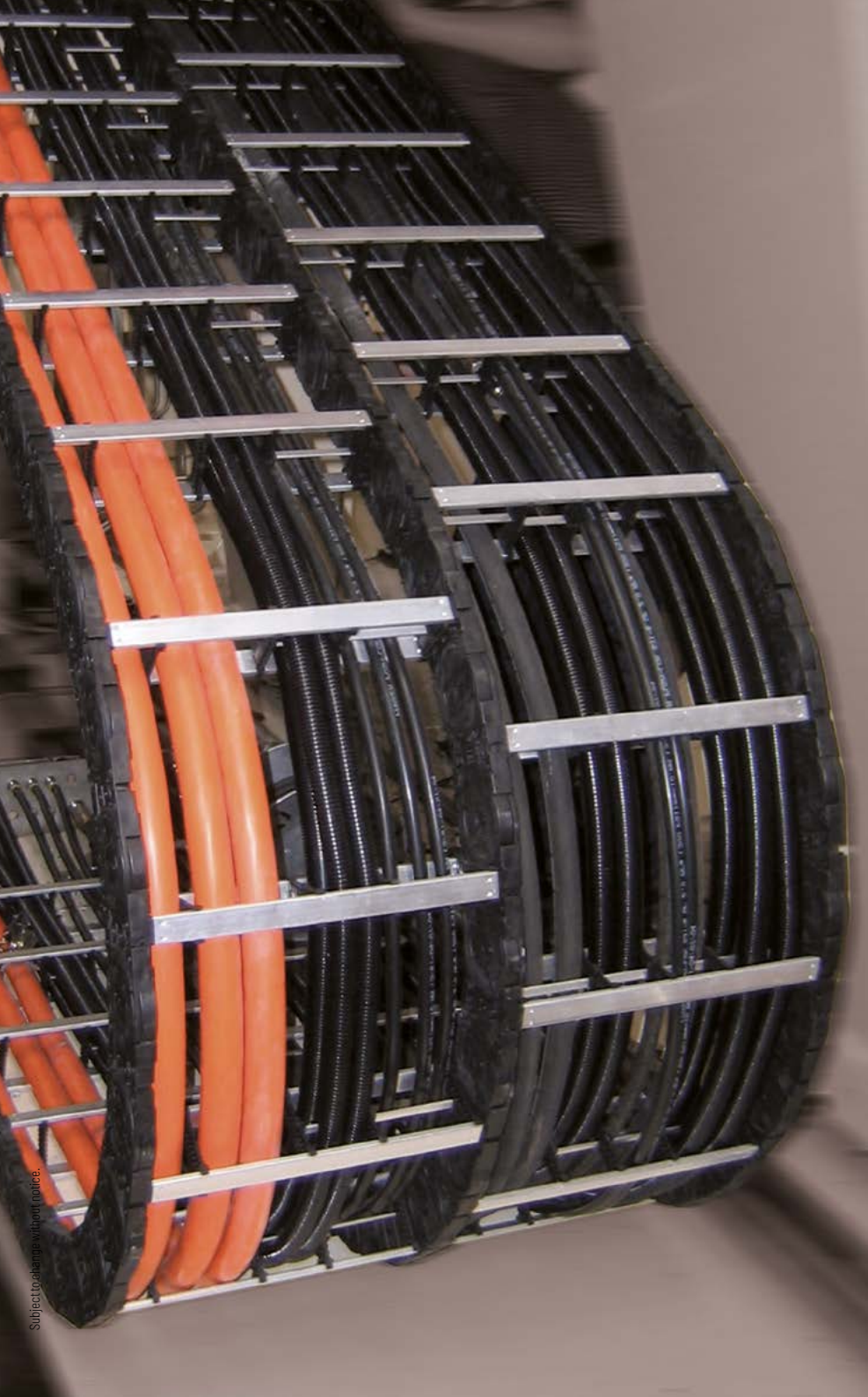

Subject to change without notice.

UAT
series

TKA
series

TKR
series

QUANTUM®
series

XL
series

M
series

UNIFLEX
Advanced
series

K
series

PROTUM®
series

Aluminum stay RM – frame stay solid

- Aluminum profile bars for heavy loads and maximum cable carrier widths. Double threaded joints on both sides “**Heavy Duty**”.
- Available customized in **1 mm grid**.
- **Inside/outside:** Threaded joint easy to release.

HEAVY DUTY
TSUBAKI KABELSCHLEPP

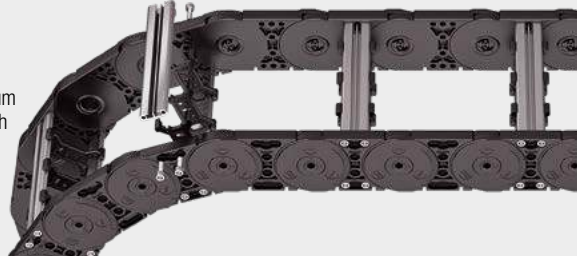

Stay arrangement on every 2nd chain link, **standard (HS: half-stayed)**



Stay arrangement on each chain link (**VS: fully-stayed**)



1 mm B_i 75 – 600 mm
in **1 mm width sections**

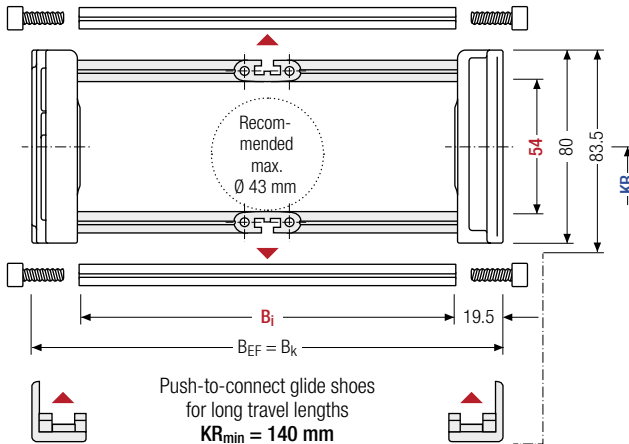

The maximum cable diameter strongly depends on the bending radius and the desired cable type. Please contact us.



For rough environmental conditions, we recommend the use of OFFROAD glide shoes with 80 % higher wear volume.

Calculating the cable carrier length

Cable carrier length L_k

$$L_k \approx \frac{L_s}{2} + L_B$$

Cable carrier length L_k rounded to pitch t

h_i [mm]	h_G [mm]	h_G' [mm]	h_G' Offroad [mm]	B_i [mm]*	B_k [mm]	B_{EF} [mm]	KR [mm]				q_k [kg/m]
54	80	83.5	86	75 – 600	$B_i + 39$	$B_i + 39$	140	170	200	260	3.63 – 6.55
							290	320	380		

* in 1 mm width sections

Order example



MC0950

Type

400

B_i [mm]

RM

Stay variant

200

KR [mm]

2850

L_k [mm]

HS

Stay arrangement

Aluminum stay LG – Hole stay, split version

- Optimum cable routing in the neutral bending line. Split version for easy cable routing. Stays also available unsplit.
- Available customized in **1 mm width sections**.
- **Outside/inside:** Screw-fixing easy to release.



Stay arrangement on every 2nd chain link, **standard** (HS: half-stayed)



Stay arrangement on each chain link (**VS: fully-stayed**)



1 mm B_i 75 – 600 mm in **1 mm width sections**

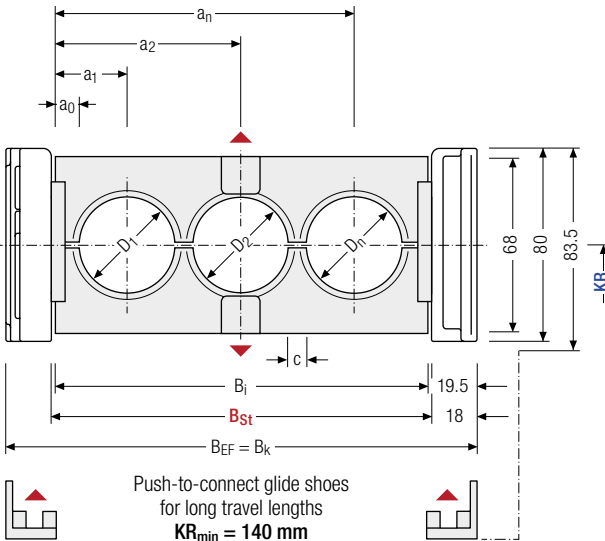

The maximum cable diameter strongly depends on the bending radius and the desired cable type. Please contact us.

Calculating the cable carrier length

Cable carrier length L_k

$$L_k \approx \frac{L_s}{2} + L_B$$

Cable carrier length L_k rounded to pitch t

Calculating the stay width

Stay width B_{St}

$$B_{St} = \sum D + \sum c + 2 a_0$$

D _{max} [mm]	D _{min} [mm]	h _G [mm]	B _i [mm]	B _{St} [mm]*	B _k [mm]	B _{EF} [mm]	c _{min} [mm]	a _{0 min} [mm]	KR [mm]	q _k 50%** [kg/m]
50	12	80	75 – 600	78 – 603	B _{St} + 39	B _{St} + 39	4	11	140 170 200 260 290 320 380	3.89 – 8.25

* in 1 mm width sections

** Hole ratio of the hole stay approx. 50 %

Order example



MC0950

Type

400

B_i [mm]

LG

Stay variant

200

KR [mm]

2850

L_k [mm]

HS

Stay arrangement

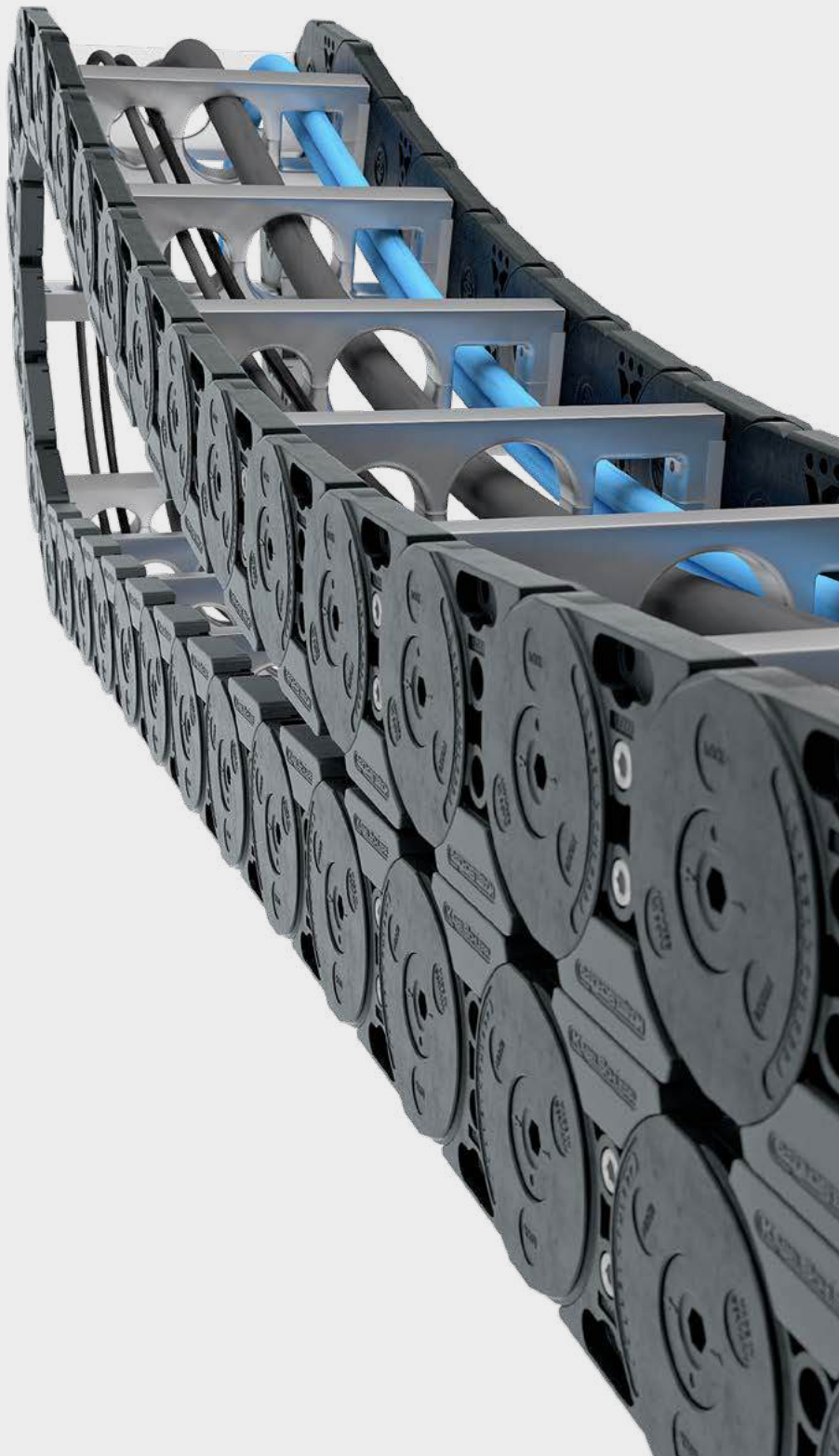

UAT
series

TKA
series

TKR
series

QUANTUM®
series

XL
series

M
series

UNIFLEX
Advanced
series

K
series

PROTUM®
series

Aluminum stay RMA – mounting frame stay

- Aluminum profile bars with plastic mounting frame stays for guiding very large cable diameters.
- The mounting frame stay can be mounted either inside or outside in the bending radius. Available customized in **1 mm width sections**.
- Outside/inside:** Screw-fixing easy to release.

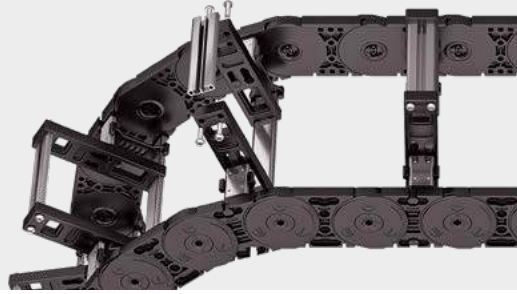

Stay arrangement on every 2nd chain link, **standard** (HS: half-stayed)



Stay arrangement on each chain link (**VS: fully-stayed**)



1 mm B_i 200 – 500 mm in **1 mm width sections**

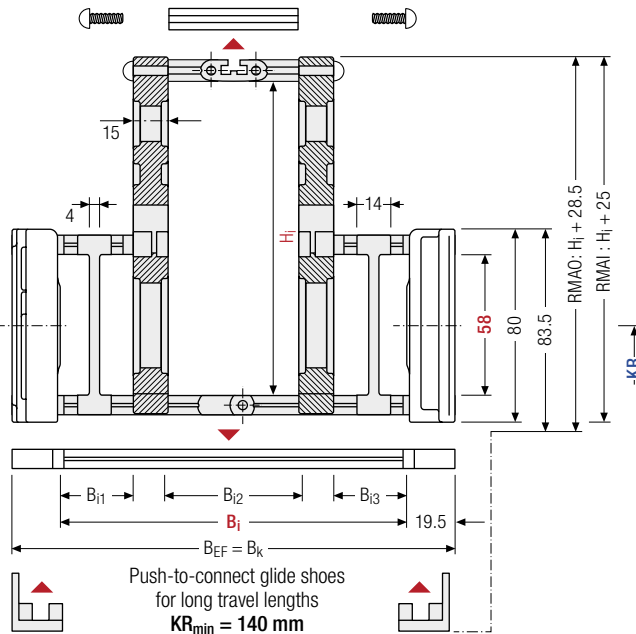

The maximum cable diameter strongly depends on the bending radius and the desired cable type. Please contact us.

Calculating the cable carrier length

Cable carrier length L_k

$$L_k \approx \frac{L_s}{2} + L_B$$

Cable carrier length L_k rounded to pitch t



Intrinsic cable carrier weight

Determining the intrinsic cable carrier weight strongly depends on the selected stay arrangement. Please contact us.

h_i [mm]	H_i [mm]	h_G [mm]	B_i [mm]	$B_{i1 \text{ min}}$ [mm]	$B_{i3 \text{ min}}$ [mm]	B_k [mm]	B_{EF} [mm]	KR [mm]			
58	130 160	80	200 – 500	40	40	$B_i + 39$	$B_i + 39$	140 290	170 320	200 380	260

Order example



MC0950

Type

400

B_i [mm]

RMAO

Stay variant

200

KR [mm]

2850

L_k [mm]

HS

Stay arrangement

Assembly variants

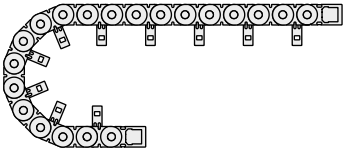

RMAI – assembly to the inside:
 Gliding application is not possible when using assembly version RMAI.

Observe minimum KR:
 H_i = 130 mm: KR_{min} = 170 mm
 H_i = 160 mm: KR_{min} = 200 mm
 H_i = 200 mm: KR_{min} = 260 mm

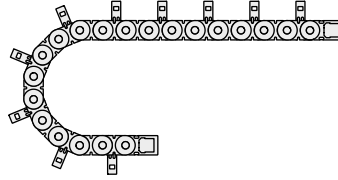

RMAI – assembly to the outside:
 The cable carrier has to rest on the side bands and not on the stays.

Guiding in a **channel is required** for support.
 Please contact our technical support at technik@kabelschlepp.de to find the corresponding guide channel.
 Please note the operating and installation height.

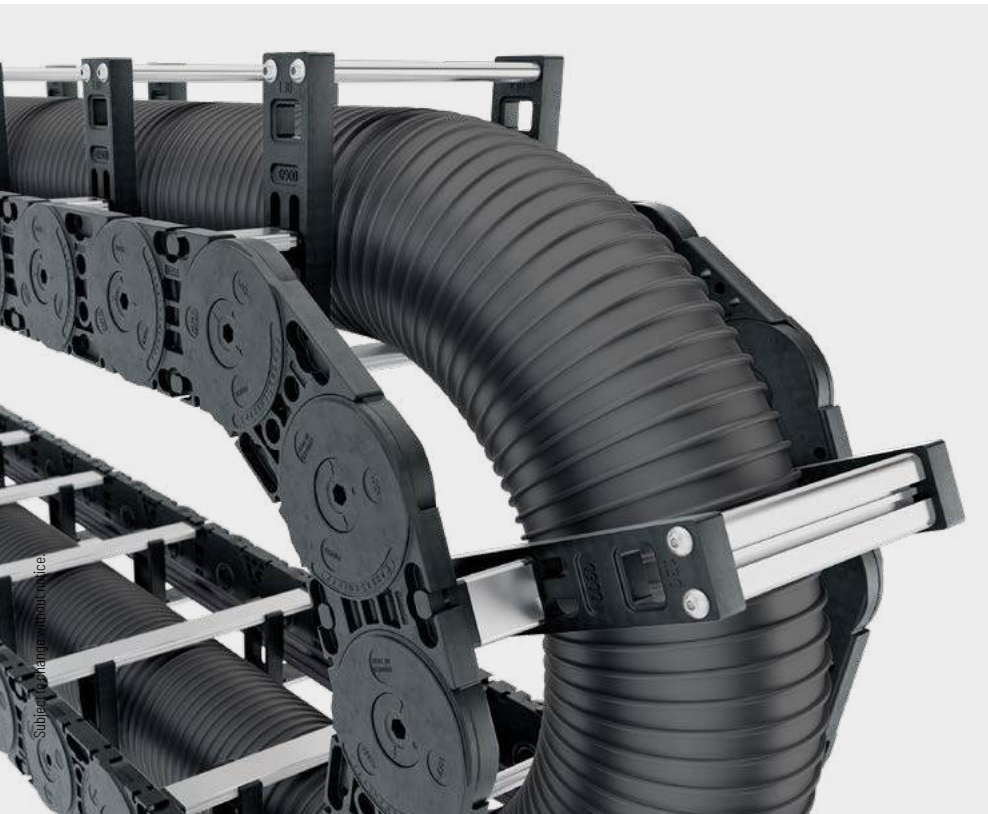

Subject to change without notice

PROTUM® series
K series
UNIFLEX Advanced series
M series
XL series
QUANTUM® series
TKR series
TKA series
UAT series

Aluminum stay RMR – Frame rolling stay

- Aluminum profile bars with rotating plastic rolling stay for highest requirements with gentle cable guiding. Double threaded joint on both sides.
- Available customized in **1 mm grid**.
- **Inside/outside:** Threaded joint easy to release.

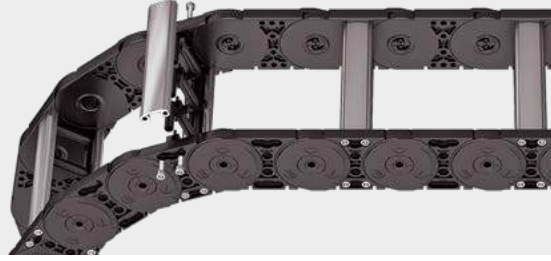

Stay arrangement on every 2nd chain link, **standard (HS: half-stayed)**



Stay arrangement on each chain link (**VS: fully-stayed**)



1 mm B_i 75 – 600 mm in 1 mm width sections

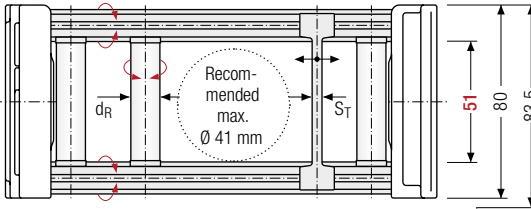

Calculating the cable carrier length

Cable carrier length L_k

$$L_k \approx \frac{L_s}{2} + L_B$$

Cable carrier length L_k rounded to pitch t

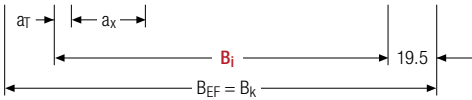

Push-to-connect glide shoes for long travel lengths
 $KR_{min} = 140$ mm

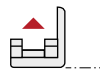

The maximum cable diameter strongly depends on the bending radius and the desired cable type. Please contact us.



For rough environmental conditions, we recommend the use of OFFROAD glide shoes with 80 % higher wear volume.

h_i [mm]	h_G [mm]	h_G' [mm]	h_G' Offroad [mm]	B_i [mm]*	B_k [mm]	B_{EF} [mm]	d_R [mm]	S_T [mm]	a_T min [mm]	a_x min [mm]	KR [mm]	q_k [kg/m]
51	80	83.5	86	75 – 600	$B_i + 39$	$B_i + 39$	10	4	6.5	37	140 170 200 260 290 320 380	3.63 – 6.55

* in 1 mm width sections

Order example



MC0950
Type

400
 B_i [mm]

RMR
Stay variant

200
 KR [mm]

2850
 L_k [mm]

HS
Stay arrangement



Subject to change without notice.

PROTUM®
series

K
series

UNIFLEX
Advanced
series

M
series

XL
series

QUANTUM®
series

TKR
series

TKA
series

UAT
series

Plastic stay RE – screw-in frame stay

- Plastic profile bars for light to medium loads.
Assembly without screws.
- Available customized in **16 mm grid**.
- **Outside/inside:** release by turning by 90°.

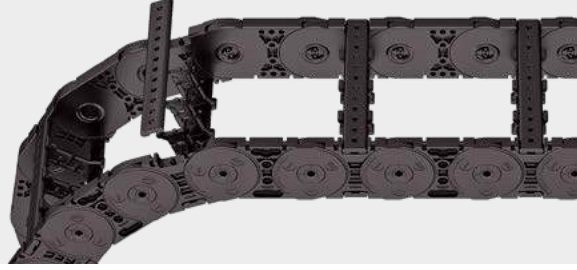

Stay arrangement on every
2nd chain link, **standard**
(HS: half-stayed)



Stay arrangement on each
chain link (VS: fully-stayed)



16 mm B_i 45 – 557 mm
in **16 mm** width sections

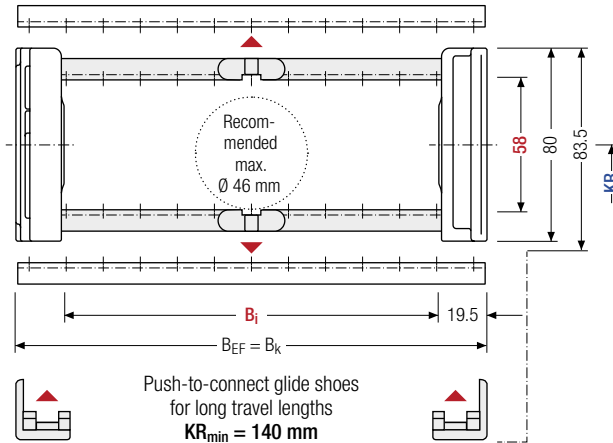

The maximum cable diameter strongly depends on the bending radius and the desired cable type. Please contact us.

For rough environmental conditions, we recommend the use of OFFROAD glide shoes with 80 % higher wear volume.

Calculating the cable carrier length

Cable carrier length L_k

$$L_k \approx \frac{L_s}{2} + L_B$$

Cable carrier length L_k
rounded to pitch t

h _i [mm]	h _G [mm]	h _{G'} [mm]	h _{G'} Offroad [mm]	B _i [mm]				B _k [mm]	B _{EF} [mm]	KR [mm]	q _k [kg/m]					
58	80	83.5	86	45	61	77	93	109	125	141	B _i + 39	B _i + 39	140	170	3.0	
				157	173	189	205	221	237	253			200	260		
				269	285	301	317	333	349	365			290	320		–
				381	397	413	429	445	461	477			380	–		6.2
				493	509	525	541	557	–	–			–	–		–

Order example



ME0950

Type

413

B_i [mm]

RE

Stay variant

200

KR [mm]

2850

L_k [mm]

HS

Stay arrangement

Plastic stay RD – Frame stay with hinge

- Plastic profile bars with hinge for light to medium loads. Assembly without screws.
- Available customized in **16 mm grid**.
- **Outside:** swivable to both sides.
- **Inside:** release by turning by 90°.



 Stay arrangement on every 2nd chain link, **standard** (HS: half-stayed)

 Stay arrangement on each chain link (**VS: fully-stayed**)

 **16 mm** B_i 45 – 557 mm in **16 mm width sections**

PROTUM® series

K series

UNIFLEX Advanced series

M series

XL series

QUANTUM® series

TKR series

TKA series

UAT series

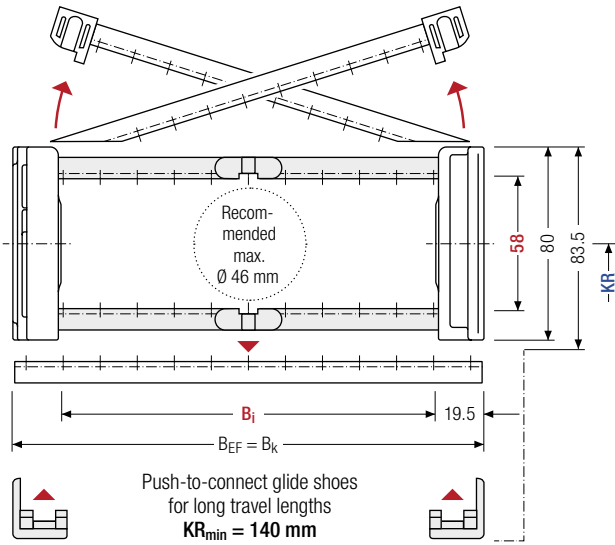

 The maximum cable diameter strongly depends on the bending radius and the desired cable type. Please contact us.

 For rough environmental conditions, we recommend the use of OFFROAD glide shoes with 80 % higher wear volume.

Calculating the cable carrier length

Cable carrier length L_k

$$L_k \approx \frac{L_s}{2} + L_B$$

Cable carrier length L_k rounded to pitch t

h _i [mm]	h _G [mm]	h _{G'} [mm]	h _{G'} Offroad [mm]	B _i [mm]						B _k [mm]	B _{EF} [mm]	KR [mm]	q _k [kg/m]			
58	80	83.5	86	45	61	77	93	109	125	141	B _i + 39	B _i + 39	140	170	3.0	
				157	173	189	205	221	237	253			200	260		
				269	285	301	317	333	349	365			290	320		6.2
				381	397	413	429	445	461	477			380			
				493	509	525	541	557								

Order example

MK0950 Type ·
 413 B_i [mm] ·
 RD Stay variant ·
 200 KR [mm] ·
 2850 L_k [mm] ·
 HS Stay arrangement

Divider systems

As a standard, the divider system is mounted on each crossbar – for stay mounting on every 2nd chain link (HS).

As a standard, dividers and the complete divider system (dividers with height separations) can be moved in the cross section (**version A**).

The dividers are easily attached to the stay for applications with lateral acceleration and for applications laying on their side by simply turning the frame stay by 180°.

The arresting cams click into place in the locking grids in the crossbars (**version B**).
The groove in the frame stay faces outwards.

Divider system TS0 without height separation

Vers.	a_T min [mm]	a_x min [mm]	a_c min [mm]	a_x grid [mm]	n_T min
A	5.5	14.5	8.5	–	–
B	6.5	16	10	16	–

The dividers can be moved within the cross section (version A) or fixed (version B).

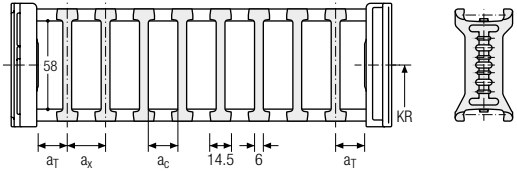

Divider system TS1 with continuous height separation

Vers.	a_T min [mm]	a_T max [mm]	a_x min [mm]	a_c min [mm]	a_x grid [mm]	n_T min
A	5.5	25	14.5	8.5	–	2
B	6.5	25	16	10	16	2

The dividers can be moved within the cross section (version A) or fixed (version B).

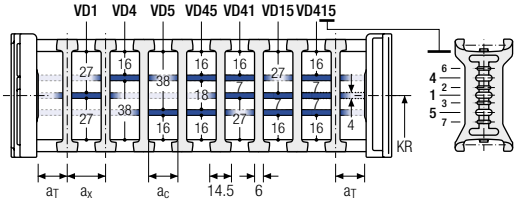

Divider system TS2 with partial height separation

Vers.	a_T min [mm]	a_x min [mm]	a_c min [mm]	a_x grid [mm]	n_T min
A	5.5	14.5/21	8.5/15	–	2
B	6.5	16/32	10/26	16	2

* for VR0

With grid distribution (16 mm grid). The dividers are attached by the height separation, the grid can be moved in the cross section (version A) or fixed (version B).

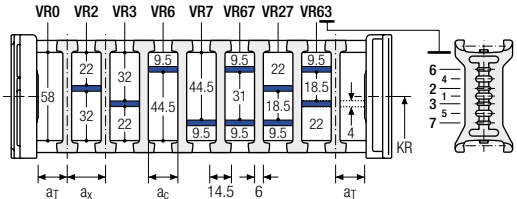

More product information online



Assembly instructions etc.:
Additional info via your
smartphone or check online at
[tsubaki-kabelschlepp.com/
downloads](http://tsubaki-kabelschlepp.com/downloads)



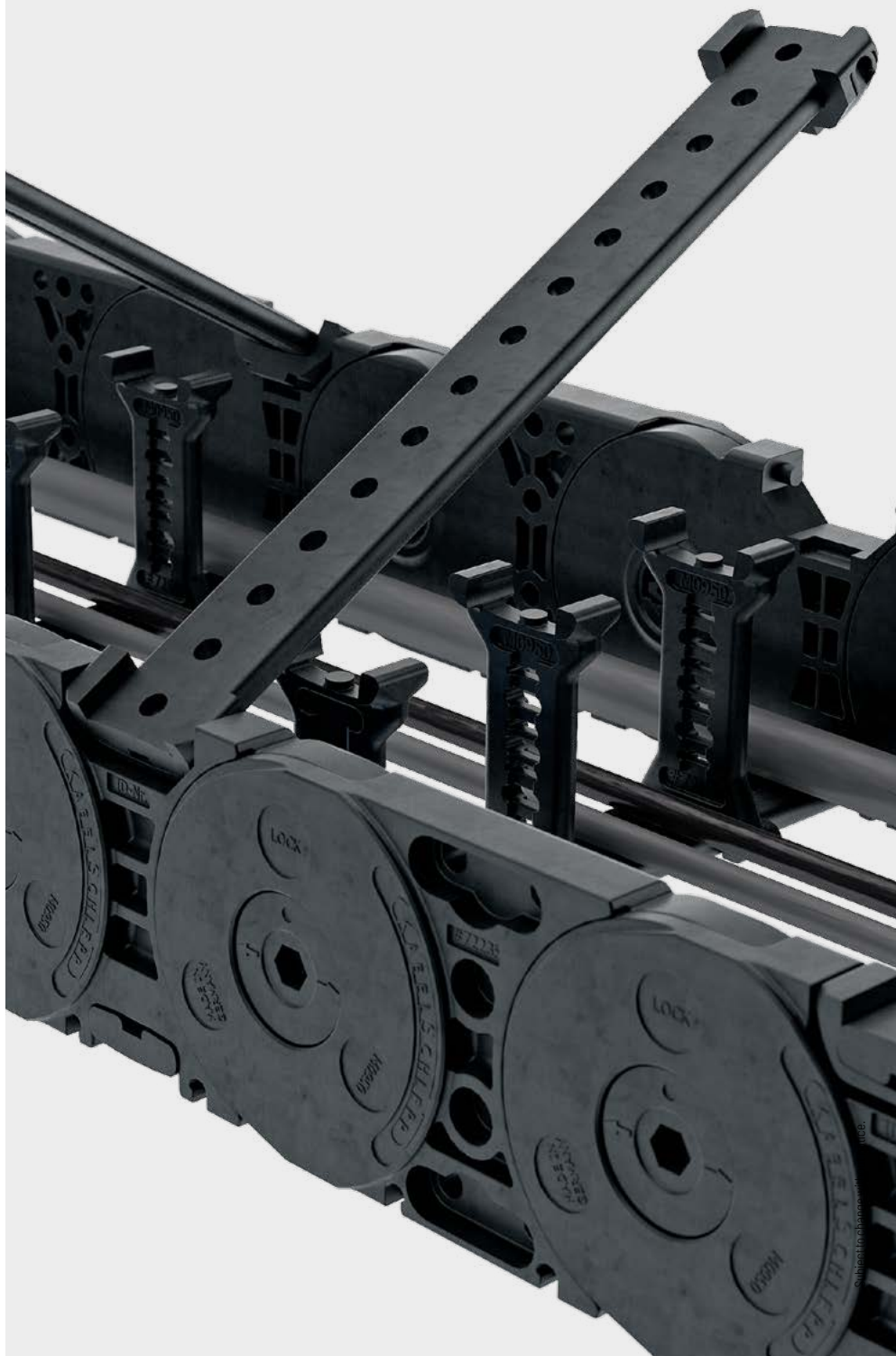

Configure your custom
cable carrier here:
online-engineer.de

PROTUM®
seriesK
seriesUNIFLEX
Advanced
seriesM
seriesXL
seriesQUANTUM®
seriesTKR
seriesTKA
seriesUAT
series

Universal end connectors UMB – plastic (standard)

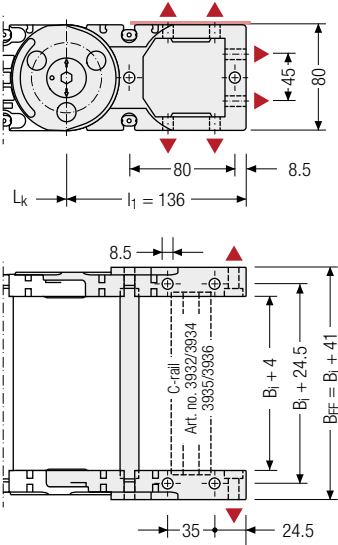
The universal mounting brackets (UMB) are made from plastic and can be mounted **from the top, from the bottom, face on or from the side.**



 Recommended tightening torque: 27 Nm for cheese-head screws ISO 4762 - M8 - 8.8

End connectors – plastic/steel

Plastic link end connector, steel end connector. The connection variants on the fixed point and on the driver can be combined and, if required, changed afterwards.

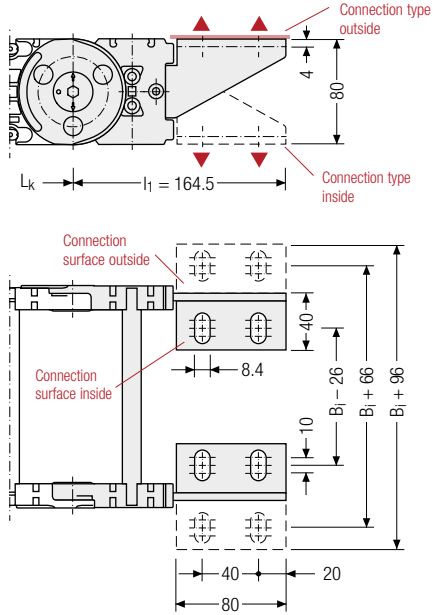

 Assembly options

Connection point

- F – fixed point
- M – driver

Connection type

- U – universal mounting bracket

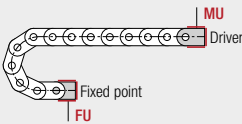

Connection point

- F – fixed point
- M – driver

Connection surface

- I – connection surface inside
- A – connection surface outside

Connection type

- A – threaded joint outside (standard)
- I – threaded joint inside
- F – flange connection

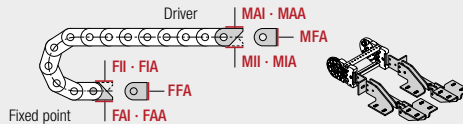

Order example

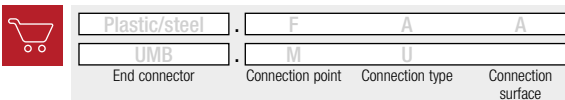

 We recommend the use of strain reliefs at the driver and fixed point. See from p. 904.

PROTUM® series
K series
UNIFLEX Advanced series
M series
XL series
QUANTUM® series
TKR series
TKA series
UAT series

M1250



Pitch
125 mm



Inner heights
66 – 76 mm



Inner widths
71 – 800 mm

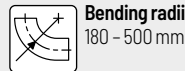

Bending radii
180 – 500 mm

Stay variants



Aluminum stay RS page 418

Frame stay, narrow "The standard"

- » Aluminum profile bars for light to medium loads. Assembly without screws.
- » **Outside/inside:** release by turning by 90°.



Aluminum stay RV page 422

Frame stay, reinforced

- » Aluminum profile bars with plastic adapter for medium to high loads and large cable carrier widths. Assembly without screws.
- » **Outside/inside:** release by turning by 90°.



Aluminum stay RM page 426

Frame stay, solid

- » Aluminum profile bars for heavy loads and maximum cable carrier widths. Double threaded joints on both sides "Heavy Duty".
- » **Inside/outside:** Threaded joint easy to release.



Aluminum stay LG page 428

Hole stay, split version

- » Optimum cable routing in the neutral bending line. Split version for easy cable routing. Stays also available unsplit.
- » **Outside/inside:** Screw-fixing easy to release.

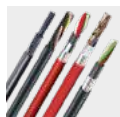

TRAXLINE® cables for cable carriers

Hi-flex electric cables which were specially developed, optimised and tested for use in cable carriers can be found at tsubaki-kabelschlepp.com/traxline.

Stay variants

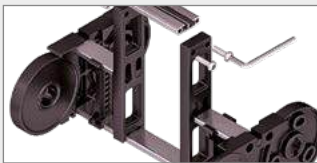

Aluminum stay RMA page 430

Mounting frame stay

- » Aluminum profile bars with plastic mounting frame stays for guiding very large cable diameters.
- » **Outside/inside:** Screw-fixing easy to release.



Aluminum stay RMR page 432

Frame rolling stay

- » Aluminum profile bars with rotating plastic rolling stay for highest requirements with gentle cable guiding. Double threaded joint on both sides.
- » **Inside/outside:** threaded joint easy to release.



Plastic stay RE page 434

Frame screw-in stay

- » Plastic profile bars for light to medium loads. Assembly without screws.
- » **Outside/inside:** release by turning by 90°.



Plastic stay RD page 435

Frame stay with hinge

- » Plastic profile bars with hinge for light to medium loads. Assembly without screws.
- » **Outside:** swivable to both sides.
- » **Inside:** release by turning by 90°.

Serie MT

Also available as covered variants with cover system.
More information can be found in
chapter "MT series" from p. 612.



PROTUM®
series

K
series

UNIFLEX
Advanced
series

M
series

XL
series

QUANTUM®
series

TKR
series

TKA
series

UAT
series

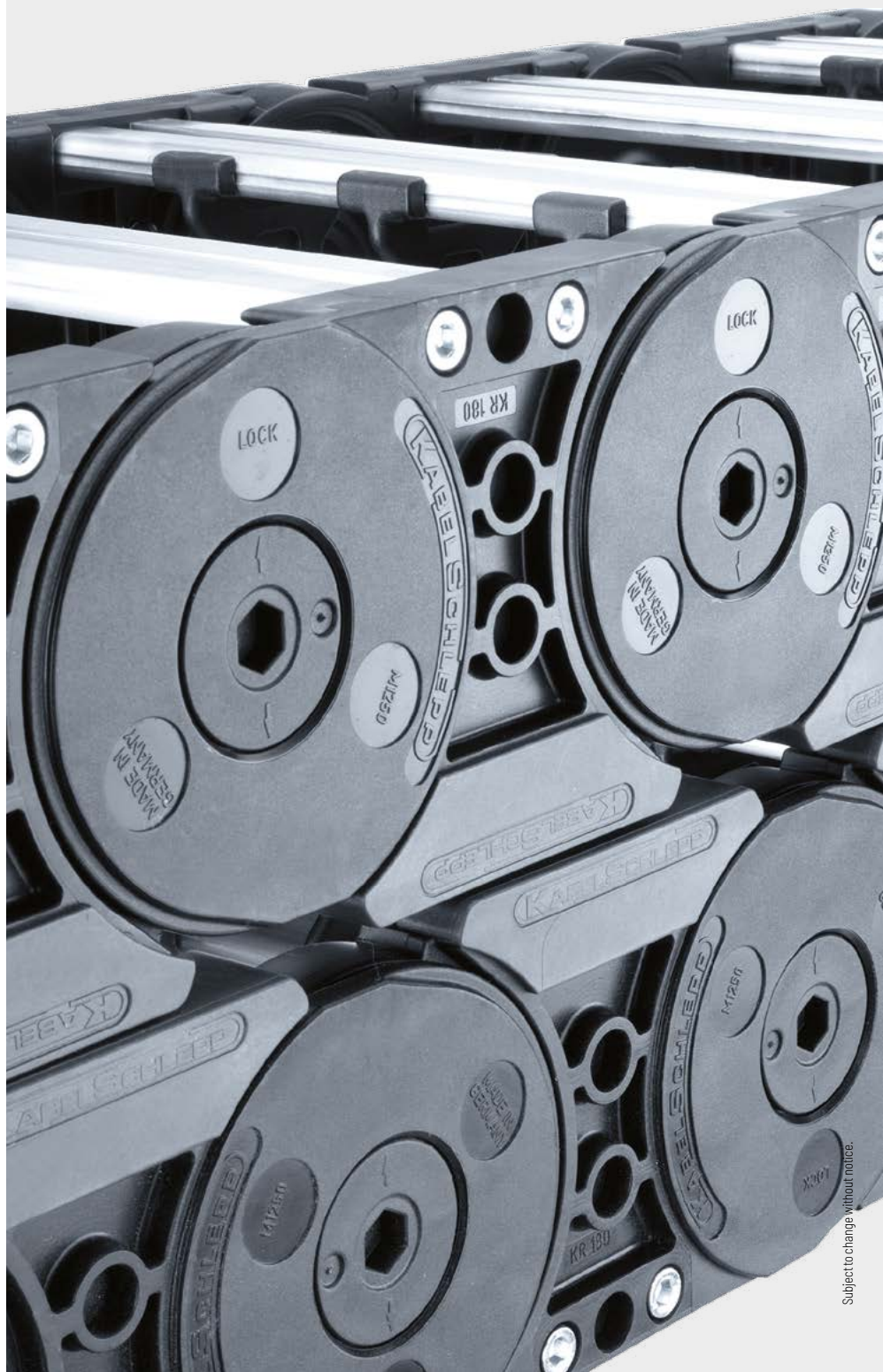

Unsupported arrangement

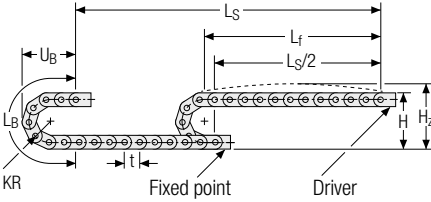

KR [mm]	H [mm]	H ₂ [mm]	L _B [mm]	U _B [mm]
180	456	506	816	353
220	536	586	942	393
260	616	666	1067	433
300	696	746	1193	473
340	776	826	1319	513
380	856	906	1444	553
500	1096	1146	1821	673

Load diagram for unsupported length depending on the additional load.

Sagging of the cable carrier is technically permitted for extended travel lengths, depending on the specific application.

Intrinsic cable carrier weight $q_k = 4.5 \text{ kg/m}$. For other inner widths, the maximum additional load changes.

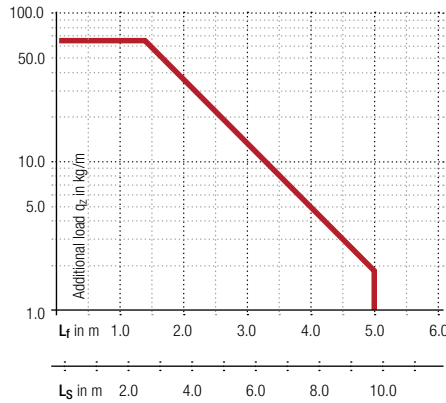

Speed
up to 10 m/s

Acceleration
up to 25 m/s²

Travel length
up to 9.7 m

Additional load
up to 65 kg/m

Gliding arrangement | GO module with chain links optimized for gliding

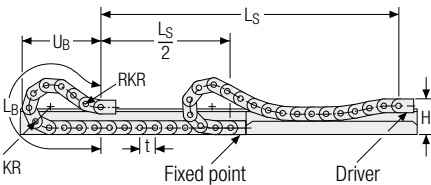

KR [mm]	H [mm]	GO module RKR [mm]	L _B [mm]	U _B [mm]
180	288	500	2000	930
220	288	500	2250	1015
260	288	500	2500	1095
300	288	500	2750	1177
340	288	500	3125	1318
380	288	500	3375	1403
500	288	500	4375	1770

Speed
up to 8 m/s

Acceleration
up to 20 m/s²

Travel length
up to 320 m

Additional load
up to 65 kg/m

The gliding cable carrier must be guided in a channel. See p. 844.

The GO module mounted on the driver is a defined sequence of 4 adapted KR/RKR link plates.

Glide shoes have to be used for gliding applications.

PROTUM® series
K series
UNIFLEX Advanced series
M series
XL series
QUANTUM® series
TKR series
TKA series
UAT series

Aluminum stay RS – frame stay narrow

- Extremely quick to open and close
- Aluminum profile bars for light to medium loads.
Assembly without screws.
- Available customized in **1 mm grid**.
- Outside/inside:** release by turning by 90°.



Stay arrangement on every 2nd chain link, **standard** (HS: half-stayed)



Stay arrangement on each chain link (**VS: fully-stayed**)



1 mm B_i 75 – 400 mm
in **1 mm width sections**

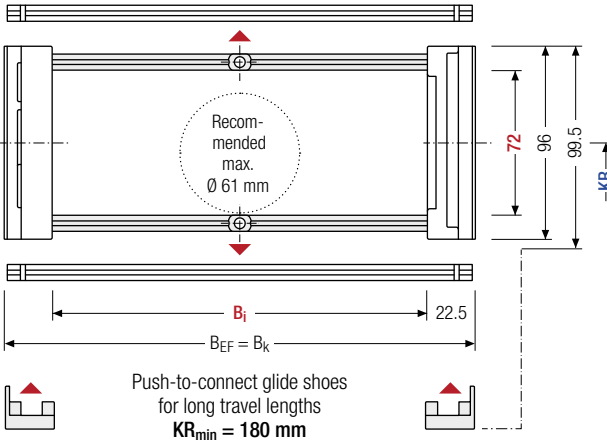

The maximum cable diameter strongly depends on the bending radius and the desired cable type. Please contact us.

For rough environmental conditions, we recommend the use of OFFROAD glide shoes with 80 % higher wear volume.

Calculating the cable carrier length

Cable carrier length L_k

$$L_k \approx \frac{L_s}{2} + L_B$$

Cable carrier length L_k rounded to pitch t

h_i [mm]	h_G [mm]	h_G^* [mm]	h_G^* Offroad [mm]	B_i [mm]*	B_k [mm]	B_{EF} [mm]	KR [mm]		q_k [kg/m]
72	96	99.5	103	75 – 400	$B_i + 45$	$B_i + 45$	180	220	4.10 – 4.97
							340	380	
								500	

* in 1 mm width sections

Order example



MC1250

Type

400

B_i [mm]

RS

Stay variant

300

KR [mm]

4250

L_k [mm]

HS

Stay arrangement

Divider systems

As a standard, the divider system is mounted on each crossbar – for stay mounting on every 2nd chain link (HS).
As a standard, dividers and the complete divider system (dividers with height separations) can be moved in the cross section (**version A**).

For applications with lateral acceleration and rotated by 90°, the dividers can be attached by simply clipping on a socket (available as an accessory).
The bushing additionally serves as a spacer between the dividers and is available in 1 mm sections between 3 – 50 mm (**version B**).

Divider system TSO without height separation

Vers.	a _T min [mm]	a _x min [mm]	a _c min [mm]	n _T min
A	7.5	15	10	2

The dividers can be moved in the cross section.

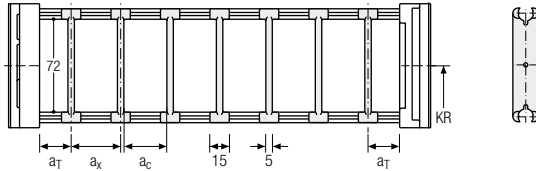

Divider system TS1 with continuous height separation

Vers.	a _T min [mm]	a _T max [mm]	a _x min [mm]	a _c min [mm]	n _T min
A	7.5	25	15	10	2

The dividers can be moved in the cross section.

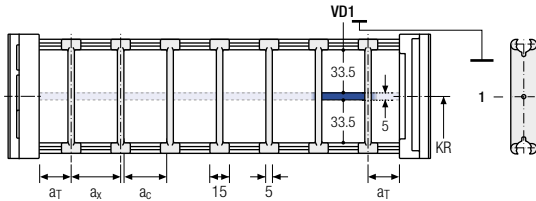

PROTUM® series
K series
UNIFLEX Advanced series
M series
XL series
QUANTUM® series
TKR series
TKA series
UAT series



TOTALTRAX® complete systems

Benefit from the advantages of the TOTALTRAX® complete system. A complete delivery from one source – with a warranty certificate on request! Learn more at tsubaki-kabelschlepp.com/totaltrax



TRAXLINE® cables for cable carriers

Hi-flex electric cables which were especially developed, optimized and tested for use in cable carriers can be found at tsubaki-kabelschlepp.com/traxline

Divider system TS3 with height separation consisting of plastic partitions

As a standard, the divider **version A** is used for vertical partitioning within the cable carrier. The complete divider system can be moved within the cross section.

PROTUM® series

K series

Divider version A

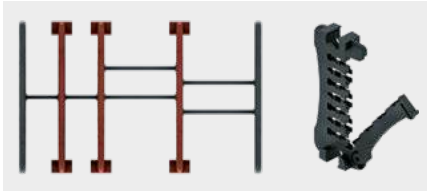

End divider

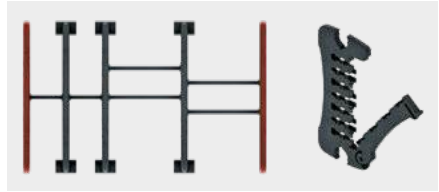

UNIFLEX Advanced series

M series

Vers.	a _T min [mm]	a _x min [mm]	a _c min [mm]	n _T min
A	6/2*	14	10	2

* For End divider

The dividers are fixed by the partitions, the complete divider system is movable in the cross section.

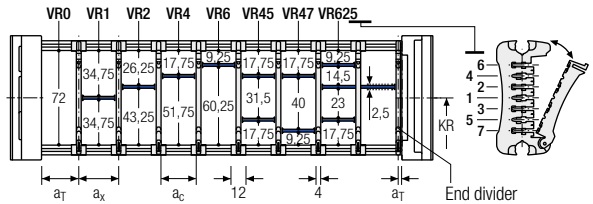

XL series

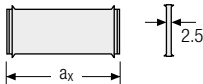

a _x (center distance of dividers) [mm]																
a _c (nominal width of inner chamber) [mm]																
14	16	19	23	24	28	29	32	33	34	38	39	43	44	48	49	54
10	12	15	19	20	24	25	28	29	30	34	35	39	40	44	45	50
58	59	64	68	69	74	78	79	80	84	88	89	94	96	99	112	
54	55	60	64	65	70	74	75	76	80	84	85	90	92	95	108	

When using partitions with a_x > 49 mm we recommended an additional preferential central support.

QUANTUM® series

TKR series

Order example

TS3 .
 A .
 3 .
 K1 .
 34 -
 VR1
 ⋮ ⋮ ⋮
K4 .
 38 -
 VR3

Divider system
Version
n_T
Chamber
a_x
Height separation

TKA series

Please state the designation of the divider system (TS0, TS1,...), version and number of dividers per cross section [n_T]. In addition, please also enter the chambers [K] from left to right, as well as the assembly distances [a_T/a_x] (as seen from the driver).

If using divider systems with height separation (TS1, TS3) please also state the positions [e.g. VD23] viewed from the left driver belt. You are welcome to add a sketch to your order.

UAT series

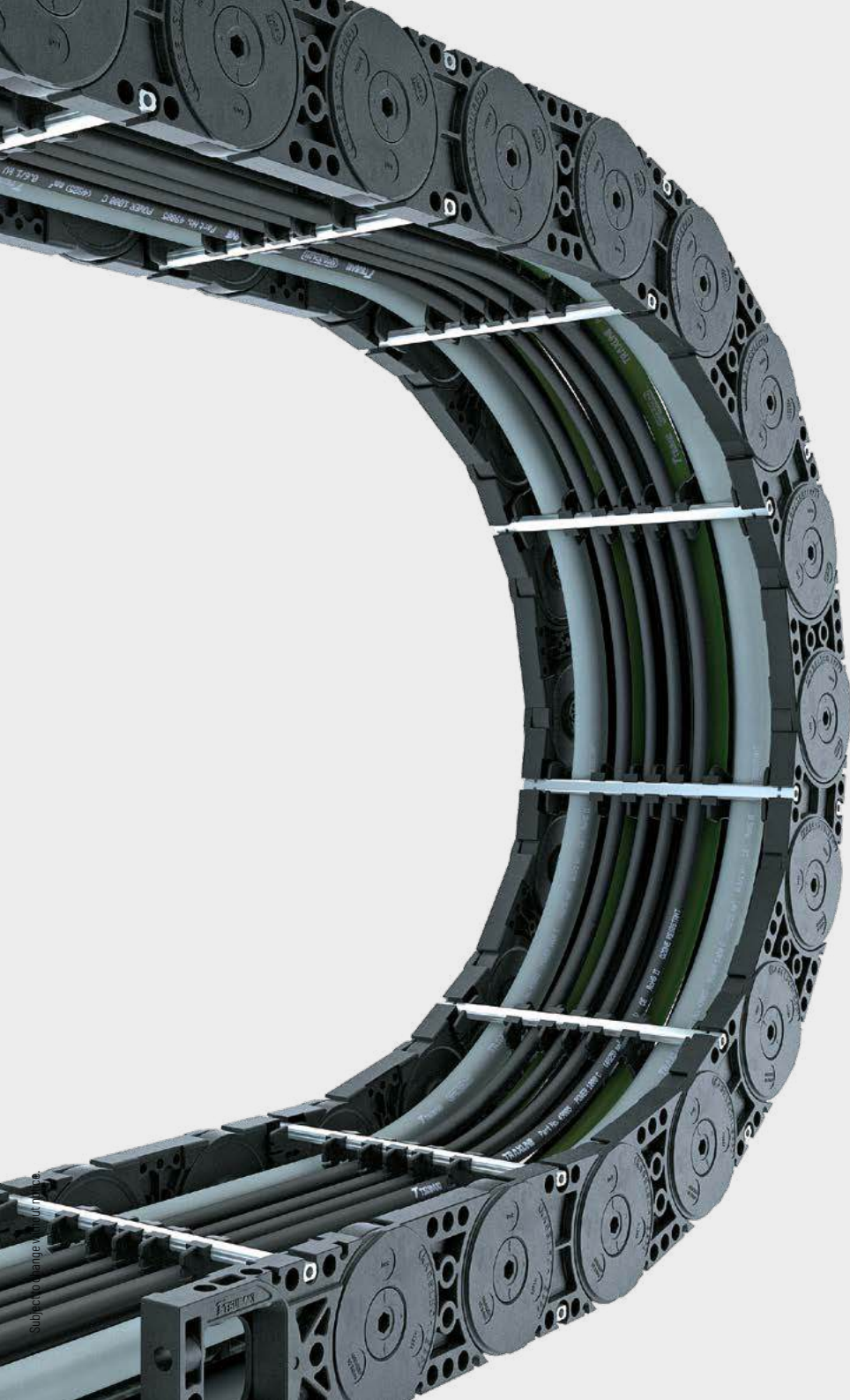

Subject to change without notice.

PROTUM®
series

K
series

UNIFLEX
Advanced
series

M
series

XL
series

QUANTUM®
series

TKR
series

TKA
series

UAT
series

Aluminum stay RV – frame stay reinforced

- Aluminum profile bars with plastic adapter for medium to high loads and large cable carrier widths. Assembly without screws.
- Available customized in **1 mm grid**.
- **Outside/inside:** release by turning by 90°.



Stay arrangement on every 2nd chain link, **standard** (HS: half-stayed)



Stay arrangement on each chain link (**VS: fully-stayed**)



1 mm B_i 100 – 600 mm in **1 mm width sections**

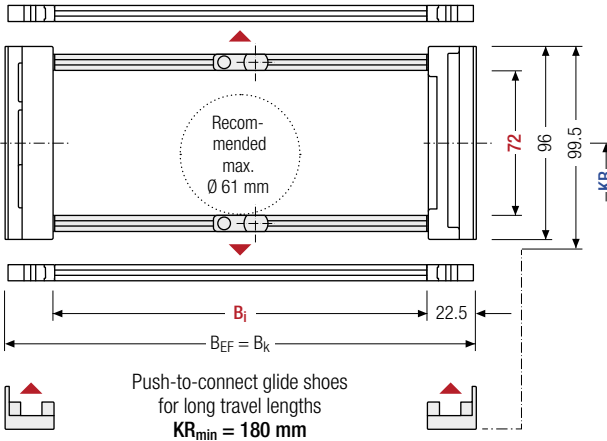

The maximum cable diameter strongly depends on the bending radius and the desired cable type. Please contact us.

For rough environmental conditions, we recommend the use of OFFROAD glide shoes with 80 % higher wear volume.

Calculating the cable carrier length

Cable carrier length L_k

$$L_k \approx \frac{L_s}{2} + L_B$$

Cable carrier length L_k rounded to pitch t

h _i [mm]	h _G [mm]	h _{G'} [mm]	h _{G'} Offroad [mm]	B _i [mm]*	B _k [mm]	B _{EF} [mm]	KR [mm]		q _k [kg/m]			
72	96	99.5	103	100 – 600	B _i + 45	B _i + 45	180	220	260	300	4.40 – 6.18	
							340	380	500			

* in 1 mm width sections

Order example



MC1250

Type

400

B_i [mm]

RV

Stay variant

300

KR [mm]

4250

L_k [mm]

HS

Stay arrangement

Divider systems

As a standard, the divider system is mounted on each crossbar – for stay mounting on every 2nd chain link (HS).

As a standard, dividers and the complete divider system (dividers with height separations) can be moved in the cross section (**version A**).

Divider system TSO without height separation

Vers.	a _T min [mm]	a _x min [mm]	a _c min [mm]	n _T min
A	8	16	10	2

The dividers can be moved in the cross section.

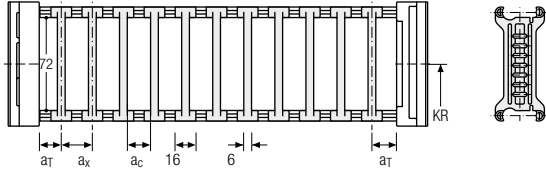

Divider system TS1 with continuous height separation

Vers.	a _T min [mm]	a _T max [mm]	a _x min [mm]	a _c min [mm]	n _T min
A	8	25	16	10	2

The dividers can be moved in the cross section.

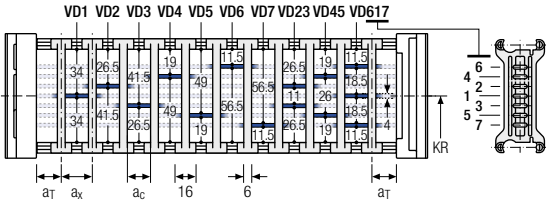

Divider system TS2 with partial height separation

Vers.	a _T min [mm]	a _x min [mm]	a _c min [mm]	n _T min
A	8	21	15	2

With grid distribution (1 mm grid). The dividers are attached by the height separation, the grid can be moved in the cross section.

Sliding dividers are optionally available (thickness of divider = 6 mm).

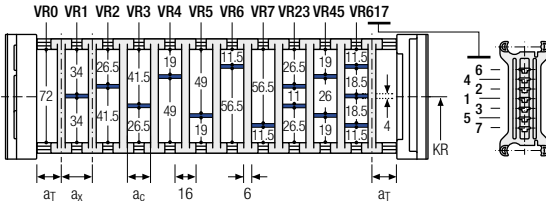

PROTUM® series
K series
UNIFLEX Advanced series
M series
XL series
QUANTUM® series
TKR series
TKA series
UAT series

TOTALTRAX® complete systems

Benefit from the advantages of the TOTALTRAX® complete system. A complete delivery from one source – with a warranty certificate on request! Learn more at tsubaki-kabelschlepp.com/totaltrax

TRAXLINE® cables for cable carriers

Hi-flex electric cables which were especially developed, optimized and tested for use in cable carriers can be found at tsubaki-kabelschlepp.com/traxline

Divider system TS3 with height separation made of plastic partitions

Vers.	a_T min [mm]	a_x min [mm]	a_c min [mm]	n_T min
A	4	16/42*	8	2

* For aluminum partitions

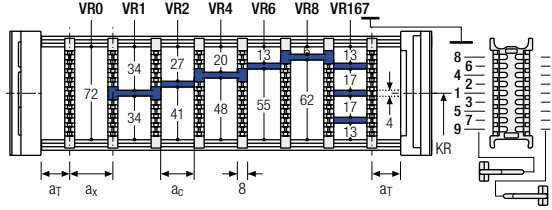

The dividers are fixed by the partitions, the complete divider system is movable in the cross section.

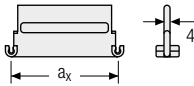

Aluminum partitions in 1 mm increments with $a_x > 42$ mm are also available.

a_x (center distance of dividers) [mm]											
a_c (nominal width of inner chamber) [mm]											
16	18	23	28	32	33	38	43	48	58	64	68
8	10	15	20	24	25	30	35	40	50	56	60
78	80	88	96	112	128	144	160	176	192	208	
70	72	80	88	104	120	136	152	168	184	200	

When using **plastic partitions with $a_x > 112$ mm**, we recommend an additional center support with a **twin divider** ($S_T = 4$ mm). Twin dividers are also suitable for retrofitting in the partition system.

Order example

	<input type="text" value="TS3"/>	.	<input type="text" value="A"/>	.	<input type="text" value="3"/>	.	<input type="text" value="K1"/>	.	<input type="text" value="34"/>	-	<input type="text" value="VR1"/>
							⋮		⋮		⋮
							<input type="text" value="K4"/>	.	<input type="text" value="38"/>	-	<input type="text" value="VR3"/>
	Divider system		Version		n_T		Chamber		a_x		Height separation

Please state the designation of the divider system (**TS0**, **TS1** ...), version and number of dividers per cross section [n_T]. In addition, please also enter the chambers [K] from left to right, as well as the assembly distances [a_T/a_x] (as seen from the driver).

If using divider systems with height separation (**TS1**, **TS3**) please also state the positions [e.g. VD23] viewed from the left driver belt. You are welcome to add a sketch to your order.

More product information online



Assembly instructions etc.:
Additional info via your
smartphone or check online at
[tsubaki-kabelschlepp.com/
support](http://tsubaki-kabelschlepp.com/support)



Configure your custom
cable carrier here:
online-engineer.de



UAT
series

TKA
series

TKR
series

QUANTUM®
series

XL
series

M
series

UNIFLEX
Advanced
series

K
series

PROTUM®
series

Aluminum stay RM – frame stay solid

- Aluminum profile bars for heavy loads and maximum cable carrier widths. Double threaded joints on both sides “**Heavy Duty**”.
- Available customized in **1 mm grid**.
- **Inside/outside:** Threaded joint easy to release.

HEAVY DUTY
TSUBAKI KABELSCHLEPP

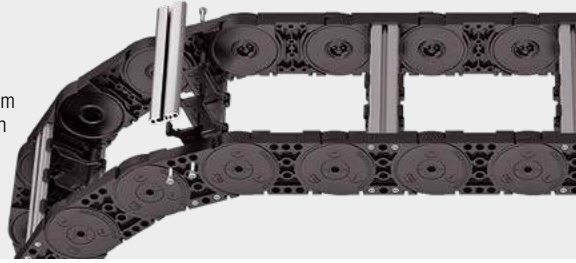

Stay arrangement on every 2nd chain link, **standard** (HS: half-stayed)



Stay arrangement on each chain link (VS: fully-stayed)



1 mm B_i 100 – 800 mm in **1 mm width sections**

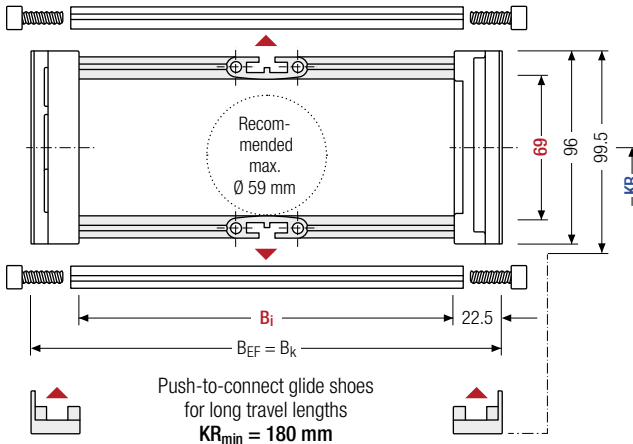

The maximum cable diameter strongly depends on the bending radius and the desired cable type. Please contact us.



For rough environmental conditions, we recommend the use of OFFROAD glide shoes with 80 % higher wear volume.

Calculating the cable carrier length

Cable carrier length L_k

$$L_k \approx \frac{L_s}{2} + L_B$$

Cable carrier length L_k rounded to pitch t

h_i [mm]	h_G [mm]	h_G' [mm]	h_G' Offroad [mm]	B _i [mm]*	B _k [mm]	B _{EF} [mm]	KR [mm]		q _k [kg/m]
69	96	99.5	103	100 – 800	B _i + 45	B _i + 45	180	220	4.14 – 8.48
							340	380	
								500	

* in 1 mm width sections

Order example



MC1250

Type

400

B_i [mm]

RM

Stay variant

300

KR [mm]

4250

L_k [mm]

HS

Stay arrangement

Divider systems

As a standard, the divider system is mounted on each crossbar – for stay mounting on every 2nd chain link (HS).

As a standard, dividers and the complete divider system (dividers with height separations) can be moved in the cross section (**version A**).

Divider system TSO without height separation

Vers.	a _T min [mm]	a _x min [mm]	a _c min [mm]	n _T min
A	10	20	15	–

The dividers can be moved in the cross section.

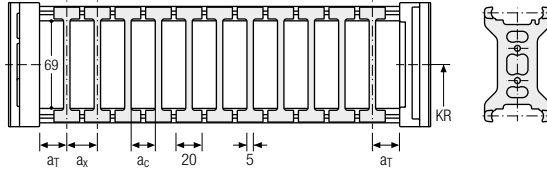

Divider system TS1 with continuous height separation

Vers.	a _T min [mm]	a _T max [mm]	a _x min [mm]	a _c min [mm]	n _T min
A	6	25	12	8	2

The dividers can be moved in the cross section.

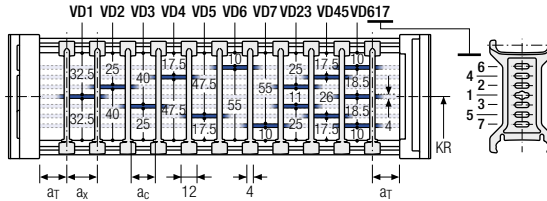

Divider system TS2 with partial height separation

Vers.	a _T min [mm]	a _x min [mm]	a _c min [mm]	n _T min
A	7	21	15	2

With grid distribution (1 mm grid). The dividers are attached by the height separation, the grid can be moved in the cross section.

Sliding dividers are optionally available (thickness of divider = 4 mm).

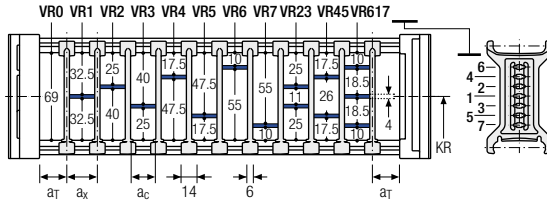

Order example

TS2

A

3

K1

34

VR1

⋮

⋮

⋮

K4

38

VR3

Divider system Version n_T Chamber a_x Height separation

Please state the designation of the divider system (TS0, TS1 ...), version and number of dividers per cross section [n_T]. In addition, please also enter the chambers [K] from left to right, as well as the assembly distances [a_T/a_x] (as seen from the driver).

If using divider systems with height separation (TS1 – TS2) please also state the positions [e.g. VD23] viewed from the left driver belt. You are welcome to add a sketch to your order.

- PROTUM® series
- K series
- UNIFLEX Advanced series
- M series
- XL series
- QUANTUM® series
- TKR series
- TKA series
- UAT series

Aluminum stay LG – Hole stay, split version

- Optimum cable routing in the neutral bending line.
Split version for easy cable routing. Stays also available unsplit.
- Available customized in **1 mm width sections**.
- **Outside/inside:** Screw-fixing easy to release.



Stay arrangement on every 2nd chain link, **standard** (HS: half-stayed)



Stay arrangement on each chain link (VS: fully-stayed)



1 mm B_i 100 – 800 mm in **1 mm width sections**

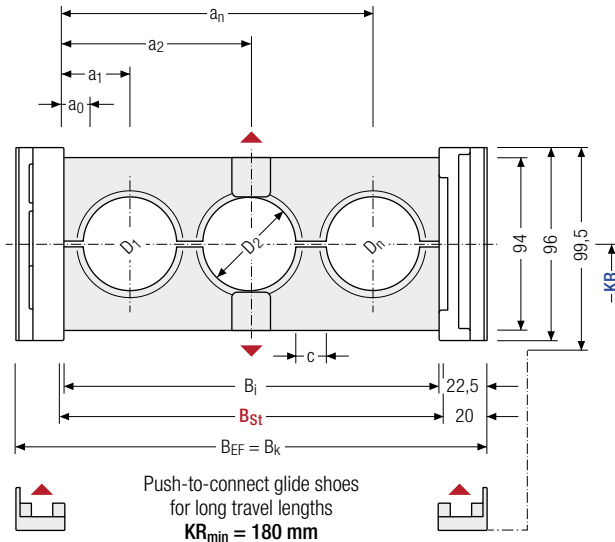

The maximum cable diameter strongly depends on the bending radius and the desired cable type. Please contact us.

Calculating the cable carrier length

Cable carrier length L_k

$$L_k \approx \frac{L_s}{2} + L_B$$

Cable carrier length L_k rounded to pitch t

Calculating the stay width

Stay width B_{St}

$$B_{St} = \sum D + \sum c + 2 a_0$$

D _{max} [mm]	D _{min} [mm]	h _G [mm]	B _i [mm]	B _{St} [mm]*	B _k [mm]	B _{EF} [mm]	c _{min} [mm]	a ₀ min [mm]	KR [mm]	q _k 50 %** [kg/m]
76	12	96	100 – 800	105 – 805	B _{St} + 40	B _{St} + 40	4	12	180 220 260 300 340 380 500	4.75 – 11.17

* in 1 mm width sections

** Hole ratio of the hole stay approx. 50 %

Order example



MC1250

Type

400

B_i [mm]

LG

Stay variant

300

KR [mm]

4250

L_k [mm]

HS

Stay arrangement

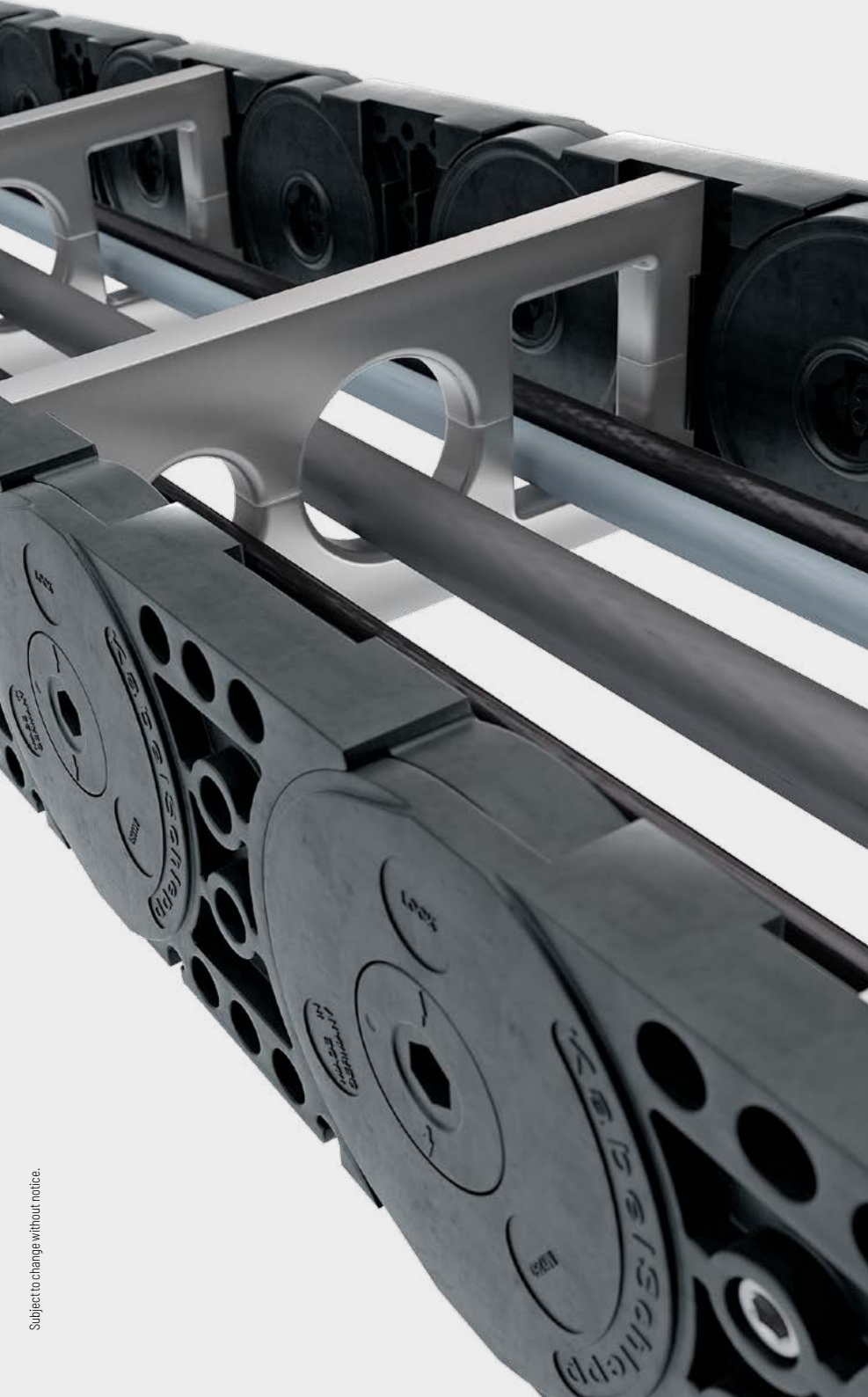

PROTUM®
series

K
series

UNIFLEX
Advanced
series

M
series

XL
series

QUANTUM®
series

TKR
series

TKA
series

UAT
series

Aluminum stay RMA – mounting frame stay

- Aluminum profile bars with plastic mounting frame stays for guiding very large cable diameters.
- The mounting frame stay can be mounted either inside or outside in the bending radius. Available customized in **1 mm width sections**.
- Outside/inside:** Screw-fixing easy to release.



Stay arrangement on every 2nd chain link, **standard** (HS: half-stayed)



Stay arrangement on each chain link (**VS: fully-stayed**)



1 mm B_i 200 – 800 mm in **1 mm width sections**

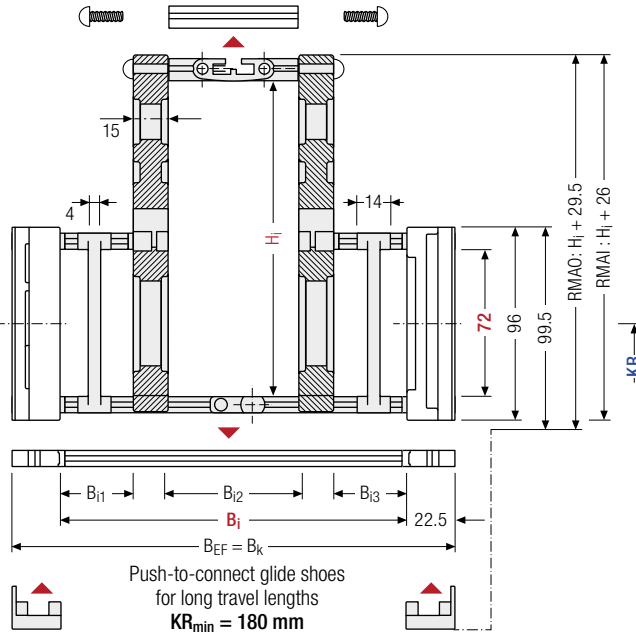

i The maximum cable diameter strongly depends on the bending radius and the desired cable type. Please contact us.

Calculating the cable carrier length

Cable carrier length L_k

$$L_k \approx \frac{L_s}{2} + L_B$$

Cable carrier length L_k rounded to pitch t

i Intrinsic cable carrier weight

Determining the intrinsic cable carrier weight strongly depends on the selected stay arrangement. Please contact us.

h_i [mm]	H_i [mm]	h_G [mm]	B_i [mm]	$B_{i1 \text{ min}}$ [mm]	$B_{i3 \text{ min}}$ [mm]	B_k [mm]	B_{EF} [mm]	KR [mm]			
72	130 160	96	200 – 800	40	40	$B_i + 45$	$B_i + 45$	180	220	260	300
	200							340	380	500	

Order example



MC1250

Type

400

B_i [mm]

RMAO

Stay variant

300

KR [mm]

4250

L_k [mm]

HS

Stay arrangement

Assembly variants

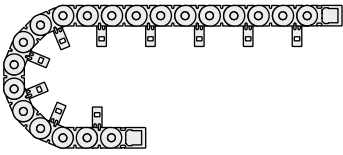

RMAI – assembly to the inside:
 Gliding application is not possible when using assembly version RMAI.

Observe minimum KR:
 H_i = 130 mm: KR_{min} = 180 mm
 H_i = 160 mm: KR_{min} = 180 mm
 H_i = 200 mm: KR_{min} = 220 mm

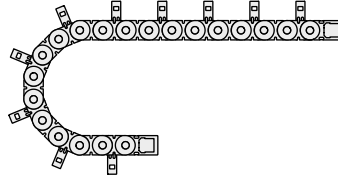

RMAO – assembly to the outside:
 The cable carrier has to rest on the side bands and not on the stays.

Guiding in a **channel is required** for support.
 Please contact our technical support at technik@kabelschlepp.de to find the corresponding guide channel.
 Please note the operating and installation height.



Subject to change without notice.

PROTUM® series
K series
UNIFLEX Advanced series
M series
XL series
QUANTUM® series
TKR series
TKA series
UAT series

Aluminum stay RMR – Frame rolling stay

- Aluminum profile bars with rotating plastic rolling stay for highest requirements with gentle cable guiding. Double threaded joint on both sides.
- Available customized in **1 mm grid**.
- **Inside/outside:** Threaded joint easy to release.



Stay arrangement on every 2nd chain link, **standard** (HS: half-stayed)



Stay arrangement on each chain link (**VS: fully-stayed**)



1 mm B_i 100 – 800 mm in **1 mm width sections**

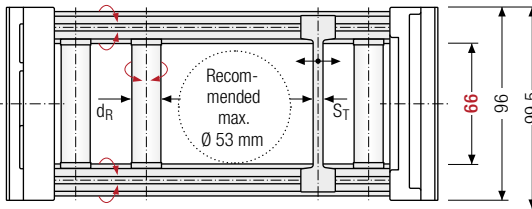

Calculating the cable carrier length

Cable carrier length L_k

$$L_k \approx \frac{L_s}{2} + L_B$$

Cable carrier length L_k rounded to pitch t

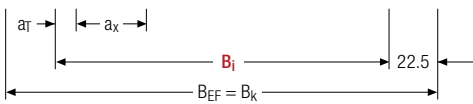

Push-to-connect glide shoes for long travel lengths
KR_{min} = 180 mm



The maximum cable diameter strongly depends on the bending radius and the desired cable type. Please contact us.



For rough environmental conditions, we recommend the use of OFFROAD glide shoes with 80 % higher wear volume.

h _i [mm]	h _G [mm]	h _{G'} [mm]	h _{G'} Offroad [mm]	B _i [mm]*	B _k [mm]	B _{EF} [mm]	d _R [mm]	S _T [mm]	a _T min [mm]	a _x min [mm]	KR [mm]	q _k [kg/m]
66	96	99.5	103	100 – 800	B _i + 45	B _i + 45	10	6	6.5	37	180 220 260 300 340 380 500	4.13 – 8.39

* in 1 mm width sections

Order example



MC1250

Type

400

B_i [mm]

RMR

Stay variant

300

KR [mm]

4250

L_k [mm]

HS

Stay arrangement



Subject to change without notice.

PROTUM®
series

K
series

UNIFLEX
Advanced
series

M
series

XL
series

QUANTUM®
series

TKR
series

TKA
series

UAT
series

Plastic stay RE – screw-in frame stay

- Plastic profile bars for light to medium loads.
Assembly without screws.
- Available customized in **16 mm grid**.
- **Outside/inside:** release by turning by 90°.

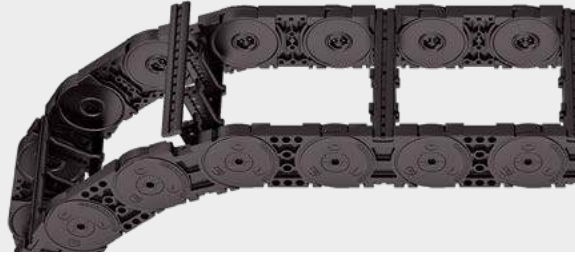

Stay arrangement on every
2nd chain link, **standard**
(**HS: half-stayed**)



Stay arrangement on each
chain link (**VS: fully-stayed**)



16 mm B_i 71 – 551 mm
in **16 mm** width sections

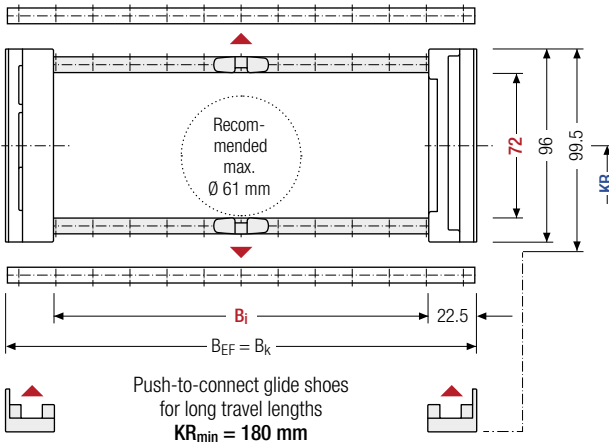

The maximum cable diameter strongly depends on the bending radius and the desired cable type. Please contact us.



For rough environmental conditions, we recommend the use of OFFROAD glide shoes with 80 % higher wear volume.

Calculating the cable carrier length

Cable carrier length L_k

$$L_k \approx \frac{L_s}{2} + L_B$$

Cable carrier length L_k
rounded to pitch t

h_i [mm]	h_G [mm]	$h_{G'}$ [mm]	$h_{G'}$ Offroad [mm]	B_i [mm]					B_k [mm]	B_{EF} [mm]	KR [mm]	q_k [kg/m]			
72	96	99.5	103	71	87	103	119	135	151	167	B_i + 45	B_i + 45	180	220	4.30
				183	199	215	231	247	263	279			260	300	
				295	311	327	343	359	375	391			340	380	
				407	423	439	455	471	487	503			500		
				519	535	551									
												5.80			

Order example



ME1250
Type

407
 B_i [mm]

RE
Stay variant

300
 KR [mm]

4250
 L_k [mm]

HS
Stay arrangement

Plastic stay RD – Frame stay with hinge



- Plastic profile bars with hinge for light to medium loads. Assembly without screws.
- Available customized in **16 mm grid**.
- **Outside:** swivable to both sides.
- **Inside:** release by turning by 90°.

 Stay arrangement on every 2nd chain link, **standard** (HS: half-stayed)

 Stay arrangement on each chain link (**VS: fully-stayed**)

 **16 mm** B_i 71 – 551 mm in **16 mm** width sections

PROTUM® series

K series

UNIFLEX Advanced series

M series

XL series

QUANTUM® series

TKR series

TKA series

UAT series

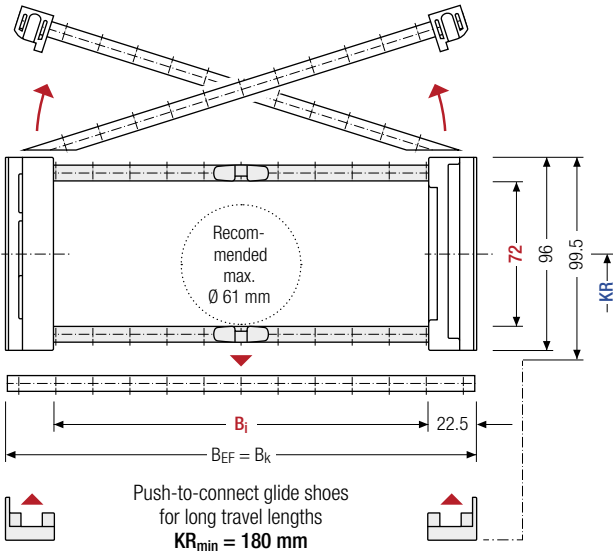

 The maximum cable diameter strongly depends on the bending radius and the desired cable type. Please contact us.

 For rough environmental conditions, we recommend the use of OFFROAD glide shoes with 80 % higher wear volume.

Calculating the cable carrier length

Cable carrier length L_k

$$L_k \approx \frac{L_s}{2} + L_B$$

Cable carrier length L_k rounded to pitch t

h _i [mm]	h _G [mm]	h _{G'} [mm]	h _{G'} Offroad [mm]	B _i [mm]					B _k [mm]	B _{EF} [mm]	KR [mm]	q _k [kg/m]			
72	96	99.5	103	71	87	103	119	135	151	167	B _i + 45	B _i + 45	180	220	4.30 – 5.80
				183	199	215	231	247	263	279			260	300	
				295	311	327	343	359	375	391			340	380	
				407	423	439	455	471	487	503			500		
				519	535	551									

Order example

MK1250 Type ·
 407 B_i [mm] ·
 RD Stay variant ·
 300 KR [mm] ·
 4250 L_k [mm] ·
 HS Stay arrangement

Divider systems

As a standard, the divider system is mounted on each crossbar – for stay mounting on every 2nd chain link (HS).

As a standard, dividers and the complete divider system (dividers with height separations) can be moved in the cross section (**version A**).

The dividers are easily attached to the stay for applications with lateral acceleration and for applications laying on their side by simply turning the frame stay by 180°. The arresting cams click into place in the locking grids in the crossbars (**version B**).

The groove in the frame stay faces outwards.

Divider system TS0 without height separation

Vers.	a_T min [mm]	a_x min [mm]	a_c min [mm]	a_x grid [mm]	n_T min
A	5	14.5	6.5	—	—
B	19.5	16	8	16	—

The dividers can be moved within the cross section (version A) or fixed (version B).

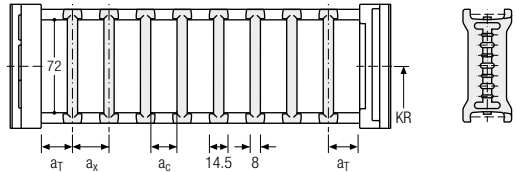

Divider system TS1 with continuous height separation

Vers.	a_T min [mm]	a_T max [mm]	a_x min [mm]	a_c min [mm]	a_x grid [mm]	n_T min
A	5	25	14.5	6.5	—	2
B	19.5	19.5	16	8	16	2

The dividers can be moved within the cross section (version A) or fixed (version B).

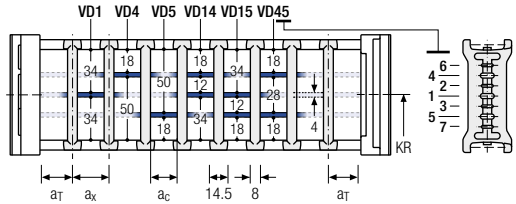

Divider system TS2 with partial height separation

Vers.	a_T min [mm]	a_x min [mm]	a_c min [mm]	a_x grid [mm]	n_T min
A	5	14.5*20	6.5*12	—	2
B	19.5	16*32	8*24	16	2

* for VR0

With grid distribution (**16 mm grid**). The dividers are fixed by the height separation, the complete divider system is movable in the cross section (version A) or fixed (version B).

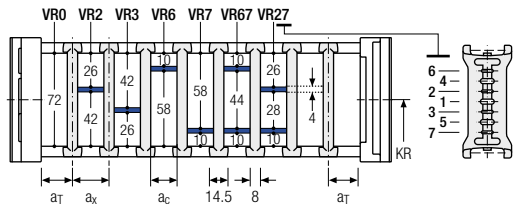

Divider system TS3 with height separation made of plastic partitions

Vers.	a _T min [mm]	a _x min [mm]	a _c min [mm]	n _T min
A	4	16 / 42*	8	2

* For aluminum partitions

The dividers are fixed by the partitions, the complete divider system is movable in the cross section.

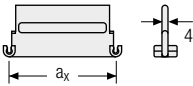
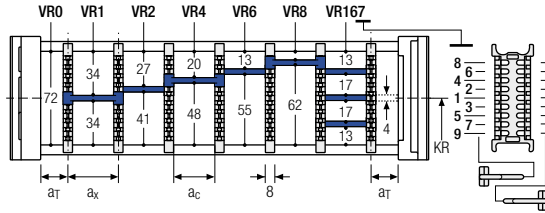

Aluminum partitions in 1 mm increments with a_x > 42 mm are also available.

a _x (center distance of dividers) [mm]											
a _c (nominal width of inner chamber) [mm]											
16	18	23	28	32	33	38	43	48	58	64	68
8	10	15	20	24	25	30	35	40	50	56	60
78	80	88	96	112	128	144	160	176	192	208	
70	72	80	88	104	120	136	152	168	184	200	

When using plastic partitions with a_x > 112 mm, we recommend an additional center support with a twin divider (S_T = 4 mm). Twin dividers are also suitable for retrofitting in the partition system.

Order example

TS3

A

3

K1

34

VR1

⋮
 ⋮
 ⋮

K4

38

VR3

Divider system Version n_T Chamber a_x Height separation

Please state the designation of the divider system (TS0, TS1 ...), version and number of dividers per cross section [n_T]. In addition, please also enter the chambers [K] from left to right, as well as the assembly distances [a_T/a_x] (as seen from the driver).

If using divider systems with height separation (TS1, TS3) please also state the positions [e.g. VD23] viewed from the left driver belt. You are welcome to add a sketch to your order.

More product information online



Assembly instructions etc.: Additional info via your smartphone or check online at tsubaki-kabelschlepp.com/downloads



Configure your custom cable carrier: here online-engineer.de

- PROTUM® series
- K series
- UNIFLEX Advanced series
- M series
- XL series
- QUANTUM® series
- TKR series
- TKA series
- UAT series

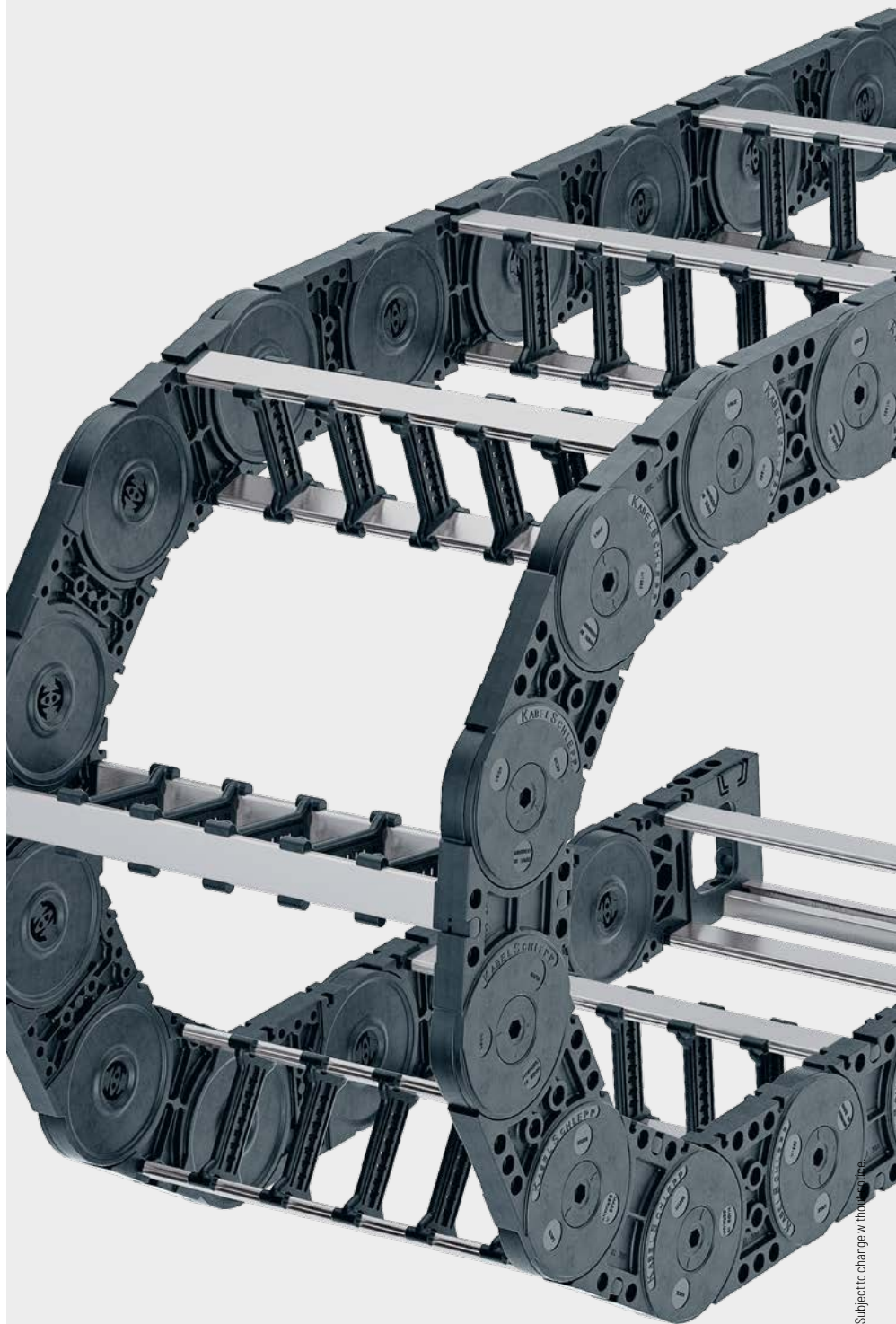
PROTUM®
seriesK
seriesUNIFLEX
Advanced
seriesM
seriesXL
seriesQUANTUM®
seriesTKR
seriesTKA
seriesUAT
series

M1300



Pitch
130 mm



Inner height
87 – 98 mm



Inner widths
100 – 800 mm



Bending radii
150 – 500 mm

Stay variants

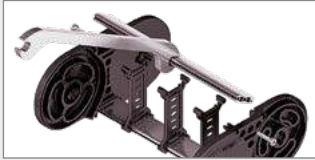

Aluminum stay RMF page 442

Frame stay solid with optional fixing profile

- » Aluminum profile bars for heavy loads and large cable carrier widths. Easy threaded connection.
- » **Inside/outside:** Threaded joint easy to release.

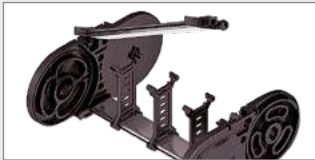

Aluminum stay RMS page 444

Frame stay solid with ball joint

- » Aluminum profile bars with plastic ball joint for heavy loads and large cable carrier widths. Assembly without screws.
- » **Inside/outside:** Swivable and detachable.

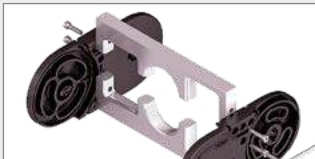

Aluminum stay LG page 446

Hole stay, split version

- » Optimum cable routing in the neutral bending line. Split version for easy cable routing. Stays also available unsplit.
- » **Outside/inside:** Screw-fixing easy to release.

Unsupported arrangement

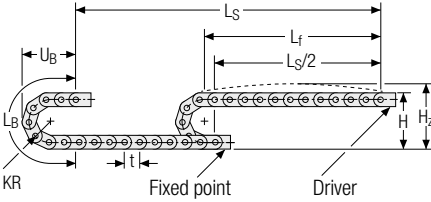

KR [mm]	H [mm]	H ₂ [mm]	L _B [mm]	U _B [mm]
150	480	540	732	340
195	570	630	873	385
240	660	720	1014	430
280	740	800	1140	470
320	820	880	1266	510
360	900	960	1391	550
400	980	1040	1517	590
500	1180	1240	1831	690

Load diagram for unsupported length depending on the additional load.

Sagging of the cable carrier is technically permitted for extended travel lengths, depending on the specific application.

Intrinsic cable carrier weight $q_k = 8.0 \text{ kg/m}$. For other inner widths, the maximum additional load changes.

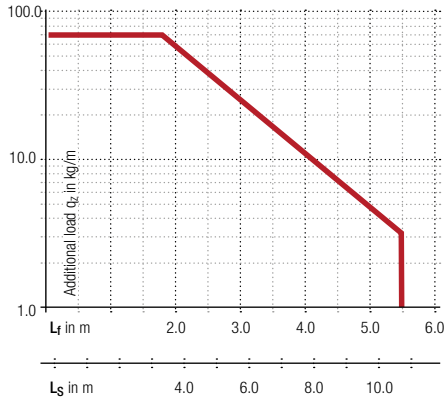

- Speed**
up to 10 m/s
- Acceleration**
up to 25 m/s²
- Travel length**
up to 10.8 m
- Additional load**
up to 70 kg/m

Gliding arrangement | GO module with chain links optimized for gliding

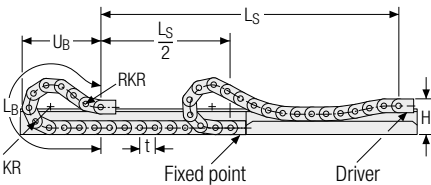

KR [mm]	H [mm]	GO module RKR [mm]	L _B [mm]	U _B [mm]
195	360	500	2210	1040
240	360	500	2470	1125
320	360	500	2880	1240
360	360	500	3140	1331
500	360	500	4310	1756

The cable carrier is to be used gliding only **without pre-tensioning!**

- Speed**
up to 8 m/s
 - Acceleration**
up to 20 m/s²
 - Travel length**
up to 350 m
 - Additional load**
up to 70 kg/m
- The gliding cable carrier must be guided in a channel. See p. 844.
- The GO module mounted on the driver is a defined sequence of 4 adapted KR/RKR link plates.
- Gliding shoes are required for gliding applications.

Subject to change without notice.

Our technical support can provide help for gliding arrangements:
technik@kabelschlepp.de

PROTUM® series

K series

UNIFLEX Advanced series

M series

XL series

QUANTUM® series

TKR series

TKA series

UAT series

Aluminum stay RMF – frame stay solid with optional fixing profile

- Aluminum profile bars for heavy loads and large cable carrier widths. Easy threaded connection.
- Available customized in **1 mm grid**.
- **Inside/outside**: Threaded joint easy to release.

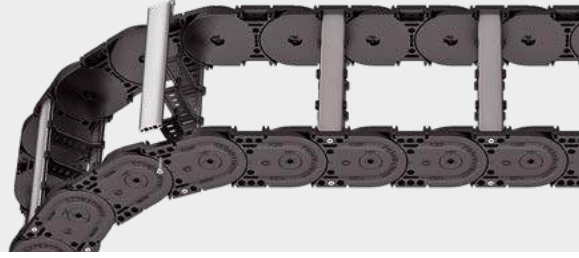

Stay arrangement on every 2nd chain link, **standard** (HS: half-stayed)



Stay arrangement on each chain link (**VS: fully-stayed**)



1 mm B_i 100 – 800 mm in **1 mm width sections**

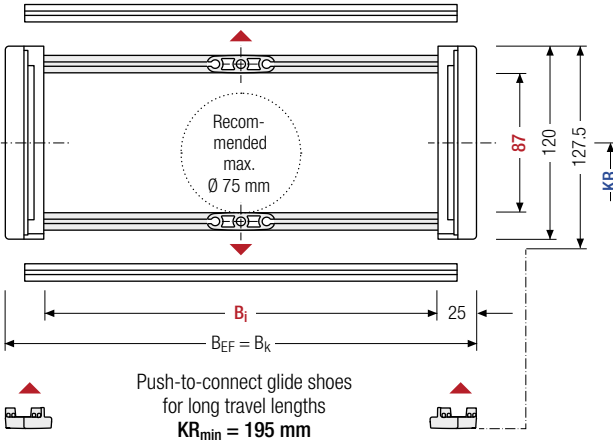

The maximum cable diameter strongly depends on the bending radius and the desired cable type. Please contact us.

Calculating the cable carrier length

Cable carrier length L_k

$$L_k \approx \frac{L_S}{2} + L_B$$

Cable carrier length L_k rounded to pitch t

h_i [mm]	h_G [mm]	h_G^* [mm]	B_i [mm]*	B_k [mm]	B_{EF} [mm]	KR [mm]				q_k [kg/m]
87	120	127.5	100 – 800	$B_i + 50$	$B_i + 50$	150	195	240	280	6.24 – 9.59
						320	360	400	500	

* in 1 mm width sections

Order example



MC1300

Type

400

B_i [mm]

RMF

Stay variant

360

KR [mm]

6500

L_k [mm]

HS

Stay arrangement

Divider systems

As a standard, the divider system is mounted on each crossbar – for stay mounting on every 2nd chain link (HS). As a standard, dividers and the complete divider system (dividers with height separations) can be moved in the cross section (**version A**).

For applications with lateral acceleration and lying on the side, the dividers can be attached by simple insertion of a fixing profile into the RMF stay, available as an accessory (**version B**).

Divider system TS0 without height separation

Vers.	a _T min [mm]	a _x min [mm]	a _c min [mm]	a _x Raster [mm]	πT min
A	7.5	15	10	–	–
B	10	15	10	5	–

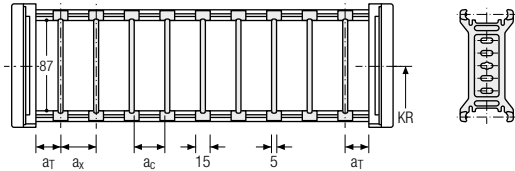

The dividers can be moved within the cross section (version A) or fixed (version B).

Divider system TS1 with continuous height separation

Vers.	a _T min [mm]	a _T max [mm]	a _x min [mm]	a _c min [mm]	a _x Raster [mm]	πT min
A	7.5	25	15	10	–	2
B	10	25	15	10	5	2

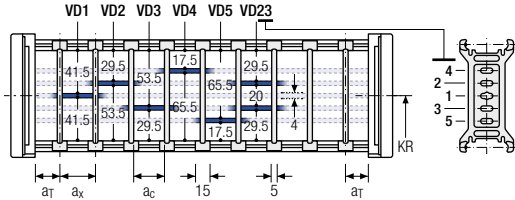

The dividers can be moved within the cross section (version A) or fixed (version B).

Divider system TS3 with partial height separation

Vers.	a _T min [mm]	a _x min [mm]	a _c min [mm]	πT min
A	7.5	16/42*	8	2

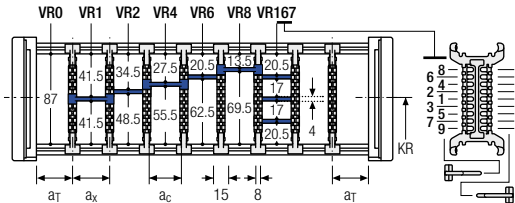

* For aluminum partitions

With grid distribution (1 mm grid). The dividers are attached by the height separation, the grid can be moved in the cross section.

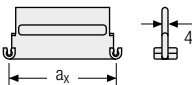

Aluminum partitions in 1 mm increments with a_x > 42 mm are also available.

a _x (center distance of dividers) [mm]											
a _c (nominal width of inner chamber) [mm]											
16	18	23	28	32	33	38	43	48	58	64	68
8	10	15	20	24	25	30	35	40	50	56	60
78	80	88	96	112	128	144	160	176	192	208	
70	72	80	88	104	120	136	152	168	184	200	

When using plastic partitions with a_x > 112 mm, we recommend an additional center support with a twin divider (S_T = 5 mm). Twin dividers are also suitable for retrofitting in the partition system. The height separations VR8 and VR9 are not possible when using twin dividers.

PROTUM® series
K series
UNIFLEX Advanced series
M series
XL series
QUANTUM® series
TKR series
TKA series
UAT series

Aluminum stay RMS – frame stay reinforced

- Aluminum profile bars with plastic ball joint for heavy loads and large cable carrier widths. Assembly without screws.
- Available customized in **1 mm grid**.
- **Inside/outside:** Swivable and detachable.

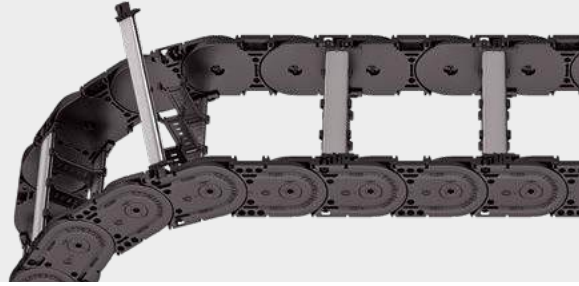

Stay arrangement on every 2nd chain link, **standard (HS: half-stayed)**



Stay arrangement on each chain link (**VS: fully-stayed**)



1 mm B_i 100 – 800 mm in **1 mm width sections**

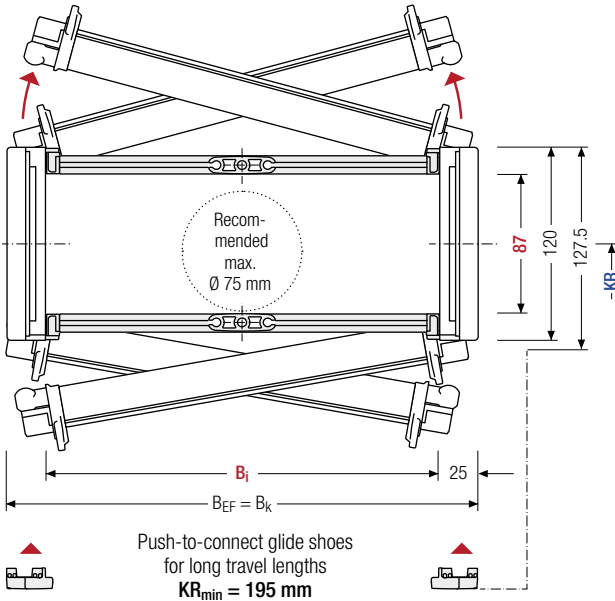

The maximum cable diameter strongly depends on the bending radius and the desired cable type. Please contact us.

Calculating the cable carrier length

Cable carrier length L_k

$$L_k \approx \frac{L_S}{2} + L_B$$

Cable carrier length L_k rounded to pitch t

h_i [mm]	h_G [mm]	h_G^* [mm]	B_i [mm]*	B_k [mm]	B_{EF} [mm]	KR [mm]				q_k [kg/m]
87	120	127.5	100 – 800	$B_i + 50$	$B_i + 50$	150	195	240	280	6.31 – 9.65
						320	360	400	500	

* in 1 mm width sections

Order example



MC1300

Type

400

B_i [mm]

RMS

Stay variant

360

KR [mm]

6500

L_k [mm]

HS

Stay arrangement

Aluminum stay LG – Hole stay, split version

- Optimum cable routing in the neutral bending line.
Split version for easy cable routing. Stays also available unsplit.
- Available customized in **1 mm width sections**.
- **Outside/inside:** Screw-fixing easy to release.

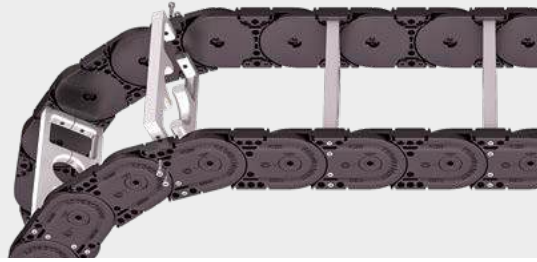

Stay arrangement on every 2nd chain link, **standard** (HS: half-stayed)



Stay arrangement on each chain link (VS: fully-stayed)



1 mm B_i 100 – 800 mm
in 1 mm width sections

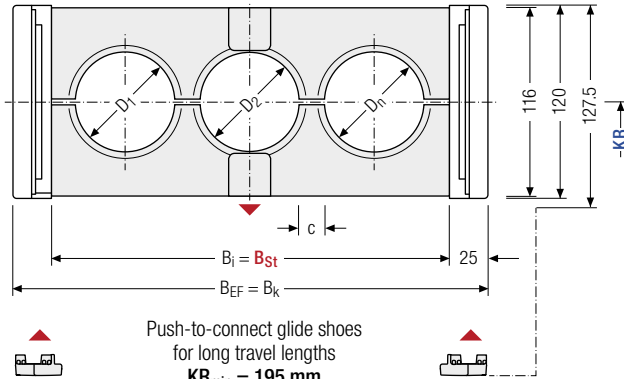
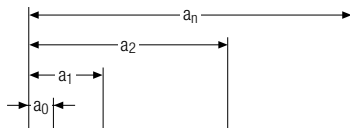

The maximum cable diameter strongly depends on the bending radius and the desired cable type. Please contact us.

Calculating the cable carrier length

Cable carrier length L_k

$$L_k \approx \frac{L_s}{2} + L_B$$

Cable carrier length L_k rounded to pitch t

Calculating the stay width

Stay width B_{St}

$$B_{St} = \sum D + \sum c + 2 a_0$$

D _{max} [mm]	D _{min} [mm]	h _g [mm]	B _i [mm]	B _{St} [mm]*	B _k [mm]	B _{EF} [mm]	c _{min} [mm]	a _{0 min} [mm]	KR [mm]	q _k 50 %** [kg/m]
98	12	120	100 – 800	100 – 800	B _{St} + 50	B _{St} + 50	4	13	150	7.04
									195	13.53
									240	
									280	
									320	
									400	
									500	

* in 1 mm width sections

** Hole ratio of the hole stay approx. 50 %

Order example



MC1300

Type

400

B_i [mm]

LG

Stay variant

360

KR [mm]

6500

L_k [mm]

HS

Stay arrangement

Universal end connectors UMB – plastic (standard)

The universal mounting brackets (UMB) are made from plastic and can be mounted **from the top, from the bottom, face on or from the side.**

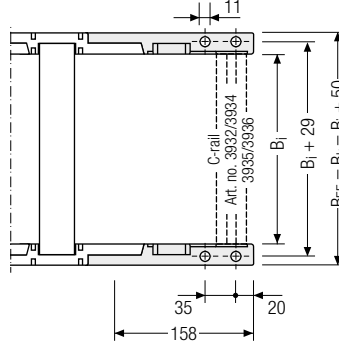
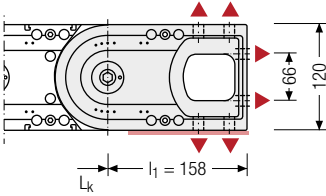

▲ Assembly options

i Recommended tightening torque: 54 Nm for cheese-head screws ISO 4762 - M10 - 8.8

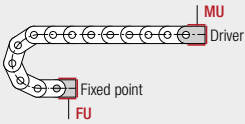

Connection point

- F – fixed point
- M – driver

Connection type

- U – universal mounting bracket

Order example

	UMB	.	F	A
	UMB	.	M	A
	End connector		Connection point	Connection type

i We recommend the use of strain reliefs at the driver and fixed point. See from p. 904.

More product information online



Assembly instructions etc.: Additional info via your smartphone or check online at tsubaki-kabelschlepp.com/downloads



Configure your custom cable carrier here: online-engineer.de

PROTUM® series
K series
UNIFLEX Advanced series
M series
XL series
QUANTUM® series
TKR series
TKA series
UAT series

XL series

Cable carrier with
large inside height

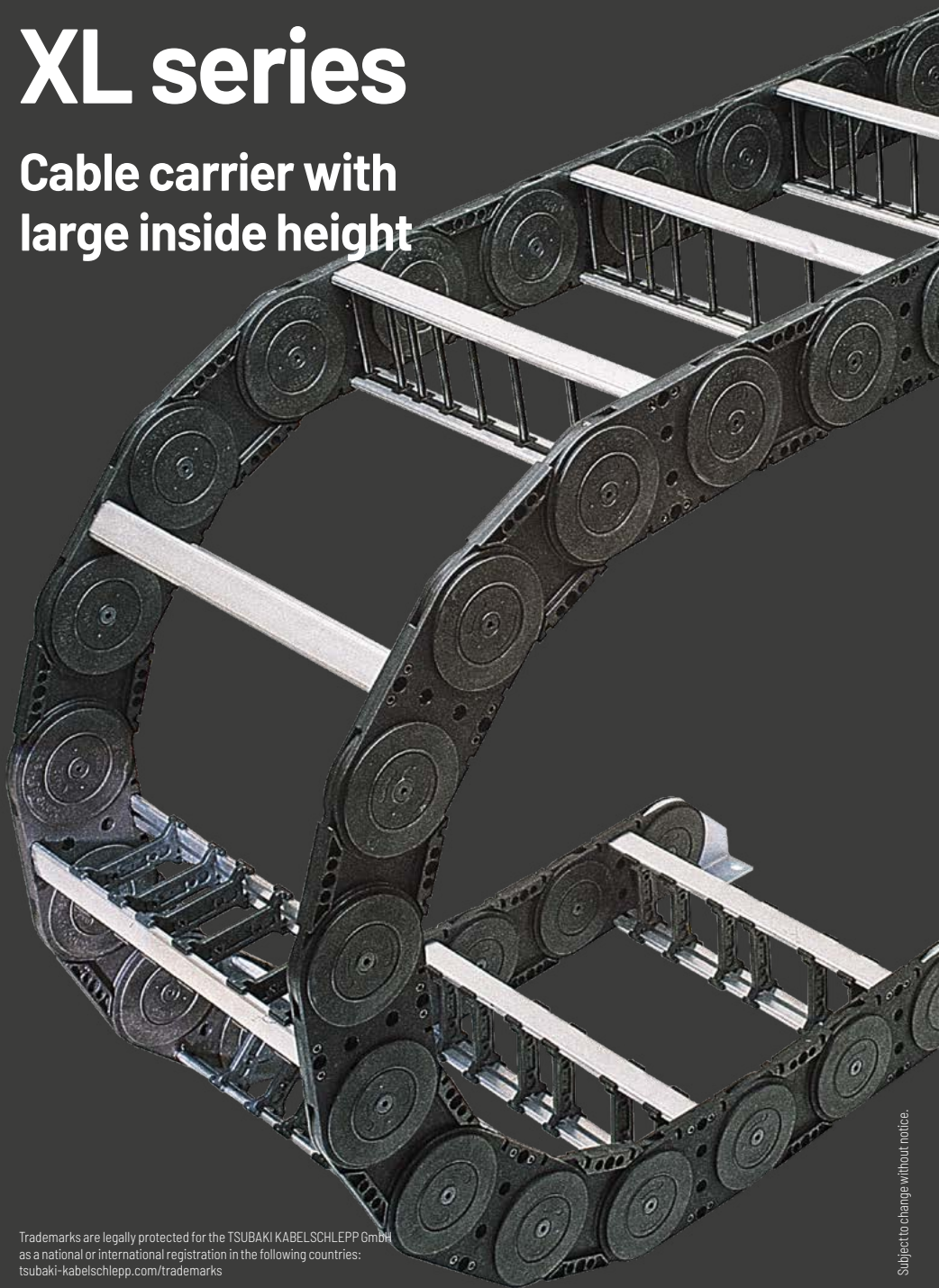

Trademarks are legally protected for the TSUBAKI KABELSCHLEPP GmbH
as a national or international registration in the following countries:
tsubaki-kabelschlepp.com/trademarks

Subject to change without notice.

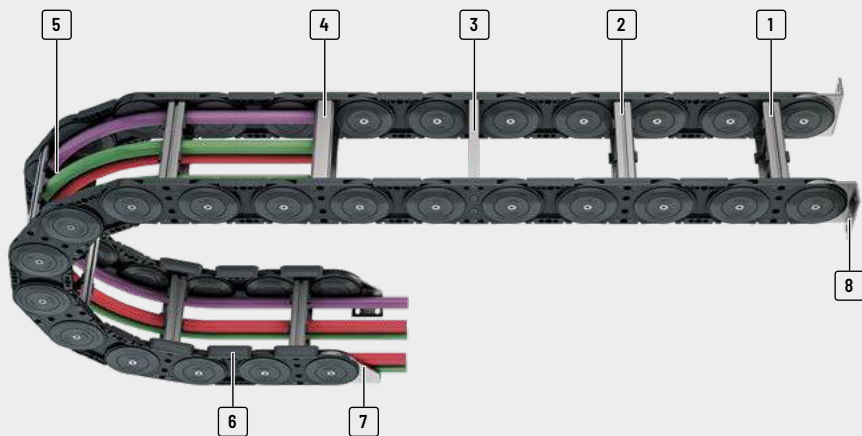

- | | | |
|--|--|---|
| <p>1 Aluminum stays available in 1 mm width sections</p> <p>2 Aluminum stays with 4 screw-fixing points for extreme loads</p> <p>3 Aluminum hole stays</p> | <p>4 Plastic rolling stays</p> <p>5 Can be opened on the inside and the outside for installation of cables and hoses</p> <p>6 Replaceable glide shoes</p> | <p>7 Sturdy end connectors made of steel</p> <p>8 Flange connection</p> |
|--|--|---|

Features

- » Sizes/dimensions
- » Low intrinsic weight
- » Optimum force transmission via the large-surface stroke system (2 disc principle)
- » Plastic side bands in combination with aluminum stays
- » Versions with aluminum stays available in 1 mm width sections up to 1000 mm inner width
- » Can be opened on both sides
- » Large selection of stay systems and separating options for cables
- » Optionally with strain relief

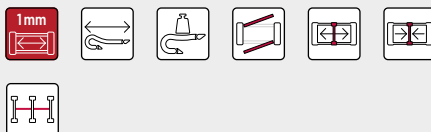

Bolted stays for maximum stability even for large cable carrier widths



Replaceable glide shoes for long service life for gliding applications



Sturdy end connectors made of steel (different connection variants)



Many separation options for the cables

PROTUM®
series

K
series

UNIFLEX
Advanced
series

M
series

XL
series

QUANTUM®
series

TKR
series

TKA
series

UAT
series

Type	Opening variant	Stay variant	h_i [mm]	h_G [mm]	B_i [mm]	B_k [mm]	B_i - grid [mm]	t [mm]	KR [mm]	Additional load ≤ [kg/m]	Cable- d _{max} [mm]
XL1650											
		RM	108	140	200 - 1000	268 - 1068	1	165	250 - 550	65	86
		LG	110	140	200 - 1000	268 - 1068	1	165	250 - 550	65	88
		RMR	108	140	200 - 1000	268 - 1068	1	165	250 - 550	65	84

* Further information on request.



XLT series

Also available as covered versions with covers system. More information can be found in chapter "XLT series" from page 658.

Unsupported arrangement			Gliding arrangement			Inner Distribution				Movement			Page
Travel length $\leq [m]$	$v_{max} \leq [m/s]$	$a_{max} \leq [m/s^2]$	Travel length $\leq [m]$	$v_{max} \leq [m/s]$	$a_{max} \leq [m/s^2]$	TS0	TS1	TS2	TS3	vertical hanging or standing	lying on the side	rotating arrangement	
11.75	4	25	350	2	2-3	•	-	-	•	•	•	•	454
11.75	4	25	350	2	2-3	-	-	-	-	•	•	•	*
11.75	4	25	350	2	2-3	•	-	-	-	•	•	•	*

PROTUM® series

K series

UNIFLEX Advanced series

M series

XL series

QUANTUM® series

TKR series

TKA series

UAT series

XL1650



Pitch
165 mm



Inner height
108 mm



Inner widths
200 - 1000 mm



Bending radii
250 - 550 mm

Stay variants



Aluminum stay RM..... page 454

Frame stay, solid

- » Aluminum profile bars for heavy loads and maximum cable carrier widths. Double threaded joints on both sides "Heavy Duty".
- » **Inside/outside:** Threaded joints easy to release.

Additional stay variants on request



Aluminum stay LG

Optimum cable routing in the neutral bending line.



Aluminum stay RMR

Gentle cable guiding with rollers.

Unsupported arrangement

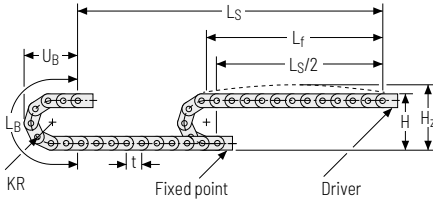





KR [mm]	H [mm]	H ₂ [mm]	L _B [mm]	U _B [mm]
250	640	740	1115	485
300	740	840	1272	535
350	840	940	1430	585
400	940	1040	1587	635
450	1040	1140	1744	685
500	1140	1240	1901	735
550	1240	1340	2058	785

Load diagram for unsupported length depending on the additional load.

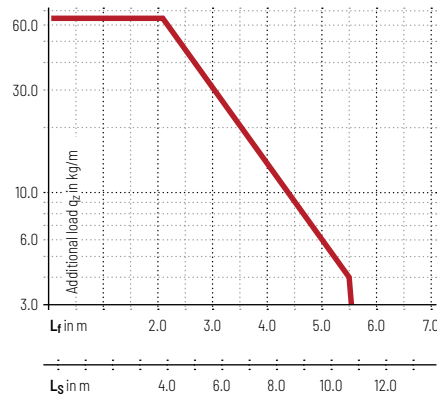
Sagging of the cable carrier is technically permitted for extended travel lengths, depending on the specific application.





Intrinsic cable carrier weight $q_k = 13 \text{ kg/m}$. For other inner widths, the maximum additional load changes.

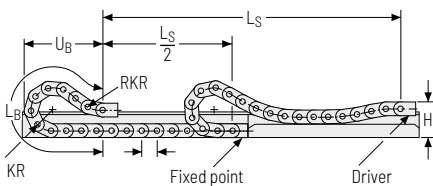

-  **Speed**
up to 4 m/s
-  **Acceleration**
up to 25 m/s²
-  **Travel length**
up to 11.75 m
-  **Additional load**
up to 65 kg/m

Gliding arrangement



-  **Speed**
up to 2 m/s
-  **Acceleration**
up to 2 - 3 m/s²
-  **Travel length**
up to 350 m
-  **Additional load**
up to 65 kg/m

 The gliding cable carrier must be guided in a channel. See p. 844.

We recommend the use of glide shoes for gliding applications.

 Our technical support can provide help for gliding arrangements: technik@kabelschlepp.de

Aluminum stay RM – Frame stay, solid

- » Aluminum profile bars for heavy loads and maximum cable carrier widths. Double threaded joints on both sides “**Heavy Duty**”.
- » Available customized in **1 mm grid**.
- » **Inside/outside:** Threaded joints easy to release.

HEAVY DUTY
TSUBAKI KABELSCHLEPP



Stay arrangement on every 2nd chain link, **standard** (HS: half-stayed)



Stay arrangement on each chain link (**VS: fully-stayed**)



1mm B_i 200 – 1000 mm
in **1 mm width sections**

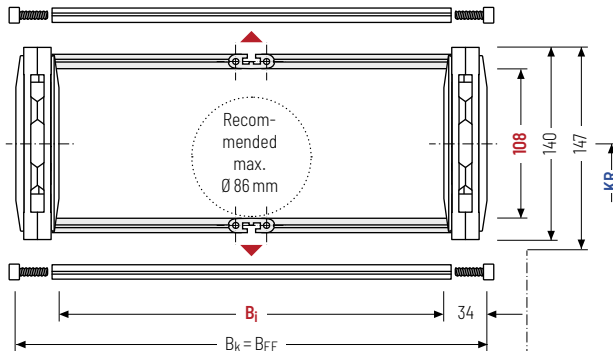

The maximum cable diameter strongly depends on the bending radius and the desired cable type. Please contact us.

Calculating the cable carrier length

Cable carrier length L_k

$$L_k \approx \frac{L_S}{2} + L_B$$

Cable carrier length L_k
rounded to pitch t



Push-to-connect glide shoes
for long travel lengths



h_i [mm]	h_g [mm]	h_g' [mm]	B_i [mm]*	B_k [mm]	B_{EF} [mm]	KR [mm]						q_k [kg/m]	
108	140	147	200 – 1000	$B_i + 68$	$B_i + 68$	250	300	350	400	450	500	550	10.5 – 15.3

* in 1 mm width sections

Order example



XLC1650

Type

600

B_i [mm]

RM

Stay variant

350

KR [mm]

4125

L_k [mm]

HS

Stay arrangement

Divider systems

The divider system is mounted on each crossbar as a standard – on every 2nd chain link for stay mounting (HS).

As a standard, dividers or the complete divider system (dividers with height separations) are movable in the cross section (**version A**).

Divider system TSO without height separation

Vers.	a _T min [mm]	a _x min [mm]	a _c min [mm]	n _T min
A	6	25	17	-

The dividers can be moved in the cross section.

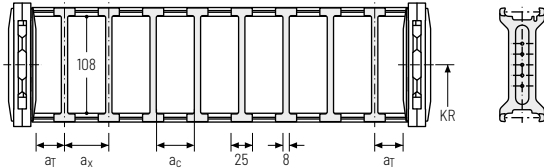

Divider system TS3 with height separation consisting of plastic partitions

Vers.	a _T min [mm]	a _x min [mm]	a _c min [mm]	n _T min
A	1	16 / 42*	8	2

* For aluminum partitions

The dividers are fixed with the partitions. The entire divider system can be moved in the cross section.

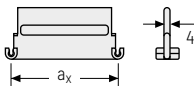
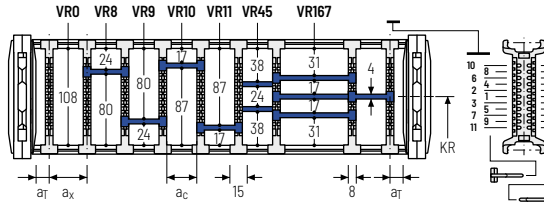
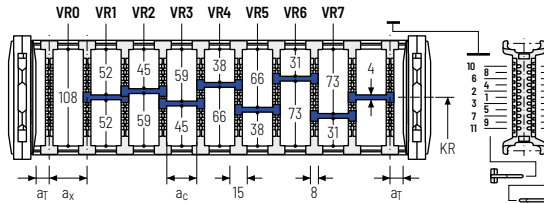

Aluminum partitions in 1 mm increments with a_x > 42 mm are also available.

a _x (center distance of dividers) [mm]											
a _c (nominal width of inner chamber) [mm]											
16	18	23	28	32	33	38	43	48	58	64	68
8	10	15	20	24	25	30	35	40	50	56	60
78	80	88	96	112	128	144	160	176	192	208	
70	72	80	88	104	120	136	152	168	184	200	

When using plastic partitions with a_x > 112 mm, we recommend an additional center support with a twin divider (S_T = 5 mm). Twin dividers are also suitable for retrofitting in the partition system.

Order example

TS3

A

3

K1

34

VR1

.

K4

38

VR3

Divider system
Version
n_T
Chamber
a_x
Height separation

Please state the designation of the divider system (**TS0, TS3**), the version, and the number of dividers per cross section [n_T]. In addition, please also enter the chambers [K] from left to right, as well as the assembly distances [a_T/a_x].

PROTUM®
seriesK
seriesUNIFLEX
Advanced
seriesM
series**XL
series**QUANTUM®
seriesTKR
seriesTKA
seriesUAT
series

QUANTUM[®] series

Light, extremely quiet and
low-vibration for high speeds
and accelerations

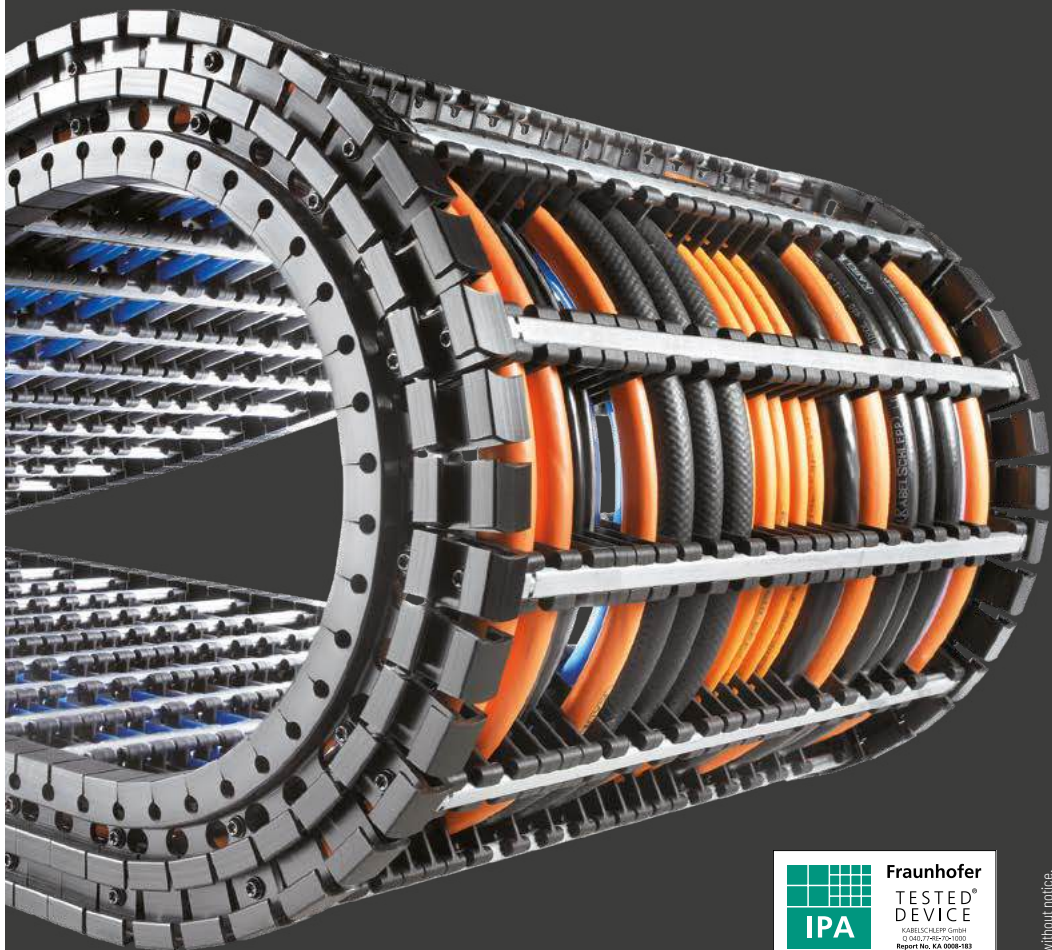

Fraunhofer

TESTED[®]
DEVICE
KABELSCHLEPP GmbH
© 2016, 27. April 2016
Report No. KA 0008-183

Trademarks are legally protected for the TSUBAKI KABELSCHLEPP GmbH
as a national or international registration in the following countries:
tsubaki-kabelschlepp.com/trademarks

Subject to change without notice.

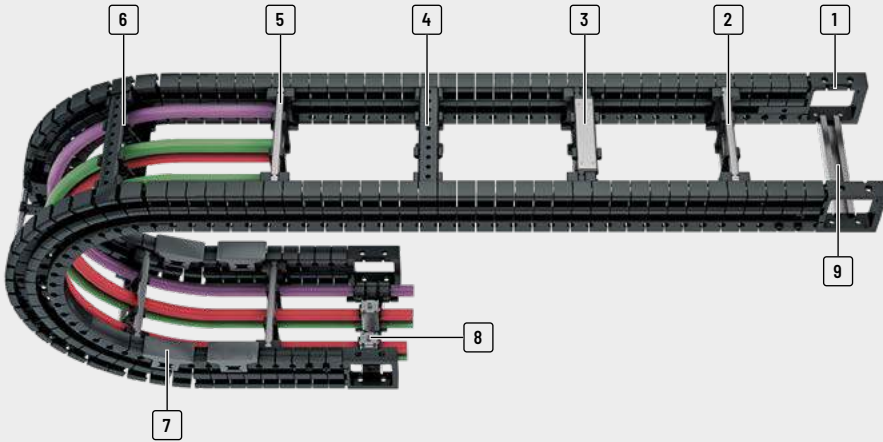

- 1 Universal end connectors (UMB)
- 2 Aluminum stays available in **1 mm width sections**
- 3 Aluminum stays in reinforced design
- 4 Plastic stays available in **8 or 16 mm width sections**
- 5 Can be opened quickly on the inside and the outside for cable laying
- 6 Fixable dividers
- 7 Replaceable glide shoes
- 8 Strain relief combs
- 9 C-rail for strain relief elements

Virtually no polygon effect

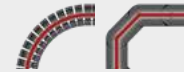

QUANTUM®
Low-vibration operation

Cable carrier with polygon effect

Features

- » Cleanroom compatible: no links, no link wear
- » Extremely quiet, 31 db (A)*
- » Extremely light
- » For high accelerations up to 300 m/s²
- » For high operating speeds up to 40 m/s
- » Extremely long service life: ≥ 25 million motion cycles
- » TÜV type tested as per 2PfG 1036/10.97
- » Large selection of stay systems and separating options for cables



* Tested: Q060.100.100 by TÜV Rheinland. The sound pressure level for the measured area was measured at a distance of 0.5 m for smooth and jerky movements.



Ideal for highly dynamic applications



3D movements: the driver connection can be moved laterally and can be rotated by up to ± 30°



Side bands made from special plastic and steel cables in the support floor for an extremely long service life

PROTUM®
series

K
series

UNIFLEX
Advanced
series

M
series

XL
series

QUANTUM®
series

TKR
series

TKA
series

UAT
series

Type	Opening variant	Stay variant	h_i [mm]	h_G [mm]	B_i [mm]	B_k [mm]	B_i - grid [mm]	t [mm]	KR [mm]	Additional load ≤ [kg/m]	Cable- d_{max} [mm]
Q040											
K series		RE	28	40	28 - 284	68 - 324	8	15	60 - 180	2.5	22
Q060											
UNIFLEX Advanced series		RS	38	60	38 - 500	90 - 552	1	20	100 - 300	5	30
		RE	42	60	68 - 276	120 - 328	8	20	100 - 300	5	33
M series											
Q080											
XL series		RS	58	80	50 - 600	122 - 672	1	25	170 - 500	8	46
		RV	58	80	50 - 600	122 - 672	1	25	170 - 500	8	46
		RE	58	80	58 - 570	130 - 642	16	25	170 - 500	8	46
QUANTUM® series		RS	72	98	70 - 600	152 - 682	1	30	180 - 600	12	57
		RV	72	98	70 - 600	152 - 682	1	30	180 - 600	12	57
		RE	72	98	74 - 570	156 - 652	16	30	180 - 600	12	57

Cleanroom compatible and long service life

Continuous side bands are used. In contrast to conventional hole-and-bolt connections, hardly any wear occurs (link abrasion), which makes QUANTUM® ideal for use in cleanrooms.

Extremely long service life through

- » No link abrasion due to absence of hole-and-bolt connections
- » Continuous side bands made from special plastic with integrated steel cables

Ideal for highly dynamic applications – extruded side bands

The QUANTUM® runs extremely quietly and with low vibrations. The absence of links and the very small pitch means that the so-called polygon effect is reduced to a minimum. Due to the very quiet running, the QUANTUM® cable carrier system is ideal for applications with low-vibration linear drives.

Unsupported arrangement			Gliding arrangement			Inner Distribution				Movement			Page
Travel length ≤ [m]	$v_{max} \leq [m/s]$	$a_{max} \leq [m/s^2]$	Travel length ≤ [m]	$v_{max} \leq [m/s]$	$a_{max} \leq [m/s^2]$	TS0	TS1	TS2	TS3	vertical hanging or standing	lying on the side	rotating arrangement	
3.2	40	300	30	2	3	•	•	•	-	•	•	-	464
<hr/>													
<hr/>													
5	30	160	50	3	2-3	•	•	•	•	•	•	-	470
5	30	160	50	3	2-3	•	•	-	•	•	•	-	474
<hr/>													
6.4	25	100	80	3	2-3	•	•	•	•	•	•	-	480
6.4	25	100	80	3	2-3	•	•	•	•	•	•	-	484
6.4	25	100	80	3	2-3	•	•	•	•	•	•	-	488
<hr/>													
7.8	20	70	95	3	2-3	•	•	-	•	•	•	-	494
7.8	20	70	95	3	2-3	•	•	•	•	•	•	-	498
7.8	20	70	95	3	2-3	•	•	•	•	•	•	-	502

PROTUM® series

K series

UNIFLEX Advanced series

M series

XL series

QUANTUM® series

TKR series

TKA series

UAT series

Q040



Pitch
15 mm



Inner height
28 mm



Inner widths
28 – 284 mm



Bending radii
60 – 180 mm

Stay variants



Plastic stay RE page 464

Frame screw-in stay

- Plastic profile bars for light to medium loads.
Assembly without screws.
- **Outside/inside:** release by rotating 90°.



TOTALTRAX® complete systems

Benefit from the advantages of the TOTALTRAX® complete system. A complete delivery from one source – with a warranty certificate on request! Learn more at tsubaki-kabelschlepp.com/totaltrax



TRAXLINE® cables for cable carriers

Hi-flex electric cables which were especially developed, optimized and tested for use in cable carriers can be found at tsubaki-kabelschlepp.com/traxline

Unsupported arrangement

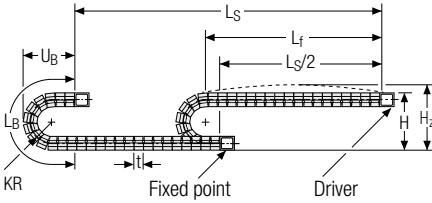





KR [mm]	H [mm]	L _B [mm]	U _B [mm]
60	175	369	178
75	205	416	193
90	235	463	208
110	275	526	228
150	355	651	268
180	415	746	298

Load diagram for unsupported length depending on the additional load.

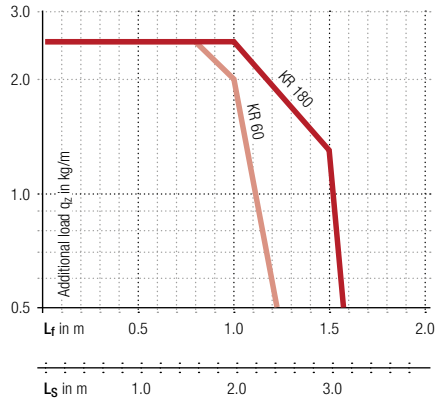
Sagging of the cable carrier is technically permitted for extended travel lengths, depending on the specific application.





Intrinsic cable carrier weight $q_k = 0.8 \text{ kg/m}$. For other inner widths, the maximum additional load changes.

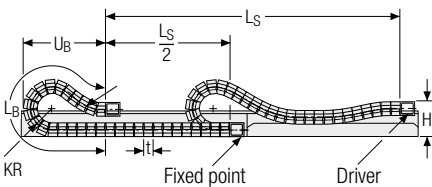

-  **Speed**
up to 40 m/s
-  **Acceleration**
up to 300 m/s²
-  **Travel length**
up to 3.2 m
-  **Additional load**
up to 2.5 kg/m

Gliding arrangement



-  **Speed**
up to 2 m/s
 -  **Acceleration**
up to 3 m/s²
 -  **Travel length**
up to 30 m
 -  **Additional load**
up to 2.5 kg/m
-  The gliding cable carrier has to be routed in a channel. See p. 844.

 Our technical support can provide help for gliding arrangements:
technik@kabelschlepp.de

PROTUM® series
K series
UNIFLEX Advanced series
M series
XL series
QUANTUM® series
TKR series
TKA series
UAT series

Plastic stay RE – screw-in frame stay

- Plastic profile bars for light to medium loads.
Assembly without screws.
- Available customized in **8 mm sections**.
- **Outside/inside:** release by rotating 90°.

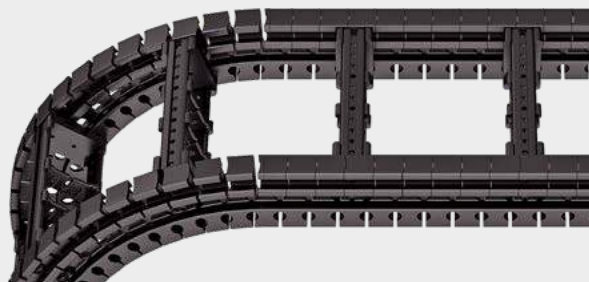

Stays on every 6th section,
standard (HS: half-stayed)



Stays on every 3rd section
(VS: fully-stayed)



8 mm B_i 28 – 284 mm in
8 mm width sections

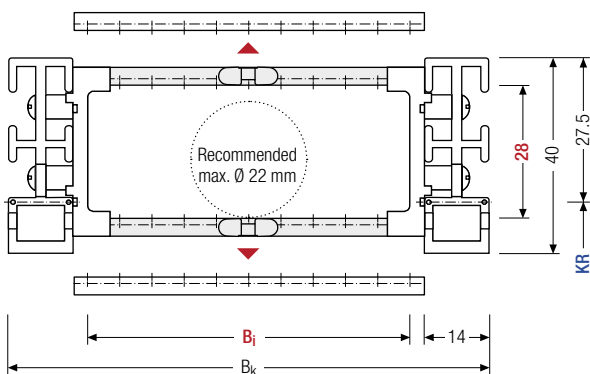

The maximum cable diameter strongly depends on the bending radius and the desired cable type. Please contact us.

Calculating the cable carrier length

Cable carrier length L_k

$$L_k \approx \frac{L_S}{2} + L_B$$

Cable carrier length L_k
rounded to pitch t

h_i [mm]	h_G [mm]	B_i [mm]											B_k [mm]	KR [mm]	q_k [kg/m]	
28	40	28	36	44	52	60	68	76	84	92	100	108	$B_i + 40$	60	75	0.63
		116	124	132	140	148	156	164	172	180	188	196		90	110	–
		204	212	220	228	236	244	252	260	268	276	284		150	180	0.98

Order example



Q040

Type

108

B_i [mm]

RE

Stay variant

150

KR [mm]

1290

L_k [mm]

HS

Stay arrangement

Divider systems

The divider system is mounted on each crossbar as a standard – on every 6th section for stay mounting (HS). As a standard, dividers or the complete divider system (dividers with height separations) are movable in the cross section (**version A**).

For applications with lateral accelerations and applications with the cable carrier rotated by 90°, the dividers can easily be fixed by turning the frame stay by 180°. The arresting cams click into place in the locking grids in the crossbar (**version B**). The groove in the frame stay faces outwards.

Divider system TSO without height separation

Vers.	a _T min [mm]	a _x min [mm]	a _c min [mm]	a _x grid [mm]	n _T min
A	8	8	5.2	–	–
B	14	8	5.2	8	–

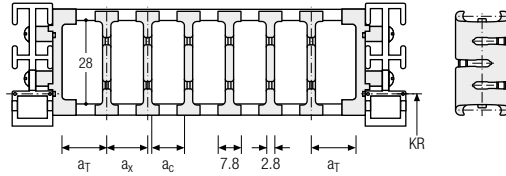

The dividers are movable within the cross section (version A) or fixed (version B).

Divider system TS1 with continuous height separation

Vers.	a _T min [mm]	a _T max [mm]	a _x min [mm]	a _c min [mm]	a _x grid [mm]	n _T min
A	8	20	8	5.2	–	2
B	14	22	8	5.2	8	2

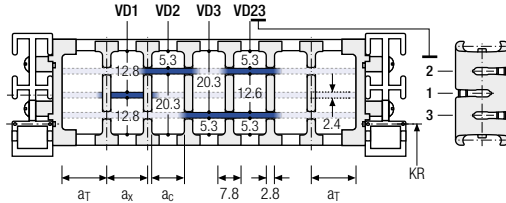

The dividers are movable within the cross section (version A) or fixed (version B).

Divider system TS2 with partial height separation

Vers.	a _T min [mm]	a _x min [mm]	a _c min [mm]	a _x grid [mm]	n _T min
B	14	8*/24	5.2*/21.2	8	2

* for VR0

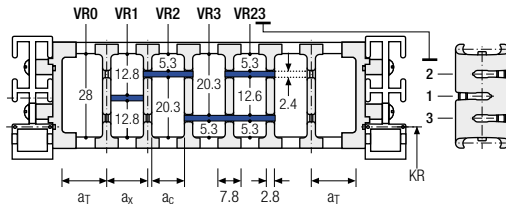

With grid distribution (8 mm grid). The dividers are attached by the height separation, the grid can be moved in the cross section (version A) or fixed (version B).

Order example

TS2

A

3

K1

34

VR1

⋮
⋮
⋮

K4

38

VR3

Divider system
Version
n_T
Chamber
a_x
Height separation

- PROTUM® series
- K series
- UNIFLEX Advanced series
- M series
- XL series
- QUANTUM® series
- TKR series
- TKA series
- UAT series

PROTUM® series

K series

UNIFLEX Advanced series

M series

XL series

QUANTUM® series

TKR series

TKA series

UAT series

Universal end connectors UMB – plastic (standard)

The universal end connectors (UMB) are made from plastic and can be mounted from the top, from the bottom or face on.

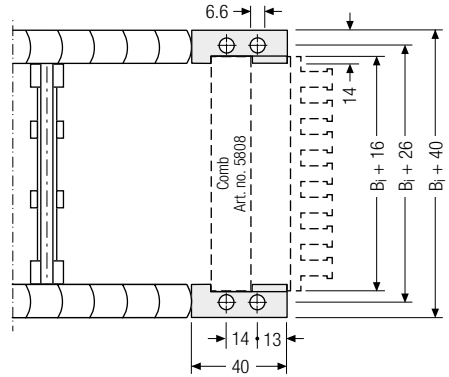
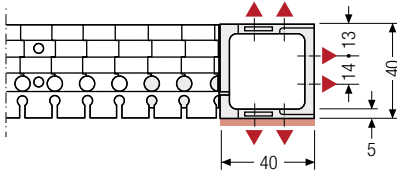

▲ Assembly options

 Recommended tightening torque:
5 Nm for screws M5 - 8.8

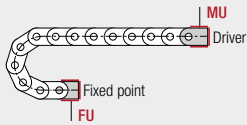

Connection point

F – fixed point
M – driver

Connection type

U – universal end connector

Order example

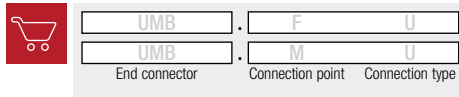

 We recommend the use of strain reliefs at the driver and fixed point. See from p. 904.

More product information online



Assembly instructions etc.:
Additional info via your smartphone or check online at tsubaki-kabelschlepp.com/downloads



Configure your custom cable carrier here:
online-engineer.de



PROTUM®
series

K
series

UNIFLEX
Advanced
series

M
series

XL
series

QUANTUM®
series

TKR
series

TKA
series

UAT
series

Q060



Pitch
20 mm



Inner heights
38 – 42 mm



Inner widths
38 – 500 mm



Bending radii
100 – 300 mm

Stay variants



Aluminum stay RS page 470

Frame stay, narrow "The standard"

- Aluminum profile bars for light to medium loads. Assembly without screws.
- **Outside/inside:** release by rotating 90°.



Plastic stay RE page 474

Frame screw-in stay

- Plastic profile bars for light to medium loads. Assembly without screws.
- **Outside/inside:** release by rotating 90°.



TOTALTRAX® complete systems

Benefit from the advantages of the TOTALTRAX® complete system. A complete delivery from one source – with a warranty certificate on request! Learn more at tsubaki-kabelschlepp.com/totaltrax



TRAXLINE® cables for cable carriers

Hi-flex electric cables which were especially developed, optimized and tested for use in cable carriers can be found at tsubaki-kabelschlepp.com/traxline

Unsupported arrangement

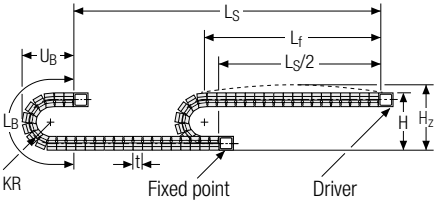





KR [mm]	H [mm]	L _B [mm]	U _B [mm]
100	288	554	264
120	328	617	284
150	388	711	314
190	468	837	354
250	588	1025	414
300	688	1182	464

Load diagram for unsupported length depending on the additional load.

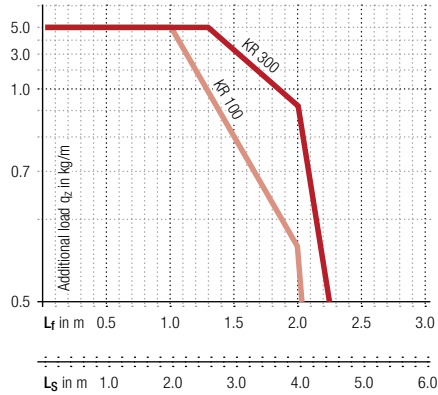
Sagging of the cable carrier is technically permitted for extended travel lengths, depending on the specific application.





Intrinsic cable carrier weight $q_k = 1.5 \text{ kg/m}$. For other inner widths, the maximum additional load changes.

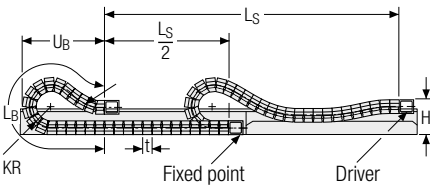

-  **Speed**
up to 30 m/s
-  **Acceleration**
up to 160 m/s²
-  **Travel length**
up to 5 m
-  **Additional load**
up to 5 kg/m

Gliding arrangement



-  **Speed**
up to 3 m/s
 -  **Acceleration**
up to 2 – 3 m/s²
 -  **Travel length**
up to 50 m
 -  **Additional load**
up to 5 kg/m
-  The gliding cable carrier has to be routed in a channel. See p. 844.
Glide shoes have to be used for gliding applications.

 Our technical support can provide help for gliding arrangements:
technik@kabelschlepp.de

Subject to change without notice.

PROTUM® series
K series
UNIFLEX Advanced series
M series
XL series
QUANTUM® series
TKR series
TKA series
UAT series

Aluminum stay RS – frame stay narrow

- Extremely quick to open and close
- Aluminum profile bars for light to medium loads.
Assembly without screws.
- Available customized in **1 mm sections**.
- Outside/inside:** release by rotating 90°.

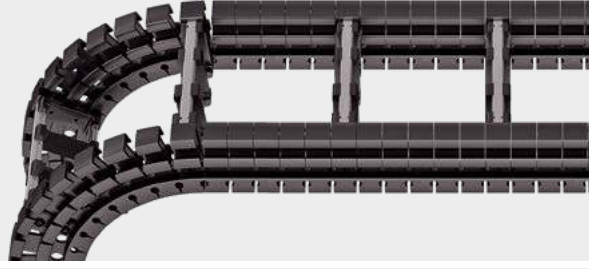

Stays on every 6th section,
standard (HS: half-stayed)



Stays on every 3rd section
(VS: fully-stayed)



1 mm B_i 38 – 500 mm in
1 mm width sections

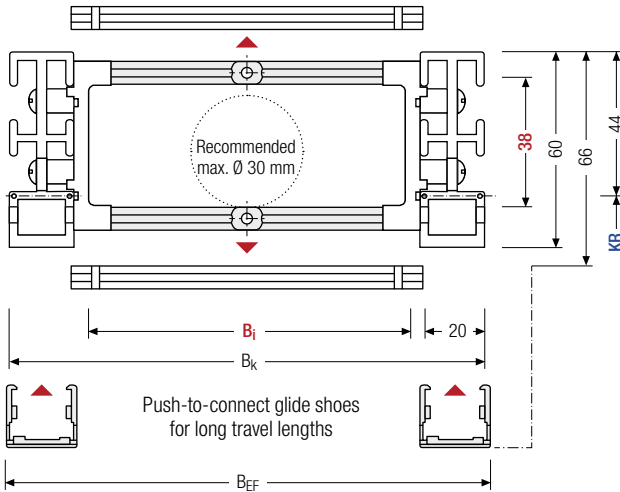

The maximum cable diameter strongly depends on the bending radius and the desired cable type. Please contact us.

Calculating the cable carrier length

Cable carrier length L_k

$$L_k \approx \frac{L_S}{2} + L_B$$

Cable carrier length L_k
rounded to pitch t

Number of glide shoes

$$\frac{\text{Pitch per cable carrier length}}{3} \times 2$$

h_i [mm]	h_G [mm]	h_G' [mm]	B_i [mm]*	B_k [mm]	B_{EF} [mm]	KR [mm]			q_k [kg/m]			
38	60	66	38 – 500	$B_i + 52$	$B_i + 56$	100	120	150	190	250	300	1.25 – 2.40

* in 1 mm width sections

Order example



Q060

Type

200

B_i [mm]

RS

Stay variant

150

KR [mm]

1540

L_k [mm]

HS

Stay arrangement

Divider systems

The divider system is mounted on each crossbar as a standard – on every 6th section for stay mounting (HS). As a standard, dividers or the complete divider system (dividers with height separations) are movable in the cross section (**version A**).

For applications with lateral acceleration and rotated by 90°, the dividers can be attached by simply clipping into a socket (available as an accessory). The socket additionally acts as a spacer between the dividers and is available in 1 mm sections between 3 – 50 mm (**version B**).

Divider system TS0 without height separation

Vers.	a _T min [mm]	a _x min [mm]	a _c min [mm]	n _T min
A	13.5	13	10	2

The dividers can be moved in the cross section.

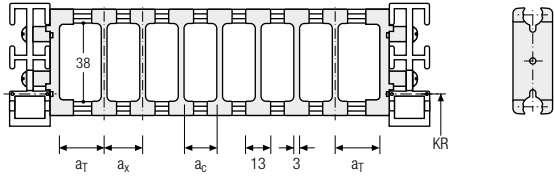

Divider system TS1 with continuous height separation

Vers.	a _T min [mm]	a _T max [mm]	a _x min [mm]	a _c min [mm]	n _T min
A	13.5	20	13	10	2

The dividers can be moved in the cross section.

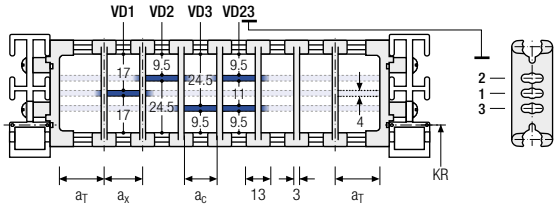

Divider system TS2 with partial height separation

Vers.	a _T min [mm]	a _x min [mm]	a _c min [mm]	n _T min
A	8.5	21	15	2

With grid distribution (1 mm grid). The dividers are attached by the height separation, the grid can be moved in the cross section.

Sliding dividers are optionally available (thickness of divider = 3 mm).

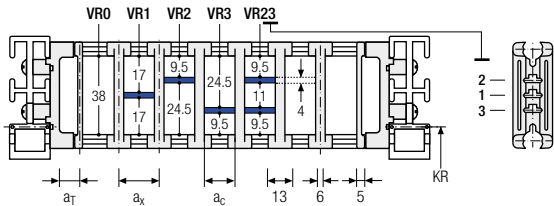

PROTUM® series
K series
UNIFLEX Advanced series
M series
XL series
QUANTUM® series
TKR series
TKA series
UAT series

Subject to change without notice.



TRAXLINE® cables for cable carriers

Hi-flex electric cables which were especially developed, optimized and tested for use in cable carriers can be found at tsubaki-kabelschlepp.com/traxline

Divider system TS3 with height separation consisting of plastic partitions

Vers.	a_T min [mm]	a_x min [mm]	a_c min [mm]	n_T min
A	11	16 / 42*	8	2

* For aluminum partitions

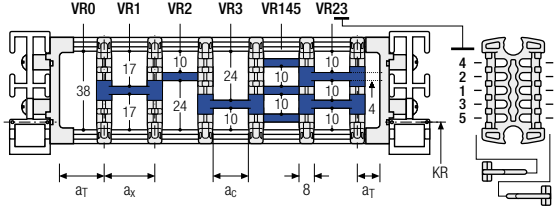

The dividers are fixed with the partitions.
The entire divider system can be moved
in the cross section.

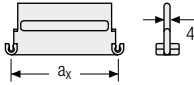

Aluminum partitions in
1 mm increments with
 $a_x > 42$ mm are also
available.

a_x (center distance of dividers) [mm]												
a_c (nominal width of inner chamber) [mm]												
16	18	23	28	32	33	38	43	48	58	64	68	
8	10	15	20	24	25	30	35	40	50	56	60	
78	80	88	96	112	128	144	160	176	192	208		
70	72	80	88	104	120	136	152	168	184	200		

When using **plastic partitions with $a_x > 112$ mm**, we recommend an additional center support with a **twin divider** ($S_T = 4$ mm). Twin dividers are also suitable for retrofitting in the partition system.

Order example

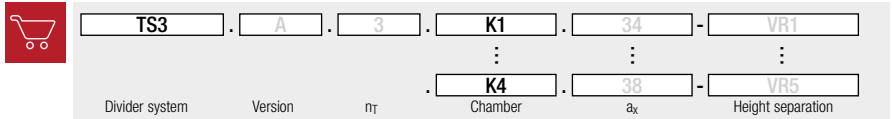

Please state the designation of the divider system (**TS0, TS1, ...**), the version, and the number of dividers per cross section [n_T]. In addition, please also enter the chambers [**K**] from left to right, as well as the assembly distances [a_T/a_x].

When using divider systems with height separation (**TS1 – TS3**), please additionally state the positions (e.g. VD23) viewed from the left driver belt. You are welcome to add a sketch to your order.

More product information online



Assembly instructions etc.:
Additional info via your
smartphone or check online at
[tsubaki-kabelschlepp.com/
downloads](https://tsubaki-kabelschlepp.com/downloads)



Configure your custom
cable carrier here:
online-engineer.de

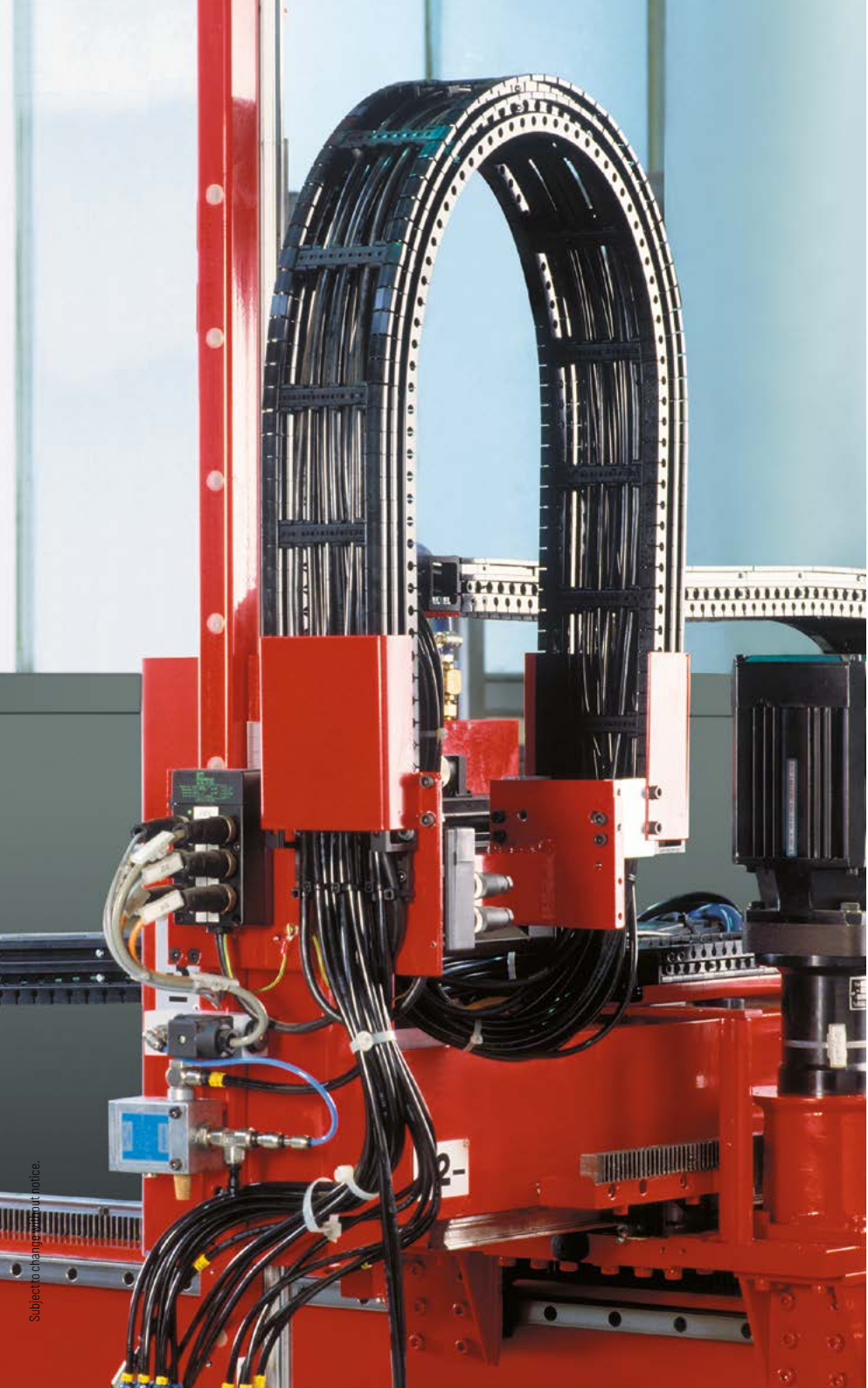

Subject to change without notice.

PROTUM®
series

K
series

UNIFLEX
Advanced
series

M
series

XL
series

QUANTUM®
series

TKR
series

TKA
series

UAT
series

Plastic stay RE – frame screw-in stay

- Plastic profile bars for light to medium loads.
Assembly without screws.
- Available customized in **8 mm sections**.
- **Outside/inside:** release by rotating 90°.



Stays on every 6th section,
standard (HS: half-stayed)



Stays on every 3rd section
(VS: fully-stayed)



8 mm B_i 68 – 276 mm in
8 mm width sections

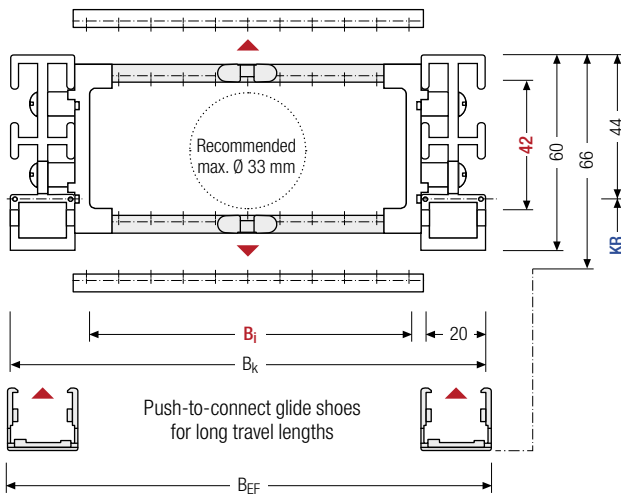

The maximum cable diameter strongly depends on the bending radius and the desired cable type. Please contact us.

Calculating the cable carrier length

Cable carrier length L_k

$$L_k \approx \frac{L_s}{2} + L_B$$

Cable carrier length L_k
rounded to pitch t

Number of glide shoes

$$\frac{\text{Pitch per cable carrier length}}{3} \times 2$$

h_i [mm]	h_g [mm]	$h_{g'}$ [mm]	B_i [mm]							B_k [mm]	B_{EF} [mm]	KR [mm]	q_k [kg/m]			
42	60	66	68	76	84	92	100	108	116	124	132	$B_i + 52$	$B_i + 56$	100	120	1.16
			140	148	156	164	172	180	188	196	204			150	190	–
			212	220	228	236	244	252	260	268	276			250	300	1.54

Order example



Q060

Type

196

B_i [mm]

RE

Stay variant

150

KR [mm]

1540

L_k [mm]

HS

Stay arrangement

Divider systems

The divider system is mounted on each crossbar as a standard – on every 6th section for stay mounting (HS). As a standard, dividers or the complete divider system (dividers with height separations) are movable in the cross section (**version A**).

For applications with lateral accelerations and applications with the cable carrier rotated by 90°, the dividers can easily be fixed by turning the frame stay by 180°. The arresting cams click into place in the locking grids in the crossbar (**version B**). The groove in the frame stay faces outwards.

Divider system TSO without height separation

Vers.	a _T min [mm]	a _x min [mm]	a _c min [mm]	a _x grid [mm]	π _T min
A	14	13	8.8	–	–
B	14	16	11.8	8	–

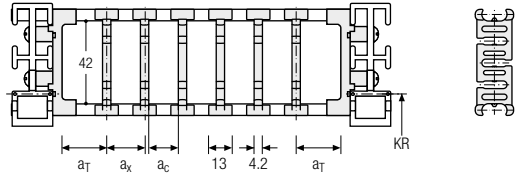

The dividers are movable within the cross section (version A) or fixed (version B).

Divider system TS1 with continuous height separation

Vers.	a _T min [mm]	a _T max [mm]	a _x min [mm]	a _c min [mm]	a _x Raster [mm]	π _T min
A	14	25	13	8.8	–	2

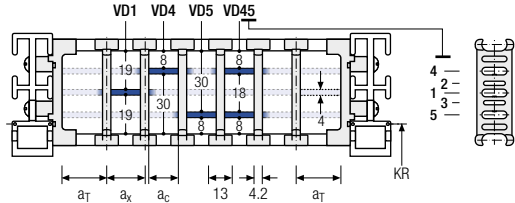

The dividers can be moved in the cross section.

PROTUM® series
K series
UNIFLEX Advanced series
M series
XL series
QUANTUM® series
TKR series
TKA series
UAT series

TOTALTRAX® complete systems



Benefit from the advantages of the TOTALTRAX® complete system. A complete delivery from one source – with a warranty certificate on request! Learn more at tsbaki-kabelschlepp.com/totaltrax

TRAXLINE® cables for cable carriers

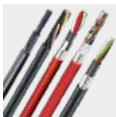

Hi-flex electric cables which were especially developed, optimized and tested for use in cable carriers can be found at tsbaki-kabelschlepp.com/traxline

Divider system TS3 with height separation consisting of plastic partitions

Vers.	a_T min [mm]	a_x min [mm]	a_c min [mm]	n_T min
A	11	16 / 42*	8	2

* For aluminum partitions

The dividers are fixed with the partitions.
The entire divider system can be moved in the cross section.

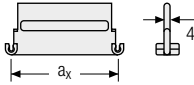
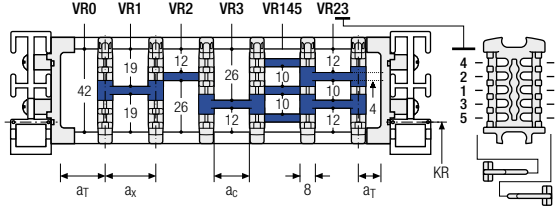

Aluminum partitions in 1 mm increments with $a_x > 42$ mm are also available.

a_x (center distance of dividers) [mm]											
a_c (nominal width of inner chamber) [mm]											
16	18	23	28	32	33	38	43	48	58	64	68
8	10	15	20	24	25	30	35	40	50	56	60
78	80	88	96	112	128	144	160	176	192	208	
70	72	80	88	104	120	136	152	168	184	200	

When using **plastic partitions with $a_x > 112$ mm**, we recommend an additional center support with a **twin divider** ($S_T = 4$ mm). Twin dividers are also suitable for retrofitting in the partition system. The height separations VR4 and VR5 are not possible when using twin dividers.

Order example



TS3	A	2	K1	16	VR1
			⋮	⋮	⋮
			K4	208	VR5
Divider system	Version	n_T	Chamber	a_x	Height separation

Please state the designation of the divider system (TS0, TS1,...), the version, and the number of dividers per cross section [n_T]. In addition, please also enter the chambers [K] from left to right, as well as the assembly distances [a_T/a_x].

When using divider systems with height separation (TS1 – TS3), please additionally state the positions (e.g. VD23) viewed from the left driver belt. You are welcome to add a sketch to your order.



TOTALTRAX® complete systems

Benefit from the advantages of the TOTALTRAX® complete system. A complete delivery from one source – with a warranty certificate on request! Learn more at tsubaki-kabelschlepp.com/totaltrax

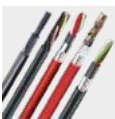

TRAXLINE® cables for cable carriers

Hi-flex electric cables which were especially developed, optimized and tested for use in cable carriers can be found at tsubaki-kabelschlepp.com/traxline

Universal end connectors UMB – plastic (standard)

The universal end connectors (UMB) are made from plastic and can be mounted from the top, from the bottom or face on.

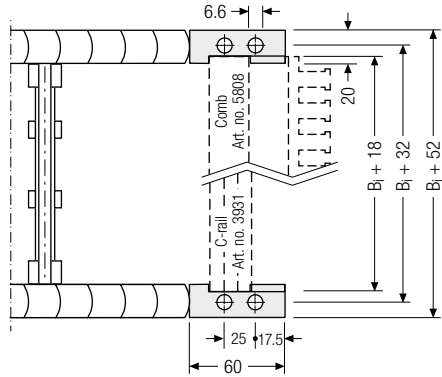
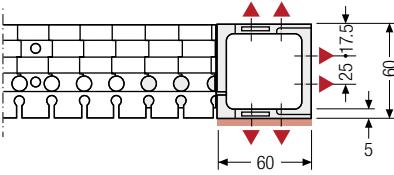

▲ Assembly options

Recommended tightening torque: 10 Nm

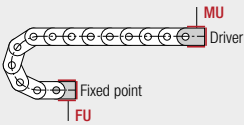

Connection point

F – fixed point
M – driver

Connection type

U – universal end connector

Order example

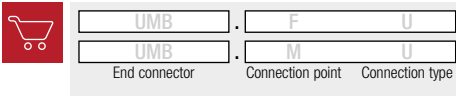

We recommend the use of strain reliefs at the driver and fixed point. See from p. 904.

More product information online



Assembly instructions etc.: Additional info via your smartphone or check online at tsubaki-kabelschlepp.com/downloads



Configure your custom cable carrier here: online-engineer.de

PROTUM® series
K series
UNIFLEX Advanced series
M series
XL series
QUANTUM® series
TKR series
TKA series
UAT series

Q080



Pitch
25 mm



Inner height
58 mm



Inner widths
50 – 600 mm



Bending radii
170 – 500 mm

Stay variants



Aluminum stay RS page 480

Frame stay, narrow "The standard"

- Aluminum profile bars for light to medium loads. Assembly without screws.
- **Outside/inside:** release by rotating 90°.



Aluminum stay RV page 484

Frame stay, reinforced

- Aluminum profile bars with plastic adapter for medium to high loads and large cable carrier widths. Assembly without screws.
- **Outside/inside:** release by rotating 90°.



Plastic stay RE page 488

Frame screw-in stay

- Plastic profile bars for light to medium loads. Assembly without screws.
- **Outside/inside:** release by rotating 90°.



TOTALTRAX® complete systems

Benefit from the advantages of the TOTALTRAX® complete system. A complete delivery from one source – with a warranty certificate on request! Learn more at tsubaki-kabelschlepp.com/totaltrax

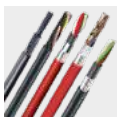

TRAXLINE® cables for cable carriers

Hi-flex electric cables which were especially developed, optimized and tested for use in cable carriers can be found at

tsubaki-kabelschlepp.com/traxline

Unsupported arrangement

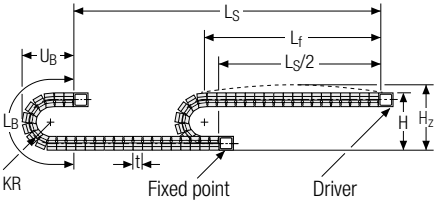

KR [mm]	H [mm]	L _B [mm]	U _B [mm]
170	457	834	379
200	517	928	409
250	617	1085	459
320	757	1305	529
420	957	1619	629
500	1117	1870	709

Load diagram for unsupported length depending on the additional load.

Sagging of the cable carrier is technically permitted for extended travel lengths, depending on the specific application.

Intrinsic cable carrier weight $q_k = 2.5 \text{ kg/m}$. For other inner widths, the maximum additional load changes.

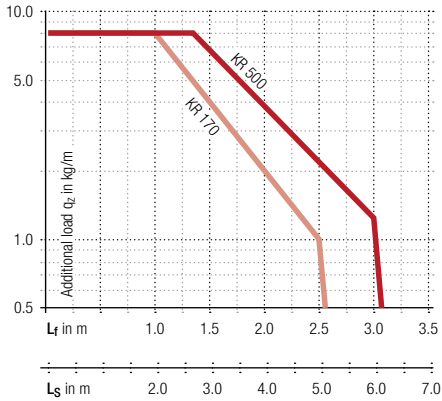

- Speed** up to 25 m/s
- Acceleration** up to 100 m/s²
- Travel length** up to 6.4 m
- Additional load** up to 8 kg/m

Gliding arrangement

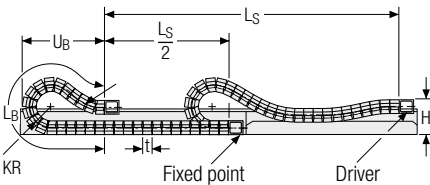

- Speed** up to 3 m/s
 - Acceleration** up to 2 – 3 m/s²
 - Travel length** up to 80 m
 - Additional load** up to 8 kg/m
- The gliding cable carrier has to be routed in a channel. See p. 844.
Glide shoes have to be used for gliding applications.

Our technical support can provide help for gliding arrangements: technik@kabelschlepp.de

Subject to change without notice.

PROTUM® series
K series
UNIFLEX Advanced series
M series
XL series
QUANTUM® series
TKR series
TKA series
UAT series

Aluminum stay RS – frame stay narrow

- Extremely quick to open and close
- Aluminum profile bars for light to medium loads.
Assembly without screws.
- Available customized in **1 mm sections**.
- Outside/inside:** release by rotating 90°.

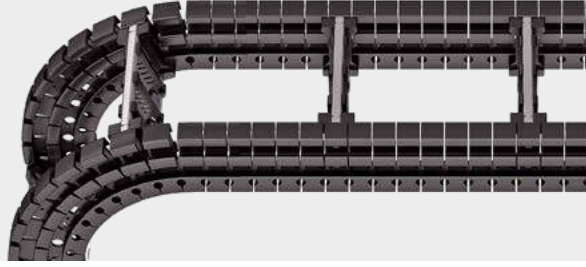

Stays on every 8th section.
standard (HS: half-stayed)



Stays on every 4th section
(VS: fully-stayed)



1 mm B_i 50 – 600 mm in
1 mm width sections

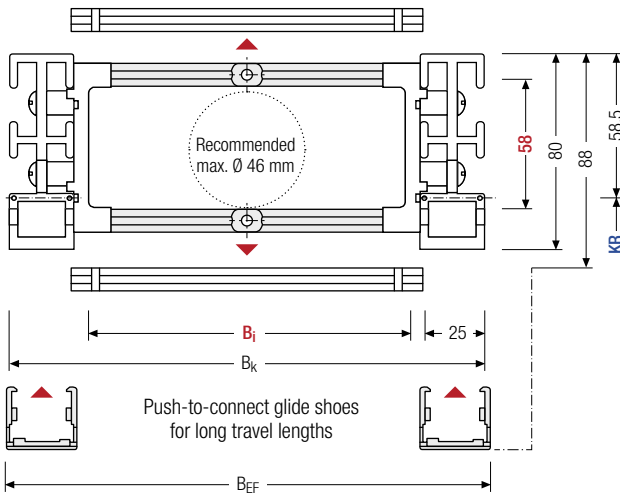

The maximum cable diameter strongly depends on the bending radius and the desired cable type. Please contact us.

Calculating the cable carrier length

Cable carrier length L_k

$$L_k \approx \frac{L_S}{2} + L_B$$

Cable carrier length L_k
rounded to pitch t

Number of glide shoes

$$\frac{\text{Pitch per cable carrier length}}{4} \times 2 - 2$$

h_i [mm]	h_g [mm]	h_g' [mm]	B_i [mm]*	B_k [mm]	B_{EF} [mm]	KR [mm]				q_k [kg/m]		
58	80	88	50 – 600	$B_i + 72$	$B_i + 79.5$	170	200	250	320	420	500	1.90 – 2.25

* in 1 mm width sections

Order example



Q080

Type

400

B_i [mm]

RS

Stay variant

250

KR [mm]

1600

L_k [mm]

HS

Stay arrangement

Divider systems

The divider system is mounted on each crossbar as a standard – on every 8th section for stay mounting (HS). As a standard, dividers or the complete divider system (dividers with height separations) are movable in the cross section (**version A**).

For applications with lateral acceleration and rotated by 90°. the dividers can be attached by simply clipping onto a socket (available as an accessory).

This socket additionally acts as a spacer between the dividers and is available in a 1 mm grid between 3 – 50 mm, as well as 16.5 and 21.5 mm (**version B**).

Divider system TS0 without height separation

Vers.	a _T min [mm]	a _x min [mm]	a _c min [mm]	π _T min
A	11	14	10	2

The dividers can be moved in the cross section.

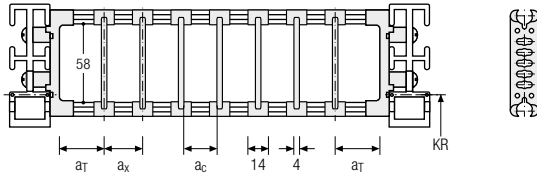

Divider system TS1 with continuous height separation

Vers.	a _T min [mm]	a _T max [mm]	a _x min [mm]	a _c min [mm]	π _T min
A	11	25	14	10	2

The dividers can be moved in the cross section.

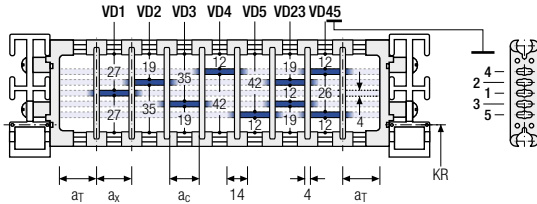

Divider system TS2 with partial height separation

Vers.	a _T min [mm]	a _x min [mm]	a _c min [mm]	π _T min
A	11	23	19	2

With grid distribution (1 mm grid). The dividers are attached by the height separation, the grid can be moved in the cross section.

Sliding dividers are optionally available (thickness of divider = 4 mm).

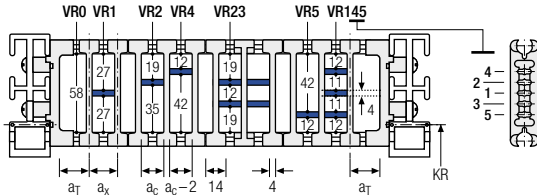

Please note that the real dimensions may deviate slightly from the values indicated here.

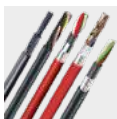

TRAXLINE® cables for cable carriers

Hi-flex electric cables which were especially developed, optimized and tested for use in cable carriers can be found at tsubaki-kabelschlepp.com/traxline

PROTUM® series
K series
UNIFLEX Advanced series
M series
XL series
QUANTUM® series
TKR series
TKA series
UAT series

Divider system TS3 with height separation consisting of plastic partitions

As a standard, the divider **version A** is used for vertical partitioning within the cable carrier. The complete divider system can be moved within the cross section.

PROTUM® series

K series

Divider version A

End divider

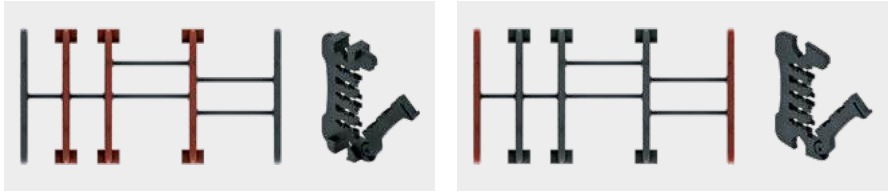

UNIFLEX Advanced series

M series

Vers.	a _T min [mm]	a _x min [mm]	a _c min [mm]	n _T min
A	10.5 / 6.5*	14	10	2

* For End divider

The dividers are fixed by the partitions. the complete divider system is movable in the cross section.

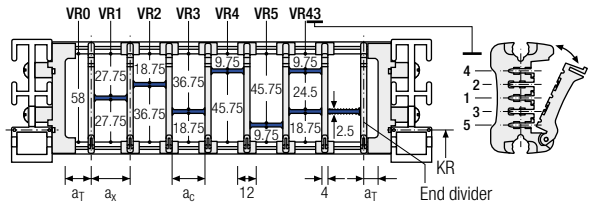

XL series

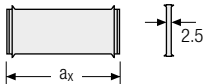

a _x (center distance of dividers) [mm]																
a _c (nominal width of inner chamber) [mm]																
14	16	19	23	24	28	29	32	33	34	38	39	43	44	48	49	54
10	12	15	19	20	24	25	28	29	30	34	35	39	40	44	45	50
58	59	64	68	69	74	78	79	80	84	88	89	94	96	99	112	
54	55	60	64	65	70	74	75	76	80	84	85	90	92	95	108	

When using partitions with a_x > 49 mm we recommended an additional preferential central support.

QUANTUM® series

TKR series

Order example

TS3 .
 A .
 3 .
 K1 .
 34 -
 VR1
 ⋮
 ⋮
 ⋮
K4 .
 38 -
 VR3

Divider system
Version
n_T
Chamber
a_x
Height separation

TKA series

Please state the designation of the divider system (TS0, TS1...), version and number of dividers per cross section [n_T]. In addition, please also enter the chambers [K] from left to right, as well as the assembly distances [a_T/a_x] (as seen from the driver).

If using divider systems with height separation (TS1, TS3) please also state the positions [e.g. VD23] viewed from the left driver belt. You are welcome to add a sketch to your order.

UAT series



Subject to change without notice.

UAT
series

TKA
series

TKR
series

QUANTUM®
series

XL
series

M
series

UNIFLEX
Advanced
series

K
series

PROTUM®
series

Aluminum stay RV – Frame stay reinforced

- Aluminum profile bars with plastic adapter for medium to high loads and large cable carrier widths. Assembly without screws.
- Available customized in **1 mm sections**.
- **Outside/inside:** release by rotating 90°.

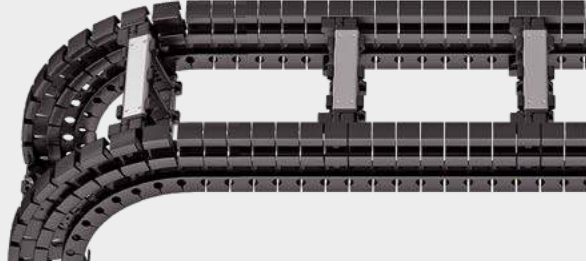

Stays on every 8th section.
standard (HS: half-stayed)



Stays on every 4th section
(VS: fully-stayed)



1 mm B_i 50 – 600 mm in
1 mm width sections

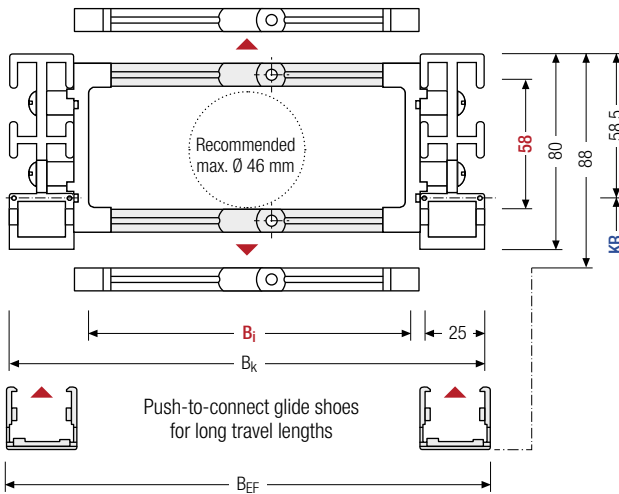

The maximum cable diameter strongly depends on the bending radius and the desired cable type. Please contact us.

Calculating the cable carrier length

Cable carrier length L_k

$$L_k \approx \frac{L_S}{2} + L_B$$

Cable carrier length L_k rounded to pitch t

Number of glide shoes

$$\frac{\text{Pitch per cable carrier length}}{4} \times 2 - 2$$

h_i [mm]	h_G [mm]	h_G' [mm]	B_i [mm]*	B_k [mm]	B_{EF} [mm]	KR [mm]		q_k [kg/m]
58	80	88	50 – 600	$B_i + 72$	$B_i + 79.5$	170	200 250 320 420 500	2.10 – 2.90

* in 1 mm width sections

Order example



Q080

Type

400

B_i [mm]

RV

Stay variant

250

KR [mm]

1600

L_k [mm]

HS

Stay arrangement

Divider systems

The divider system is mounted on each crossbar as a standard – on every 8th section for stay mounting (HS).

As a standard, dividers or the complete divider system (dividers with height separations) are movable in the cross section (**version A**).

Divider system TS0 without height separation

Vers.	a _T min [mm]	a _x min [mm]	a _c min [mm]	n _T min
A	11	14	10	2

The dividers can be moved in the cross section.

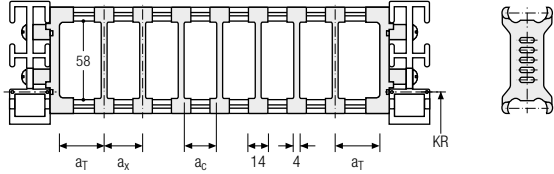

Divider system TS1 with continuous height separation

Vers.	a _T min [mm]	a _T max [mm]	a _x min [mm]	a _c min [mm]	n _T min
A	11	25	14	10	2

The dividers can be moved in the cross section.

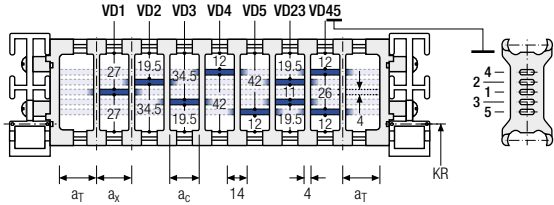

Divider system TS2 with partial height separation

Vers.	a _T min [mm]	a _x min [mm]	a _c min [mm]	n _T min
A	12	21	15	2

With grid distribution (1 mm grid). The dividers are attached by the height separation, the grid can be moved in the cross section.

Sliding dividers are optionally available (thickness of divider = 4 mm).

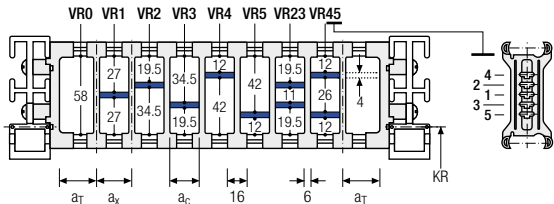

PROTUM® series
K series
UNIFLEX Advanced series
M series
XL series
QUANTUM® series
TKR series
TKA series
UAT series



TRAXLINE® cables for cable carriers

Hi-flex electric cables which were especially developed, optimized and tested for use in cable carriers can be found at tsubaki-ka-belschlepp.com/traxline

Divider system TS3 with height separation consisting of plastic partitions

Vers.	a_T min [mm]	a_x min [mm]	a_c min [mm]	n_T min
A	8	16 / 42*	8	2

* For aluminum partitions

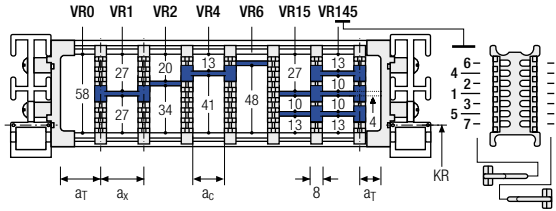

The dividers are fixed with the partitions.
The entire divider system can be moved in the cross section.

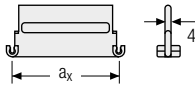

Aluminum partitions in 1 mm increments with $a_x > 42$ mm are also available.

a_x (center distance of dividers) [mm]											
a_c (nominal width of inner chamber) [mm]											
16	18	23	28	32	33	38	43	48	58	64	68
8	10	15	20	24	25	30	35	40	50	56	60
78	80	88	96	112	128	144	160	176	192	208	
70	72	80	88	104	120	136	152	168	184	200	

When using **plastic partitions with $a_x > 112$ mm**, we recommend an additional center support with a **twin divider** ($S_T = 4$ mm). Twin dividers are also suitable for retrofitting in the partition system. The height separations VR6 and VR7 are not possible when using twin dividers.

Order example



TS3	A	3	K1	16	VR1
			⋮	⋮	⋮
			K4	208	VR7
Divider system	Version	n_T	Chamber	a_x	Height separation

Please state the designation of the divider system (**TS0, TS1, ...**), the version, and the number of dividers per cross section [n_T]. In addition, please also enter the chambers [K] from left to right, as well as the assembly distances [a_T/a_x].

When using divider systems with height separation (**TS1 – TS3**), please additionally state the positions (e.g. VD23) viewed from the left driver belt. You are welcome to add a sketch to your order.

More product information online



Assembly instructions etc.:
Additional info via your
smartphone or check online at
[tsubaki-kabelschlepp.com/
downloads](https://tsubaki-kabelschlepp.com/downloads)



Configure your custom
cable carrier here:
online-engineer.de



Subject to change without notice.

PROTUM®
series

K
series

UNIFLEX
Advanced
series

M
series

XL
series

QUANTUM®
series

TKR
series

TKA
series

UAT
series

Plastic stay RE – frame screw-in stay

- Plastic profile bars for light to medium loads.
Assembly without screws.
- Available customized in **16 mm sections**.
- **Outside/inside:** release by rotating 90°.

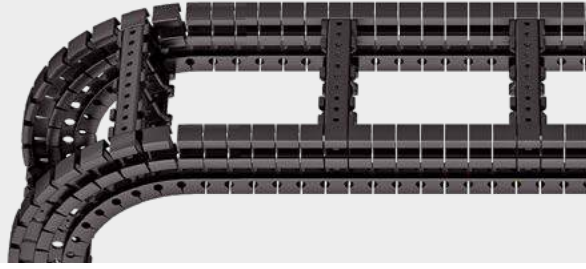

Stays on every 8th section.
standard (HS: half-stayed)



Stays on every 4th section
(VS: fully-stayed)



8 mm B_i 58 – 570 mm in
16 mm width sections

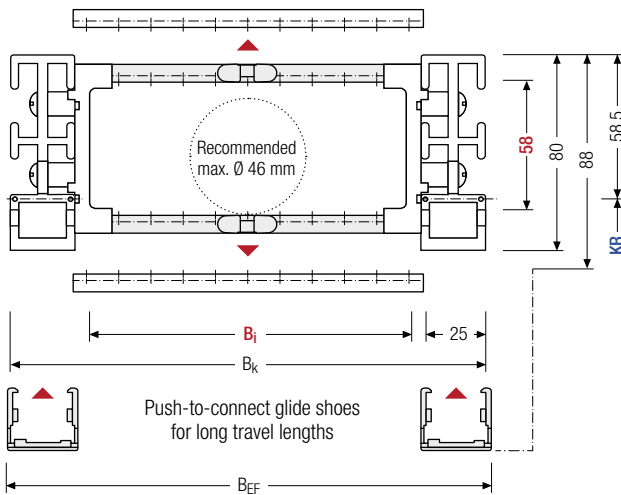

The maximum cable diameter strongly depends on the bending radius and the desired cable type. Please contact us.

Calculating the cable carrier length

Cable carrier length L_k

$$L_k \approx \frac{L_S}{2} + L_B$$

Cable carrier length L_k
rounded to pitch t

Number of glide shoes

$$\frac{\text{Pitch per cable carrier length}}{4} \times 2 - 2$$

h_i [mm]	h_g [mm]	$h_{g'}$ [mm]	B_i [mm]										B_k [mm]	B_{EF} [mm]	KR [mm]	q_k [kg/m]	
58	80	88	58	74	90	106	122	138	154	170	186	$B_i + 72$	$B_i + 79.5$	170	200	1.93	
			202	218	234	250	266	282	298	314	330			250	320		
			346	362	378	394	410	426	442	458	474			420	500		2.70
			490	506	522	538	554	570									

Order example



Q080

Type

196

B_i [mm]

RE

Stay variant

250

KR [mm]

1600

L_k [mm]

HS

Stay arrangement

Divider systems

The divider system is mounted on each crossbar as a standard – on every 8th section for stay mounting (HS). As a standard, dividers or the complete divider system (dividers with height separations) are movable in the cross section (**version A**).

For applications with lateral accelerations and applications with the cable carrier rotated by 90°, the dividers can easily be fixed by turning the frame stay by 180°. The arresting cams click into place in the locking grids in the crossbar (**version B**). The groove in the frame stay faces outwards.

Divider system TS0 without height separation

Vers.	a _T min [mm]	a _x min [mm]	a _c min [mm]	a _x grid [mm]	π _T min
A	12	14.5	8.5	–	–
B	13	16	10	16	–

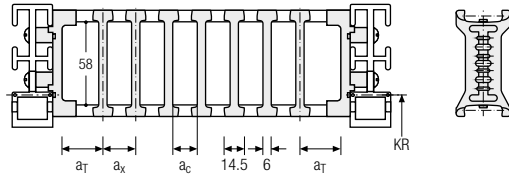

The dividers are movable within the cross section (version A) or fixed (version B).

Divider system TS1 with continuous height separation

Vers.	a _T min [mm]	a _T max [mm]	a _x min [mm]	a _c min [mm]	a _x Raster [grid]	π _T min
A	12	25	14.5	8.5	–	2
B	13	25	16	10	16	2

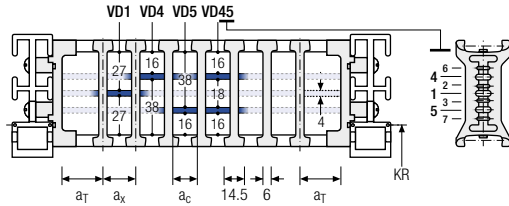

The dividers are movable within the cross section (version A) or fixed (version B).

Divider system TS2 with partial height separation

Vers.	a _T min [mm]	a _x min [mm]	a _c min [mm]	π _T min
A	12	14.5*/21	8.5*/15	2
B	13	16*/32	10*/26	2

* for VR0

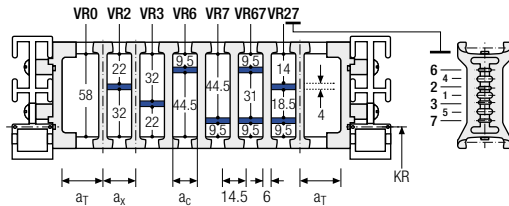

With grid distribution (8 mm grid). The dividers are attached by the height separation. the grid can be moved in the cross section (version A) or fixed (version B).

PROTUM® series
K series
UNIFLEX Advanced series
M series
XL series
QUANTUM® series
TKR series
TKA series
UAT series



TOTALTRAX® complete systems

Benefit from the advantages of the TOTALTRAX® complete system. A complete delivery from one source – with a warranty certificate on request! Learn more at tsubaki-kabelschlepp.com/totaltrax

Divider system TS3 with height separation consisting of plastic partitions

Vers.	a _T min [mm]	a _x min [mm]	a _c min [mm]	n _T min
A	8	16 / 42*	8	2

* For aluminum partitions

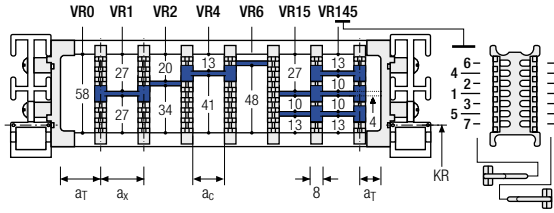

The dividers are fixed with the partitions. The entire divider system can be moved in the cross section.

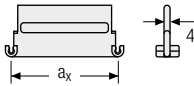

Aluminum partitions in 1 mm increments with **a_x > 42 mm** are also available.

a _x (center distance of dividers) [mm]											
a _c (nominal width of inner chamber) [mm]											
16	18	23	28	32	33	38	43	48	58	64	68
8	10	15	20	24	25	30	35	40	50	56	60
78	80	88	96	112	128	144	160	176	192	208	
70	72	80	88	104	120	136	152	168	184	200	

When using **plastic partitions with a_x > 112 mm**, we recommend an additional center support with a **twin divider** (S_T = 4 mm). Twin dividers are also suitable for retrofitting in the partition system.

Order example

TS3	.	A	.	2	.	K1	.	16	-	VR1
⋮		⋮		⋮		⋮		⋮		⋮
K4	.	208	-	VR5						
Divider system		Version		n _T		Chamber		a _x		Height separation

Please state the designation of the divider system (**TS0, TS1,...**), the version, and the number of dividers per cross section [n_T]. In addition, please also enter the chambers [K] from left to right, as well as the assembly distances [a_T/a_x].

When using divider systems with height separation (**TS1 – TS3**), please additionally state the positions (e.g. VD23) viewed from the left driver belt. You are welcome to add a sketch to your order.



TOTALTRAX® complete systems

Benefit from the advantages of the TOTALTRAX® complete system. A complete delivery from one source – with a warranty certificate on request! Learn more at tsubaki-kabelschlepp.com/totaltrax

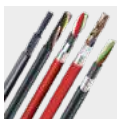

TRAXLINE® cables for cable carriers

Hi-flex electric cables which were especially developed, optimized and tested for use in cable carriers can be found at tsubaki-kabelschlepp.com/traxline

Universal end connectors UMB – plastic (standard)

The universal end connectors (UMB) are made from plastic and can be mounted from the top, from the bottom or face on.

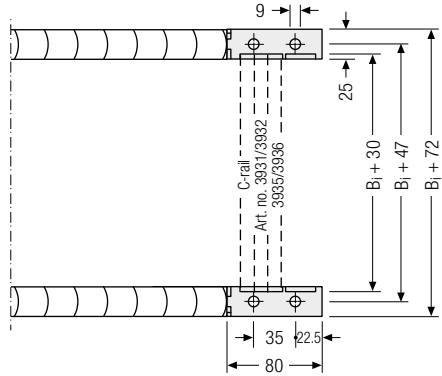
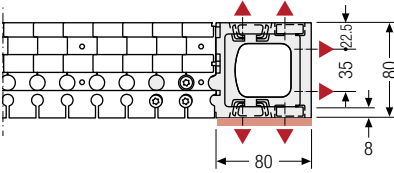

▲ Assembly options

 Recommended tightening torque:
 30 Nm for screws M8 - 8.8
 18 Nm for screws M8 - 12.9

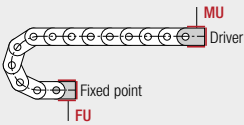

Connection point

F – fixed point
M – driver

Connection type

U – universal end connector

Order example

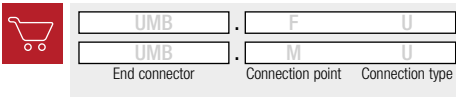

 We recommend the use of strain reliefs at the driver and fixed point. See from p. 904.

More product information online



Assembly instructions etc.:
 Additional info via your smartphone or check online at tsubaki-kabelschlepp.com/downloads



Configure your custom cable carrier here:
online-engineer.de

PROTUM® series
K series
UNIFLEX Advanced series
M series
XL series
QUANTUM® series
TKR series
TKA series
UAT series

Q100



Pitch
30 mm



Inner height
72 mm



Inner widths
70 – 600 mm



Bending radii
180 – 600 mm

Stay variants

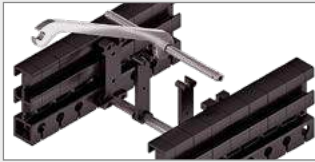

Aluminum stay RS page 494

Frame stay narrow "The standard"

- Aluminum profile bars for light to medium loads. Assembly without screws.
- **Outside/inside:** release by rotating 90°.

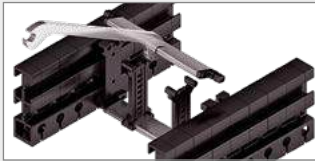

Aluminum stay RV page 498

Frame stay, reinforced

- Aluminum profile bars with plastic adapter for medium to high loads and large cable carrier widths. Assembly without screws.
- **Outside/inside:** release by rotating 90°.



Plastic stay RE page 502

Frame screw-in stay

- Plastic profile bars for light to medium loads. Assembly without screws.
- **Outside/inside:** release by rotating 90°.



TOTALTRAX® complete systems

Benefit from the advantages of the TOTALTRAX® complete system. A complete delivery from one source – with a warranty certificate on request! Learn more at tsubaki-kabelschlepp.com/totaltrax



TRAXLINE® cables for cable carriers

Hi-flex electric cables which were especially developed, optimized and tested for use in cable carriers can be found at tsubaki-kabelschlepp.com/traxline

Unsupported arrangement

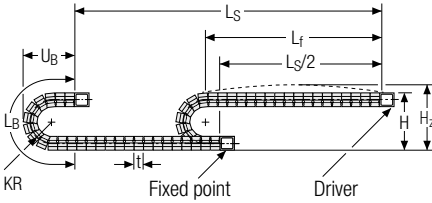

KR [mm]	H [mm]	L _B [mm]	U _B [mm]
180	503	926	432
250	643	1145	502
300	743	1302	552
370	883	1522	622
460	1063	1805	712
600	1343	2244	852

Load diagram for unsupported length depending on the additional load.

Sagging of the cable carrier is technically permitted for extended travel lengths, depending on the specific application.

Intrinsic cable carrier weight $q_k = 3.25 \text{ kg/m}$. For other inner widths, the maximum additional load changes.

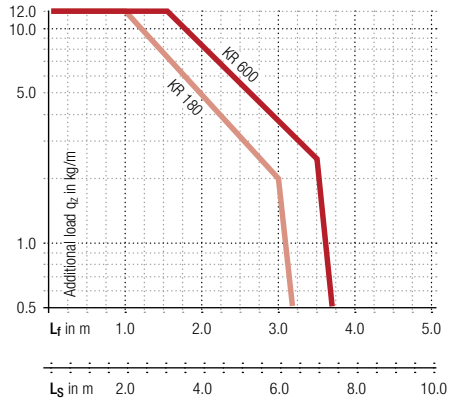

- Speed** up to 20 m/s
- Acceleration** up to 70 m/s²
- Travel length** up to 7.8 m
- Additional load** up to 12 kg/m

Gliding arrangement

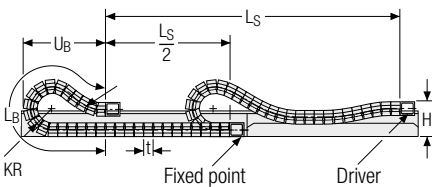

- Speed** up to 3 m/s
 - Acceleration** up to 2 – 3 m/s²
 - Travel length** up to 95 m
 - Additional load** up to 12 kg/m
- The gliding cable carrier has to be routed in a channel. See p. 844.
Glide shoes have to be used for gliding applications.

Our technical support can provide help for gliding arrangements: technik@kabelschlepp.de

Aluminum stay RS – frame stay narrow

- Extremely quick to open and close.
- Aluminum profile bars for light to medium loads.
Assembly without screws.
- Available customized in **1 mm sections**.
- Outside/inside:** release by rotating 90°.



Stays on every 8th section,
standard (HS: half-stayed)



Stays on every 4th section
(VS: fully-stayed)



1 mm B_i 70 – 600 mm in
1 mm width sections

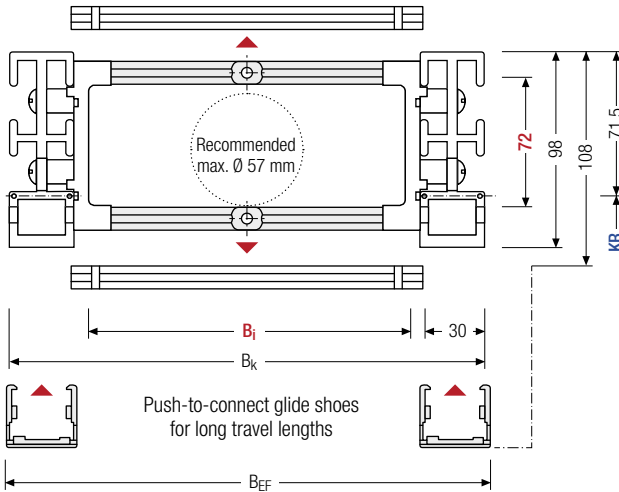

The maximum cable diameter strongly depends on the bending radius and the desired cable type. Please contact us.

Calculating the cable carrier length

Cable carrier length L_k

$$L_k \approx \frac{L_S}{2} + L_B$$

Cable carrier length L_k
rounded to pitch t

Number of glide shoes

$$\frac{\text{Pitch per cable carrier length}}{4} \times 2 - 2$$

h_i [mm]	h_G [mm]	h_G' [mm]	B_i [mm]*	B_k [mm]	B_{EF} [mm]	KR [mm]		q_k [kg/m]
72	98	108	70 – 600	$B_i + 82$	$B_i + 89.5$	180	250 300 370 460 600	2.6 – 3.4

* in 1 mm width sections

Order example



Q100

Type

400

B_i [mm]

RS

Stay variant

370

KR [mm]

1860

L_k [mm]

HS

Stay arrangement

Divider systems

The divider system is mounted on each crossbar as a standard – on every 8th section for stay mounting (HS). As a standard, dividers or the complete divider system (dividers with height separations) are movable in the cross section (**version A**).

For applications with lateral acceleration and rotated by 90°, the dividers can be attached by simply clipping into a socket (available as an accessory). The socket additionally acts as a spacer between the dividers and is available in 1 mm sections between 3 – 50 mm (**version B**).

Divider system TSO without height separation

Vers.	a _T min [mm]	a _x min [mm]	a _c min [mm]	n _T min
A	11	15	10	2

The dividers can be moved in the cross section.

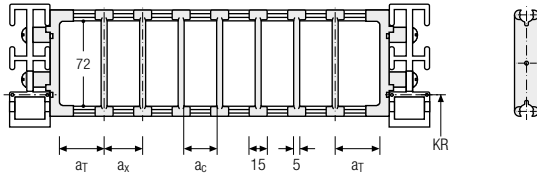

Divider system TS1 with continuous height separation

Vers.	a _T min [mm]	a _T max [mm]	a _x min [mm]	a _c min [mm]	n _T min
A	11	25	15	10	2

The dividers can be moved in the cross section.

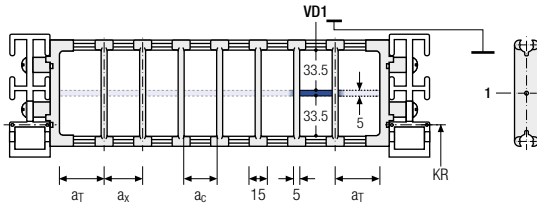

Order example

TS1

A

3

VD1

-

VD1

⋮

VD3

-

Divider system

Version

n_T

Height separation

Please state the designation of the divider system (TS0, TS1,...), the version, and the number of dividers per cross section [n_T].

When using divider systems with height separation (TS1), please additionally state the positions (e.g. VD1) viewed from the left driver belt. You are welcome to add a sketch to your order.

PROTUM® series
K series
UNIFLEX Advanced series
M series
XL series
QUANTUM® series
TKR series
TKA series
UAT series

Divider system TS3 with height separation consisting of plastic partitions

As a standard, the divider **version A** is used for vertical partitioning within the cable carrier. The complete divider system can be moved within the cross section.

PROTUM® series

K series

Divider version A

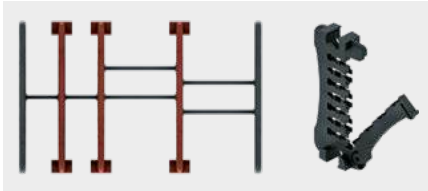

End divider

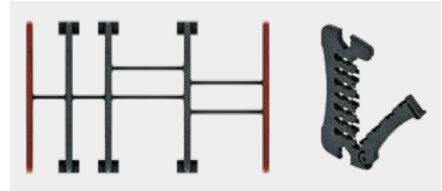

UNIFLEX Advanced series

M series

Vers.	a_T min [mm]	a_x min [mm]	a_c min [mm]	n_T min
A	10.5 / 6.5	14	10	2

* For End divider

The dividers are fixed by the partitions, the complete divider system is movable in the cross section.

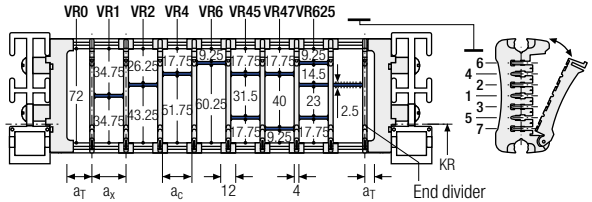

XL series

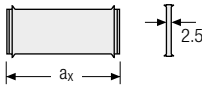

a_x (center distance of dividers) [mm]																
a_c (nominal width of inner chamber) [mm]																
14	16	19	23	24	28	29	32	33	34	38	39	43	44	48	49	54
10	12	15	19	20	24	25	28	29	30	34	35	39	40	44	45	50
58	59	64	68	69	74	78	79	80	84	88	89	94	96	99	112	
54	55	60	64	65	70	74	75	76	80	84	85	90	92	95	108	

When using partitions with $a_x > 49$ mm we recommended an additional preferential central support.

QUANTUM® series

Order example

TS3

A

3

K1

34

VR1

K4

38

VR3

Divider system
Version
 n_T
Chamber
 a_x
Height separation

TKR series

TKA series

UAT series

Please state the designation of the divider system (TS0, TS1,...), version and number of dividers per cross section n_T . In addition, please also enter the chambers [K] from left to right, as well as the assembly distances $[a_T/a_x]$ (as seen from the driver).

If using divider systems with height separation (TS1, TS3) please also state the positions [e.g. VD23] viewed from the left driver belt. You are welcome to add a sketch to your order.

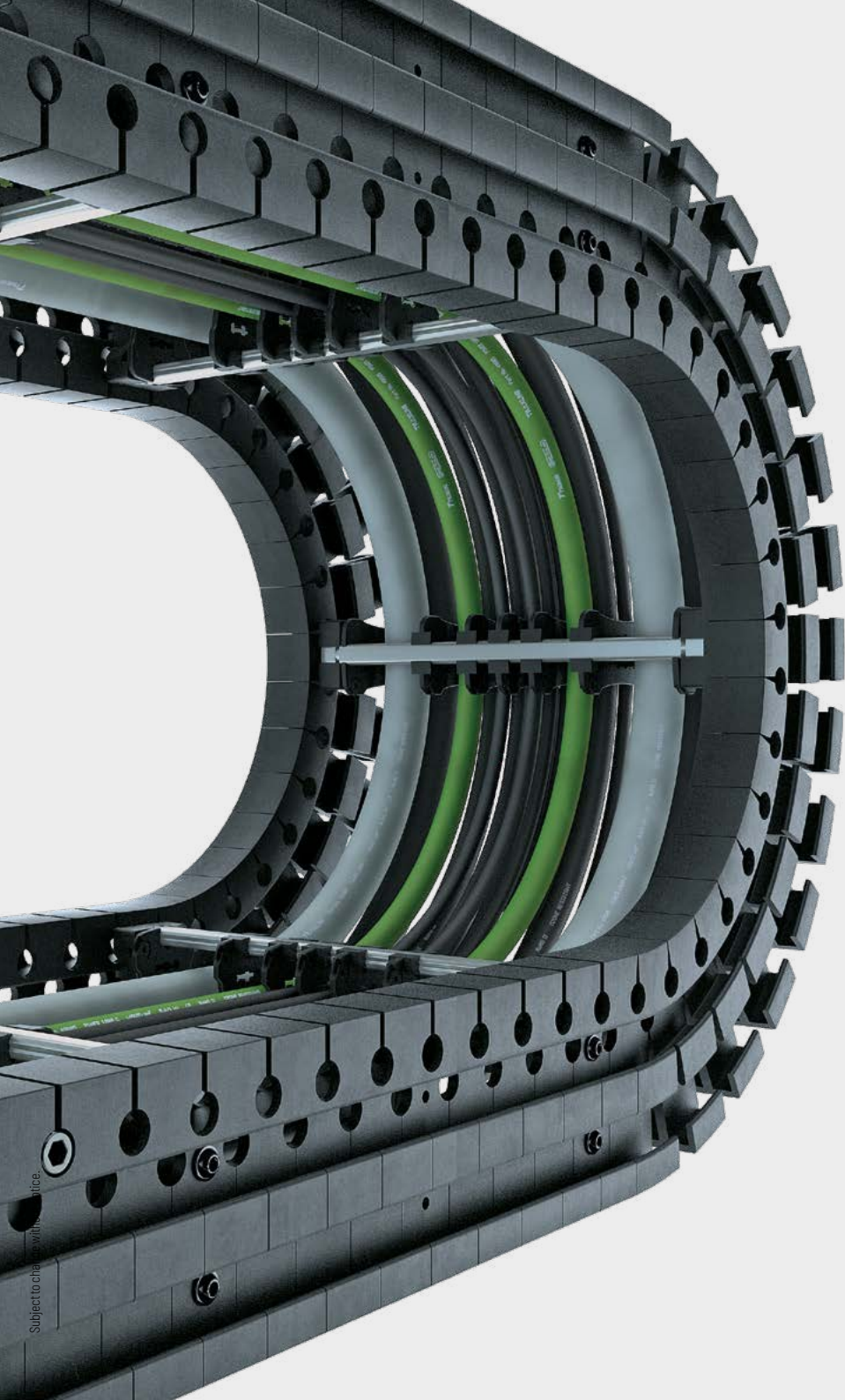

Subject to check with the price.

PROTUM®
series

K
series

UNIFLEX
Advanced
series

M
series

XL
series

QUANTUM®
series

TKR
series

TKA
series

UAT
series

Aluminum stay RV – Frame stay reinforced

- Aluminum profile bars with plastic adapter for medium to high loads and large cable carrier widths. Assembly without screws.
- Available customized in **1 mm sections**.
- **Outside/inside:** release by rotating 90°.



Stays on every 8th section,
standard (HS: half-stayed)



Stays on every 4th section
(VS: fully-stayed)



1 mm B_i 70 – 600 mm in
1 mm width sections

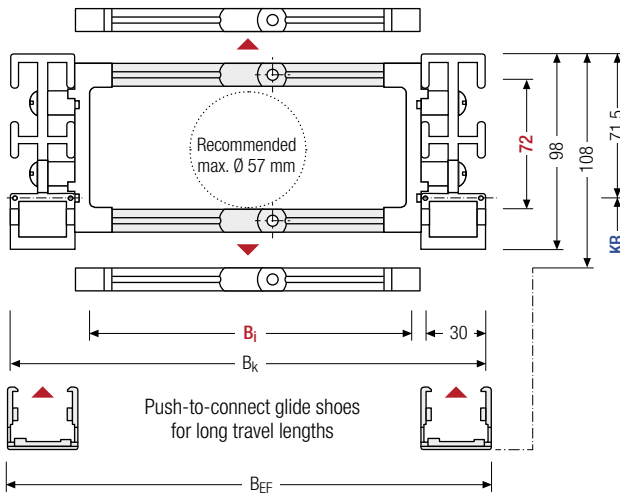

The maximum cable diameter strongly depends on the bending radius and the desired cable type. Please contact us.

Calculating the cable carrier length

Cable carrier length L_k

$$L_k \approx \frac{L_S}{2} + L_B$$

Cable carrier length L_k rounded to pitch t

Number of glide shoes

$$\frac{\text{Pitch per cable carrier length}}{4} \times 2 - 2$$

h _i [mm]	h _G [mm]	h _{G'} [mm]	B _i [mm]*	B _k [mm]	B _{EF} [mm]	KR [mm]		q _k [kg/m]
72	98	108	70 – 600	B _i + 82	B _i + 89.5	180	250 300 370 460 600	2.8 – 4.6

* in 1 mm width sections

Order example



Q100

Type

400

B_i [mm]

RV

Stay variant

370

KR [mm]

1860

L_k [mm]

HS

Stay arrangement

Divider systems

The divider system is mounted on each crossbar as a standard – on every 8th section for stay mounting (HS).

As a standard, dividers or the complete divider system (dividers with height separations) are movable in the cross section (**version A**).

Divider system TSO without height separation

Vers.	a _T min [mm]	a _x min [mm]	a _c min [mm]	n _T min
A	13	16	10	2

The dividers can be moved in the cross section.

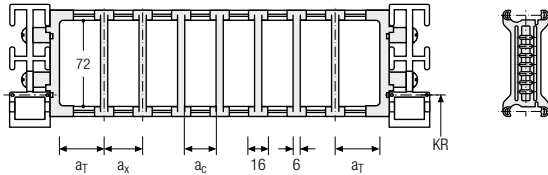

Divider system TS1 with continuous height separation

Vers.	a _T min [mm]	a _T max [mm]	a _x min [mm]	a _c min [mm]	n _T min
A	13	25	16	10	2

The dividers can be moved in the cross section.

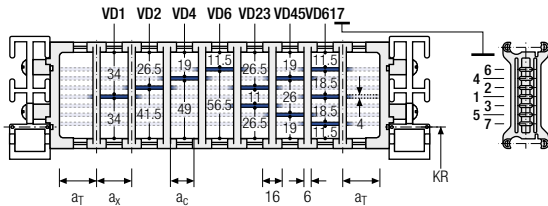

Divider system TS2 with partial height separation

Vers.	a _T min [mm]	a _x min [mm]	a _c min [mm]	n _T min
A	13	21	15	2

With grid distribution (1 mm grid). The dividers are attached by the height separation, the grid can be moved in the cross section.

Sliding dividers are optionally available (thickness of divider = 6 mm).

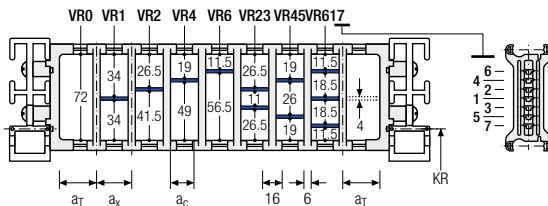

PROTUM® series
K series
UNIFLEX Advanced series
M series
XL series
QUANTUM® series
TKR series
TKA series
UAT series

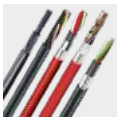

TRAXLINE® cables for cable carriers

Hi-flex electric cables which were especially developed, optimized and tested for use in cable carriers can be found at tsubaki-kabelschlepp.com/traxline

Divider system TS3 with height separation consisting of plastic partitions

Vers.	a_T min [mm]	a_x min [mm]	a_c min [mm]	n_T min
A	8	16/42*	8	2

* For aluminum partitions

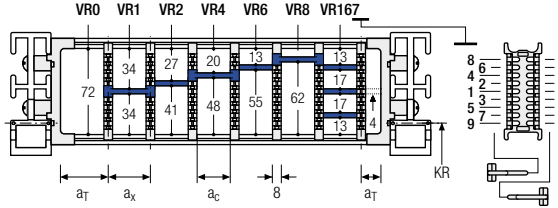

The dividers are fixed with the partitions. The entire divider system can be moved in the cross section.

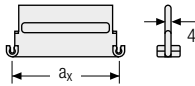

Aluminum partitions in 1 mm increments with $a_x > 42$ mm are also available.

a_x (center distance of dividers) [mm]											
a_c (nominal width of inner chamber) [mm]											
16	18	23	28	32	33	38	43	48	58	64	68
8	10	15	20	24	25	30	35	40	50	56	60
78	80	88	96	112	128	144	160	176	192	208	
70	72	80	88	104	120	136	152	168	184	200	

When using **plastic partitions with $a_x > 112$ mm**, we recommend an additional center support with a **twin divider** ($S_T = 4$ mm). Twin dividers are also suitable for retrofitting in the partition system. The height separations VR8 and VR9 are not possible when using twin dividers.

Order example

TS3

A

3

K1

16

VR1

⋮
 ⋮
 ⋮

K4

208

VR9

Divider system
Version
 n_T
Chamber
 a_x
Height separation

Please state the designation of the divider system (**TS0, TS1, ...**), the version, and the number of dividers per cross section [n_T]. In addition, please also enter the chambers [K] from left to right, as well as the assembly distances [a_T/a_x].

When using divider systems with height separation (**TS1 – TS3**), please additionally state the positions (e.g. VD23) viewed from the left driver belt. You are welcome to add a sketch to your order.

More product information online



Assembly instructions etc.:
Additional info via your
smartphone or check online at
[tsubaki-kabelschlepp.com/
downloads](https://tsubaki-kabelschlepp.com/downloads)



Configure your custom
cable carrier here:
online-engineer.de

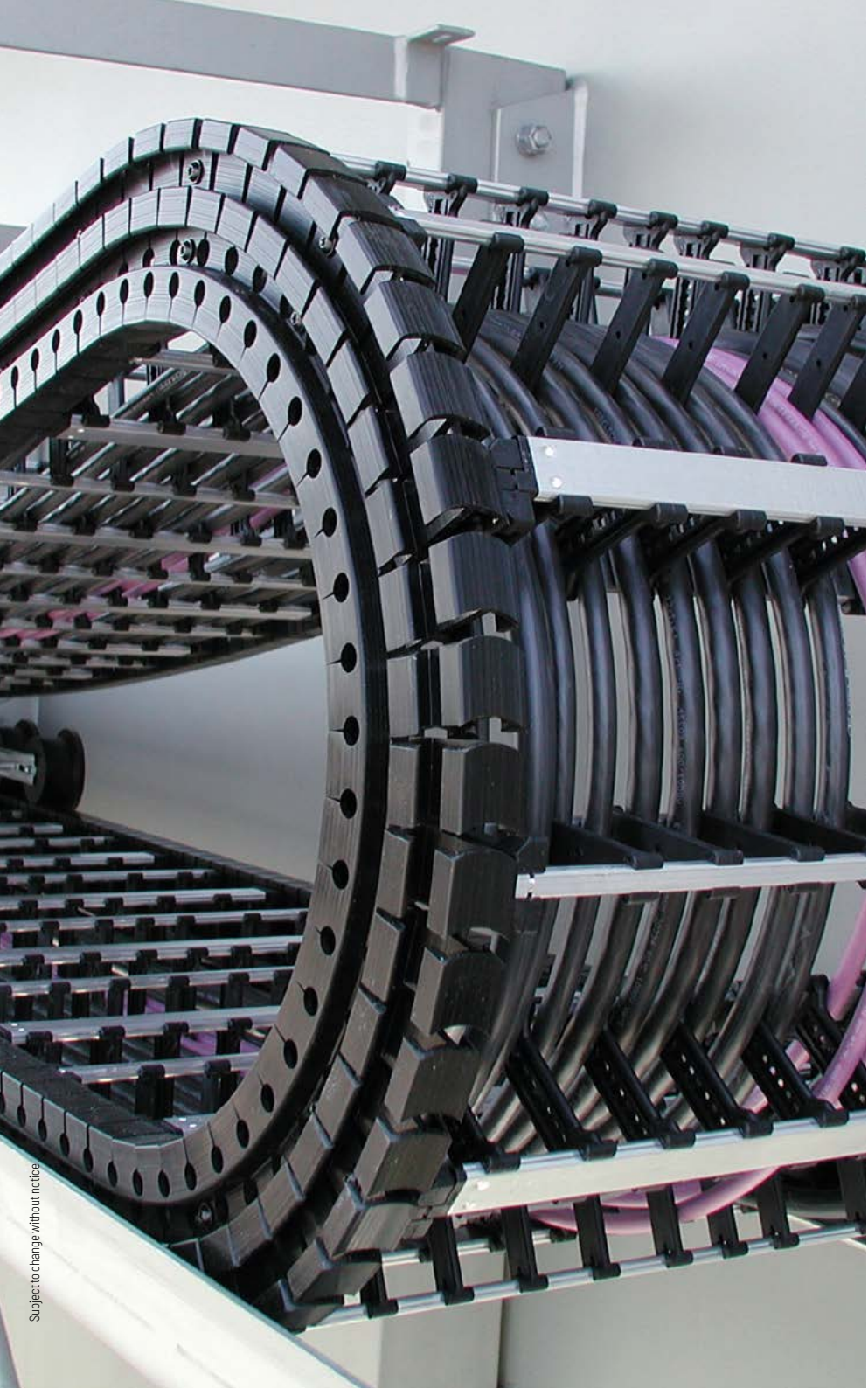

Subject to change without notice

PROTUM®
series

K
series

UNIFLEX
Advanced
series

M
series

XL
series

QUANTUM®
series

TKR
series

TKA
series

UAT
series

Plastic stay RE – frame screw-in stay

- Plastic profile bars for light and medium loads. Assembled without screws.
- Available customized in **16 mm sections**.
- **Outside/inside:** release by rotating 90°.



Stays on every 8th section,
standard (HS: half-stayed)



Stays on every 4th section
(VS: fully-stayed)



8 mm B_i 74 – 570 mm in
16 mm width sections

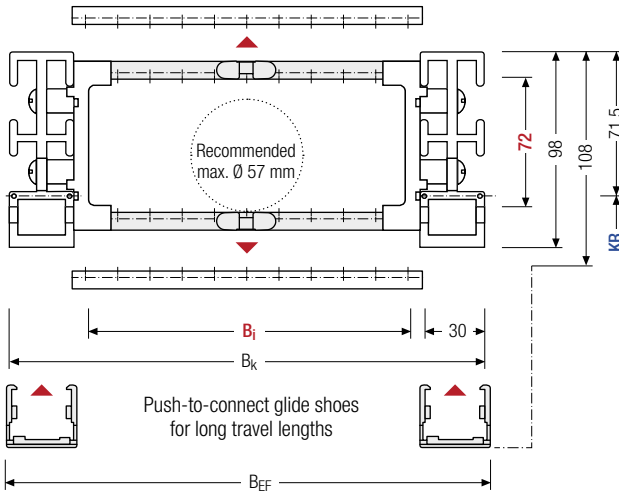

The maximum cable diameter strongly depends on the bending radius and the desired cable type. Please contact us.

Calculating the cable carrier length

Cable carrier length L_k

$$L_k \approx \frac{L_s}{2} + L_B$$

Cable carrier length L_k rounded to pitch t

Number of glide shoes

$$\frac{\text{Pitch per cable carrier length}}{4} \times 2 - 2$$

h _i [mm]	h _G [mm]	h _{G'} [mm]	B _i [mm]								B _k [mm]	B _{EF} [mm]	KR [mm]	q _k [kg/m]			
72	98	108	74	90	106	122	138	154	170	186	202	B _i + 82	B _i + 89.5	180	250	2.74	
			218	234	250	266	282	298	314	330	346			300	370		
			362	378	394	410	426	442	458	474	490			460	600		3.67
			506	522	538	554	570										

Order example



Q100

Type

346

B_i [mm]

RE

Stay variant

370

KR [mm]

1860

L_k [mm]

HS

Stay arrangement

Divider systems

The divider system is mounted on each crossbar as a standard – on every 8th section for stay mounting (HS). As a standard, dividers or the complete divider system (dividers with height separations) are movable in the cross section (**version A**).

For applications with lateral accelerations and applications with the cable carrier rotated by 90°, the dividers can easily be fixed by turning the frame stay by 180°. The arresting cams click into place in the locking grids in the crossbar (**version B**). The groove in the frame stay faces outwards.

Divider system TSO without height separation

Vers.	a _T min [mm]	a _x min [mm]	a _c min [mm]	a _x grid [mm]	n _T min
A	12	14.5	6.5	–	–
B	13	16	8	16	–

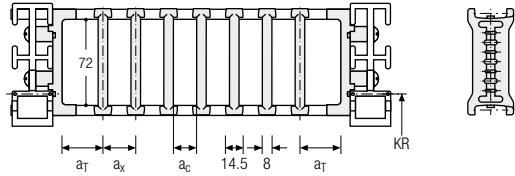

The dividers are movable within the cross section (version A) or fixed (version B).

Divider system TS1 with continuous height separation

Vers.	a _T min [mm]	a _T max [mm]	a _x min [mm]	a _c min [mm]	a _x grid [mm]	n _T min
A	12	25	14.5	6.5	–	2
B	13	29	16	8	16	2

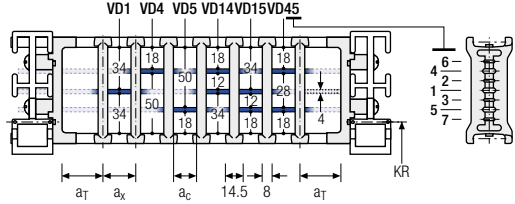

The dividers are movable within the cross section (version A) or fixed (version B).

Divider system TS2 with partial height separation

Vers.	a _T min [mm]	a _x min [mm]	a _c min [mm]	a _x grid [mm]	n _T min
A	12	14.5*20	6.5*/12	–	2
B	13	16*/32	8*/24	16	2

* for VR0

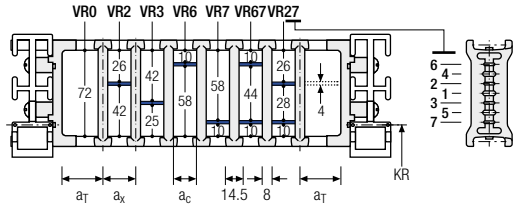

With grid distribution (16 mm grid). The dividers are fixed by the height separation; the grid is movable in the cross section (version A) or fixed (version B).

PROTUM® series
K series
UNIFLEX Advanced series
M series
XL series
QUANTUM® series
TKR series
TKA series
UAT series

Divider system TS3 with height separation consisting of plastic partitions

Vers.	a_T min [mm]	a_x min [mm]	a_c min [mm]	n_T min
A	8	16/42*	8	2

* For aluminum partitions

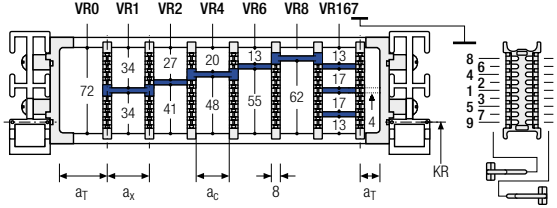

The dividers are fixed with the partitions.
The entire divider system can be moved in the cross section.

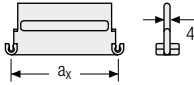

Aluminum partitions in 1 mm increments with $a_x > 42$ mm are also available.

a_x (center distance of dividers) [mm]											
a_c (nominal width of inner chamber) [mm]											
16	18	23	28	32	33	38	43	48	58	64	68
8	10	15	20	24	25	30	35	40	50	56	60
78	80	88	96	112	128	144	160	176	192	208	
70	72	80	88	104	120	136	152	168	184	200	

When using **plastic partitions with $a_x > 112$ mm**, we recommend an additional center support with a **twin divider** ($S_T = 4$ mm). Twin dividers are also suitable for retrofitting in the partition system. The height separations VR8 and VR9 are not possible when using twin dividers.

Order example



TS3	A	2	K1	16	VR1
			⋮	⋮	⋮
			K4	208	VR9
Divider system	Version	n_T	Chamber	a_x	Height separation

Please state the designation of the divider system (**TS0, TS1, ...**), the version, and the number of dividers per cross section [n_T]. In addition, please also enter the chambers [K] from left to right, as well as the assembly distances [a_T/a_x].

When using divider systems with height separation (**TS1 – TS3**), please additionally state the positions (e.g. VD23) viewed from the left driver belt. You are welcome to add a sketch to your order.



TOTALTRAX® complete systems

Benefit from the advantages of the TOTALTRAX® complete system.
A complete delivery from one source – with a warranty certificate on request! Learn more at tsubaki-kabelschlepp.com/totaltrax

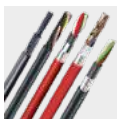

TRAXLINE® cables for cable carriers

Hi-flex electric cables which were especially developed, optimized and tested for use in cable carriers can be found at tsubaki-kabelschlepp.com/traxline

Universal end connectors UMB – plastic (standard)

The universal end connectors (UMB) are made from plastic and can be mounted from the top, from the bottom or face on.

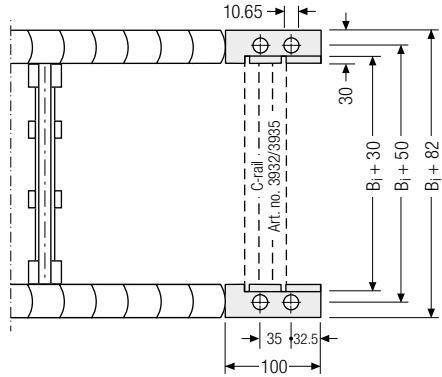
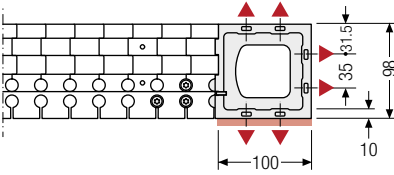

▲ Assembly options

Recommended tightening torque:
 49 Nm for screws M10 - 8.8
 55 Nm for screws M10 - 12.9

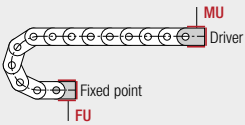

Connection point

F – fixed point
M – driver

Connection type

U – universal end connector

Order example

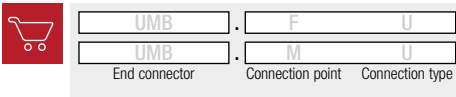

We recommend the use of strain reliefs at the driver and fixed point. See from p. 904.

PROTUM® series
K series
UNIFLEX Advanced series
M series
XL series
QUANTUM® series
TKR series
TKA series
UAT series

More product information online



Assembly instructions etc.:
 Additional info via your smartphone or check online at tsubaki-kabelschlepp.com/downloads



Configure your custom cable carrier here:
online-engineer.de

TKR series

Extremely quiet and low-vibration
for highly dynamic applications*



* Some features can be different
for certain types for design reasons.

Trademarks are legally protected for the TSUBAKI KABELSCHLEPP GmbH
as a national or international registration in the following countries:
tsubaki-kabelschlepp.com/trademarks

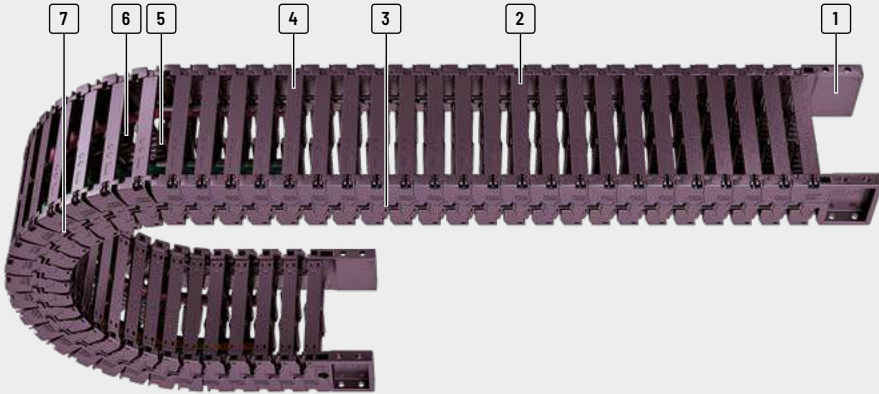

- 1 Variable connection for quick assembly
- 2 Easy and quick to open
- 3 Extremely quiet and low-vibration operation
- 4 Can be opened at any position
- 5 Fixable dividers
- 6 Many separation options for the cables
- 7 Chain link and joint connection with captive connection

Features

- » Long service life
- » Ideal for highly dynamic applications
- » High side stability
- » Cleanroom compatible (ISO Class 3)
- » Modular design allows easy shortening and extending

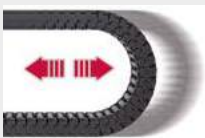
PROTUM®
seriesK
seriesUNIFLEX
Advanced
seriesM
seriesXL
seriesQUANTUM®
seriesTKR
seriesTKA
seriesUAT
series

Ideal for highly dynamic applications



UMB end connector to the connection from the face side, from the top or from the bottom



Molded, captive connecting elements

Type	Opening variant	Stay variant	h_i [mm]	h_G [mm]	B_i [mm]	B_k [mm]	B_i - grid [mm]	t [mm]	KR [mm]	Additional load \leq [kg/m]	Cable- d_{max} [mm]

TKR0150



030

22

275

20-60

34-74

-

15

40-75

2

175

TKR0200



030

28

37

40-120

56-136

-

20

55-150

2,5

22

TKR0260



030

40

54

50-200

76-226

-

26

75-150

8

32

TKR0280



030

52

66

50-200

80-230

-

28

75-200

10

41

TKR0370



RE

28

35

40-80

59-99

-

37

55-100

2,4

25

* For values > 20 m/s², please contact us, we are happy to advise you.

Cleanroom compatible and long service life

The movable connectors are directly molded on the chain links. In contrast to conventional bore-hole bolt connections, hardly any wear occurs (link abrasion), which makes the TKR type excellent for use in clean rooms.

The special design of the connecting elements additionally increases the service life of the system.

Unsupported arrangement			Gliding arrangement			Inner Distribution				Movement			Page
Travel length ≤ [m]	$v_{max} \leq [m/s]$	$a_{max} \leq [m/s^2]$	Travel length ≤ [m]	$v_{max} \leq [m/s]$	$a_{max} \leq [m/s^2]$	TS0	TS1	TS2	TS3	vertical hanging or standing	lying on the side	rotating arrangement	
1,75	5	200*	-	-	-	•	•	-	-	•	-	-	512
2,75	5	200*	-	-	-	•	•	-	-	•	-	-	518
3,9	5	200*	-	-	-	•	•	-	•	•	-	-	524
4,9	5	200*	-	-	-	•	•	-	•	•	-	-	530
2,8	5	200*	-	-	-	•	•	-	-	•	-	-	536

PROTUM® series

K series

UNIFLEX Advanced series

M series

XL series

QUANTUM® series

TKR series

TKA series

UAT series

Ideal for highly dynamic applications

The TKR features extremely quiet and low-vibration operation. The so-called polygon effect is reduced to a minimum. Ideal areas of application are in particular in handling and assembly systems, robots, metrology devices,

pick-and-place machines, printing and textile machines. Due to the **very quiet running**, the TKR types are ideal for **low-vibration applications with linear drives**.

TKR0150

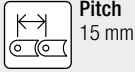

Pitch
15 mm



Inner height
22 mm



Inner widths
20 – 60 mm



Bending radii
40 – 75 mm

Stay variants



Design 030..... page 512

Frame with outside detachable crossbar

- Low-vibration plastic frame with particularly long service life thanks to molded chain links.
- **Outside:** Swivable and detachable.



TOTALTRAX® complete systems

Benefit from the advantages of the TOTALTRAX® complete system. A complete delivery from one source – with a warranty certificate on request! Learn more at tsubaki-kabelschlepp.com/totaltrax



TRAXLINE® cables for cable carriers

Hi-flex electric cables which were especially developed, optimized and tested for use in cable carriers can be found at tsubaki-kabelschlepp.com/traxline

Unsupported arrangement

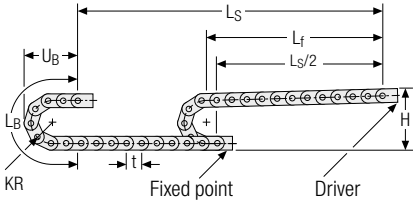

KR [mm]	H [mm]	L _B [mm]	U _B [mm]
40	120	156	70
50	140	187	80
75	190	266	105

Load diagram for unsupported length depending on the additional load.

Sagging of the cable carrier is technically permitted for extended travel lengths, depending on the specific application.

Intrinsic cable carrier weight $q_k = 0.3 \text{ kg/m}$ at B_i 20 mm. For other inner widths, the maximum additional load changes.



Speed
up to 5 m/s



Acceleration
up to 200 m/s²*



Travel length
up to 1.75 m



Additional load
up to 2.0 kg/m

* For values > 20 m/s², please contact us, we are happy to advise you!

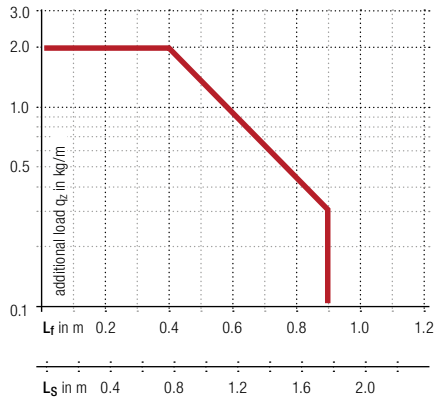

PROTUM® series
K series
UNIFLEX Advanced series
M series
XL series
QUANTUM® series
TKR series
TKA series
UAT series

More product information online



Assembly instructions etc.:
Additional info via your
smartphone or check online at
[tsubaki-kabelschlepp.com/
downloads](http://tsubaki-kabelschlepp.com/downloads)



Configure your custom
cable carrier here:
online-engineer.de

Stay variant 030 – with outside opening and detachable crossbars

- Low-vibration plastic frame with particularly long service life thanks to molded chain links.
- Swivable and detachable on one side in any position.
- **Outside:** Swivable and detachable.



Stay arrangement on each chain link (**VS: fully-stayed**)



B_i 20 – 60 mm

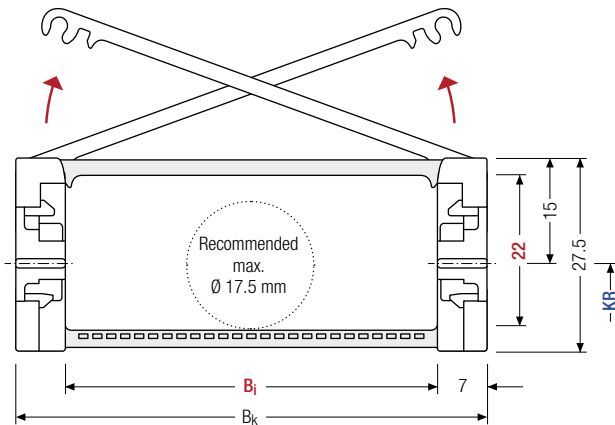

The maximum cable diameter strongly depends on the bending radius and the desired cable type. Please contact us.

Calculating the cable carrier length

Cable carrier length L_k

$$L_k \approx \frac{L_S}{2} + L_B$$

Cable carrier length L_k rounded to pitch t for even number of chain links

h_i [mm]	h_G [mm]	B_i [mm]	B_k [mm]	KR [mm]	q_k [kg/m]
22	27.5	20	40	60	$B_i + 14$
					40
					50
					75
					0.3 – 0.5

Order example



TKR0150

Type

60

B_i [mm]

030

Stay variant

75

KR [mm]

800

L_k [mm]

VS

Stay arrangement

Divider systems

As standard, the divider system is mounted on every 2nd chain link

The dividers are easily attached to the stay for applications with transverse accelerations and for applications laying on the side by simply turning them.

As a standard, dividers and the complete divider system (dividers with height separations) can be moved in the cross section (**version A**).

The arresting cams click into place in the locking grids in the crossbars (**version B**).

Divider system TSO without height separation

Vers.	a _T min [mm]	a _X min [mm]	a _C min [mm]	a _X grid [mm]	n _T min
A	5	6	4	—	—
B	6	6	4	2	—

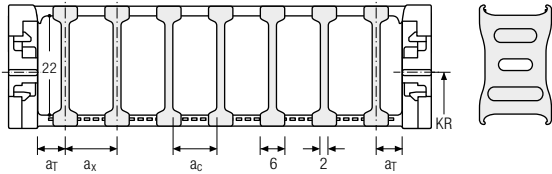

Divider system TS1 with continuous height separation

Vers.	a _T min [mm]	a _X min [mm]	a _C min [mm]	a _X grid [mm]	n _T min
A	5	6	4	—	2
B	6	6	4	2	2

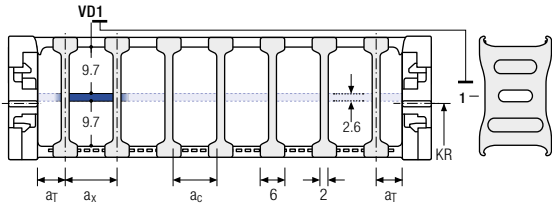

Order example

🛒

TS1

A

3

VD0

⋮

VD1

Divider system

Version

n_T

Height separation

Please state the designation of the divider system (**TS0, TS1 ...**), version and number of dividers per cross section [n_T].

If using divider systems with height separation (**TS1**) please also state the positions [e.g. VD1] viewed from the left driver belt. You are welcome to add a sketch to your order.

	PROTUM® series
	K series
	UNIFLEX Advanced series
	M series
	XL series
	QUANTUM® series
	TKR series
	TKA series
	UAT series

PROTUM®
seriesK
seriesUNIFLEX
Advanced
seriesM
seriesXL
seriesQUANTUM®
seriesTKR
seriesTKA
seriesUAT
series

One-part end connectors – plastic

The plastic end connectors can be **connected from above or from below**. The connection type can be changed by changing the orientation of the end connector.

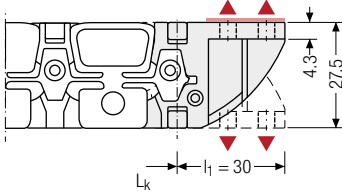

▲ Assembly options

 Recommended tightening torque:
0,6 Nm for screws M4

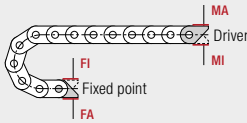
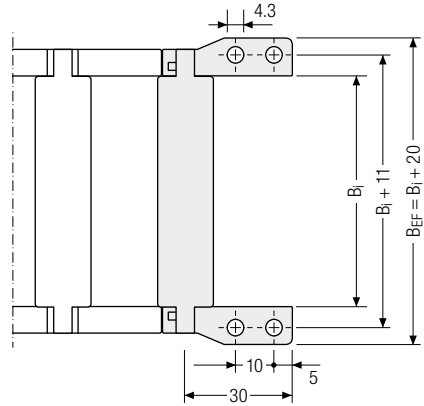

Connection point

F – fixed point
M – driver

Connection type

A – threaded joint outside (standard)
I – threaded joint inside

Order example

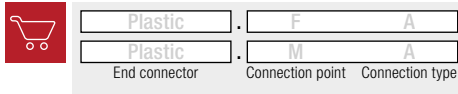

We recommend the use of strain reliefs at the driver and fixed point. See from p. 904.

More product information online



Assembly instructions etc.:
Additional info via your
smartphone or check online at
[tsubaki-kabelschlepp.com/
downloads](http://tsubaki-kabelschlepp.com/downloads)



Configure your custom
cable carrier here:
online-engineer.de



Subject to change without notice.

UAT
series

TKA
series

TKR
series

QUANTUM®
series

XL
series

M
series

UNIFLEX
Advanced
series

K
series

PROTUM®
series

TKR0200



Pitch
20 mm



Inner height
28 mm



Inner widths
40 – 120 mm



Bending radii
55 – 150 mm

Stay variants

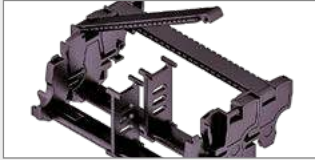

Design 030..... page 518

Frame with outside detachable crossbar

- Low-vibration plastic frame with particularly long service life thanks to molded chain links.
- **Outside:** Swivable and detachable
- **Inside:** detachable



Fraunhofer
TESTED®
DEVICE
TSUBAKIMOTO CHAIN CO.
TRIKOZONSERIES
Report No. KA 1008-531



TOTALTRAX® complete systems

Benefit from the advantages of the TOTALTRAX® complete system. A complete delivery from one source – with a warranty certificate on request! Learn more at tsubaki-kabelschlepp.com/totaltrax

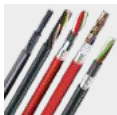

TRAXLINE® cables for cable carriers

Hi-flex electric cables which were especially developed, optimized and tested for use in cable carriers can be found at tsubaki-kabelschlepp.com/traxline

Unsupported arrangement

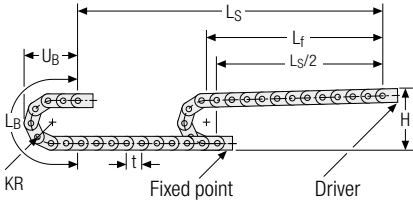

KR [mm]	H [mm]	LB [mm]	UB [mm]
55	182	253	116
75	222	316	136
95	262	379	156
150	372	552	211

Load diagram for unsupported length depending on the additional load.

Sagging of the cable carrier is technically permitted for extended travel lengths, depending on the specific application.

Intrinsic cable carrier weight $q_k = 0.6 \text{ kg/m}$ at $B_i 40 \text{ mm}$. For other inner widths, the maximum additional load changes.

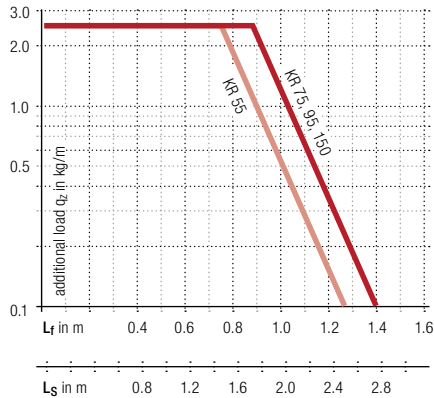

Speed
up to 5 m/s

Acceleration
up to 200 m/s²*

Travel length
up to 2.75 m

Additional load
up to 2.5 kg/m

* For values > 20 m/s², please contact us, we are happy to advise you!

- PROTUM® series
- K series
- UNIFLEX Advanced series
- M series
- XL series
- QUANTUM® series
- TKR series
- TKA series
- UAT series

More product information online



Assembly instructions etc.:
Additional info via your
smartphone or check online at
[tsubaki-kabelschlepp.com/
downloads](http://tsubaki-kabelschlepp.com/downloads)



Configure your custom
cable carrier here:
online-engineer.de

Stay variant 030 – with outside opening and detachable crossbars

- Low-vibration plastic frame with particularly long service life thanks to molded chain links.
- Swivable and detachable on one side in any position.
- **Outside:** Swivable and detachable
- **Inside:** detachable



Stay arrangement on each chain link (**VS: fully-stayed**)



B_i 40 – 120 mm

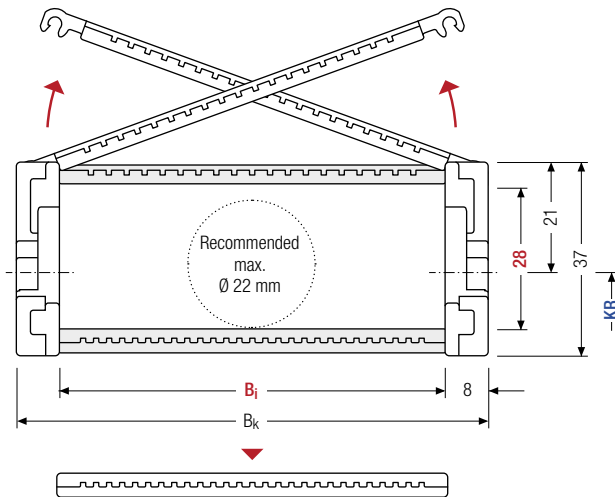

The maximum cable diameter strongly depends on the bending radius and the desired cable type. Please contact us.

Calculating the cable carrier length

Cable carrier length L_k

$$L_k \approx \frac{L_S}{2} + L_B$$

Cable carrier length L_k rounded to pitch t for odd number of chain links

h_i [mm]	h_G [mm]	B_i [mm]						B_k [mm]	KR [mm]				q_k [kg/m]
28	37	40	50	60	80	100	120	$B_i + 16$	55	75	95	150	0.6 – 1.0

Order example



TKR0200

Type

80

B_i [mm]

030

Stay variant

95

KR [mm]

800

L_k [mm]

VS

Stay arrangement

Divider systems

As standard, the divider system is mounted on every 2nd chain link.

Fixable dividers are available for applications with lateral accelerations and for applications lying on the side.

As a standard, dividers and the complete divider system (dividers with height separations) can be moved in the cross section (**version A**).

The arresting cams click into place in the locking grids in the crossbars (**version B**).

Divider system TSO without height separation

Vers.	a _T min [mm]	a _x min [mm]	a _c min [mm]	a _x grid [mm]	n _T min
A	4	8	6	—	—
B	4	8	6	4	—

B _i [mm]	40	50	60	80	100	120
a _T min [mm]	4	5	6	4	6	6

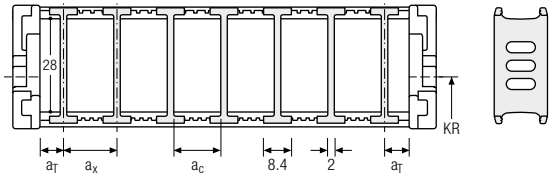

Divider system TS1 with continuous height separation

Vers.	a _T min [mm]	a _x min [mm]	a _c min [mm]	a _x grid [mm]	n _T min
A	4	8	6	—	2
B	4	8	6	4	2

B _i [mm]	40	50	60	80	100	120
a _T min [mm]	4	5	6	4	6	6

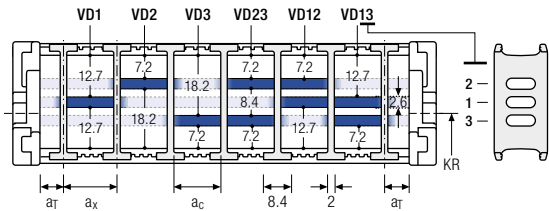

Order example

TS1 · A · 3 - VD0
VD1

Divider system
Version
n_T
Height separation

Please state the designation of the divider system (**TS0, TS1 ...**), version and number of dividers per cross section [n_T].

If using divider systems with height separation (**TS1**) please also state the positions [e.g. VD1] viewed from the left driver belt. You are welcome to add a sketch to your order.

- PROTUM® series
- K series
- UNIFLEX Advanced series
- M series
- XL series
- QUANTUM® series
- TKR series
- TKA series
- UAT series

UMB end connectors UMB – plastic

The universal mounting brackets (UMB) are made from plastic and can be mounted from the top, from the bottom or face on.

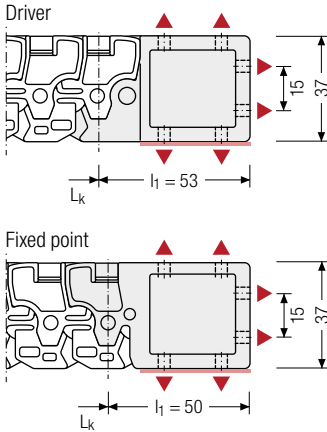

▲ Assembly options

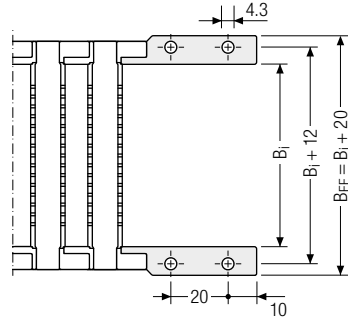

Recommended tightening torque:
0,6 Nm for screws M4

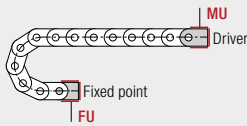

Connection point

F – fixed point
M – driver

Connection type

U – universal mounting bracket

Order example

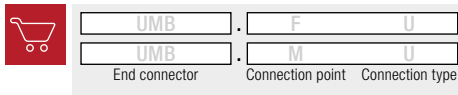

We recommend the use of strain reliefs at the driver and fixed point. See from p. 904.

More product information online



Assembly instructions etc.:
Additional info via your
smartphone or check online at
[tsubaki-kabelschlepp.com/
downloads](http://tsubaki-kabelschlepp.com/downloads)



Configure your custom
cable carrier here:
online-engineer.de



Subject to change without notice.

PROTUM®
series

K
series

UNIFLEX
Advanced
series

M
series

XL
series

QUANTUM®
series

**TKR
series**

TKA
series

UAT
series

TKR0260



Pitch
26 mm



Inner height
40 mm



Inner widths
50 – 200 mm



Bend radii
75 – 150 mm

Stay variants

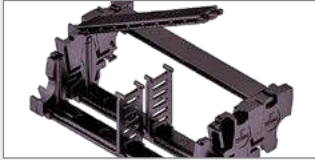

Design 030..... page 524

Frame with outside detachable crossbar

- Low-vibration plastic frame with particularly long service life thanks to molded chain links.
- **Outside:** Swivable and detachable
- **Inside:** detachable



TOTALTRAX® complete systems

Benefit from the advantages of the TOTALTRAX® complete system. A complete delivery from one source – with a warranty certificate on request! Learn more at tsubaki-kabelschlepp.com/totaltrax



TRAXLINE® cables for cable carriers

Hi-flex electric cables which were especially developed, optimized and tested for use in cable carriers can be found at tsubaki-kabelschlepp.com/traxline

Unsupported arrangement

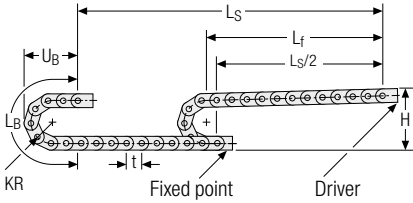

KR [mm]	H [mm]	LB [mm]	UB [mm]
75	238	340	156
100	288	418	181
125	338	497	206
150	388	575	231

Load diagram for unsupported length depending on the additional load.

Sagging of the cable carrier is technically permitted for extended travel lengths, depending on the specific application.

Intrinsic cable carrier weight $q_k = 1.5 \text{ kg/m}$ at B_i 50 mm. For other inner widths, the maximum additional load changes.

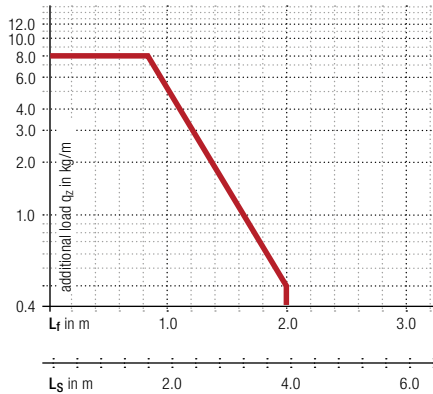

Speed
up to 5 m/s

Acceleration
up to 200 m/s²*

Travel length
up to 3.9 m

Additional load
up to 8.0 kg/m

* For values > 20 m/s², please contact us, we are happy to advise you!

PROTUM® series
K series
UNIFLEX Advanced series
M series
XL series
QUANTUM® series
TKR series
TKA series
UAT series

More product information online



Assembly instructions etc.:
Additional info via your smartphone
or check online at
[tsubaki-kabelschlepp.com/
downloads](http://tsubaki-kabelschlepp.com/downloads)



Configure your custom cable carrier here:
online-engineer.de

Stay variant 030 – with outside opening and detachable crossbars

- Low-vibration plastic frame with particularly long service life thanks to molded chain links.
- Swivable and detachable on one side in any position.
- **Outside:** Swivable and detachable
- **Inside:** detachable



Stay arrangement on each chain link (**VS: fully-stayed**)



B_i 50 – 200 mm

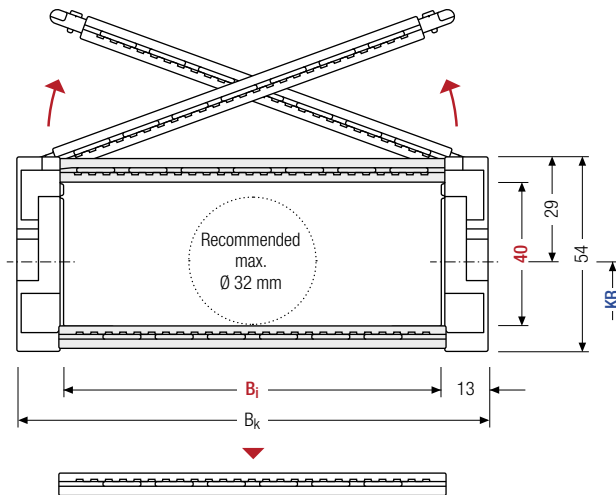

The maximum cable diameter strongly depends on the bending radius and the desired cable type. Please contact us.

Calculating the cable carrier length

Cable carrier length L_k

$$L_k \approx \frac{L_S}{2} + L_B$$

Cable carrier length L_k rounded to pitch t for odd number of chain links

h_i [mm]	h_G [mm]	B_i [mm]								B_k [mm]	KR [mm]				q_k [kg/m]
40	54	50	62	75	87	100	125	150	200	$B_i + 26$	75	100	125	150	1.5 – 2.7

Order example



TKR0260

Type

100

B_i [mm]

030

Stay variant

125

KR [mm]

800

L_k [mm]

VS

Stay arrangement

Divider systems

As standard, the divider system is mounted on every 2nd chain link.

Fixable dividers are available for applications with lateral accelerations and for applications lying on the side.

As a standard, dividers and the complete divider system (dividers with height separations) can be moved in the cross section (**version A**).

The arresting cams click into place in the locking grids in the crossbars (**version B**).

Divider system TS0 without height separation

Vers.	a _T min [mm]	a _X min [mm]	a _C min [mm]	a _X grid [mm]	n _T min
A	3	8	5.6	—	—
B	—	8	5.6	4	—

B _i [mm]	50	62	75	87	100	125	150	200
a _T min [mm]	5	7	5.5	3.5	6	6.5	7	4

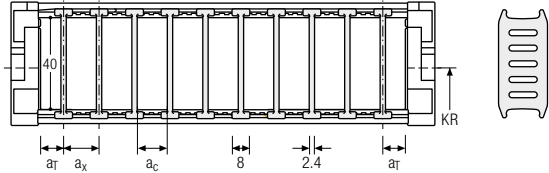

Divider system TS1 with continuous height separation

Vers.	a _T min [mm]	a _X min [mm]	a _C min [mm]	a _X grid [mm]	n _T min
A	3	8	5.6	—	2
B	—	8	5.6	4	2

B _i [mm]	50	62	75	87	100	125	150	200
a _T min [mm]	5	7	5.5	3.5	6	6.5	7	4

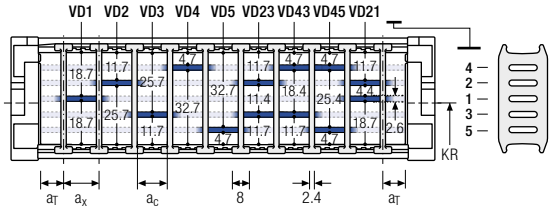

Divider system TS3 with height separation made of aluminum partitions

Vers.	a _T min [mm]	a _X min [mm]	a _C min [mm]	a _X grid [mm]	n _T min
A	3	26	20	—	2
B	—	28	22	4	2

B _i [mm]	50	62	75	87	100	125	150	200
a _T min [mm]	5	7	5.5	3.5	6	6.5	7	4

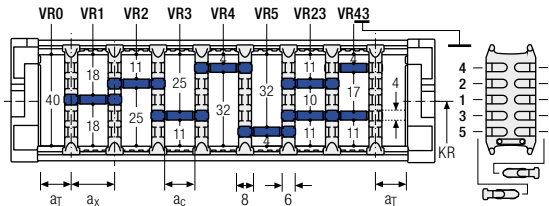

The dividers are fixed by the partitions, the complete divider system is movable in the cross section.

 Aluminum section subdivisions are only available with a_X > 26 mm.

PROTUM® series
K series
UNIFLEX Advanced series
M series
XL series
QUANTUM® series
TKR series
TKA series
UAT series

UMB end connectors UMB – plastic

The universal mounting brackets (UMB) are made from plastic and can be mounted from the top, from the bottom or face on.

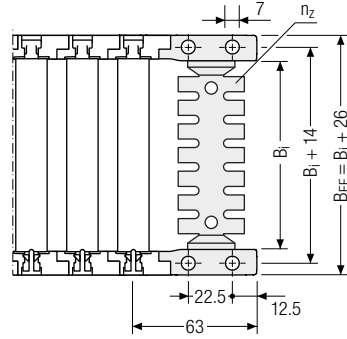
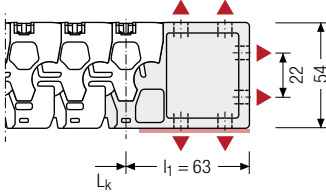

▲ Assembly options

B_i [mm]	B_{EF} [mm]	n_z
50	76	2 x 3
62	88	–
75	101	2 x 5
87	113	–
100	126	2 x 7
125	151	2 x 9
150	176	2 x 11
200	226	–



Recommended tightening torque:
0.6 Nm for screws M4

QUANTUM®
series

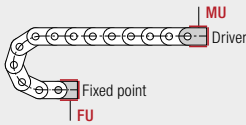

Connection point

F – fixed point
M – driver

Connection type

U – universal mounting
bracket

TKR
series

Order example



UMB	•	F	U
UMB	•	M	U
End connector		Connection point	Connection type



We recommend the use
of strain reliefs at the
driver and fixed point. See from
p. 904.

TKA
series

UAT
series



Subject to change without notice.

UAT series	TKA series	TKR series	QUANTUM® series	XL series	M series	UNIFLEX Advanced series	K series	PROTUM® series
------------	------------	-------------------	-----------------	-----------	----------	-------------------------	----------	----------------

TKR0280



Pitch
28 mm



Inner height
52 mm



Inner widths
50 – 200 mm



Bending radii
75 – 200 mm

Stay variants

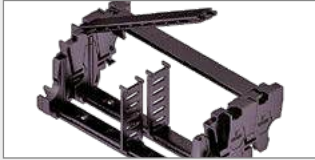

Design 030..... page 530

Frame with outside detachable crossbar

- Low-vibration plastic frame with particularly long service life thanks to molded chain links.
- **Outside:** Swivable and detachable
- **Inside:** detachable



TOTALTRAX® complete systems

Benefit from the advantages of the TOTALTRAX® complete system. A complete delivery from one source – with a warranty certificate on request! Learn more at tsubaki-kabelschlepp.com/totaltrax



TRAXLINE® cables for cable carriers

Hi-flex electric cables which were especially developed, optimized and tested for use in cable carriers can be found at tsubaki-kabelschlepp.com/traxline

Unsupported arrangement

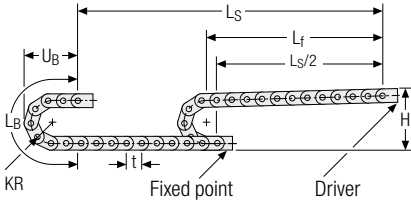

KR [mm]	H [mm]	LB [mm]	UB [mm]
75	252	348	167
100	302	427	192
150	402	584	242
200	502	741	292

Load diagram for unsupported length depending on the additional load.

Sagging of the cable carrier is technically permitted for extended travel lengths, depending on the specific application.

Intrinsic cable carrier weight $q_k = 2.0 \text{ kg/m}$ at B_i 50 mm. For other inner widths, the maximum additional load changes.

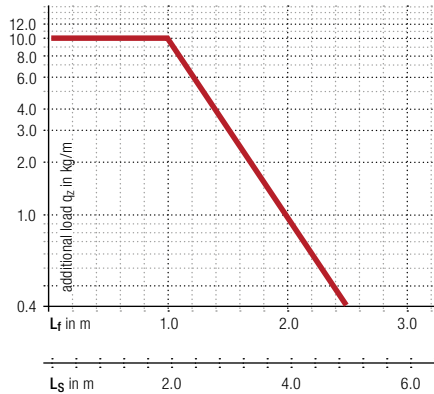

Speed
up to 5 m/s

Acceleration
up to 200 m/s²*

Travel length
up to 4.9 m

Additional load
up to 10.0 kg/m

* For values > 20 m/s², please contact us, we are happy to advise you!

PROTUM® series

K series

UNIFLEX Advanced series

M series

XL series

QUANTUM® series

TKR series

TKA series

UAT series

More product information online



Assembly instructions etc.:
Additional info via your smartphone or check online at tsubaki-kabelschlepp.com/downloads



Configure your custom cable carrier here:
online-engineer.de

Stay variant 030 – with outside opening and detachable crossbars

- Low-vibration plastic frame with particularly long service life thanks to molded chain links.
- Swivable and detachable on one side in any position.
- **Outside:** Swivable and detachable
- **Inside:** detachable



Stay arrangement on each chain link (**VS: fully-stayed**)



B_i 50 – 200 mm

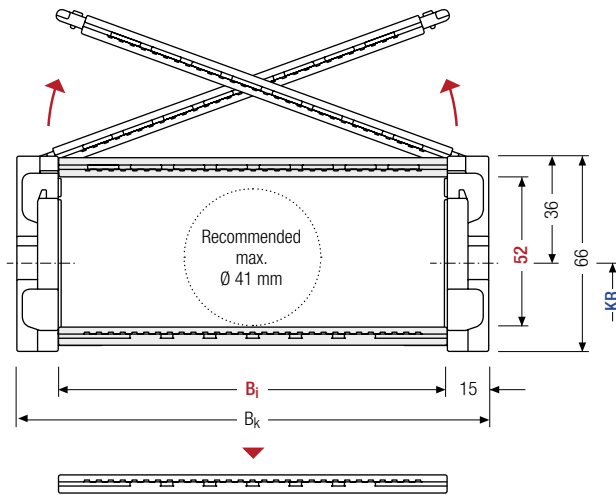

The maximum cable diameter strongly depends on the bending radius and the desired cable type. Please contact us.

Calculating the cable carrier length

Cable carrier length L_k

$$L_k \approx \frac{L_S}{2} + L_B$$

Cable carrier length L_k rounded to pitch t for odd number of chain links

h_i [mm]	h_G [mm]	B_i [mm]								B_k [mm]	KR [mm]				q_k [kg/m]
52	66	50	62	75	87	100	125	150	200	$B_i + 30$	75	100	150	200	2.0 – 3.2

Order example



TKR0280

Type

100

B_i [mm]

030

Stay variant

150

KR [mm]

840

L_k [mm]

VS

Stay arrangement

UMB end connectors UMB – plastic

The universal mounting brackets (UMB) are made from plastic and can be mounted from the top, from the bottom or face on.

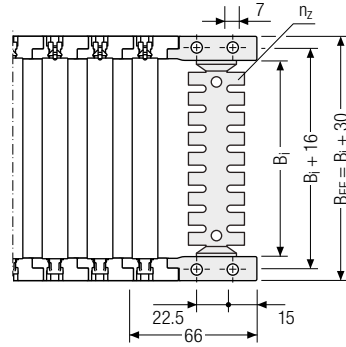
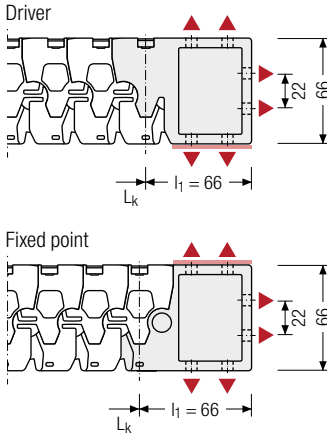

▲ Assembly options

B_i [mm]	B_{EF} [mm]	n_z
50	80	2 x 3
62	92	–
75	105	2 x 5
87	117	–
100	130	2 x 7
125	155	2 x 9
150	180	2 x 11
200	230	–

 Recommended tightening torque:
0.6 Nm for screws M4

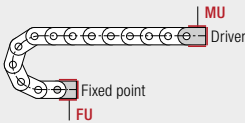

Connection point

F – fixed point
M – driver

Connection type

U – universal mounting bracket

Order example

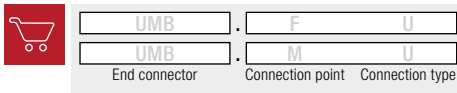

 We recommend the use of strain reliefs at the driver and fixed point. See from p. 904.



UAT
series

TKA
series

TKR
series

QUANTUM®
series

XL
series

M
series

UNIFLEX
Advanced
series

K
series

PROTUM®
series

TKR0370



Pitch
37 mm



Inner height
28 mm



Inner widths
40 – 80 mm



Bending radii
55 – 100 mm

Stay variants



Plastic stay RE page 536

Frame screw-in stay

- Plastic stay for light to medium loads. Assembly without screws.
- **Outside/inside:** to open by rotating.



TOTALTRAX® complete systems

Benefit from the advantages of the TOTALTRAX® complete system. A complete delivery from one source – with a warranty certificate on request! Learn more at tsubaki-kabelschlepp.com/totaltrax

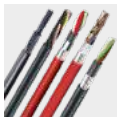

TRAXLINE® cables for cable carriers

Hi-flex electric cables which were especially developed, optimized and tested for use in cable carriers can be found at tsubaki-kabelschlepp.com/traxline

Unsupported arrangement

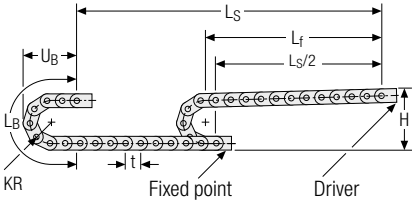

KR [mm]	H [mm]	LB [mm]	UB [mm]
75	252	348	167
100	302	427	192
150	402	548	242
200	502	741	292

Load diagram for unsupported length depending on the additional load.

Sagging of the cable carrier is technically permitted for extended travel lengths, depending on the specific application.

Intrinsic cable carrier weight $q_k = 0.55 \text{ kg/m}$ at B_i 50 mm. For other inner widths, the maximum additional load changes.

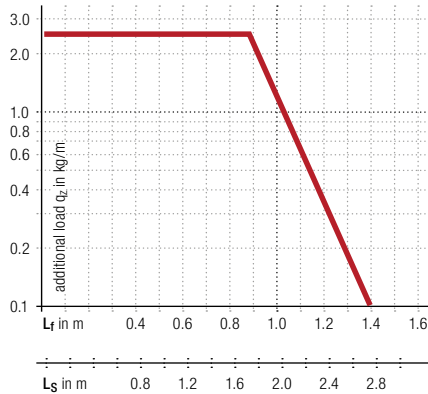

Speed
up to 5 m/s



Acceleration
up to 200 m/s²*



Travel length
up to 2.8 m



Additional load
up to 2.4 kg/m

* For values > 20 m/s², please contact us, we are happy to advise you!

PROTUM® series

K series

UNIFLEX Advanced series

M series

XL series

QUANTUM® series

TKR series

TKA series

UAT series

More product information online



Assembly instructions etc.:
Additional info via your smartphone or check online at tsubaki-kabelschlepp.com/downloads



Configure your custom cable carrier here:
online-engineer.de

Plastic stay RE – screw-in frame stay

- Plastic stay for light and medium loads.
Assembly without screws.
- Available in 5 widths.
- **Outside/inside:** to open by rotating.

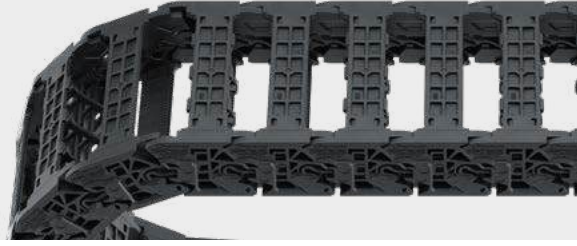

Stay arrangement on each chain link (**VS: fully-stayed**)



B_i 40 – 80 mm

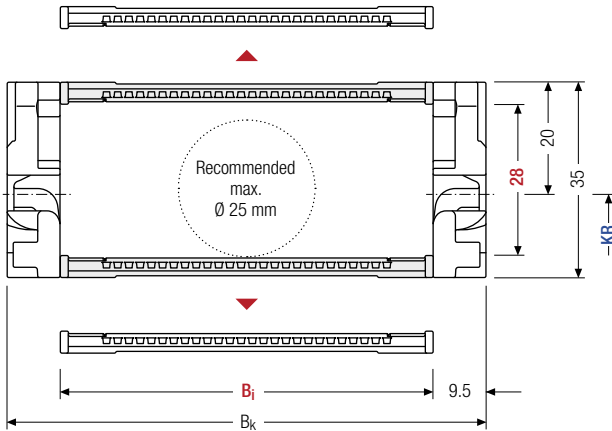

The maximum cable diameter strongly depends on the bending radius and the desired cable type. Please contact us.

Calculating the cable carrier length

Cable carrier length L_k

$$L_k \approx \frac{L_s}{2} + L_B$$

Cable carrier length L_k rounded to pitch t for odd number of chain links

h_i [mm]	h_G [mm]	B_i [mm]					B_k [mm]	KR [mm]			q_k [kg/m]
28	35	40	50	60	70	80	$B_i + 19$	55	75	100	0.53 – 0.61

Order example



TKR0370

Type

80

B_i [mm]

RE

Stay variant

75

KR [mm]

703

L_k [mm]

VS

Stay arrangement

Divider systems

As standard, the divider system is mounted on every 2nd chain link.

Fixable dividers are available for applications with lateral accelerations and for applications lying on the side.

As a standard, dividers and the complete divider system (dividers with height separations) can be moved in the cross section (**version A**).

The arresting cams click into place in the locking grids in the crossbars (**version B**).

Divider system TSO without height separation

Vers.	a _T min [mm]	a _x min [mm]	a _c min [mm]	a _x Raster [mm]	n _T min
A	7.5	8	6	—	—
B	7.5	8	6	2	—

B _i [mm]	40	50	60	70	80
a _T min [mm]	8	9	8	9	8

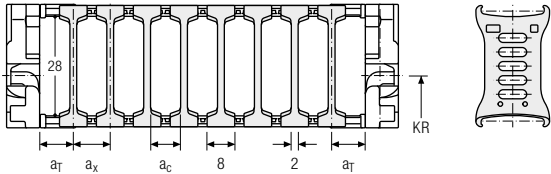

Divider system TS1 with continuous height separation

Vers.	a _T min [mm]	a _x min [mm]	a _c min [mm]	a _x Raster [mm]	n _T min
A	7.5	8	6	—	2
B	7.5	8	6	2	2

B _i [mm]	40	50	60	70	80
a _T min [mm]	8	9	8	9	8

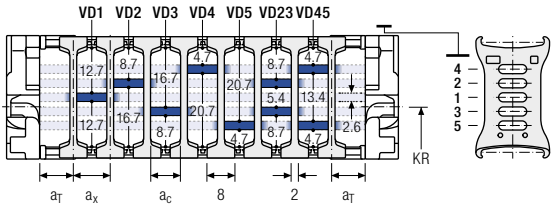

Order example

TS1

·

A

·

3

-

VD0

⋮

-

VD1

Divider system
Version
n_T
Height separation

Please state the designation of the divider system (**TS0, TS1 ...**), version and number of dividers per cross section [n_T].

If using divider systems with height separation (**TS1**) please also state the positions [e.g. VD1] viewed from the left driver belt. You are welcome to add a sketch to your order.

PROTUM® series
K series
UNIFLEX Advanced series
M series
XL series
QUANTUM® series
TKR series
TKA series
UAT series

UMB end connectors UMB – plastic

The universal mounting brackets (UMB) are made from plastic and can be mounted from the top, from the bottom or face on.

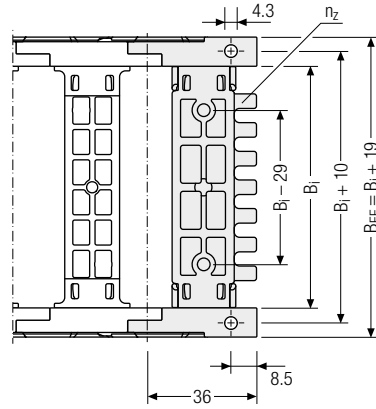
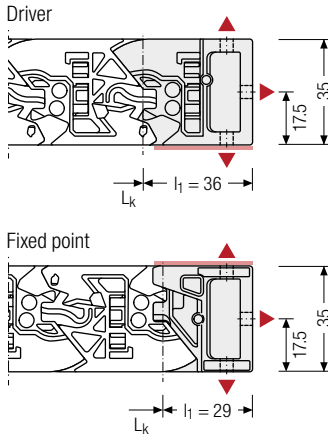

▲ Assembly options

B_i [mm]	B_{EF} [mm]	n_z
40	59	3
50	69	4
60	79	5
70	89	6
80	99	7

Recommended tightening torque:
0.6 Nm for screws M4

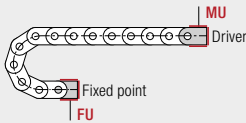

Connection point

F – fixed point
M – driver

Connection type

U – universal mounting bracket

Order example

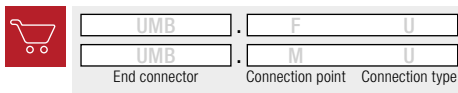



UAT
series

TKA
series

TKR
series

QUANTUM®
series

XL
series

M
series

UNIFLEX
Advanced
series

K
series

PROTUM®
series

PROTUM®
seriesK
seriesUNIFLEX
Advanced
seriesM
seriesXL
seriesQUANTUM®
seriesTKR
seriesTKA
seriesUAT
series

TUBES-PLASTIC

Covered solid plastic and hybrid cable carriers

These covered product types ensure optimum protection of the cables and hoses against chips and other dirt. Variable separations within the cable carrier allow reliable and efficient partitioning. Hoses and cables with larger diameters can also be accommodated and guided.

- » Covered cable carriers with plastic or aluminum cover systems
- » Aluminum cover systems in 1 mm width sections
- » To protect cables and hoses against chips or dirt
- » Easy and quick to open inside and outside



TKA series Page **570**
Chip-tight right to the end



UAT series Page **602**
**Extremer Leitungsschutz
 in rauen Umgebungsbedingungen**

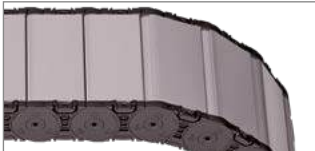

TKA series Page **612**
**Variable, closed cable carrier with extensive range
 of accessories**

PROTUM®
seriesK
seriesUNIFLEX
Advanced
seriesM
seriesXL
seriesQUANTUM®
seriesTKR
seriesTKA
seriesUAT
series

XLT series Page 658

Tubes with variable cable carrier widths

TKA series

Chip-tight right to the end

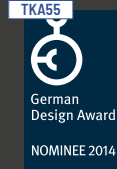

* Refers to type TKA55 with BI 50 - 175.
More information on certification can be found at:
tsubaki-kabelschlepp.com/tka-ip54

Trademarks are legally protected for the TSUBAKI KABELSCHLEPP GmbH as a national or international registration in the following countries:
tsubaki-kabelschlepp.com/trademarks

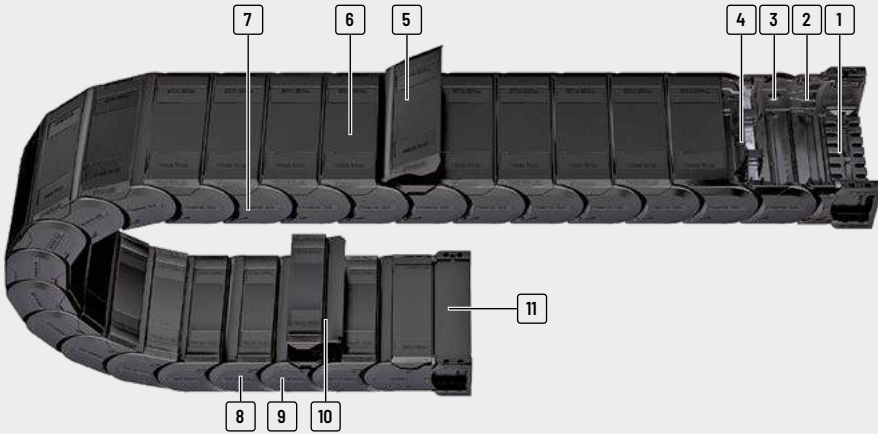

- | | | | |
|--|---|--|---|
| <p>1 End connectors with optional strain relief</p> <p>2 Interior gentle on the cables without projecting edges</p> <p>3 Integrated noise damping</p> | <p>4 Dividers and height separations for separating the cables</p> <p>5 Quick and easy opening from any position</p> <p>6 Secure cover attachment even under severe stresses (e.g. from hydraulic lines)</p> | <p>7 Chain links made of glass-fiber reinforced plastic</p> <p>8 Bolt/hole connection and stroke system covered completely</p> <p>9 Designs with inward or outward opening cross-bars</p> | <p>10 Covers completely detachable on one side</p> <p>11 Cover sheet for universal end connectors</p> |
|--|---|--|---|

Features

- » Excellent cable protection in the connector area
- » Chip and dirt resistant due to smooth surfaces
- » Extensive unsupported length
- » High torsional rigidity
- » Low noise emission
- » Numerous custom material types for custom applications available
- » Easy-to-open cover with simultaneously high retention force on the chain link during operation
- » Measurement scale for easy alignment of the dividers
- » TKA55: IP54 tested and certified*

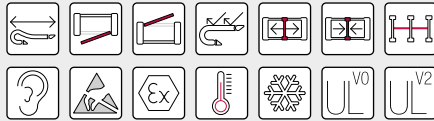

Optimized utilization of the interior space; vertical and horizontal inner distribution possible



Easy-open covers from any position offer secure fastening



Triple-stroke system for extensive unsupported length



Universal end connector with option for integrating strain relief elements

PROTUM®
seriesK
seriesUNIFLEX
Advanced
seriesM
seriesXL
seriesQUANTUM®
seriesTKR
seriesTKA
seriesUAT
series

Type	Opening variant	Stay variant	h_i [mm]	h_G [mm]	B_i [mm]	B_k [mm]	B_i - grid [mm]	t [mm]	KR [mm]	Additional load ≤ [kg/m]	Cable- d_{max} [mm]
PROTUM® series											
TKA30											
		060	20.5	28.5	15 - 65	28 - 78	-	30.5	55 - 180	3	16
		080	20.5	28.5	15 - 65	28 - 78	-	30.5	55 - 180	3	16
UNIFLEX Advanced series											
TKA38											
		060	26	36	25 - 130	41 - 146	-	38.5	70 - 230	5	20
		080	26	36	25 - 130	41 - 146	-	38.5	70 - 230	5	20
M series											
TKA45											
		060	36	50	50 - 150	66 - 166	-	45.5	82 - 230	6	28.5
		080	36	50	50 - 150	66 - 166	-	45.5	82 - 230	6	28.5
XL series											
TKA55											
		060	45	64	50 - 250	70 - 270	-	55.5	100 - 300	15	36
		080	45	64	50 - 250	70 - 270	-	55.5	100 - 300	15	36
QUANTUM® series											
TKR series											
TKA series											
UAT series											

Unsupported arrangement			Gliding arrangement			Inner Distribution				Movement			Page
Travel length ≤ [m]	$v_{max} \leq [m/s]$	$a_{max} \leq [m/s^2]$	Travel length ≤ [m]	$v_{max} \leq [m/s]$	$a_{max} \leq [m/s^2]$	TS0	TS1	TS2	TS3	vertical hanging or standing	lying on the side	rotating arrangement	
3.5	10	50	80	2.5	25	•	•	-	-	•	•	-	548
3.5	10	50	80	2.5	25	•	•	-	-	•	•	-	549
<hr/>													
3.9	10	50	120	2.5	20	•	•	-	-	•	•	-	554
3.9	10	50	120	2.5	20	•	•	-	-	•	•	-	555
<hr/>													
4.7	9	45	125	3	20	•	•	-	•	•	•	-	560
4.7	9	45	125	3	20	•	•	-	•	•	•	-	561
<hr/>													
6.5	8	40	150	3	15	•	•	-	•	•	•	-	568
6.5	8	40	150	3	15	•	•	-	•	•	•	-	569

PROTUM® series

K series

UNIFLEX Advanced series

M series

XL series

QUANTUM® series

TKR series

TKA series

UAT series

TKA30

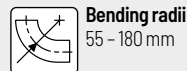

Stay variants



Design 060 page 548

Covered on both sides with inside detachable cover

- » Plastic cover for rough environmental conditions with dirt, chips or spray water.
- » Fully detachable on one side in any position.
- » **Inside:** very quick release.



Design 080 page 549

Covered on both sides with outside detachable cover

- » Plastic cover for rough environmental conditions with dirt, chips or spray water.
- » Fully detachable on one side in any position.
- » **Outside:** very quick release.

Unsupported arrangement

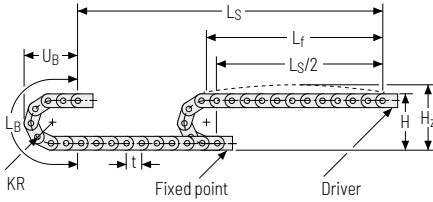





KR [mm]	H [mm]	H _z [mm]	L _B [mm]	U _B [mm]
55	139	164	234	100
75	179	204	297	120
95	219	244	359	140
125	279	304	454	170
145	319	344	516	190
180	389	414	626	225

Load diagram for unsupported length depending on the additional load.

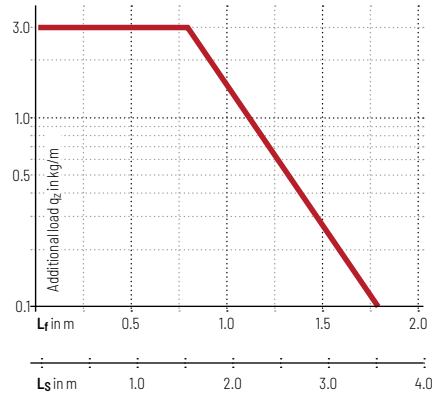
Sagging of the cable carrier is technically permitted for extended travel lengths, depending on the specific application.





Intrinsic cable carrier weight $q_k = 0.67 \text{ kg/m}$ at B; 50 mm. For other inner widths, the maximum additional load changes.

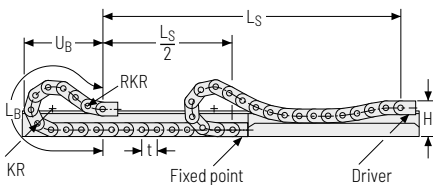

-  **Speed**
up to 10 m/s
-  **Acceleration**
up to 50 m/s²
-  **Travel length**
up to 3.5 m
-  **Additional load**
up to 3 kg/m

Gliding arrangement



-  **Speed**
up to 2.5 m/s
-  **Acceleration**
up to 25 m/s²
-  **Travel length**
up to 80 m
-  **Additional load**
up to 3 kg/m

 The gliding cable carrier has to be routed in a channel. See p. 844.

PROTUM® series
K series
UNIFLEX Advanced series
M series
XL series
QUANTUM® series
TKR series
TKA series
UAT series

Stay variant 060 – covered on both sides with inside detachable cover

- » Plastic cover for rough environmental conditions with dirt, chips or spray water.
- » Fully detachable on one side in any position.
- » **Inside:** very quick release.



Stay arrangement on each chain link (**VS: fully-stayed**)



B_i 15 – 65 mm

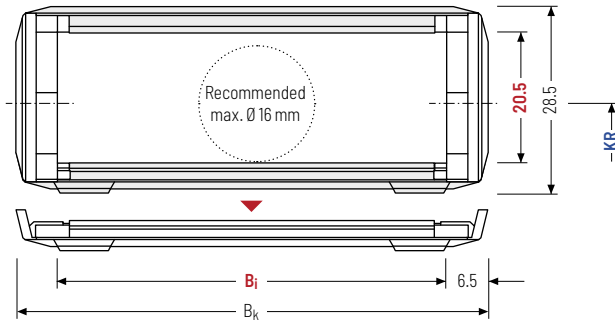

The maximum cable diameter strongly depends on the bending radius and the desired cable type. Please contact us.

Calculating the cable carrier length

Cable carrier length L_k

$$L_k \approx \frac{L_S}{2} + L_B$$

Cable carrier length L_k rounded to pitch t

h_i [mm]	h_g [mm]	B_i [mm]						B_k [mm]	KR [mm]						q_k [kg/m]
20,5	28,5	15	20	25	38	50	65	$B_i + 13$	55	75	95	125	145	180	0,48 – 0,76

Order example



TKA30

Type

060

Stay variant

50

B_i [mm]

125

KR [mm]

915

L_k [mm]

VS

Stay arrangement

Stay variant 080 – covered on both sides with outside detachable cover

- » Plastic cover for rough environmental conditions with dirt, chips or spray water.
- » Fully detachable on one side in any position.
- » **Outside:** very quick release.



 Stay arrangement on each chain link (**VS: fully-stayed**)

 B_i 15 – 65 mm

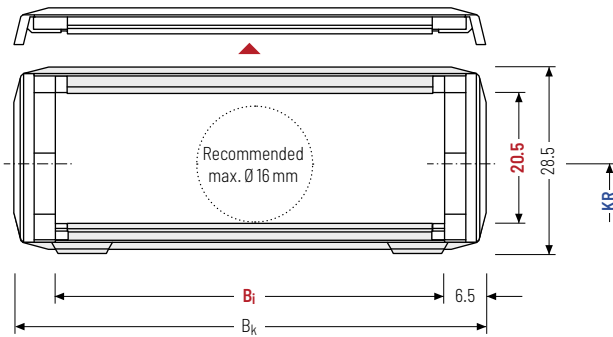

 The maximum cable diameter strongly depends on the bending radius and the desired cable type. Please contact us.

Calculating the cable carrier length

Cable carrier length L_k

$$L_k \approx \frac{L_S}{2} + L_B$$

Cable carrier length L_k rounded to pitch t

h_i [mm]	h_g [mm]	B_i [mm]						B_k [mm]	KR [mm]					q_k [kg/m]	
20,5	28,5	15	20	25	38	50	65	$B_i + 13$	55	75	95	125	145	180	0.48 – 0.76

Order example

 **TKA30** . **080** . **50** . **125** . **915** . **VS**
 Type Stay variant B_i [mm] KR [mm] L_k [mm] Stay arrangement

Divider systems

As a standard, the divider system is mounted on every 2nd chain link.

As a standard, dividers, or the complete divider system (dividers with height separations) are movable in the cross section (**version A**).

The dividers are easily attached to the stay for applications with transverse accelerations and for applications laying on the side by simply turning them.

The locking cams click into place in the locking grids in the covers (**version B**).

Divider system TSO without height separation

Vers.	a _T min [mm]	a _x min [mm]	a _c min [mm]	a _x grid [mm]	η _T min
A	3.5	7	5	-	-
B	8	8	6	2	-

B _i [mm]	15	20	25	38	50	65
a _T min [mm]	7.5	8	8.5	9	9	8.5

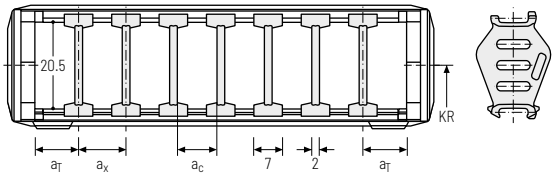

Divider system TS1 with continuous height separation

Vers.	a _T min [mm]	a _x min [mm]	a _c min [mm]	a _x grid [mm]	η _T min
A	3.5	7	5	-	2
B	8	8	6	2	2

B _i [mm]	15	20	25	38	50	65
a _T min [mm]	7.5	8	8.5	9	9	8.5

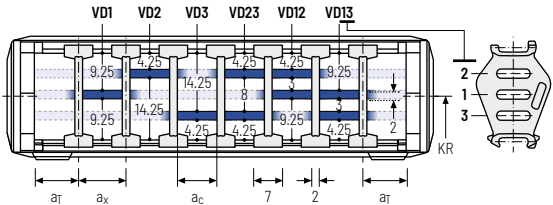

Order example



TS1	.	A	.	3	-	V00
⋮						
						V01
Divider system		Version		η _T		Height separation

Please state the designation of the divider system (**TS0, TS1...**), version and number of dividers per cross section [η_T].

If using divider systems with height separation (**TS1**) please also state the positions [e.g. VD1] viewed from the left driver belt. You are welcome to add a sketch to your order.

Universal end connectors UMB – plastic (standard)

The universal end connectors (UMB) are made from plastic and can be mounted from the top, from the bottom, or face on.

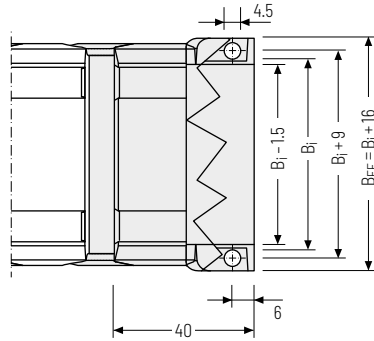
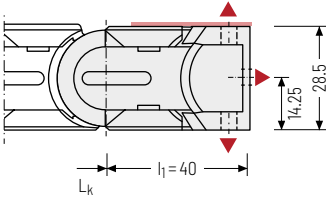

▲ Assembly options

 Recommended tightening torque: 3 Nm for cheese-head screws ISO 4762 - M4 x 12

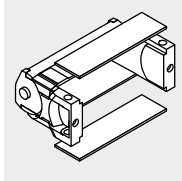
 The end connectors are also available as an option **without** cover sheets. Please state when ordering.

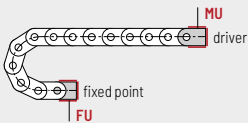

Connection point
F - fixed point
M - driver

Connection type
U - Universal mounting bracket

Order example

	UMB	.	F	U
	UMB	.	M	U
	End connector		Connection point	Connection type

 We recommend the use of strain reliefs before driver and fixed point. See from p. 904.

PROTUM® series
K series
UNIFLEX Advanced series
M series
XL series
QUANTUM® series
TKR series
TKA series
UAT series

TKA38



Pitch
38.5 mm



Inner height
26 mm



Inner widths
25 – 130 mm



Bending radii
70 – 230 mm

Stay variants



Design 060 page **554**

Covered on both sides with inside detachable cover

- » Plastic cover for rough environmental conditions with dirt, chips or spray water.
- » Fully detachable on one side in any position.
- » **Inside:** very quick release.



Design 080 page **555**

Covered on both sides with outside detachable cover

- » Plastic cover for rough environmental conditions with dirt, chips or spray water.
- » Fully detachable on one side in any position.
- » **Outside:** very quick release.

Unsupported arrangement

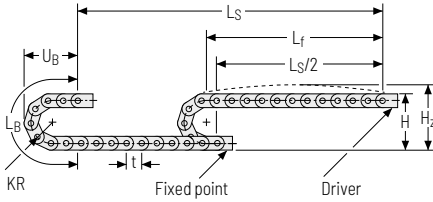





KR [mm]	H [mm]	H ₂ [mm]	L _B [mm]	U _B [mm]
70	176	201	297	127
95	226	251	375	152
120	276	301	454	177
145	326	351	532	202
170	376	401	611	227
195	426	451	689	252
230	496	521	799	287

Load diagram for unsupported length depending on the additional load.

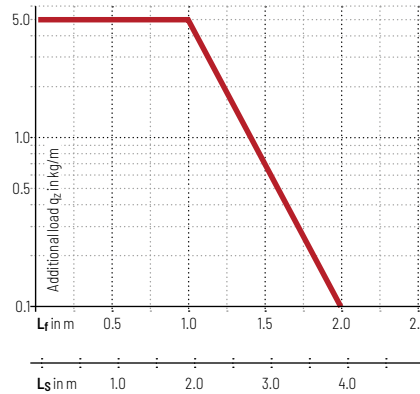
Sagging of the cable carrier is technically permitted for extended travel lengths, depending on the specific application.





Intrinsic cable carrier weight $q_k = 1.13 \text{ kg/m}$ at B_i 78 mm. For other inner widths, the maximum additional load changes.

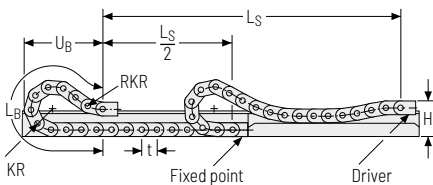

-  **Speed**
up to 10 m/s
-  **Acceleration**
up to 50 m/s²
-  **Travel length**
up to 3.9 m
-  **Additional load**
up to 5 kg/m

Gliding arrangement



-  **Speed**
up to 2.5 m/s
-  **Acceleration**
up to 20 m/s²
-  **Travel length**
up to 120 m
-  **Additional load**
up to 5 kg/m

 The gliding cable carrier has to be routed in a channel. See p. 844.

PROTUM® series
K series
UNIFLEX Advanced series
M series
XL series
QUANTUM® series
TKR series
TKA series
UAT series

Stay variant 060 – covered on both sides with inside detachable cover

- » Plastic cover for rough environmental conditions with dirt, chips or spray water.
- » Fully detachable on one side in any position.
- » **Inside:** very quick release.



Stay arrangement on each chain link (**VS: fully-stayed**)



B_i : 25 – 130 mm

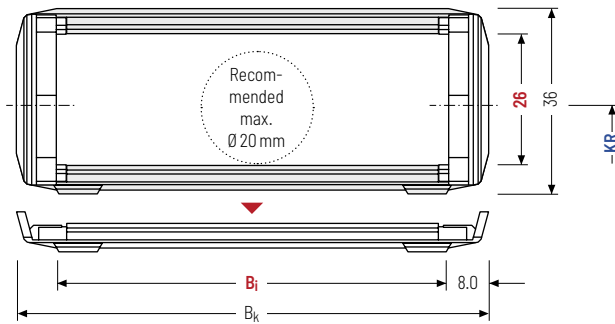

The maximum cable diameter strongly depends on the bending radius and the desired cable type. Please contact us.

Calculating the cable carrier length

Cable carrier length L_k

$$L_k \approx \frac{L_S}{2} + L_B$$

Cable carrier length L_k rounded to pitch t

h_i [mm]	h_g [mm]	B_i [mm]		B_k [mm]	KR [mm]				q_k [kg/m]							
26	36.75	25	38	58	78	103	130	$B_i + 16$	70	95	120	145	170	195	230	0.77 - 1.47

Order example



TKA38

Type

060

Stay variant

78

B_i [mm]

145

KR [mm]

1155

L_k [mm]

VS

Stay arrangement

Stay variant 080 – covered on both sides with outside detachable cover

- » Plastic cover for rough environmental conditions with dirt, chips or spray water.
- » Fully detachable on one side in any position.
- » **Outside:** very quick release.

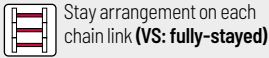

Stay arrangement on each chain link (**VS: fully-stayed**)



B_i 25 – 130 mm

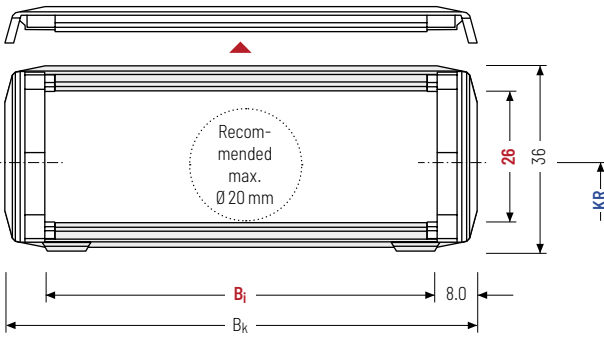

The maximum cable diameter strongly depends on the bending radius and the desired cable type. Please contact us.

Calculating the cable carrier length

Cable carrier length L_k

$$L_k \approx \frac{L_S}{2} + L_B$$

Cable carrier length L_k rounded to pitch t

h_i [mm]	h_c [mm]	B_i [mm]							B_k [mm]	KR [mm]							q_k [kg/m]
26	36.75	25	38	58	78	103	130	$B_i + 16$	70	95	120	145	170	195	230	0.77 – 1.47	

Order example

TKA38 ·
 080 ·
 78 ·
 145 ·
 1155 ·
 VS

Type Stay variant B_i [mm] KR [mm] L_k [mm] Stay arrangement

Divider systems

As a standard, the divider system is mounted on every 2nd chain link.

As a standard, dividers or the complete divider system (dividers with height separations) are movable in the cross section (**version A**).

The dividers are easily attached to the stay for applications with transverse accelerations and for applications laying on the side by simply turning them.

The locking cams click into place in the locking grids in the covers (**version B**).

Divider system TSO without height separation

Vers.	a _T min [mm]	a _x min [mm]	a _c min [mm]	a _x grid [mm]	nr min
A	3.5	7	5	-	-
B	8	8	6	2	-
B_i [mm] 25 38 58 78 103 130					
a_T min [mm] 8.5 9 9 9 7.5 9					

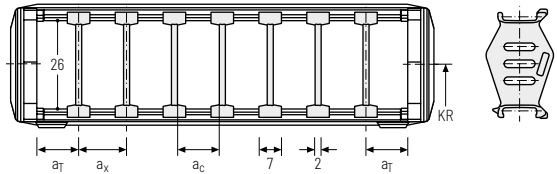

Divider system TS1 with continuous height separation

Vers.	a _T min [mm]	a _x min [mm]	a _c min [mm]	a _x grid [mm]	nr min
A	3.5	7	5	-	2
B	8	8	6	2	2
B_i [mm] 25 38 58 78 103 130					
a_T min [mm] 8.5 9 9 9 7.5 9					

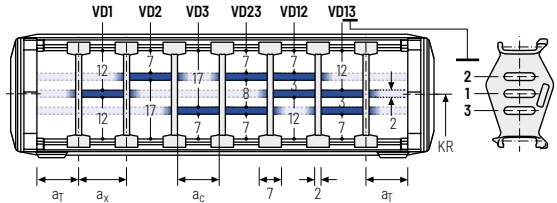

Order example



TS1	.	A	.	3	-	V00
⋮						
						V01
Divider system		Version		nr		Height separation

Please state the designation of the divider system (**TS0, TS1...**), version and number of dividers per cross section [nr].

If using divider systems with height separation (**TS1**) please also state the positions [e.g. VD1] viewed from the left driver belt. You are welcome to add a sketch to your order.

Universal end connectors UMB – plastic (standard)

The universal end connectors (UMB) are made from plastic and can be mounted from the top, from the bottom, or face on.

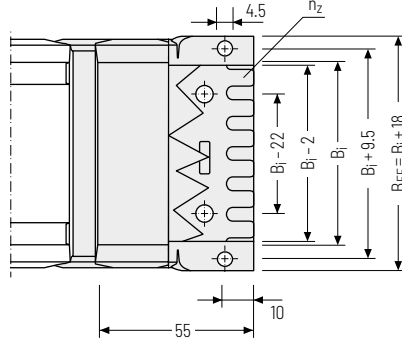
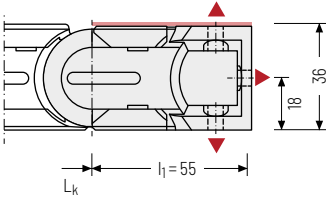

▲ Assembly options

Recommended tightening torque: 3 Nm for cheese-head screws ISO 4762 - M4 x 20

B_i [mm]	B_{EF} [mm]	n_z
25	43	2
38	56	3
58	76	5
78	96	7
103	121	9
130	148	11

The end connectors are also available as an option **without** cover sheets. Please state when ordering.

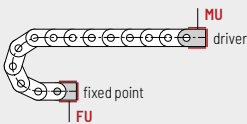

Connection point
F - fixed point
M - driver

Connection type
U - Universal mounting bracket

Order example

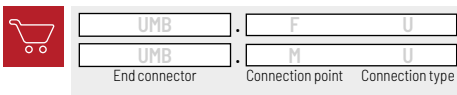

PROTUM® series
K series
UNIFLEX Advanced series
M series
XL series
QUANTUM® series
TKR series
TKA series
UAT series

TKA45



Pitch
45.5 mm



Inner height
36 mm



Inner widths
50 – 150 mm



Bending radii
82 – 230 mm

Stay variants



Design 060 page **560**

Covered on both sides with inside detachable cover

- » Plastic cover for rough environmental conditions with dirt, chips or spray water.
- » Fully detachable on one side in any position.
- » **Inside:** very quick release.



Design 080 page **561**

Covered on both sides with outside detachable cover

- » Plastic cover for rough environmental conditions with dirt, chips or spray water.
- » Fully detachable on one side in any position.
- » **Outside:** very quick release.

Unsupported arrangement

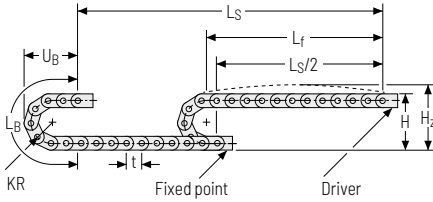

KR [mm]	H [mm]	H _z [mm]	L _B [mm]	U _B [mm]
82	214	249	348	153
95	240	275	389	166
125	300	335	483	196
145	340	375	546	216
170	390	425	625	241
200	450	485	719	271
230	520	555	814	301

Load diagram for unsupported length depending on the additional load.

Sagging of the cable carrier is technically permitted for extended travel lengths, depending on the specific application.

Intrinsic cable carrier weight $q_k = 2.29 \text{ kg/m}$ at B_i 150 mm. For other inner widths, the maximum additional load changes.

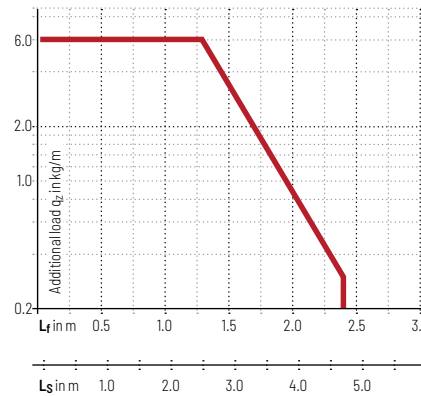

Speed
up to 9 m/s

Acceleration
up to 45 m/s²

Travel length
up to 4.7 m

Additional load
up to 6 kg/m

Gliding arrangement

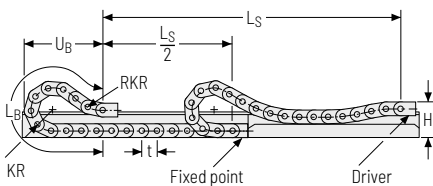

Speed
up to 3 m/s

Acceleration
up to 20 m/s²

Travel length
up to 125 m

Additional load
up to 6 kg/m

The gliding cable carrier has to be routed in a channel. See p. 844.

Stay variant 060 – covered on both sides with inside detachable cover

- » Plastic cover for rough environmental conditions with dirt, chips or spray water.
- » Fully detachable on one side in any position.
- » **Inside:** very quick release.



Stay arrangement on each chain link (**VS: fully-stayed**)



B_i : 50 – 150 mm

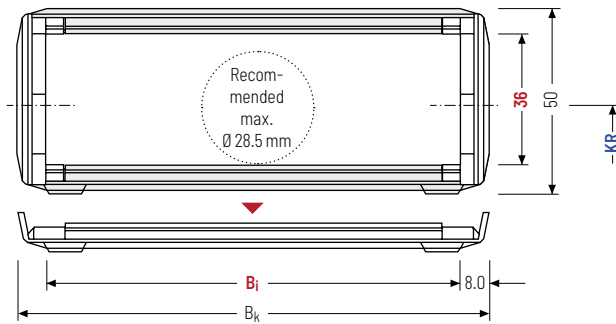

The maximum cable diameter strongly depends on the bending radius and the desired cable type. Please contact us.

Calculating the cable carrier length

Cable carrier length L_k

$$L_k \approx \frac{L_S}{2} + L_B$$

Cable carrier length L_k
rounded to pitch t

h_i [mm]	h_G [mm]	B_i [mm]			B_k [mm]	KR [mm]					q_k [kg/m]				
36	51	50	75	100	125	150	$B_i + 16$	82	95	125	145	170	200	230	1.34 – 2.29

Order example



TKA45

Type

060

Stay variant

125

 B_i [mm]

170

KR [mm]

1456

 L_k [mm]

VS

Stay arrangement

Stay variant 080 – covered on both sides with outside detachable cover

- » Plastic cover for rough environmental conditions with dirt, chips or spray water.
- » Fully detachable on one side in any position.
- » **Outside:** very quick release.



 Stay arrangement on each chain link (**VS: fully-stayed**)

 B_k 50 – 150 mm

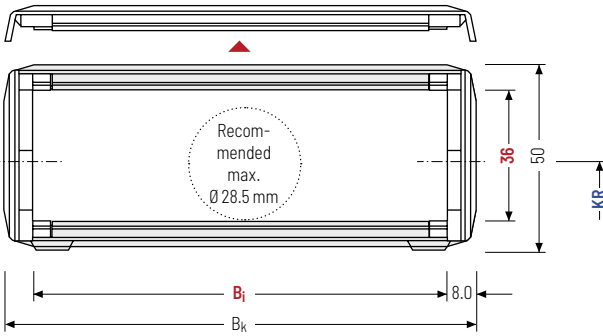

 The maximum cable diameter strongly depends on the bending radius and the desired cable type. Please contact us.

Calculating the cable carrier length

Cable carrier length L_k

$$L_k \approx \frac{L_S}{2} + L_B$$

Cable carrier length L_k rounded to pitch t

h_i [mm]	h_g [mm]	B_i [mm]			B_k [mm]	KR [mm]					q_k [kg/m]				
36	51	50	75	100	125	150	$B_i + 16$	82	95	125	145	170	200	230	1.34 - 2.29

Order example

 **TKA45** . **080** . **125** . **170** . **1456** . **VS**
 Type Stay variant B_i [mm] KR [mm] L_k [mm] Stay arrangement

Divider systems

The divider system is mounted on every 2nd chain link as a standard.

As a standard, dividers or the complete divider system (dividers with height separations) are movable in the cross section (**version A**).

The dividers are easily attached to the stay for applications with transverse accelerations and for applications laying on the side by simply turning them.

The locking cams click into place in the locking grids in the covers (**version B**).

Divider system TSO without height separation

Vers.	a _T min [mm]	a _x min [mm]	a _c min [mm]	a _x grid [mm]	η _T min
A	4	8	5.5	-	-
B	↑	8	5.5	2	-

B _i [mm]	50	75	100	125	150
a _T min [mm]	11	11.5	12	12.5	11

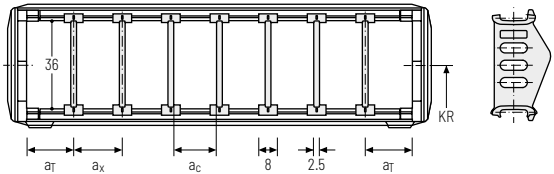

Divider system TS1 with continuous height separation

Vers.	a _T min [mm]	a _x min [mm]	a _c min [mm]	a _x grid [mm]	η _T min
A	4	8	5.5	-	2
B	↑	8	5.5	2	2

B _i [mm]	50	75	100	125	150
a _T min [mm]	11	11.5	12	12.5	11

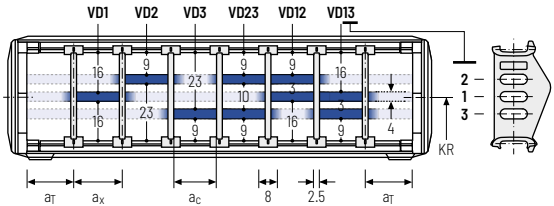

Order example



TS1	.	A	.	3	-	V00
						⋮
						V01

Divider system Version η_T Height separation

Please state the designation of the divider system (**TS0, TS1...**), version and number of dividers per cross section [η_T].

If using divider systems with height separation (**TS1**) please also state the positions [e.g. VD1] viewed from the left driver belt. You are welcome to add a sketch to your order.

Divider system TS3 with height separation consisting of plastic partitions

As a standard, the divider **A** is used for vertical partitioning within the cable carrier. The complete divider system can be moved within the cross section. (**version A**).

The dividers are easily attached to the stay for applications with transverse accelerations and for applications laying on the side by simply turning them. The locking cams click into place in the locking grids in the covers (**version B**).

Divider version A

End divider



Vers.	a _T min [mm]	a _x min [mm]	a _c min [mm]	n _T min
A	4/2*	14	10	2

* For End divider

The dividers are fixed by the partitions. the complete divider system is movable in the cross section.

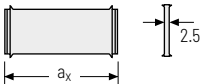
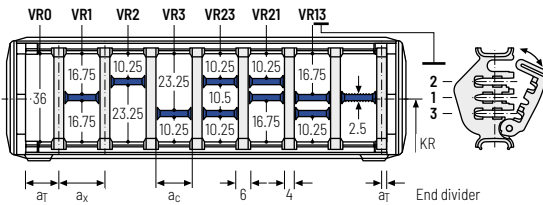

a _x (center distance of dividers) [mm]																
a _c (nominal width of inner chamber) [mm]																
14	16	19	23	24	28	29	32	33	34	38	39	43	44	48	49	54
10	12	15	19	20	24	25	28	29	30	34	35	39	40	44	45	50
58	59	64	68	69	74	78	79	80	84	88	89	94	96	99	112	
54	55	60	64	65	70	74	75	76	80	84	85	90	92	95	108	

When using partitions with a_x > 49 mm we recommend an additional preferential central support.

Order example

🛒

TS3

A

3

K1

34

VR1

⋮
 ⋮
 ⋮

K4

38

VR3

Divider system

Version

n_T

Chamber

a_x

Height separation

Please state the designation of the divider system (**TS0, TS1...**), version and number of dividers per cross section [n_T]. In addition, please also enter the chambers [K] from left to right, as well as the assembly distances [a_T/a_x] (as seen from the driver).

If using divider systems with height separation (**TS1, TS3**) please also state the positions [e.g. VD23] viewed from the left driver belt. You are welcome to add a sketch to your order.

PROTUM® series

K series

UNIFLEX Advanced series

M series

XL series

QUANTUM® series

TKR series

TKA series

UAT series

UAT
series

TKA
series

TKR
series

QUANTUM®
series

XL
series

M
series

UNIFLEX
Advanced
series

K
series

PROTUM®
series



Universal end connectors UMB – plastic (standard)

The universal end connectors (UMB) are made from plastic and can be mounted from the top, from the bottom, or face on.

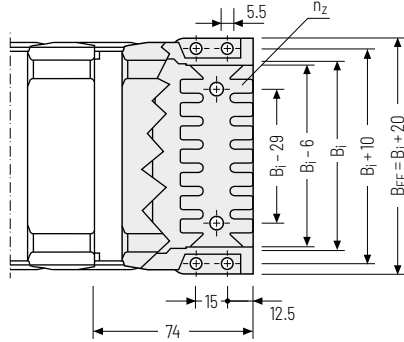
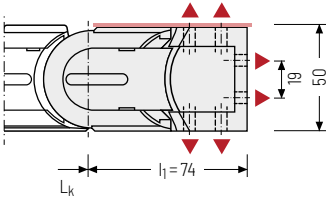

▲ Assembly options

Recommended tightening torque: 5 Nm for cheese-head screws ISO 4762 - M5 x 8.8

B_i [mm]	B_{EF} [mm]	n_z
50	70	2 x 3
75	95	2 x 5
100	120	2 x 7
125	145	2 x 9
150	170	2 x 11

The end connectors are also available as an option **without** cover sheets. Please state when ordering.

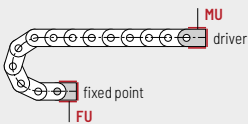

Connection point
F - fixed point
M - driver

Connection type
U - Universal mounting bracket

Order example

	UMB	.	F	U
	UMB	.	M	U
	End connector		Connection point	Connection type

PROTUM® series
K series
UNIFLEX Advanced series
M series
XL series
QUANTUM® series
TKR series
TKA series
UAT series

TKA55

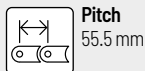

Pitch
55.5 mm



Inner height
45 mm



Inner widths
50 – 250 mm



Bending radii
100 – 300 mm

Stay variants



Design 060 page **568**

Covered on both sides with inside detachable cover

- » Plastic cover for rough environmental conditions with dirt, chips or spray water.
- » Fully detachable on one side in any position.
- » **Inside:** very quick release.



Design 080 page **569**

Covered on both sides with outside detachable cover

- » Plastic cover for rough environmental conditions with dirt, chips or spray water.
- » Fully detachable on one side in any position.
- » **Outside:** very quick release.

Unsupported arrangement

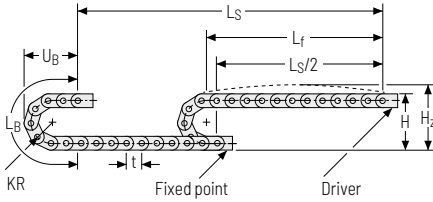

KR [mm]	H [mm]	H _z [mm]	L _B [mm]	U _B [mm]
100	264	304	425	188
120	304	344	488	208
140	344	384	551	228
170	404	454	645	258
195	454	494	725	283
225	514	554	818	313
250	564	604	896	338
300	664	704	1211	388

Load diagram for unsupported length depending on the additional load.

Sagging of the cable carrier is technically permitted for extended travel lengths, depending on the specific application.

Intrinsic cable carrier weight $q_k = 1.95 \text{ kg/m}$ at B_i 50 mm. For other inner widths, the maximum additional load changes.

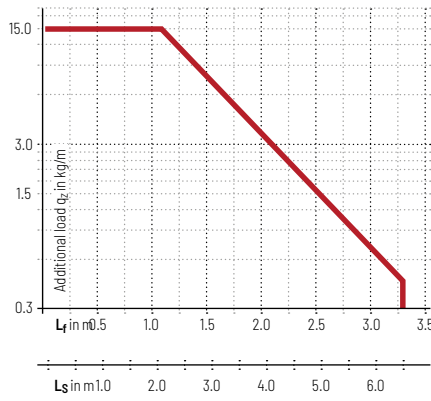

Speed
up to 8 m/s

Acceleration
up to 40 m/s²

Travel length
up to 6.5 m

Additional load
up to 15 kg/m

Gliding arrangement

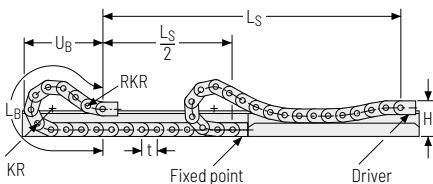

Speed
up to 3 m/s

Acceleration
up to 15 m/s²

Travel length
up to 150 m

Additional load
up to 15 kg/m

The gliding cable carrier has to be routed in a channel. See p. 844.

Stay variant 060 – covered on both sides with inside detachable cover

- » Plastic cover for rough environmental conditions with dirt, chips or spray water.
- » Fully detachable on one side in any position.
- » **Inside:** very quick release.



Stay arrangement on each chain link (**VS: fully-stayed**)



B_i : 50 – 250 mm

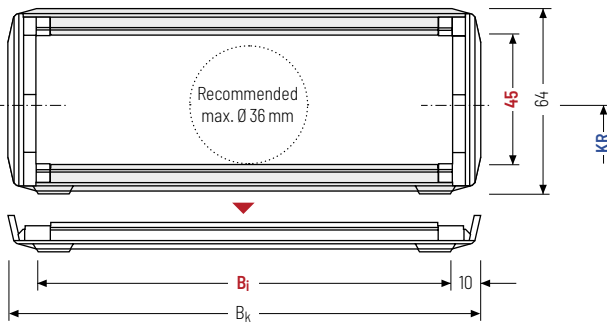

The maximum cable diameter strongly depends on the bending radius and the desired cable type. Please contact us.

Calculating the cable carrier length

Cable carrier length L_k

$$L_k \approx \frac{L_S}{2} + L_B$$

Cable carrier length L_k rounded to pitch t

h_i [mm]	h_g [mm]	B_i [mm]					B_k [mm]	KR [mm]				q_k [kg/m]
45	65	50	75	100	125	150	$B_i + 20$	100	120	140	170	1,95
		175	200	225	250	195		225	250	300	4,28	

Order example



TKA55

Type

060

Stay variant

200

B_i [mm]

225

KR [mm]

2553

L_k [mm]

VS

Stay arrangement

Stay variant 080 – covered on both sides with outside detachable cover

- » Plastic cover for rough environmental conditions with dirt, chips or spray water.
- » Fully detachable on one side in any position.
- » **Outside:** very quick release.



Stay arrangement on each chain link (**VS: fully-stayed**)

B_i : 50 – 150 mm

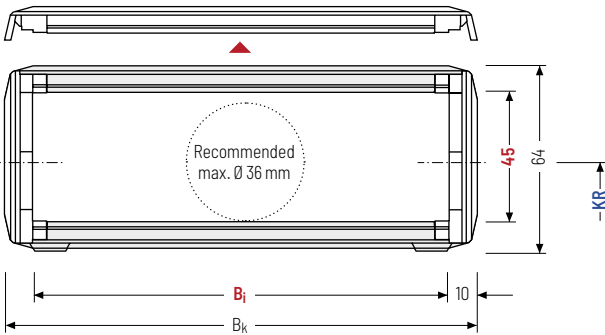

The maximum cable diameter strongly depends on the bending radius and the desired cable type. Please contact us.

Calculating the cable carrier length

Cable carrier length L_k

$$L_k \approx \frac{L_S}{2} + L_B$$

Cable carrier length L_k rounded to pitch t

h_i [mm]	h_g [mm]	B_i [mm]					B_k [mm]	KR [mm]				q_k [kg/m]
45	65	50	75	100	125	150	$B_i + 20$	100	120	140	170	1,95
		175	200	225	250	195		225	250	300	4,28	

Order example

TKA55 (Type) · **080** (Stay variant) · **200** (B_i [mm]) · **225** (KR [mm]) · **2553** (L_k [mm]) · **VS** (Stay arrangement)

Divider systems

As a standard, the divider system is mounted on every 2nd chain link.

As a standard, dividers or the complete divider system (dividers with height separations) are movable in the cross section (**version A**).

The dividers are easily attached to the stay for applications with transverse accelerations and for applications laying on the side by simply turning them.

The locking cams click into place in the locking grids in the covers (**version B**).

Divider system TSO without height separation

Vers.	a_T min [mm]	a_X min [mm]	a_C min [mm]	a_X grid [mm]	n_T min
A	5	10	7	-	-
B		10	7	2	-

B_i [mm]	50	75	100	125	150
a_T min [mm]	13	11.5	12	12.5	13
B_i [mm]	175	200	225	250	
a_T min [mm]	11.5	12	12.5	13	

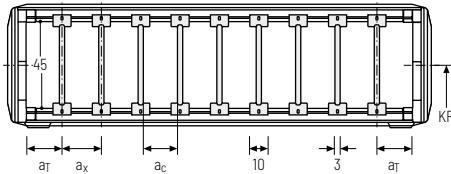

Divider system TS1 with continuous height separation

Vers.	a_T min [mm]	a_X min [mm]	a_C min [mm]	a_X grid [mm]	n_T min
A	5	10	7	-	2
B		10	7	2	2

B_i [mm]	50	75	100	125	150
a_T min [mm]	13	11.5	12	12.5	13
B_i [mm]	175	200	225	250	
a_T min [mm]	11.5	12	12.5	13	

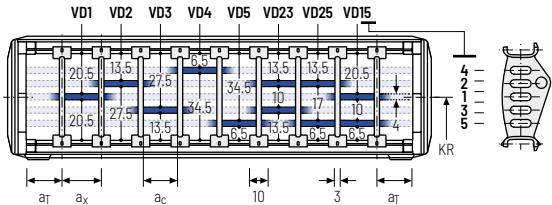

Order example



TS1	.	A	.	3	-	V00
						⋮
						V01
Divider system		Version		n_T		Height separation

Please state the designation of the divider system (**TS0, TS1...**), version and number of dividers per cross section [n_T].

If using divider systems with height separation (**TS1**) please also state the positions [e.g. VD1] viewed from the left driver belt. You are welcome to add a sketch to your order.

Divider system TS3 with height separation consisting of plastic partitions

As a standard, the divider **A** is used for vertical partitioning within the cable carrier. The complete divider system can be moved within the cross section. (**version A**).

The dividers are easily attached to the stay for applications with transverse accelerations and for applications laying on the side by simply turning them. The locking cams click into place in the locking grids in the covers (**version B**).

Divider version A

End divider

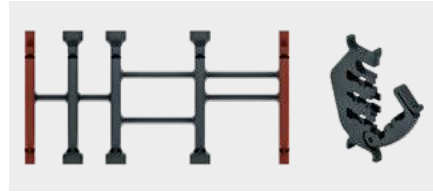

Vers.	a _T min [mm]	a _x min [mm]	a _c min [mm]	n _T min
A	4 / 2*	14	10	2

* For End divider

The dividers are fixed by the partitions. the complete divider system is movable in the cross section.

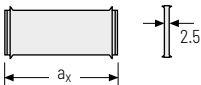
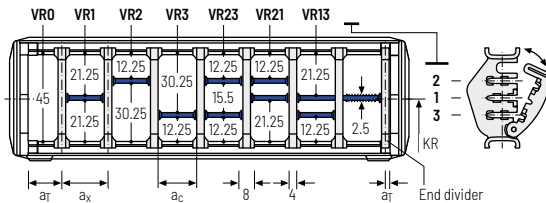

a _x (center distance of dividers) [mm]																
a _c (nominal width of inner chamber) [mm]																
14	16	19	23	24	28	29	32	33	34	38	39	43	44	48	49	54
10	12	15	19	20	24	25	28	29	30	34	35	39	40	44	45	50
58	59	64	68	69	74	78	79	80	84	88	89	94	96	99	112	
54	55	60	64	65	70	74	75	76	80	84	85	90	92	95	108	

When using partitions with a_x > 49 mm we recommend an additional preferential central support.

Order example



TS3	A	3	K1	34	VR1
			⋮	⋮	⋮
			K4	38	VR3
Divider system	Version	n _T	Chamber	a _x	Height separation

Please state the designation of the divider system (**TS0, TS1...**). version and number of dividers per cross section [n_T]. In addition, please also enter the chambers [K] from left to right, as well as the assembly distances [a_T/a_x] (as seen from the driver).

If using divider systems with height separation (**TS1, TS3**) please also state the positions [e.g. VD23] viewed from the left driver belt. You are welcome to add a sketch to your order.

PROTUM® series
K series
UNIFLEX Advanced series
M series
XL series
QUANTUM® series
TKR series
TKA series
UAT series

PROTUM®
series

K
series

UNIFLEX
Advanced
series

M
series

XL
series

QUANTUM®
series

TKR
series

TKA
series

UAT
series



Universal end connectors UMB – plastic (standard)

The universal end connectors (UMB) are made from plastic and can be mounted from the top, from the bottom, or face on.

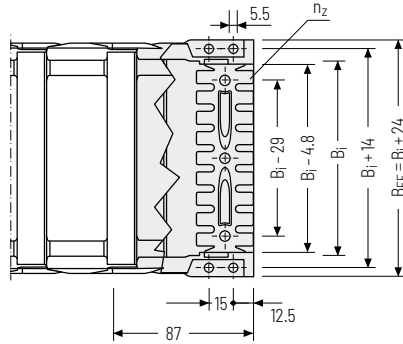
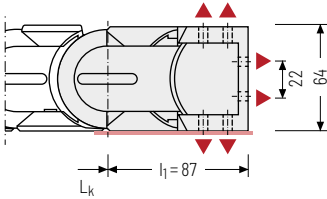

▲ Assembly options

Recommended tightening torque: 5 Nm for cheese-head screws ISO 4762 - M5 x 8.8

B_i [mm]	B_{EF} [mm]	n_z
50	74	2 x 3
75	99	2 x 5
100	124	2 x 7
125	149	2 x 9
150	174	2 x 11
175	199	2 x 13
200	224	-
225	249	-
250	274	-

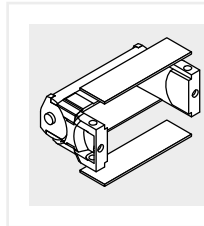

The end connectors are also available as an option **without** cover sheets. Please state when ordering.

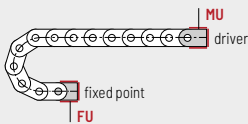

Connection point
F - fixed point
M - driver

Connection type
U - Universal mounting bracket

Order example

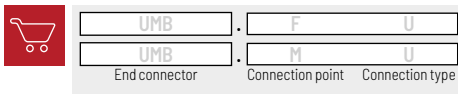

PROTUM® series
K series
UNIFLEX Advanced series
M series
XL series
QUANTUM® series
TKR series
TKA series
UAT series

UAT series

Extreme cable protection in harsh environmental conditions

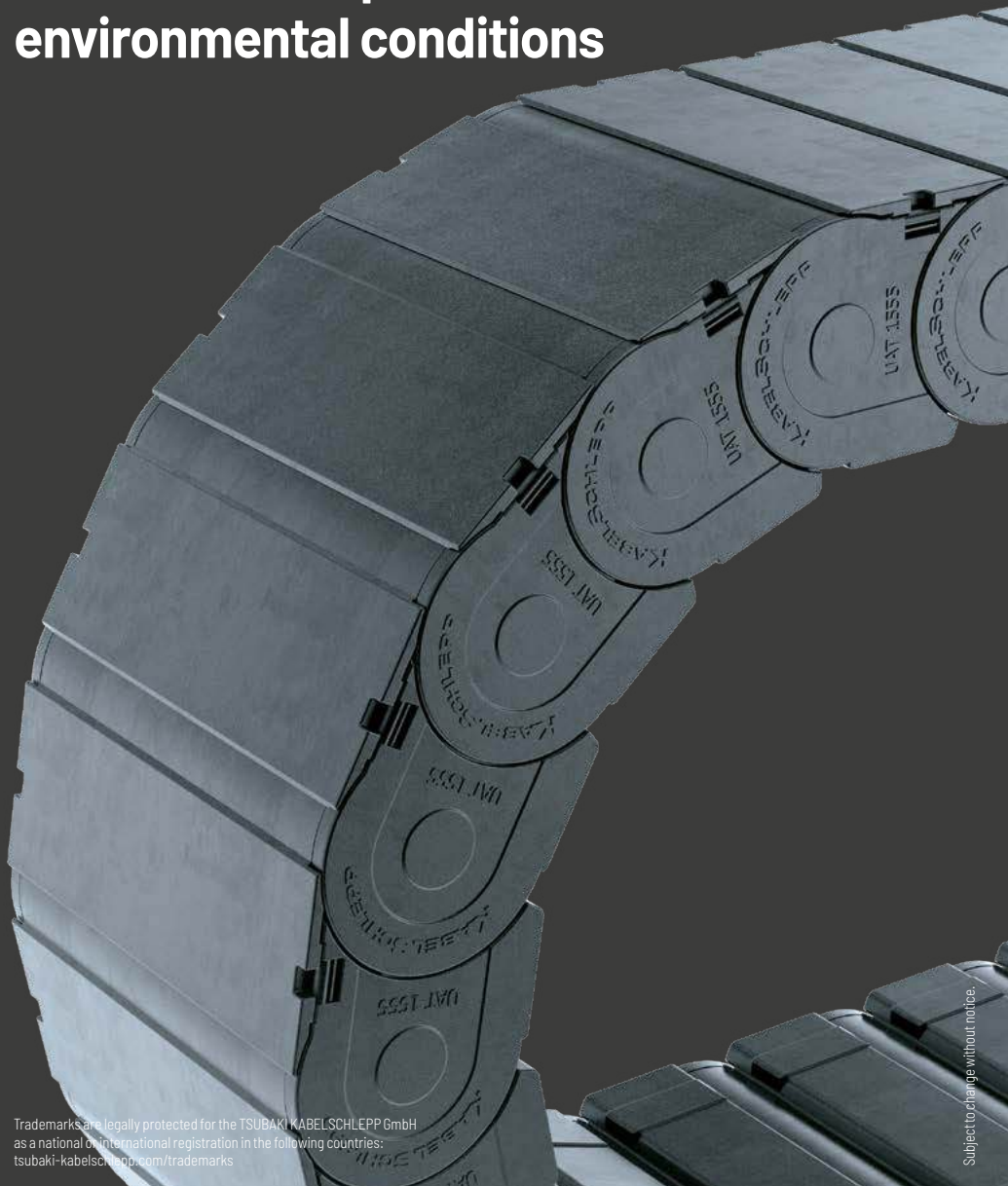

Trademarks are legally protected for the TSUBAKI KABELSCHLEPP GmbH as a national or international registration in the following countries:
tsubaki-kabelschlepp.com/trademarks

Subject to change without notice.

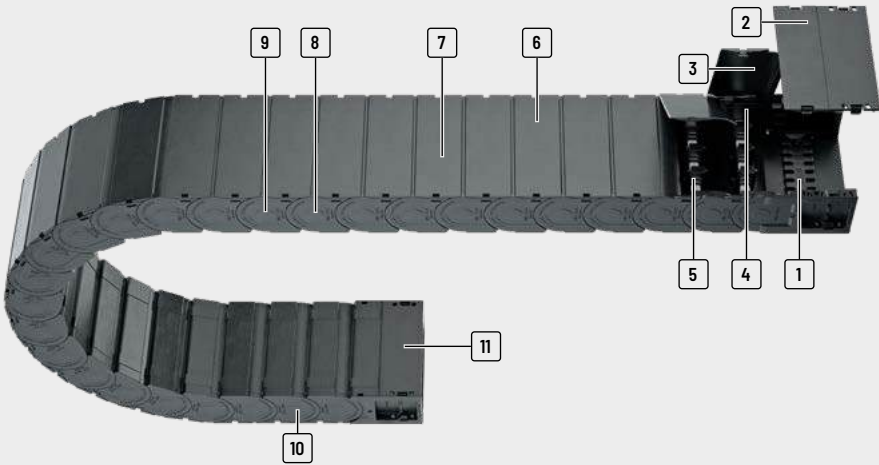

- 1 Connectors with optional strain relief
- 2 Completely detachable covers
- 3 Easy and quick to open
- 4 Gentle on the cables – interior space without projecting edges
- 5 Dividers and height separations for cable separation
- 6 Designs with outward opening covers
- 7 Secure hold of the covers also under heavy load (e.g. by the use of hydraulic cables)
- 8 Chain links made of plastic
- 9 Extensive unsupported length
- 10 Very quiet thanks to integrated noise damping system
- 11 Cover system also in the connection

Features

- » outstanding protection for the cables
- » quick cable laying – outside opening designs
- » very quiet thanks to internal noise damping system
- » large unsupported length
- » high-quality visual design
- » for unsupported and gliding arrangements
- » sliding surfaces with wear volume integrated in the inner cover

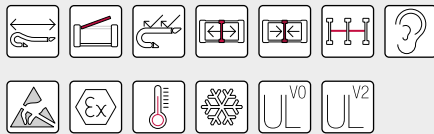

Simply unlock cover with a screwdriver



Detach the cover from the chain link



Divider system TS1



Optional strain relief comb – also placed on top of one another

PROTUM®
series

K
series

UNIFLEX
Advanced
series

M
series

XL
series

QUANTUM®
series

TKR
series

TKA
series

UAT
series

Type	Opening variant	Stay variant	h_i [mm]	h_G [mm]	B_i [mm]	B_k [mm]	B_i - grid [mm]	t [mm]	KR [mm]	Additional load \leq [kg/m]	Cable- d_{max} [mm]
UAT1555											
		080	50	69	75 - 175	Bi + 21	-	55.5	100 - 300	15	40

PROTUM®
seriesK
seriesUNIFLEX
Advanced
seriesM
seriesXL
seriesQUANTUM®
seriesTKR
seriesTKA
seriesUAT
series

Unsupported arrangement			Gliding arrangement			Inner Distribution				Movement			Page
Travel length ≤ [m]	v_{max} ≤ [m/s]	a_{max} ≤ [m/s ²]	Travel length ≤ [m]	v_{max} ≤ [m/s]	a_{max} ≤ [m/s ²]	TS0	TS1	TS2	TS3	vertical hanging or standing	lying on the side	rotating arrangement	

6.5	8	40	150	3	15	•	•	-	-	•	•	-	578
-----	---	----	-----	---	----	---	---	---	---	---	---	---	-----

PROTUM® series
K series
UNIFLEX Advanced series
M series
XL series
QUANTUM® series
TKR series
TKA series

Subject to change without notice.

UAT1555



Pitch
55.5 mm



Inner height
50 mm



Inner widths
75 – 175 mm



Bending radii
100 – 300 mm

Stay variants



Design 080 page **580**

Covered on both sides with outside detachable cover

- » Plastic cover for rough environmental conditions with dirt, chips and dust.
- » Fully detachable on one side in any position.
- » **Inside:** very quick release.

Unsupported arrangement

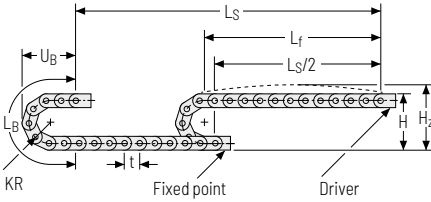





KR [mm]	H [mm]	H ₂ [mm]	L _B [mm]	U _B [mm]
100	268	298	425	190
125	318	348	504	215
150	368	398	582	240
175	418	448	661	265
200	468	498	739	290
225	518	548	818	315
250	568	598	896	340
300	668	698	1053	390

Load diagram for unsupported length depending on the additional load.

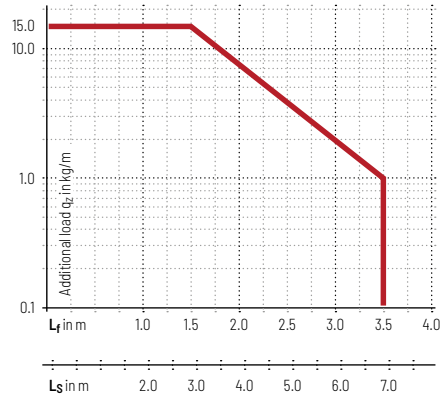
Sagging of the cable carrier is technically permitted for extended travel lengths, depending on the specific application.





Intrinsic cable carrier weight $q_k = 2.9 \text{ kg/m}$ at B; 125 mm. For other inner widths, the maximum additional load changes.

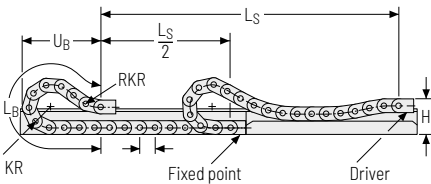

-  **Speed**
up to 8 m/s
-  **Acceleration**
up to 40 m/s²
-  **Travel length**
up to 6.5 m
-  **Additional load**
up to 15 kg/m

Gliding arrangement



-  **Speed**
up to 3 m/s
-  **Acceleration**
up to 15 m/s²
-  **Travel length**
up to 150 m
-  **Additional load**
up to 15 kg/m

 The gliding cable carrier has to be routed in a channel. See p. 844.

Stay variant 080 – covered on both sides with inside detachable cover

- » Plastic cover for rough environmental conditions with dirt and chips.
- » Fully detachable on one side in any position.
- » **Inside:** very quick release.



Stay arrangement on each chain link (**VS: fully-stayed**)



B_i 75 – 175 mm

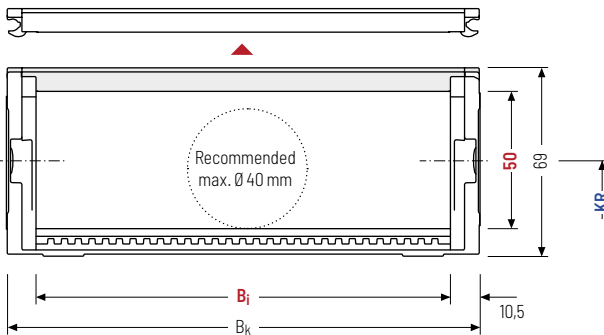

The maximum cable diameter strongly depends on the bending radius and the desired cable type. Please contact us.

Calculating the cable carrier length

Cable carrier length L_k

$$L_k \approx \frac{L_S}{2} + L_B$$

Cable carrier length L_k rounded to pitch t

h_i [mm]	h_G [mm]	B_i [mm]			B_k [mm]	KR [mm]				q_k [kg/m]
50	69	75	125	175	$B_i + 21$	100	125	150	175	2.43
						200	225	250	300	3.44

Order example



UAT1555

Type

080

Stay variant

175

B_i [mm]

225

KR [mm]

2553

L_k [mm]

VS

Stay arrangement

UAT
seriesTKA
seriesTKR
seriesQUANTUM®
seriesXL
seriesM
seriesUNIFLEX
Advanced
seriesK
seriesPROTUM®
series

Universal end connectors UMB – plastic (standard)

The universal end connectors (UMB) are made from plastic and can be mounted from the top, from the bottom, or face on.

Driver

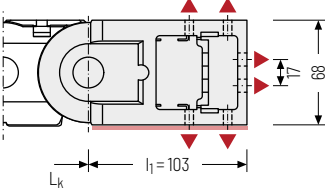

Fixed point

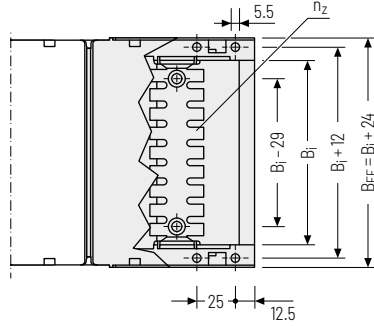
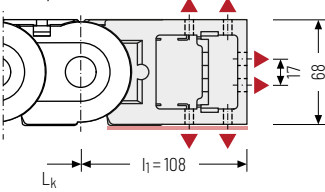

▲ Assembly options

B_1 [mm]	B_{EF} [mm]	n_2
75	99	2 x 5
125	149	2 x 9
175	199	2 x 13

Recommended tightening torque:
5 Nm for cheese-head screws ISO 4762 - M5 x 8.8

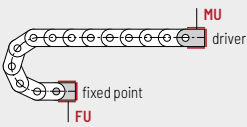

Connection point
F - fixed point
M - driver

Connection type
U - Universal mounting bracket

Order example

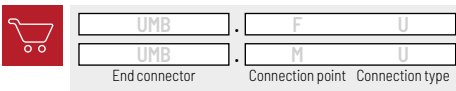

PROTUM® series
K series
UNIFLEX Advanced series
M series
XL series
QUANTUM® series
TKR series
TKA series

MT series

Variable, closed cable carrier with
extensive range of accessories



Trademarks are legally protected for the TSUBAKI KABELSCHLEPP GmbH
as a national or international registration in the following countries:
tsubaki-kabelschlepp.com/trademarks

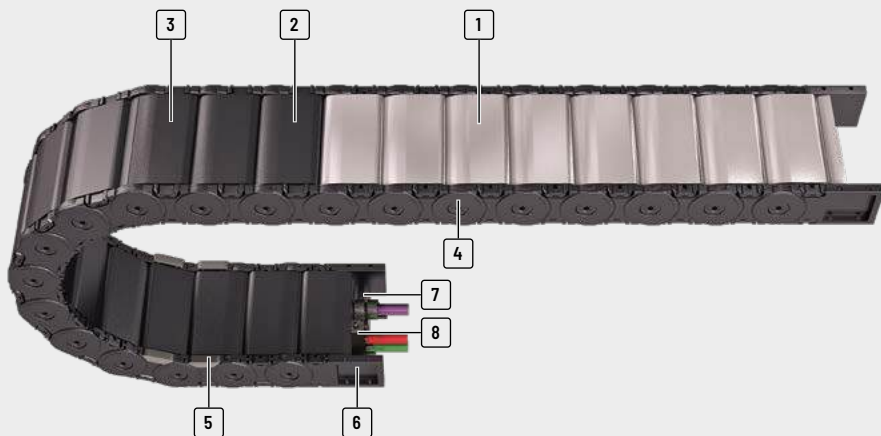

- | | | |
|--|--|---|
| <p>1 Aluminum cover available in 1 mm width sections</p> <p>2 Plastic cover available in 8 or 16 mm width sections</p> | <p>3 Can be opened quickly on the inside and the outside for cable laying</p> <p>4 Locking bolts</p> <p>5 Replaceable glide shoes</p> | <p>6 Universal end connectors (UMB)</p> <p>7 C-rail for strain relief elements</p> <p>8 Strain relief elements</p> |
|--|--|---|

Features

- » Encapsulated, dirt-resistant stroke system
 - » Stable side bands through robust link plate design
 - » Easy assembly of side bands through bars with easy-to-assemble locking bolts
 - » Long service life due to minimized hinge wear owing to the "life extending 2 disc principle"
 - » Large selection of vertical and horizontal stay systems and separation options for your cables
- » Versions with aluminum cover system available in 1 mm width sections up to 800 mm inner width
 - » Versions with plastic cover system available in 8 or 16 mm width sections

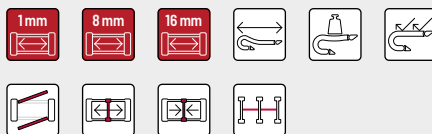

Minimized hinge wear owing to the "life extending 2 disc principle"



Sturdy link plate design, encapsulated stroke system



Easy to assemble through locking bolts



Replaceable glide shoes for long service life for gliding applications

Type	Opening variant	Stay variant	h_i	h_G	B_i	B_k	B_i -grid	t	KR	Additional load \leq [kg/m]	Cable- d_{max} [mm]
			[mm]	[mm]	[mm]	[mm]	[mm]	[mm]	[mm]		
MT0475											
		RMD 01	26	39	33 - 180	41 - 197	1	47.5	75 - 300	3	20
		RMD 02	26	39	33 - 180	41 - 197	1	47.5	75 - 300	3	20
		RDD 01	26	39	24 - 280	41 - 297	8	47.5	75 - 300	3	20
		RDD 02	26	39	24 - 280	41 - 297	8	47.5	75 - 300	3	20
MT0650											
		RMD	38.5	57	100 - 500	134 - 534	1	65	115 - 350	25	30
		RDD	38.5	57	50 - 258	84 - 292	8	65	95 - 350	25	30
MT0950											
		RMD	54.5	80	100 - 600	139 - 639	1	95	200 - 380	35	43
		RDD	54.5	80	77 - 349	116 - 388	16	95	140 - 380	35	43
MT1250											
		RMD	68.5	96	150 - 800	195 - 845	1	125	260 - 500	65	61
		RDD	68.5	96	103 - 359	148 - 404	16	125	220 - 500	65	61
MT1300											
		RMD	87	120	100 - 800	150 - 850	1	130	240 - 500	70	69

Unsupported arrangement			Gliding arrangement			Inner Distribution				Movement			Page
Travel length ≤ [m]	$v_{max} \leq [m/s]$	$a_{max} \leq [m/s^2]$	Travel length ≤ [m]	$v_{max} \leq [m/s]$	$a_{max} \leq [m/s^2]$	TS0	TS1	TS2	TS3	vertical hanging or standing	lying on the side	rotating arrangement	
2.7	10	50	-	-	-	•	•	-	-	•	•	-	590
2.7	10	50	-	-	-	•	•	-	-	•	•	-	592
2.7	10	50	-	-	-	•	•	•	-	•	•	-	594
2.7	10	50	-	-	-	•	•	•	-	•	•	-	596
4.8	10	35	170	8	20	•	•	-	-	•	•	-	602
4.8	10	35	170	8	20	•	•	-	-	•	•	-	604
7.4	10	25	230	8	20	•	•	•	-	•	•	-	610
7.4	10	25	230	8	20	•	•	•	•	•	•	-	612
9.7	10	20	270	8	20	•	•	•	-	•	•	-	618
9.7	10	20	270	8	20	•	•	•	•	•	•	-	620
10.8	10	20	300	8	20	•	•	-	•	•	•	-	626

Subject to change without notice.

MT series

XLT series

ROBOTRAX® System

FLATVEYOR®

CLEANVEYOR®

LS/LSX series

S/SX series

S/SX-Tubes series

Accessories

TRAXLINE®

MT0475



Pitch
47.5 mm



Inner height
26 mm



Inner widths
24 - 280 mm



Bending radii
75 - 300 mm

XLT
seriesROBOTRAX®
System

FLATVEYOR®

CLEANVEYOR®

LS/LSX
seriesS/SX
seriesS/SX-Tubes
series

Accessories

TRAXLINE®

Stay variants



Aluminum cover RMD 01 page 590

Cover with hinge in the inner radius

- » Aluminum cover system with hinge for light and medium loads. Assembly without screws.
- » **Outside:** release by rotating 90°.
- » **Inside:** swivable to both sides.



Aluminum cover RMD 02 page 592

Cover with hinge in the outer radius

- » Aluminum cover system with hinge for light and medium loads. Assembly without screws.
- » **Outside:** swivable to both sides.
- » **Inside:** release by turning by 90°.



Plastic cover RDD 01 page 594

Cover with hinge in the inner radius

- » Plastic cover system with hinge for light and medium loads. Assembly without screws.
- » **Outside:** release by rotating 90°.
- » **Inside:** swivable to both sides.



Plastic cover RDD 02 page 596

Cover with hinge in the outer radius

- » Plastic cover system with hinge for light and medium loads. Assembly without screws.
- » **Outside:** swivable to both sides.
- » **Inside:** release by turning by 90°.

Unsupported arrangement

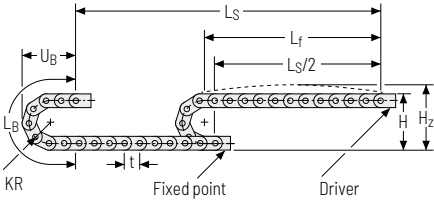

KR [mm]	H [mm]	H _z [mm]	L _B [mm]	U _B [mm]
75	189	214	331	142
100	239	264	410	167
130	299	324	504	197
160	359	384	598	227
200	439	464	724	267
250	539	564	881	317
300	639	664	1038	367

Load diagram for unsupported length

depending on the additional load.

Sagging of the cable carrier is technically permitted for extended travel lengths, depending on the specific application.

Intrinsic cable carrier weight $q_k = 1.7 \text{ kg/m}$. For other inner widths, the maximum additional load changes.

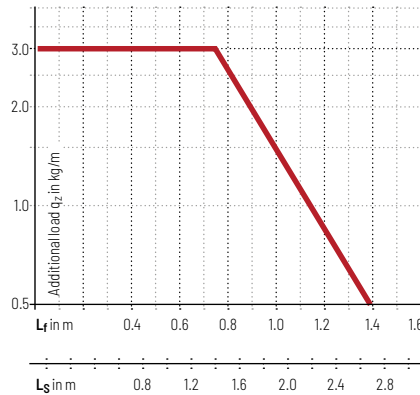

Speed
up to 10 m/s

Acceleration
up to 50 m/s²

Travel length
up to 2.7 m

Additional load
up to 3.0 kg/m

MT series

XLT series

ROBOTRAX® System

FLATVEVOR®

CLEANVEVOR®

LS/LSX series

S/SX series

S/SX-Tubes series

Accessories

TRAXLINE®

Aluminum cover RMD 01 – cover with hinge in the inner radius

- » Aluminum cover system with hinge for light and medium loads. Assembly without screws.
- » Available customized in **1 mm sections**.
- » **Outside:** release by turning 90°.
- » **Inside:** swivable to both sides.



Stay arrangement on each chain link (**VS: fully-stayed**)



1 mm B_i 33 – 180 mm
in 1 mm width sections

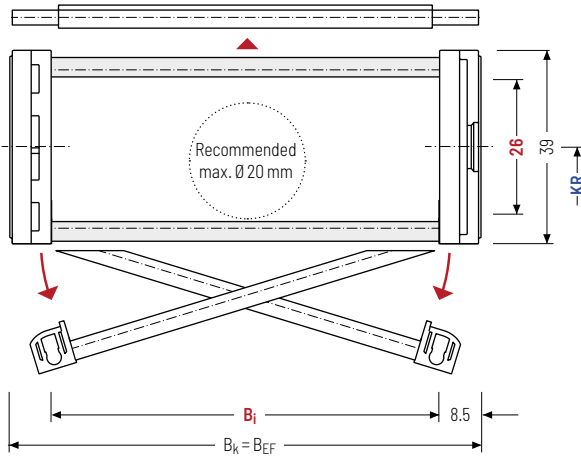

The maximum cable diameter strongly depends on the bending radius and the desired cable type. Please contact us.

Calculating the cable carrier length

Cable carrier length L_k

$$L_k \approx \frac{L_S}{2} + L_B$$

Cable carrier length L_k
rounded to pitch t

h_i [mm]	h_g [mm]	B_i [mm]*	B_k [mm]	B_{EF} [mm]	KR [mm]				q_k [kg/m]
26	39	33 – 180	$B_i + 17$	$B_i + 17$	75	100	130	160	1.40 – 4.92
					200	250	300		

* in 1 mm width sections

Order example



MT0475

Type

128

B_i [mm]

RMD 01

Stay variant

100

KR [mm]

1425

L_k [mm]

VS

Stay arrangement

Divider systems

As a standard, the divider system is mounted on every 2nd chain link.

As a standard, dividers or the complete divider system (dividers with height separations) are movable in the cross section (**version A**).

Divider system TSO without height separation

Vers.	a _T min [mm]	a _x min [mm]	a _c min [mm]	n _T min
A	6	7.8	5	-

The dividers can be moved in the cross section.

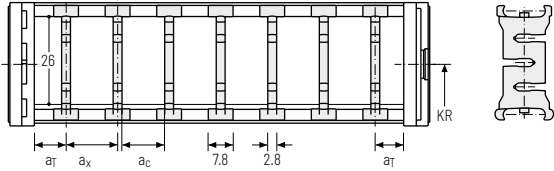

Divider system TS1 with continuous height separation

Vers.	a _T min [mm]	a _T max [mm]	a _x min [mm]	a _c min [mm]	n _T min
A	6	20	7.8	5	2

The dividers can be moved in the cross section.

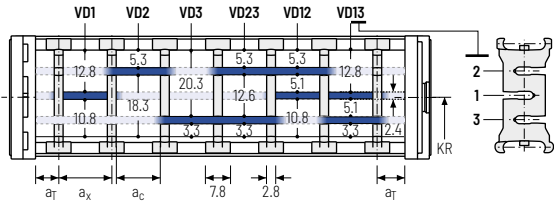

Order example

TS1

A

3

VD1

-

VD3

⋮

VD3

-

VD3

Divider system

Version

n_T

Height separation

Please state the designation of the divider system (**TS0, TS1...**), version and number of dividers per cross section [n_T].

If using divider systems with height separation (**TS1**) please also state the positions [e.g. VD1] viewed from the left driver belt. You are welcome to add a sketch to your order.

MT series

XLT series

ROBOTRAX® System

FLATVEVOR®

CLEANVEVOR®

LS/LSX series

S/SX series

S/SX-Tubes series

Accessories

TRAXLINE®

Aluminum cover RMD 02 – cover with hinge in the outer radius

- » Aluminum cover system with hinge for light and medium loads. Assembly without screws.
- » Available customized in **1 mm sections**.
- » **Outside:** swivable to both sides.
- » **Inside:** release by turning 90°.



Stay arrangement on each chain link (**VS: fully-stayed**)



1 mm B_i 33 – 180 mm
in 1 mm width sections

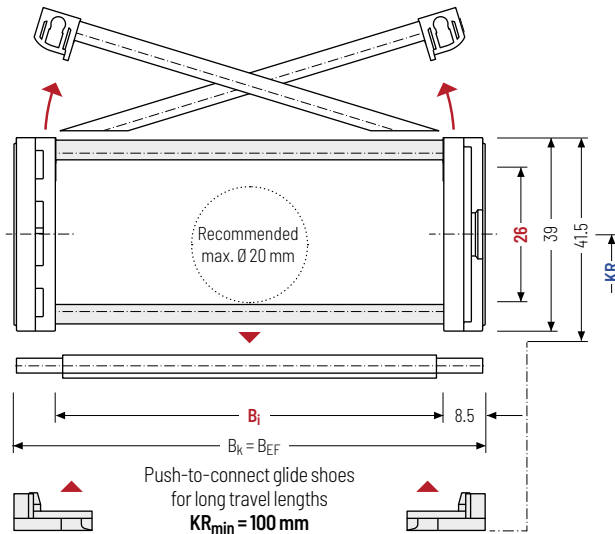

The maximum cable diameter strongly depends on the bending radius and the desired cable type. Please contact us.

Calculating the cable carrier length

Cable carrier length L_k

$$L_k \approx \frac{L_S}{2} + L_B$$

Cable carrier length L_k
rounded to pitch t

h_1 [mm]	h_G [mm]	h_G' [mm]	B_i [mm]*	B_k [mm]	B_{EF} [mm]	KR [mm]				q_k [kg/m]
26	39	41,5	33 – 180	$B_i + 17$	$B_i + 17$	75	100	130	160	1,40 – 4,92
						200	250	300		

* in 1 mm width sections

Order example



MT0475

Type

128

B_i [mm]

RMD 02

Stay variant

100

KR [mm]

1425

L_k [mm]

VS

Stay arrangement

Divider systems

As a standard, the divider system is mounted on every 2nd chain link.

As a standard, dividers or the complete divider system (dividers with height separations) are movable in the cross section (**version A**).

Divider system TSO without height separation

Vers.	a _T min [mm]	a _x min [mm]	a _c min [mm]	n _T min
A	6	7.8	5	-

The dividers can be moved in the cross section.

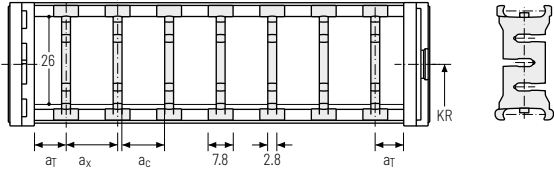

Divider system TS1 with continuous height separation

Vers.	a _T min [mm]	a _T max [mm]	a _x min [mm]	a _c min [mm]	n _T min
A	6	20	7.8	5	2

The dividers can be moved in the cross section.

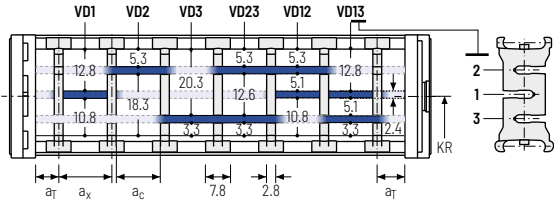

Order example

TS1

A

3

VD1

⋮

VD3

Divider system
Version
n_T
Height separation

Please state the designation of the divider system (**TS0, TS1...**), version and number of dividers per cross section [n_T].

If using divider systems with height separation (**TS1**) please also state the positions [e.g. VD1] viewed from the left driver belt. You are welcome to add a sketch to your order.

MT series

XLT series

ROBOTRAX® System

FLATVEVOR®

CLEANVEVOR®

LS/LSX series

S/SX series

S/SX-Tubes series

Accessories

TRAXLINE®

Plastic cover RDD 01 – cover with hinge in the inner radius

- » Plastic cover system with hinge for light and medium loads. Assembly without screws.
- » Available customized in **8 mm sections**.
- » **Outside:** release by rotating 90°.
- » **Inside:** swivable to both sides.



Stay arrangement on each chain link (**VS: fully-stayed**)



1mm B_i: 24 – 280 mm
in 8 mm width sections

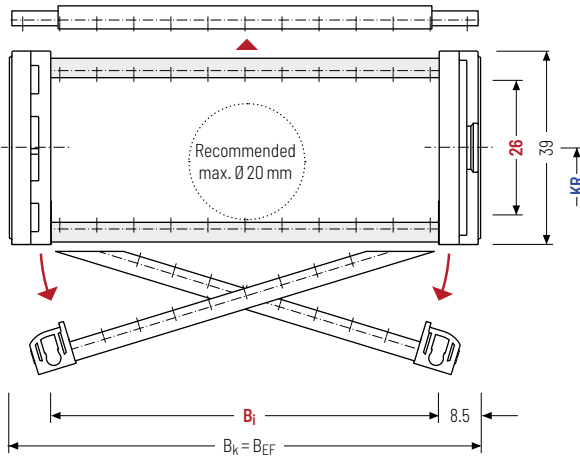

The maximum cable diameter strongly depends on the bending radius and the desired cable type. Please contact us.

Calculating the cable carrier length

Cable carrier length L_k

$$L_k \approx \frac{L_S}{2} + L_B$$

Cable carrier length L_k
rounded to pitch t

h_i [mm]	h_G [mm]	B_i [mm]									B_k [mm]	B_{EF} [mm]	KR [mm]		q_k [kg/m]	
26	39	24	32	40	48	56	64	72	80	88	$B_i + 17$	$B_i + 17$	75	100	0.90	
		96	104	112	120	128	136	144	152	160			130	160		-
		168	176	184	192	200	208	216	224	232			200	250		4.41
		240	248	256	264	272	280	300								

Order example



MT0475

Type

128

B_i [mm]

RDD 01

Stay variant

100

KR [mm]

1425

L_k [mm]

VS

Stay arrangement

Divider systems

As a standard, the divider system is assembled at every 2nd chain link.

For applications with lateral acceleration and laying on the side, the dividers or the complete divider system (dividers with height separations) are fixed in the cross section. The arresting cams click into place in the locking grids in the crossbars (**version B**).

Divider system TSO without height separation

Vers.	a _T min [mm]	a _x min [mm]	a _c min [mm]	a _x grid [mm]	n _T min
B	6	7.8	5	8	-

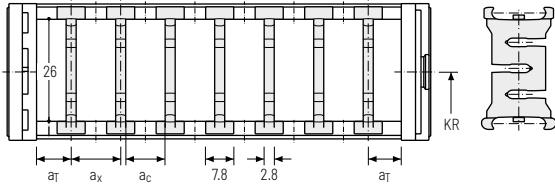

Divider system TS1 with continuous height separation

Vers.	a _T min [mm]	a _x min [mm]	a _c min [mm]	a _x grid [mm]	n _T min
B	6	7.8	5	8	2

The dividers are fixed in the cross section (version B).

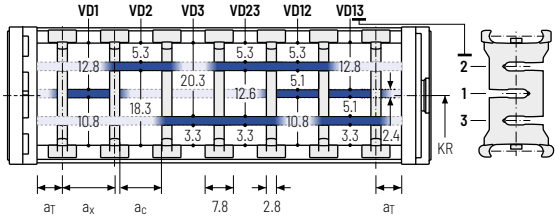

Divider system TS2 with partial height separation

Vers.	a _T min [mm]	a _x min [mm]	a _c min [mm]	a _x grid [mm]	n _T min
B	12	8*/24	5.2*/21.2	8	2

* for VRO

With grid distribution (8 mm grid). The dividers are fixed by the height separation, the grid is fixed in the cross section (version B).

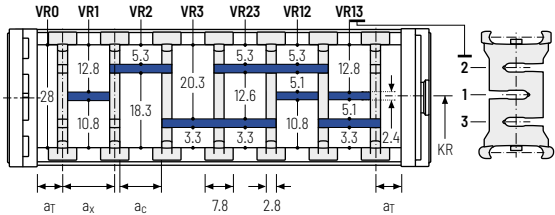

Order example

TS2

B

3

K1

34

VR1

⋮

⋮

K4

38

VR3

Divider system

Version

n_T

Chamber

a_x

Height separation

MT series

XLT series

ROBOTRAX® System

FLATVEVOR®

CLEANVEVOR®

LS/LSX series

S/SX series

S/SX-Tubes series

Accessories

TRAXLINE®

Plastic cover RDD 02 – cover with hinge in the outer radius

- » Plastic cover system with hinge for light and medium loads. Assembly without screws.
- » Available customized in **8 mm sections**.
- » **Outside:** swivable to both sides.
- » **Inside:** release by turning 90°.



Stay arrangement on each chain link (**VS: fully-stayed**)



1mm B_i: 24 – 280 mm
in 8 mm width sections

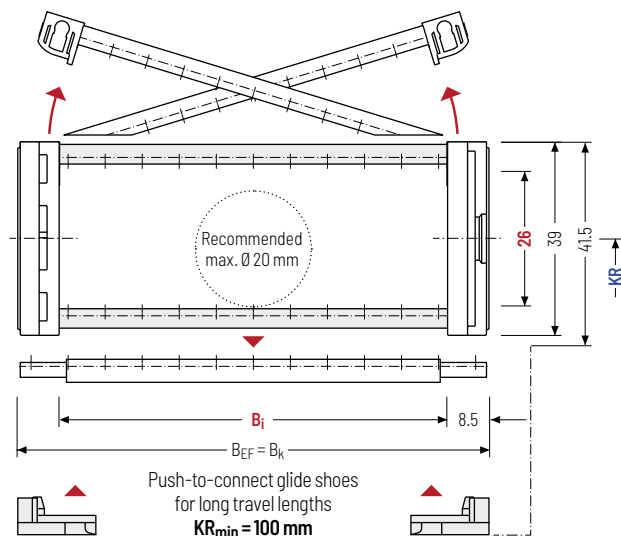

The maximum cable diameter strongly depends on the bending radius and the desired cable type. Please contact us.

Calculating the cable carrier length

Cable carrier length L_k

$$L_k \approx \frac{L_S}{2} + L_B$$

Cable carrier length L_k
rounded to pitch t

h_1 [mm]	h_G [mm]	B_i [mm]										B_k [mm]	B_{EF} [mm]	KR [mm]		q_k [kg/m]
26	39	24	32	40	48	56	64	72	80	88	$B_i + 17$	$B_i + 17$	75	100	0.90 - 4.41	
		96	104	112	120	128	136	144	152	160			130	160		
		168	176	184	192	200	208	216	224	232			200	250		
		240	248	256	264	272	280	300								

Order example



MT0475

Type

128

B_i [mm]

RDD 02

Stay variant

100

KR [mm]

1425

L_k [mm]

VS

Stay arrangement

Divider systems

As a standard, the divider system is assembled at every 2nd chain link.

For applications with lateral acceleration and laying on the side, the dividers or the complete divider system (dividers with height separations) are fixed in the cross section. The arresting cams click into place in the locking grids in the crossbars (**version B**).

Divider system TSO without height separation

Vers.	a _T min [mm]	a _x min [mm]	a _c min [mm]	a _x grid [mm]	n _T min
B	6	7.8	5	8	-

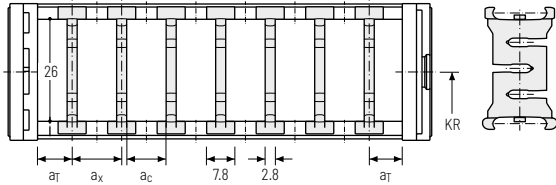

Divider system TS1 with continuous height separation

Vers.	a _T min [mm]	a _x min [mm]	a _c min [mm]	a _x grid [mm]	n _T min
B	6	7.8	5	8	2

The dividers are fixed in the cross section (version B).

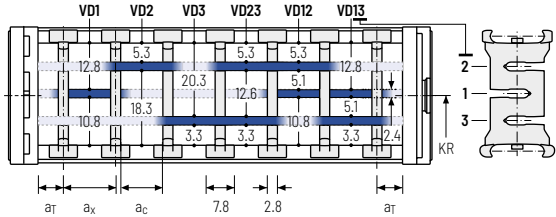

Divider system TS2 with partial height separation

Vers.	a _T min [mm]	a _x min [mm]	a _c min [mm]	a _x grid [mm]	n _T min
B	12	8*/24	5.2*/21.2	8	2

* for VRO

With grid distribution (8 mm grid). The dividers are fixed by the height separation, the grid is fixed in the cross section (version B).

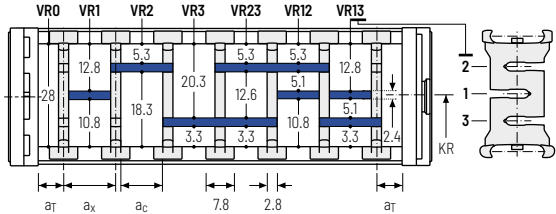

Order example

TS2

B

3

K1

34

VR1

⋮

⋮

K4

38

VR3

Divider system

Version

n_T

Chamber

a_x

Height separation

End connectors – plastic/steel (with strain relief)

Link end connector made of plastic, end connector made of sheet steel with screw-fixed aluminum strain relief. The connection variants on the fixed point and on the driver can be combined and, if required, changed afterwards.

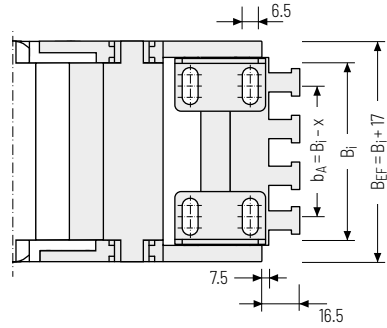
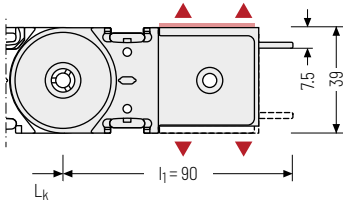

▲ Assembly options

B_i [mm]	x [mm]	n_z
40	17.5	3
56	21.5	4
80	17.5	6
104	19.0	8
128	19.5	9
152	17.5	11
192	18.5	14

Other widths only available without strain relief.

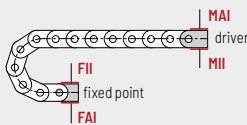

Connection point

F – fixed point
M – driver

Connection surface

I – connection surface inside

Connection type

A – threaded joint outside (standard)
I – threaded joint inside

Order example



Plastic/steel	F	A	I
Plastic/steel	M	A	I
End connector	Connection point	Connection type	Connection surface

End connectors - plastic/steel

Plastic link end connector, steel end connector. The connection variants on the fixed point and on the driver can be combined and, if required, changed afterwards.

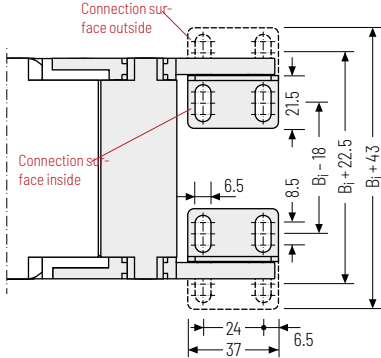
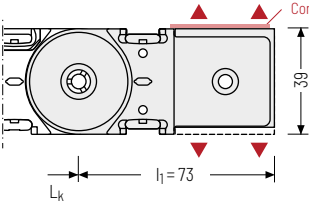

▲ Assembly options

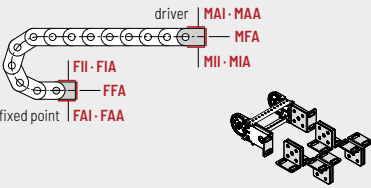

- Connection point**
F - fixed point
M - driver
- Connection surface**
A - connection surface outside
I - connection surface inside
- Connection type**
A - threaded joint outside (standard)
I - threaded joint inside
F - flange connection

Order example

	Plastic/steel	F	A	A
	Plastic/steel	M	U	
	End connector	Connection point	Connection type	Connection surface

We recommend the use of strain reliefs at the driver and fixed point. See from p. 904.

MT series	XLT series	ROBOTRAX® System	FLATVEYOR®	CLEANVEYOR®	LS/LSX series	S/SX series	S/SX-Tubes series	Accessories	TRAXLINE®
-----------	------------	------------------	------------	-------------	---------------	-------------	-------------------	-------------	-----------

MT0650



Pitch
65 mm



Inner height
38.5 mm



Inner widths
50 – 500 mm



Bending radii
95 – 350 mm

XLT
seriesROBOTRAX®
System

Stay variants



Aluminum cover RMD page 602

Cover with hinge in the outer radius "standard"

- » Aluminum cover system with hinge for light and medium loads. Assembly without screws.
- » **Outside:** swivable to both sides.
- » **Inside:** release by turning 90°.

FLATVEYOR®



Plastic cover RDD page 604

Cover with hinge in the outer radius "standard"

- » Plastic cover system with hinge for light and medium loads. Assembly without screws.
- » **Outside:** swivable to both sides.
- » **Inside:** release by turning by 90°.

CLEANVEYOR®

LS/LSX
seriesS/SX
seriesS/SX-Tubes
series

Accessories

TRAXLINE®



TOTALTRAX® complete systems

Benefit from the advantages of the TOTALTRAX® complete system. A complete delivery from one source – with a warranty certificate on request! Learn more at tsubaki-kabelschlepp.com/totaltrax



TRAXLINE® cables for cable carriers

Hi-flex electric cables which were especially developed, optimized and tested for use in cable carriers can be found at tsubaki-kabelschlepp.com/traxline

Unsupported arrangement

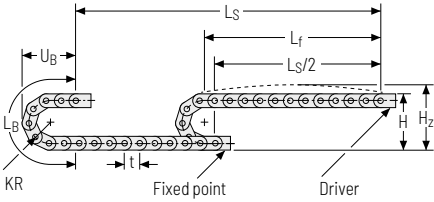

KR [mm]	H [mm]	H ₂ [mm]	L _B [mm]	U _B [mm]
95*	247	282	429	189
115	287	322	492	209
145	347	382	586	239
175	407	442	680	269
220	497	532	822	314
260	577	612	948	354
275	607	642	994	369
300	657	692	1073	394
350	757	792	1230	444

* not RMD

Load diagram for unsupported length

depending on the additional load.
Sagging of the cable carrier is technically permitted for extended travel lengths, depending on the specific application.
Intrinsic cable carrier weight $q_k = 3.5 \text{ kg/m}$. For other inner widths, the maximum additional load changes.

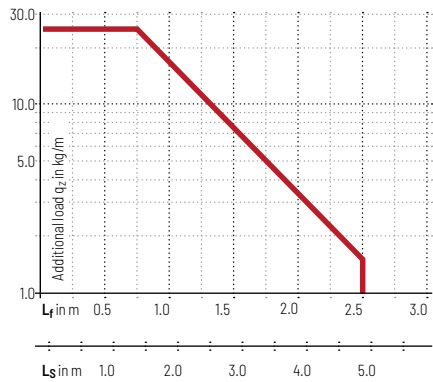

- Speed**
up to 10 m/s
- Acceleration**
up to 35 m/s²
- Travel length**
up to 4,8 m
- Additional load**
up to 25 kg/m

Gliding arrangement | GO module with chain links optimized for gliding

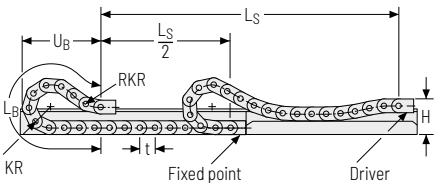

KR [mm]	H [mm]	GO module RKR [mm]	L _B [mm]	U _B [mm]
95*	171	300	1180	560
115	171	300	1310	605
145	171	300	1440	640
175	171	300	1635	705
220	171	300	1950	810
260	171	300	2275	926
275	171	300	2405	973
300	171	300	2535	1014
350	171	300	2925	1152

* not RMD

- Speed**
up to 8 m/s
- Acceleration**
up to 20 m/s²
- Travel length**
up to 170 m
- Additional load**
up to 25 kg/m

The gliding cable carrier must be guided in a channel. See p. 844.
The GO module mounted on the driver is a defined sequence of 5 adapted KR/RKR link plates.
Glide shoes have to be used for gliding applications.

Subject to change without notice.

MT series

XLT series

ROBOTRAX® System

FLATVEYOR®

CLEANVEYOR®

LS/LSX series

S/SX series

S/SX-Tubes series

Accessories

TRAXLINE®

Aluminum cover RMD – cover with hinge in the outer radius

- » Aluminum cover system with hinge for light and medium loads. Assembly without screws.
- » Available customized in **1 mm sections**.
- » **Outside:** swivable to both sides.
- » **Inside:** release by turning 90°.



Stay arrangement on each chain link (**VS: fully-stayed**)



1 mm B_i 100 – 500 mm
in 1 mm width sections

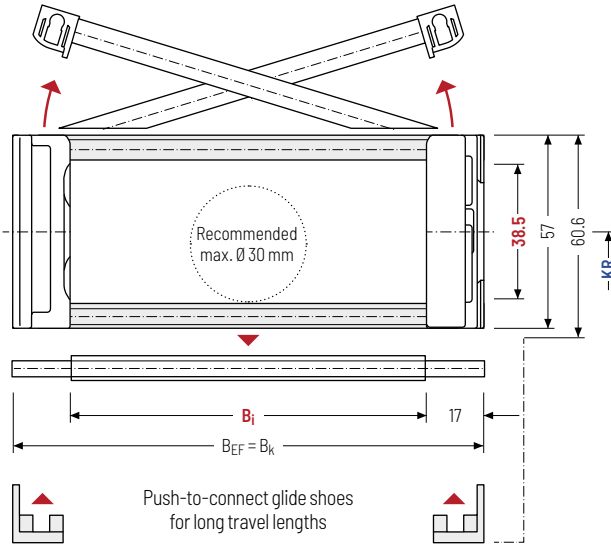

The maximum cable diameter strongly depends on the bending radius and the desired cable type. Please contact us.



For rough environmental conditions, we recommend the use of OFFROAD glide shoes with 80 % higher wear volume.

Calculating the cable carrier length

Cable carrier length L_k

$$L_k \approx \frac{L_S}{2} + L_B$$

Cable carrier length L_k
rounded to pitch t

h_i [mm]	h_G [mm]	h_G' [mm]	h_G' Offroad [mm]	B_i [mm]*	B_k [mm]	B_{EF} [mm]	KR [mm]				q_k [kg/m]
38.5	57	60.6	62.2	100 – 500	$B_i + 34$	$B_i + 34$	115	145	175	220	3.73 – 10.12
							260	275	300	350	

* in 1 mm width sections

Order example



MT0650

Type

300

B_i [mm]

RMD

Stay variant

175

KR [mm]

1430

L_k [mm]

VS

Stay arrangement

Divider systems

As a standard, the divider system is mounted on every 2nd chain link.

As a standard, dividers or the complete divider system (dividers with height separations) are movable in the cross section (**version A**).

Divider system TSO without height separation

Vers.	a _T min [mm]	a _x min [mm]	a _c min [mm]	n _T min
A	16	13	10	-

The dividers can be moved in the cross section.

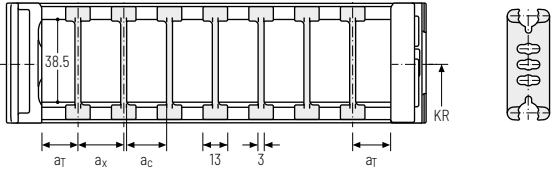

Divider system TS1 with continuous height separation

Vers.	a _T min [mm]	a _T max [mm]	a _x min [mm]	a _c min [mm]	n _T min
A	16	40	13	10	2

The dividers can be moved in the cross section.

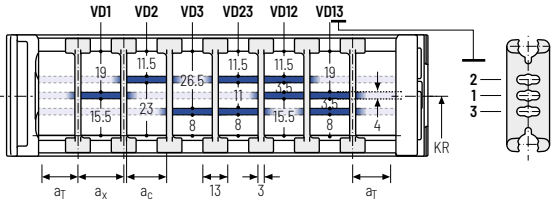

Order example

TS1

·

A

·

3

-

VD1

⋮

-

VD3

Divider system
Version
n_T
Height separation

Please state the designation of the divider system (**TS0, TS1...**), version and number of dividers per cross section [n_T].

If using divider systems with height separation (**TS1**) please also state the positions [e.g. VD1] viewed from the left driver belt. You are welcome to add a sketch to your order.

MT series

XLT series

ROBOTRAX® System

FLATVEVOR®

CLEANVEVOR®

LS/LSX series

S/SX series

S/SX-Tubes series

Accessories

TRAXLINE®

Plastic cover RDD – cover with hinge in the outer radius

- » Plastic cover system with hinge for light and medium loads. Assembly without screws.
- » Available customized in **8 mm sections**.
- » **Outside:** swivable to both sides.
- » **Inside:** release by turning 90°.



Stay arrangement on each chain link (**VS: fully-stayed**)



1mm B_i 50 – 258 mm
in 8 mm width sections

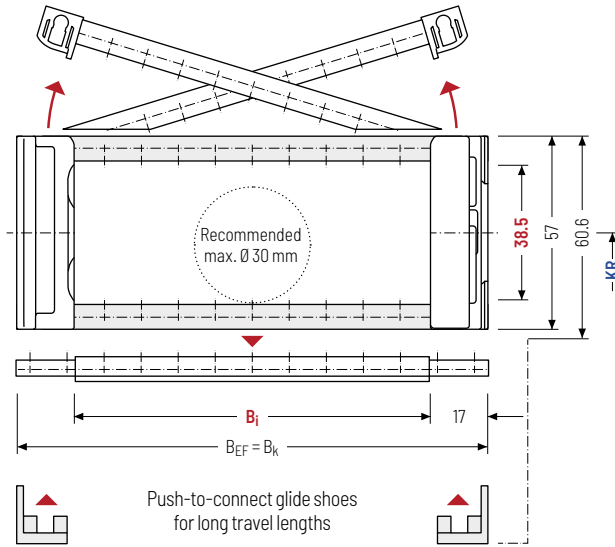

i The maximum cable diameter strongly depends on the bending radius and the desired cable type. Please contact us.

i For rough environmental conditions, we recommend the use of OFFROAD glide shoes with 80 % higher wear volume.

Calculating the cable carrier length

Cable carrier length L_k

$$L_k \approx \frac{L_S}{2} + L_B$$

Cable carrier length L_k
rounded to pitch t

h_i [mm]	h_g [mm]	h_g' [mm]	h_g' Offroad [mm]	B _i [mm]						B _k [mm]	B _{EF} [mm]	KR [mm]		q _k [kg/m]
38.5	57	60.6	62.2	50	58	66	74	82	90	B _i + 34	B _i + 34	95	115	2.40
				98	106	114	122	130	138			145	175	
				146	154	162	170	178	186			220	260	
				194	202	210	218	226	234			275	300	
				242	250	258						3.70		

Order example



MT0650

Type

300

B_i [mm]

RDD

Stay variant

175

KR [mm]

1430

L_k [mm]

VS

Stay arrangement

Divider systems

As a standard, the divider system is assembled at every 2nd chain link.

For applications with lateral acceleration and laying on the side, the dividers or the complete divider system (dividers with height separations) are fixed in the cross section. The arresting cams click into place in the locking grids in the crossbars (**version B**).

Divider system TSO without height separation

Vers.	a _T min [mm]	a _x min [mm]	a _c min [mm]	a _x grid [mm]	n _T min
B	13	16	11,8	8	-

The dividers are fixed in the cross section (version B).

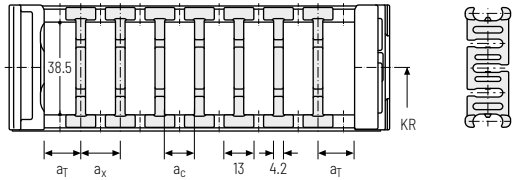

Divider system TS1 with continuous height separation

Vers.	a _T min [mm]	a _T max [mm]	a _x min [mm]	a _c min [mm]	a _x grid [mm]	n _T min
B	13	21	16	11,8	8	2

The dividers are fixed in the cross section (version B).

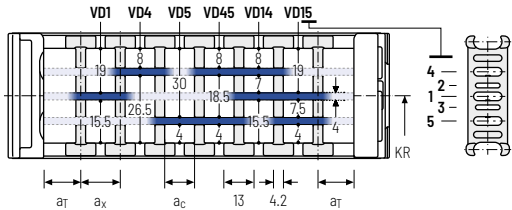

Order example

TS1

A

3

VD1

-

⋮

VD3

-

Divider system

Version

n_T

Height separation

Please state the designation of the divider system (**TS0, TS1,...**), the version, and the number of dividers per cross section [n_T].

When using divider systems with height separation (**TS1**), please additionally state the position (e.g. VD1) viewed from the left driver belt. You are welcome to add a sketch to your order.

MT series
XLT series
ROBOTRAX® System
FLATVEVOR®
CLEANVEVOR®
LS/LSX series
S/SX series
S/SX-Tubes series
Accessories
TRAXLINE®

Universal end connectors UMB - plastic (standard)

The universal end connectors (UMB) are made from plastic and can be mounted **from the top, from the bottom, face on or from the side.**

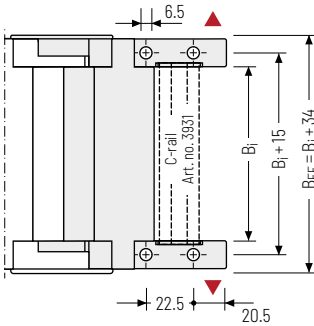
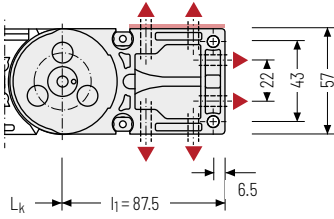

 Recommended tightening torque: 11 Nm for cheese-head screws ISO 4762 - M6 - 8.8

Connection point

- F** - fixed point
- M** - driver

Connection type

- U** - universal end connector

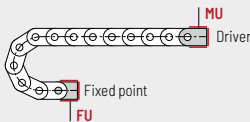

End connectors - plastic/steel

Plastic link end connector, steel end connector. The connection variants on the fixed point and on the driver can be combined and, if required, changed afterwards.

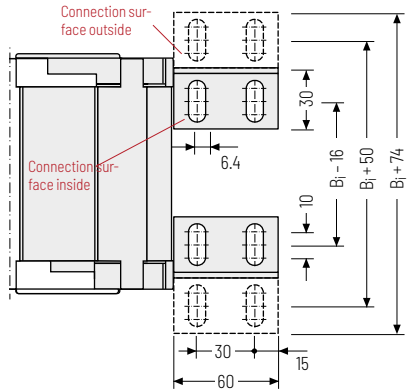
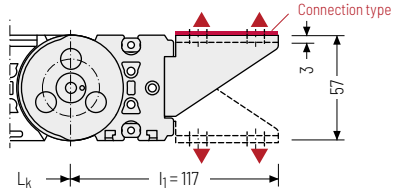

 Assembly options

Connection point

- F** - fixed point
- M** - driver

Connection surface

- A** - connection surface outside
- I** - connection surface inside

Connection type

- A** - threaded joint outside (standard)
- I** - threaded joint inside
- F** - flange connection

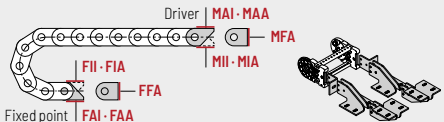

Order example

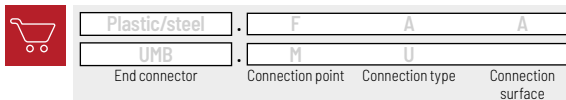

 We recommend the use of strain reliefs at the driver and fixed point. See from p. 904.

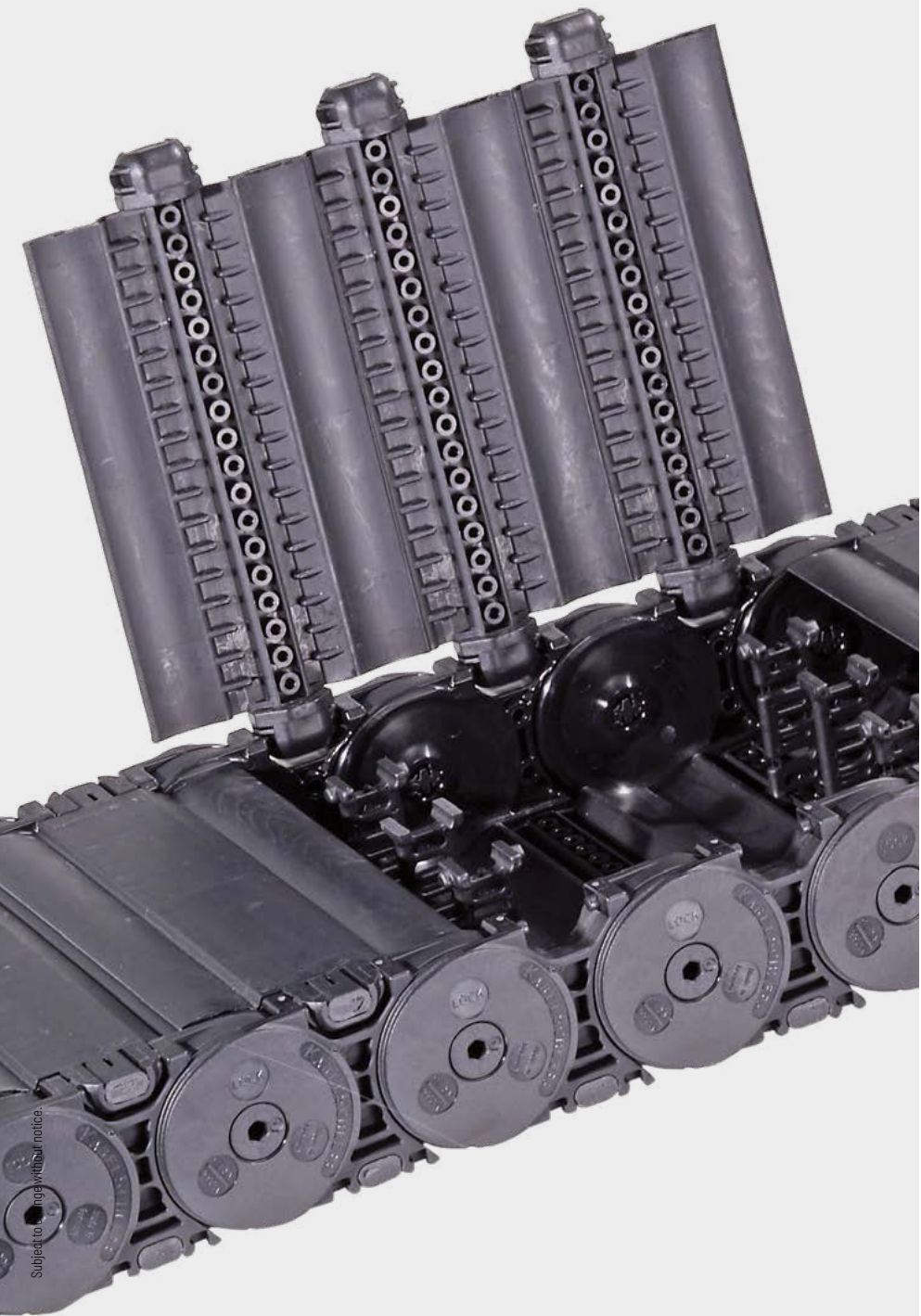

Subject to change without notice.

MT
series

XLT
series

ROBOTRAX®
System

FLATVEYOR®

CLEANVEYOR®

LS/LSX
series

S/SX
series

S/SX-Tubes
series

Accessories

TRAXLINE®

MT0950



Pitch
95 mm



Inner heights
54.5 mm



Inner widths
77 - 600 mm



Bending radii
140 - 380 mm

XLT
seriesROBOTRAX®
System

FLATVEYOR®

CLEANVEYOR®

LS/LSX
seriesS/SX
seriesS/SX-Tubes
series

Accessories

TRAXLINE®

Stay variants



Aluminum cover RMD page 610

Cover with hinge in the outer radius "standard"

- » Aluminum cover system with hinge for light and medium loads. Assembly without screws.
- » **Outside:** swivable to both sides.
- » **Inside:** release by turning 90°.



Plastic cover RDD page 612

Cover with hinge in the outer radius "standard"

- » Plastic cover system with hinge for light and medium loads. Assembly without screws.
- » **Outside:** swivable to both sides.
- » **Inside:** release by turning by 90°.



TOTALTRAX® complete systems

Benefit from the advantages of the TOTALTRAX® complete system. A complete delivery from one source – with a warranty certificate on request! Learn more at tsubaki-kabelschlepp.com/totaltrax



TRAXLINE® cables for cable carriers

Hi-flex electric cables which were especially developed, optimized and tested for use in cable carriers can be found at tsubaki-kabelschlepp.com/traxline

Unsupported arrangement

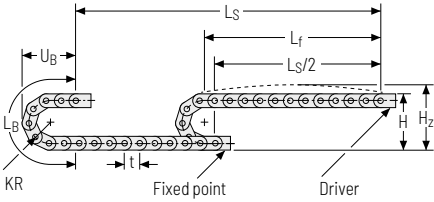

KR [mm]	H [mm]	H _z [mm]	L _B [mm]	U _B [mm]
140*	360	405	630	275
170*	420	465	725	305
200	480	525	819	335
260	600	645	1007	395
290	660	705	1102	425
320	720	765	1196	445
380	840	885	1384	515

* not RMD





Load diagram for unsupported length

depending on the additional load.

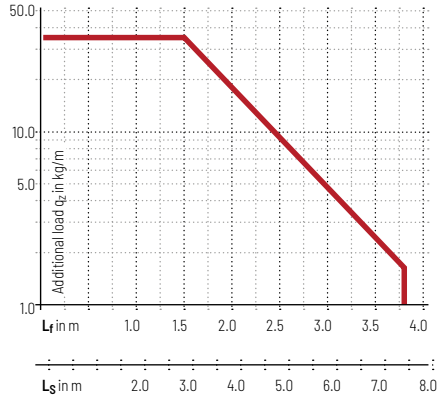
Sagging of the cable carrier is technically permitted for extended travel lengths, depending on the specific application.

Intrinsic cable carrier weight $q_k = 7 \text{ kg/m}$. For other inner widths, the maximum additional load changes.





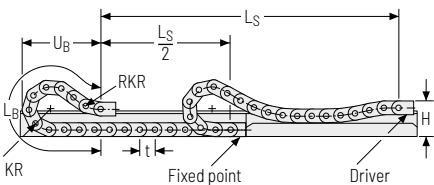

-  **Speed**
up to 10 m/s
-  **Acceleration**
up to 25 m/s²
-  **Travel length**
up to 7,4 m
-  **Additional load**
up to 35 kg/m

Gliding arrangement | GO module with chain links optimized for gliding



KR [mm]	H [mm]	GO module RKR [mm]	L _B [mm]	U _B [mm]
140*	240	500	1580	740
170*	240	500	1710	773
200	240	500	1995	888
260	240	500	2565	1114
290	240	500	2755	1183
320	240	500	3040	1296
380	240	500	3610	1523

* not RMD

-  **Speed**
up to 8 m/s
-  **Acceleration**
up to 20 m/s²
-  **Travel length**
up to 230 m
-  **Additional load**
up to 35 kg/m

 The gliding cable carrier must be guided in a channel. See p. 844.

The GO module mounted on the driver is a defined sequence of 4 adapted KR/RKR link plates.

Glide shoes have to be used for gliding applications.

Aluminum cover RMD – cover with hinge in the outer radius

- » Aluminum cover system with hinge for light and medium loads. Assembly without screws.
- » Available customized in **1 mm sections**.
- » **Outside:** swivable to both sides.
- » **Inside:** release by turning 90°.



Stay arrangement on each chain link (**VS: fully-stayed**)



1 mm B_i 100 – 600 mm
in 1 mm width sections

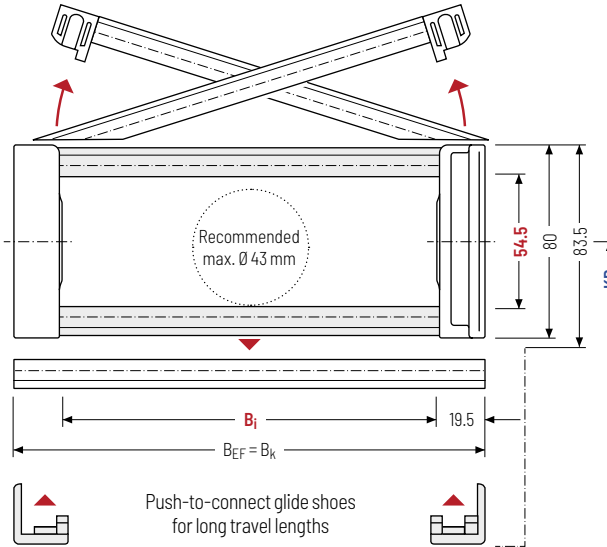

The maximum cable diameter strongly depends on the bending radius and the desired cable type. Please contact us.



For rough environmental conditions, we recommend the use of OFFROAD glide shoes with 80 % higher wear volume.

Calculating the cable carrier length

Cable carrier length L_k

$$L_k \approx \frac{L_S}{2} + L_B$$

Cable carrier length L_k
rounded to pitch t

h_i [mm]	h_g [mm]	h_g' [mm]	h_g' Offroad [mm]	B_i [mm]*	B_k [mm]	B_{EF} [mm]	KR [mm]				q_k [kg/m]	
54.5	80	83.5	86	100 – 600	$B_i + 39$	$B_i + 39$	200	260	290	320	380	6.12 – 17.13

* in 1 mm width sections

Order example



MT0950

Type

400

B_i [mm]

RMD

Stay variant

200

KR [mm]

2850

L_k [mm]

VS

Stay arrangement

Divider systems

As a standard, the divider system is mounted on every 2nd chain link.

As a standard, dividers or the complete divider system (dividers with height separations) are movable in the cross section (**version A**).

Divider system TSO without height separation

Vers.	a _T min [mm]	a _x min [mm]	a _c min [mm]	n _T min
A	3.5	12	8	-

The dividers can be moved in the cross section.

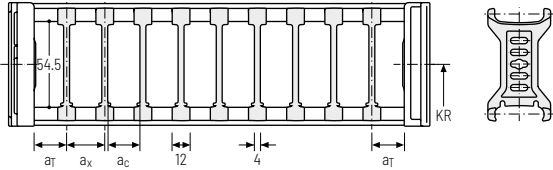

Divider system TS1 with continuous height separation

Vers.	a _T min [mm]	a _T max [mm]	a _x min [mm]	a _c min [mm]	n _T min
A	3.5	25	12	8	2

The dividers can be moved in the cross section.

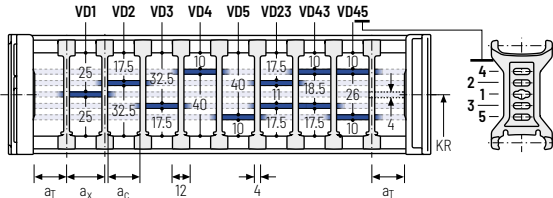

Divider system TS2 with partial height separation

Vers.	a _T min [mm]	a _x min [mm]	a _c min [mm]	n _T min
A	4.5	21	15	2

With grid distribution (1 mm grid). The dividers are attached by the height separation, the grid can be moved in the cross section.

Sliding dividers are optionally available (thickness of divider = 4 mm).

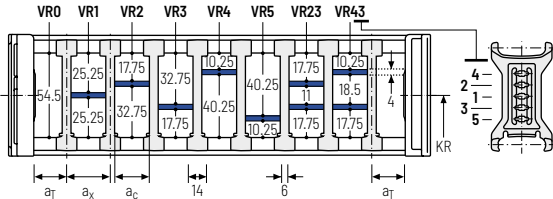

Order example

TS2 · A · 3 · K1 · 34 - VR1

⋮

⋮

⋮

· K4 · 38 - VR3

Divider system
Version
n_T
Chamber
a_x
Height separation

Please state the designation of the divider system (**TS0, TS1...**), version and number of dividers per cross section [n_T]. In addition, please also enter the chambers [K] from left to right, as well as the assembly distances [a_r/a_s] (as seen from the driver).

If using divider systems with height separation (**TS1 – TS2**) please also state the positions [e.g. VD23] viewed from the left driver belt. You are welcome to add a sketch to your order.

MT series

XLT series

ROBOTRAX® System

FLATVEVOR®

CLEANVEVOR®

LS/LSX series

S/SX series

S/SX-Tubes series

Accessories

TRAXLINE®

Plastic cover RDD – cover with hinge in the outer radius

- » Plastic cover system with hinge for light and medium loads. Assembly without screws.
- » Available customized in **16 mm sections**.
- » **Outside:** swivable to both sides.
- » **Inside:** release by turning 90°.

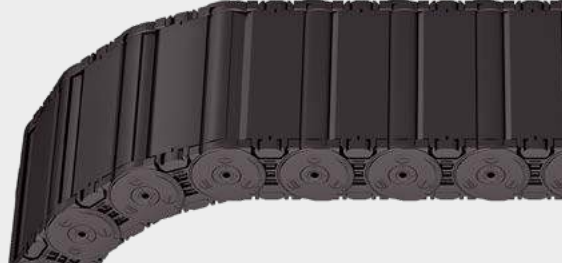

Stay arrangement on each chain link (**VS: fully-stayed**)



1mm B_i 77 – 349 mm
in **16 mm** width sections

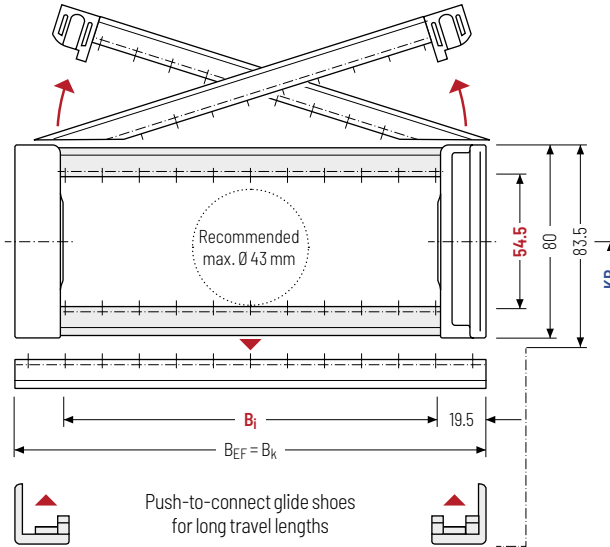

The maximum cable diameter strongly depends on the bending radius and the desired cable type. Please contact us.



For rough environmental conditions, we recommend the use of OFFROAD glide shoes with 80 % higher wear volume.

Calculating the cable carrier length

Cable carrier length L_k

$$L_k \approx \frac{L_S}{2} + L_B$$

Cable carrier length L_k
rounded to pitch t

h_i [mm]	h_G [mm]	h_G' [mm]	h_G' Offroad [mm]	B_i [mm]						B_k [mm]	B_{EF} [mm]	KR [mm]			q_k [kg/m]
54.5	80	83.5	86	77	93	109	125	141	157	$B_i + 39$	$B_i + 39$	140	170	200	4.3
				173	189	205	221	237	253			260	290	320	
				269	285	301	317	333	349			380	-	7.7	

Order example



MT0950

Type

269

B_i [mm]

RDD

Stay variant

200

KR [mm]

2850

L_k [mm]

VS

Stay arrangement

Divider systems

As a standard, the divider system is assembled at every 2nd chain link.

For applications with lateral acceleration and laying on the side, the dividers or the complete divider system (dividers with height separations) are fixed in the cross section. The arresting cams click into place in the locking grids in the crossbars (**version B**).

Divider system TS0 without height separation

Vers.	a _T min [mm]	a _x min [mm]	a _c min [mm]	a _x grid [mm]	η _T min
B	22,5	16	10	16	-

The dividers are fixed in the cross section (version B).

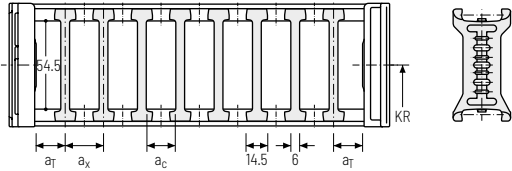

Divider system TS1 with continuous height separation

Vers.	a _T min [mm]	a _T max [mm]	a _x min [mm]	a _c min [mm]	a _x grid [mm]	η _T min
B	22,5	22,5	16	10	16	2

The dividers are fixed in the cross section (version B).

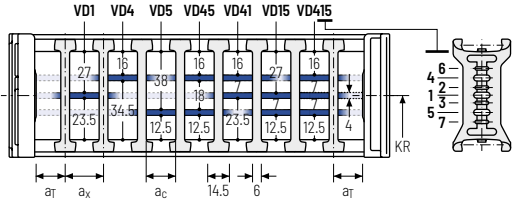

Divider system TS2 with partial height separation

Vers.	a _T min [mm]	a _x min [mm]	a _c min [mm]	a _x grid [mm]	η _T min
B	22,5	16*/32	10*/26	16	2

* for VR0

With grid distribution (16 mm grid). The dividers are fixed by the height separation, the grid is fixed in the cross section (version B).

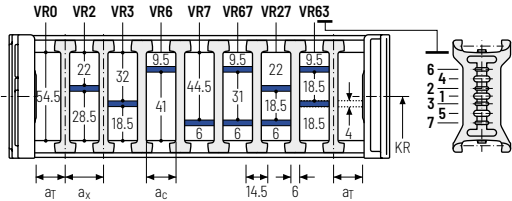

MT series
XLT series
ROBOTRAX® System
FLATVEVOR®
CLEANVEVOR®
LS/LSX series
S/SX series
S/SX-Tubes series
Accessories
TRAXLINE®

More product information online



Assembly instructions etc.: Additional info via your smartphone or check online at tsubaki-kabelschlepp.com/downloads



Configure your custom cable carrier here: online-engineer.de

Divider system TS3 with height separation made of plastic partitions

Vers.	a_T min [mm]	a_x min [mm]	a_c min [mm]	n_T min
B	6,5	16 / 42*	8	2

* For aluminum partitions

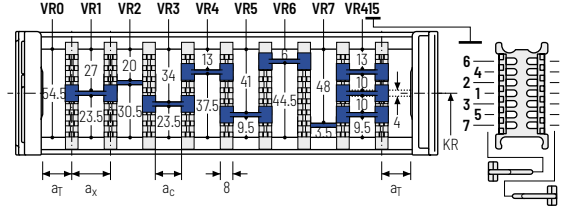

The dividers are fixed by the partitions, the complete divider system is movable in the cross section.

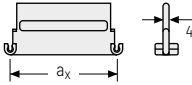

Aluminum partitions in 1 mm width sections with $a_x > 42$ mm are also available.

a_x (center distance of dividers) [mm]												
a_c (nominal width of inner chamber) [mm]												
16	32	48	64	80	96	112	128	144	160	176	192	208
8	24	40	56	72	88	104	120	136	152	168	184	200

When using **plastic partitions with $a_x > 112$ mm**, we recommend an additional center support with a **twin divider** ($S_T = 4$ mm). Twin dividers are also suitable for retrofitting in the partition system.

Order example



TS3	B	3	K1	34	VR1
			⋮	⋮	⋮
			K4	38	VR3
Divider system	Version	n_T	Chamber	a_x	Height separation

Please state the designation of the divider system (**TS0, TS1...**), version and number of dividers per cross section [n_T]. In addition, please also enter the chambers [K] from left to right, as well as the assembly distances [a_T/a_x] (as seen from the driver).

If using divider systems with height separation (**TS1, TS3**) please also state the positions [e.g. VD23] viewed from the left driver belt. You are welcome to add a sketch to your order.

More product information online



Assembly instructions etc.:
Additional info via your smartphone or check online at [tsubaki-kabelschlepp.com/downloads](https://www.tsubaki-kabelschlepp.com/downloads)



Configure your custom cable carrier here:
[online-engineer.de](https://www.online-engineer.de)

Universal end connectors UMB - plastic (standard)

The universal end connectors (UMB) are made from plastic and can be mounted **from the top, from the bottom, face on or from the side.**

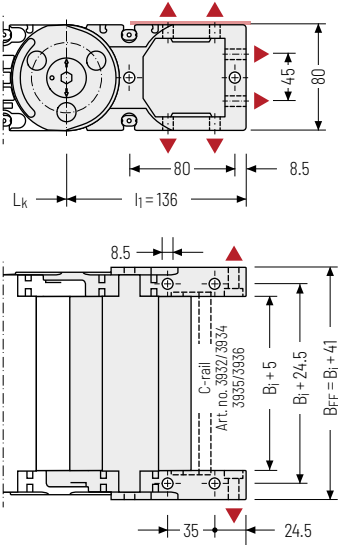

 Recommended tightening torque: 27 Nm for cheese-head screws ISO 4762 - M8 - 8.8

Connection point

F - fixed point
M - driver

Connection type

U - universal end connector

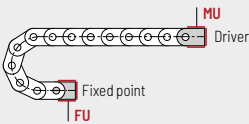

Order example

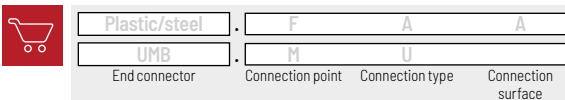

End connectors - plastic/steel

Plastic link end connector, steel end connector. The connection variants on the fixed point and on the driver can be combined and, if required, changed afterwards.

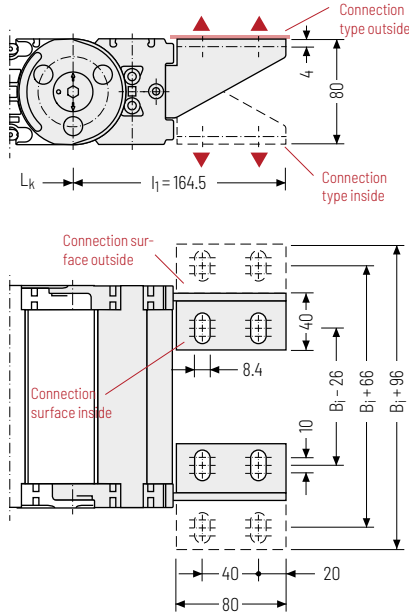

 Assembly options

Connection point

F - fixed point
M - driver

Connection surface

A - connection surface outside
I - connection surface inside

Connection type

A - threaded joint outside (standard)
I - threaded joint inside
F - flange connection

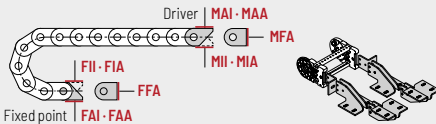

 We recommend the use of strain reliefs at the driver and fixed point. See from p. 904.

MT1250



Pitch
125 mm



Inner height
68.5 mm



Inner widths
103 – 800 mm



Bending radii
220 – 500 mm

Stay variants



Aluminum cover RMD page 618

Cover with hinge in the outer radius "standard"

- » Aluminum cover system with hinge for light and medium loads. Assembly without screws.
- » **Outside:** swivable to both sides.
- » **Inside:** release by turning 90°.



Plastic cover RDD page 620

Cover with hinge in the outer radius "standard"

- » Plastic cover system with hinge for light and medium loads. Assembly without screws.
- » **Outside:** swivable to both sides.
- » **Inside:** release by turning by 90°.



TOTALTRAX® complete systems

Benefit from the advantages of the TOTALTRAX® complete system. A complete delivery from one source – with a warranty certificate on request! Learn more at tsubaki-kabelschlepp.com/totaltrax



TRAXLINE® cables for cable carriers

Hi-flex electric cables which were especially developed, optimized and tested for use in cable carriers can be found at tsubaki-kabelschlepp.com/traxline

Unsupported arrangement

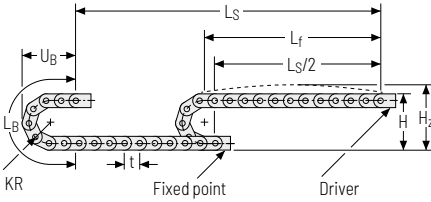

KR [mm]	H [mm]	H ₂ [mm]	L _B [mm]	U _B [mm]
220*	536	586	942	393
260	616	666	1067	433
300	696	746	1193	473
340	776	826	1319	513
380	856	906	1444	553
500	1096	1146	1821	673

* not RMD



Load diagram for unsupported length

depending on the additional load.

Sagging of the cable carrier is technically permitted for extended travel lengths, depending on the specific application.

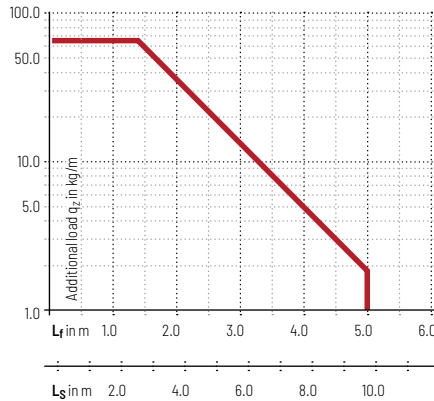
Intrinsic cable carrier weight $q_k = 8.0 \text{ kg/m}$. For other inner widths, the maximum additional load changes.





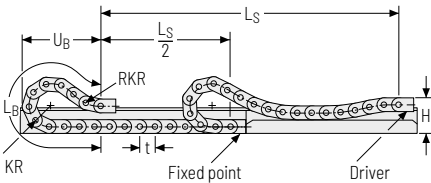

-  **Speed**
up to 10 m/s
-  **Acceleration**
up to 20 m/s²
-  **Travel length**
up to 9.7 m
-  **Additional load**
up to 65 kg/m

Gliding arrangement | GO module with chain links optimized for gliding



KR [mm]	H [mm]	GO module RKR [mm]	L _B [mm]	U _B [mm]
220*	288	500	2250	1015
260	288	500	2500	1095
300	288	500	2750	1177
340	288	500	3125	1318
380	288	500	3375	1403
500	288	500	4375	1770

* not RMD

-  **Speed**
up to 8 m/s
-  **Acceleration**
up to 20 m/s²
-  **Travel length**
up to 270 m
-  **Additional load**
up to 65 kg/m

 The gliding cable carrier must be guided in a channel. See p. 844.

The GO module mounted on the driver is a defined sequence of 4 adapted KR/RKR link plates.

Glide shoes have to be used for gliding applications.

MT series
XLT series
ROBOTRAX® System
FLATVEVOR®
CLEANVEVOR®
LS/LSX series
S/SX series
S/SX-Tubes series
Accessories
TRAXLINE®

Aluminum cover RMD – cover with hinge in the outer radius

- » Aluminum cover system with hinge for light and medium loads. Assembly without screws.
- » Available customized in **1 mm sections**.
- » **Outside:** swivable to both sides.
- » **Inside:** release by turning 90°.



Stay arrangement on each chain link (**VS: fully-stayed**)



1 mm B_i 150 – 800 mm
in 1 mm width sections

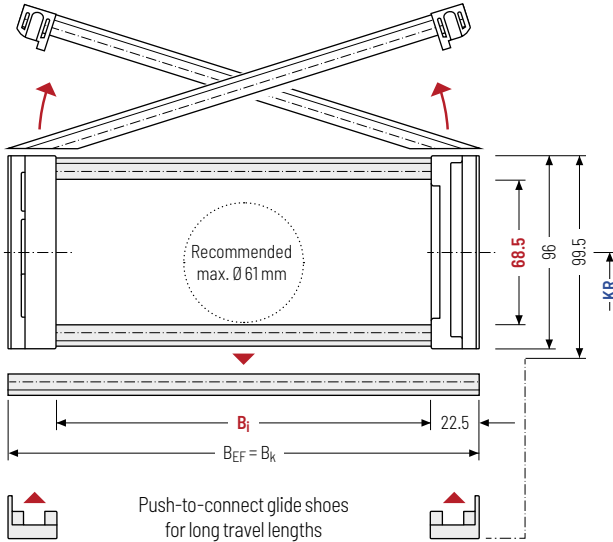

The maximum cable diameter strongly depends on the bending radius and the desired cable type. Please contact us.



For rough environmental conditions, we recommend the use of OFFROAD glide shoes with 80 % higher wear volume.

Calculating the cable carrier length

Cable carrier length L_k

$$L_k \approx \frac{L_S}{2} + L_B$$

Cable carrier length L_k
rounded to pitch t

h_i [mm]	h_G [mm]	h_G' [mm]	h_G' Offroad [mm]	B_i [mm]*	B_k [mm]	B_{EF} [mm]	KR [mm]			q_k [kg/m]		
68.5	96	99.5	103	150 – 800	$B_i + 45$	$B_i + 45$	260	300	340	380	500	9.29 – 26.34

* in 1 mm width sections

Order example



MT1250

Type

600

B_i [mm]

RMD

Stay variant

300

KR [mm]

4250

L_k [mm]

VS

Stay arrangement

Divider systems

As a standard, the divider system is mounted on every 2nd chain link.

As a standard, dividers or the complete divider system (dividers with height separations) are movable in the cross section (**version A**).

Divider system TS0 without height separation

Vers.	a _T min [mm]	a _x min [mm]	a _c min [mm]	n _T min
A	6	12	8	-

The dividers can be moved in the cross section.

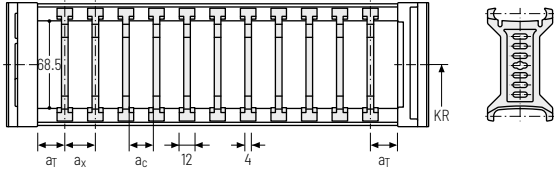

Divider system TS1 with continuous height separation

Vers.	a _T min [mm]	a _T max [mm]	a _x min [mm]	a _c min [mm]	n _T min
A	6	25	12	8	2

The dividers can be moved in the cross section.

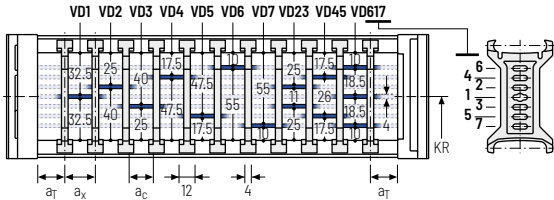

Divider system TS2 with partial height separation

Vers.	a _T min [mm]	a _x min [mm]	a _c min [mm]	n _T min
A	7	21	15	2

With grid distribution (1mm grid). The dividers are attached by the height separation, the grid can be moved in the cross section.

Sliding dividers are optionally available (thickness of divider = 4 mm).

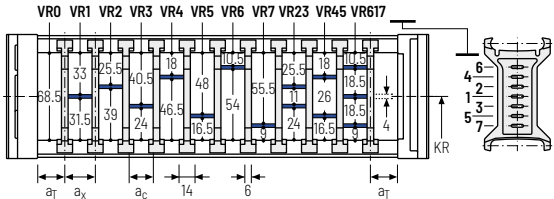

Order example

TS2

A

3

K1

34

VR1

⋮
 ⋮
 ⋮

K4

38

VR3

Divider system Version n_T Chamber a_x Height separation

Please state the designation of the divider system (**TS0, TS1...**), version and number of dividers per cross section [n_T]. In addition, please also enter the chambers [K] from left to right, as well as the assembly distances [a_T/a_x] (as seen from the driver).

If using divider systems with height separation (**TS1 – TS2**) please also state the positions [e.g. VD23] viewed from the left driver belt. You are welcome to add a sketch to your order.

MT series

XLT series

ROBOTRAX® System

FLATVEVOR®

CLEANVEVOR®

LS/LSX series

S/SX series

S/SX-Tubes series

Accessories

TRAXLINE®

Plastic cover RDD – cover with hinge in the outer radius

- » Plastic cover system with hinge for light and medium loads. Assembly without screws.
- » Available customized in **16 mm sections**.
- » **Outside:** swivable to both sides.
- » **Inside:** release by turning 90°.

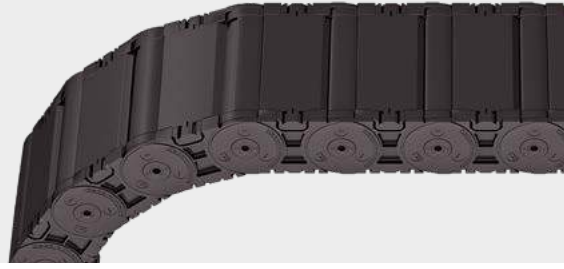

Stay arrangement on each chain link (**VS: fully-stayed**)



1mm B_i 103 – 359 mm
in 16 mm width sections

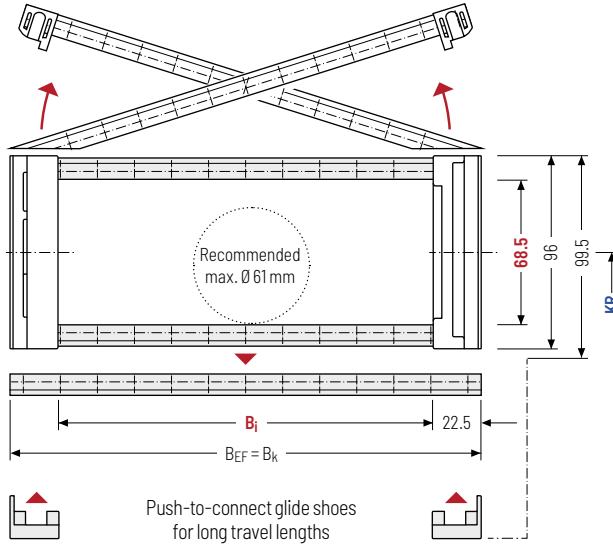

The maximum cable diameter strongly depends on the bending radius and the desired cable type. Please contact us.



For rough environmental conditions, we recommend the use of OFFROAD glide shoes with 80 % higher wear volume.

Calculating the cable carrier length

Cable carrier length L_k

$$L_k \approx \frac{L_S}{2} + L_B$$

Cable carrier length L_k
rounded to pitch t

h_i [mm]	h_g [mm]	h_g' [mm]	h_g' Offroad [mm]	B_i [mm]					B_k [mm]	B_{EF} [mm]	KR [mm]		q_k [kg/m]	
68.5	96	99.5	103	103	119	135	151	167	183	$B_i + 45$	$B_i + 45$	220	260	5.7
				199	215	231	247	263	279			300	340	-
				295	311	327	343	359	380			500	8.9	

Order example



MT1250

Type

295

B_i [mm]

RDD

Stay variant

300

KR [mm]

4250

L_k [mm]

VS

Stay arrangement

Divider systems

As a standard, the divider system is assembled at every 2nd chain link.

For applications with lateral acceleration and laying on the side, the dividers or the complete divider system (dividers with height separations) are fixed in the cross section. The arresting cams click into place in the locking grids in the crossbars (**version B**).

Divider system TSO without height separation

Vers.	a _T min [mm]	a _x min [mm]	a _c min [mm]	a _x grid [mm]	η _T min
B	19,5	16	8	16	-

The dividers are fixed in the cross section (version B).

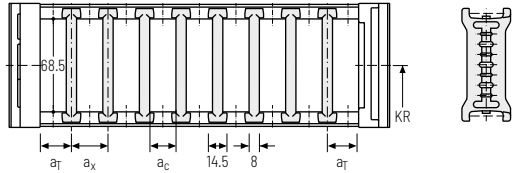

Divider system TS1 with continuous height separation

Vers.	a _T min [mm]	a _T max [mm]	a _x min [mm]	a _c min [mm]	a _x grid [mm]	η _T min
B	19,5	19,5	16	8	16	2

The dividers are fixed in the cross section (version B).

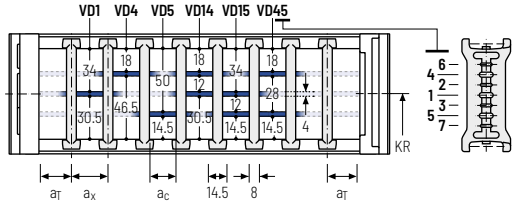

Divider system TS2 with partial height separation

Vers.	a _T min [mm]	a _x min [mm]	a _c min [mm]	a _x grid [mm]	η _T min
B	19,5	16*/32	8*/24	16	2

* for VR0

With grid distribution (16 mm grid). The dividers are fixed by the height separation, the grid is fixed in the cross section (version B).

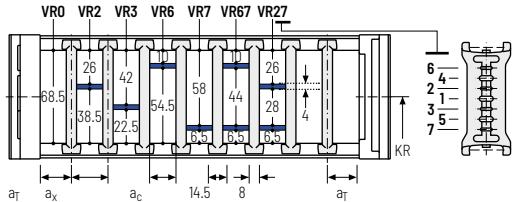

More product information online



Assembly instructions etc.: Additional info via your smartphone or check online at tsubaki-kabelschlepp.com/downloads



Configure your custom cable carrier here: online-engineer.de

MT series
XLT series
ROBOTRAX® System
FLATVEVOR®
CLEANVEVOR®
LS/LSX series
S/SX series
S/SX-Tubes series
Accessories
TRAXLINE®

Divider system TS3 with height separation made of plastic partitions

Vers.	a_T min [mm]	a_x min [mm]	a_c min [mm]	n_T min
B	4 / 16*	16 / 42**	8	2

* For VRO

** For aluminum partitions.

The dividers are fixed by the partitions, the complete divider system is fixed in the cross section.

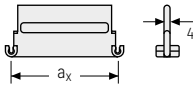
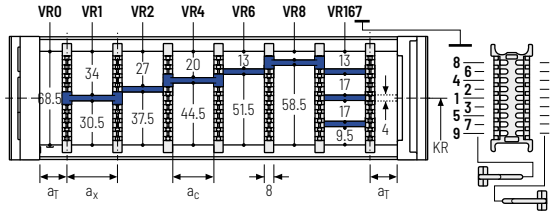

Aluminum partitions in 1 mm width sections with $a_x > 42$ mm are also available.

a_x (center distance of dividers) [mm]												
a_c (nominal width of inner chamber) [mm]												
16	32	48	64	80	96	112	128	144	160	176	192	208
8	24	40	56	72	88	104	120	136	152	168	184	200

When using **plastic partitions with $a_x > 112$ mm**, we recommend an additional center support with a **twin divider** ($S_T = 4$ mm). Twin dividers are also suitable for retrofitting in the partition system. The height separations VR8 and VR9 are not possible when using twin dividers.

Order example



TS3	B	3	K1	34	VR1
			⋮	⋮	⋮
			K4	38	VR3
Divider system	Version	n_T	Chamber	a_x	Height separation

Please state the designation of the divider system (**TS0, TS1...**), version and number of dividers per cross section [n_T]. In addition, please also enter the chambers [K] from left to right, as well as the assembly distances [a_T/a_x] (as seen from the driver).

If using divider systems with height separation (**TS1, TS3**) please also state the positions [e.g. VD23] viewed from the left driver belt. You are welcome to add a sketch to your order.

More product information online



Assembly instructions etc.:
Additional info via your
smartphone or check online at
[tsubaki-kabelschlepp.com/
downloads](https://tsubaki-kabelschlepp.com/downloads)



Configure your custom
cable carrier here:
online-engineer.de

Universal end connectors UMB – plastic (standard)

The universal end connectors (UMB) are made from plastic and can be mounted **from the top, from the bottom, face on or from the side**.

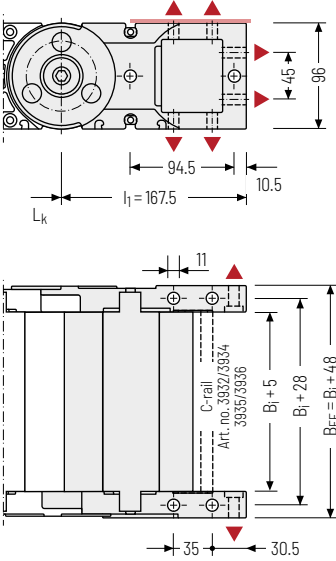

 Recommended tightening torque: 54 Nm for cheese-head screws ISO 4762 - M10 - 8.8

End connectors – plastic/steel

Plastic link end connector, steel end connector. The connection variants on the fixed point and on the driver can be combined and, if required, changed afterwards.

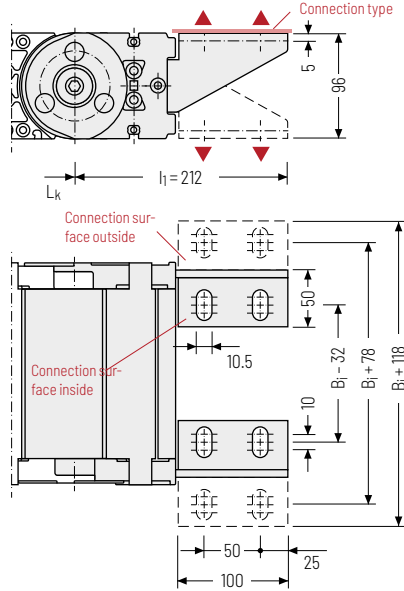

 Assembly options

Connection point

F – fixed point
M – driver

Connection type

U – universal end connector

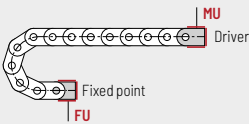

Connection point

F – fixed point
M – driver

Connection surface

A – connection surface outside
I – connection surface inside

Connection type

A – threaded joint outside (standard)
I – threaded joint inside
F – flange connection

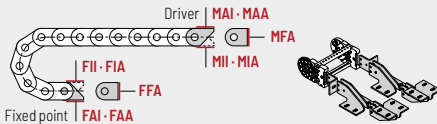

Order example

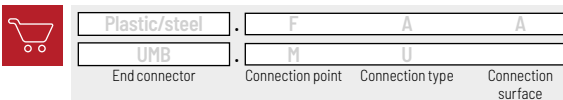

 We recommend the use of strain reliefs at the driver and fixed point. See from p. 904.

MT1300



Pitch
130 mm



Inner height
87 mm



Inner widths
100 – 800 mm



Bending radii
240 – 500 mm

Stay variants



Aluminum cover RMD page 626

Solid cover

- » Aluminum cover system for heavy loads and maximum cable carrier widths. Threaded joint on both sides.
- » **Outside/inside:** threaded joint easy to release.



TOTALTRAX® complete systems

Benefit from the advantages of the TOTALTRAX® complete system. A complete delivery from one source – with a warranty certificate on request! Learn more at tsubaki-kabelschlepp.com/totaltrax



TRAXLINE® cables for cable carriers

Hi-flex electric cables which were especially developed, optimized and tested for use in cable carriers can be found at tsubaki-kabelschlepp.com/traxline

Unsupported arrangement

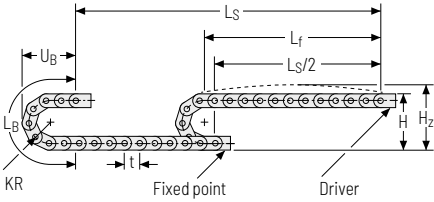

KR [mm]	H [mm]	H ₂ [mm]	L _B [mm]	U _B [mm]
240	660	720	1014	430
280	740	800	1140	470
320	820	880	1266	510
360	900	960	1391	550
400	980	1040	1517	590
500	1180	1240	1831	690

Load diagram for unsupported length

depending on the additional load.

Sagging of the cable carrier is technically permitted for extended travel lengths, depending on the specific application.

Intrinsic cable carrier weight $q_k = 8.0 \text{ kg/m}$. For other inner widths, the maximum additional load changes.

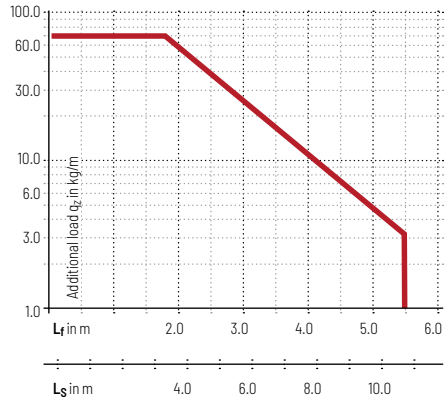



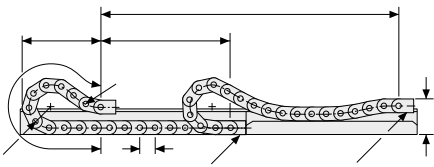

-  **Speed**
up to 10 m/s
-  **Acceleration**
up to 20 m/s²
-  **Travel length**
up to 10.8 m
-  **Additional load**
up to 70 kg/m

Gliding arrangement | GO module with chain links optimized for gliding



KR [mm]	H [mm]	GO module RKR [mm]	L _B [mm]	U _B [mm]
240	360	500	2470	1125
320	360	500	2880	1240
360	360	500	3140	1331
500	360	500	4310	1756

-  **Speed**
up to 8 m/s
-  **Acceleration**
up to 20 m/s²
-  **Travel length**
up to 300 m
-  **Additional load**
up to 70 kg/m

 The gliding cable carrier must be guided in a channel. See p. 844.

The GO module mounted on the driver is a defined sequence of 4 adapted KR/RKR link plates.

Glide shoes have to be used for gliding applications.

MT series
XLT series
ROBOTRAX® System
FLATVEYOR®
CLEANVEYOR®
LS/LSX series
S/SX series
S/SX-Tubes series
Accessories
TRAXLINE®

Aluminum cover RMD – Solid cover

- » Aluminum cover system for heavy loads and maximum cable carrier widths. Threaded joints on both sides.
- » Available customized in **1 mm sections**.
- » **Outside/inside:** threaded joint easy to release.



Stay arrangement on each chain link (**VS: fully-stayed**)



1 mm B_i 100 – 800 mm
in 1 mm width sections

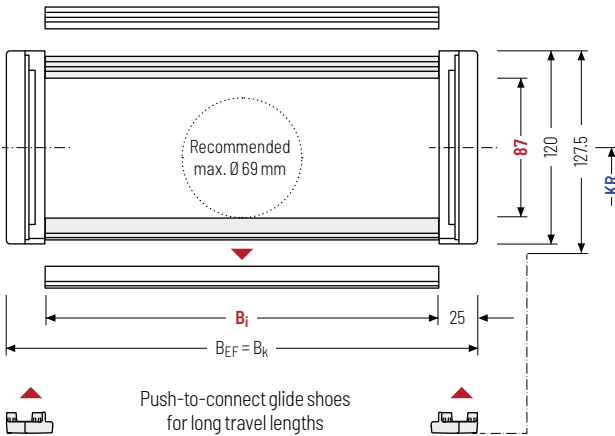

The maximum cable diameter strongly depends on the bending radius and the desired cable type. Please contact us.

Calculating the cable carrier length

Cable carrier length L_k

$$L_k \approx \frac{L_S}{2} + L_B$$

Cable carrier length L_k
rounded to pitch t

h _i [mm]	h _G [mm]	h _{G'} [mm]	B _i [mm]*	B _k [mm]	B _{EF} [mm]	KR [mm]				q _k [kg/m]		
87	120	127,5	100 – 800	B _i + 50	B _i + 50	240	280	320	360	400	500	8.80 – 27.40

* in 1 mm width sections

Order example



MT1300

Type

360

B_i [mm]

RMD

Stay variant

360

KR [mm]

2600

L_k [mm]

VS

Stay arrangement

Divider systems

As a standard, the divider system is mounted on every 2nd chain link.

For applications with lateral acceleration and lying on the side, the dividers can be attached by simple insertion of a fixing profile into the RMD stay, available as an accessory (**version B**).

As a standard, dividers or the complete divider system (dividers with height separations) are movable in the cross section (**version A**).

Divider system TS0 without height separation

Vers.	a _T min [mm]	a _x min [mm]	a _c min [mm]	a _x grid [mm]	π _T min
A	12	15	10	-	-
B	15	15	10	5	-

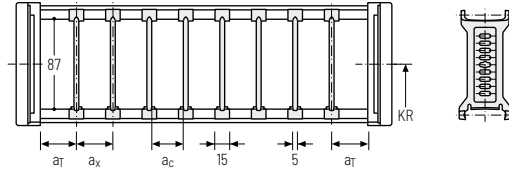

Divider system TS1 with continuous height separation

Vers.	a _T min [mm]	a _T max [mm]	a _x min [mm]	a _c min [mm]	a _x grid [mm]	π _T min
A	12	25	15	10	-	2
B	15	25	15	10	5	2

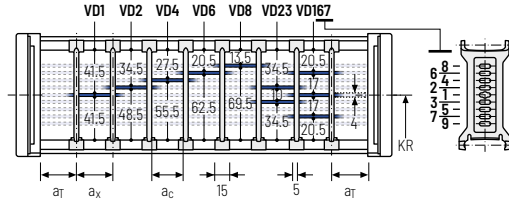

Divider system TS3 with partial height separation

Vers.	a _T min [mm]	a _x min [mm]	a _c min [mm]	π _T min
A	12	16/42*	8	2

* For aluminum partitions

With grid distribution (1 mm grid). The dividers are attached by the height separation, the grid can be moved in the cross section.

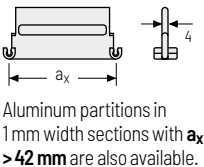
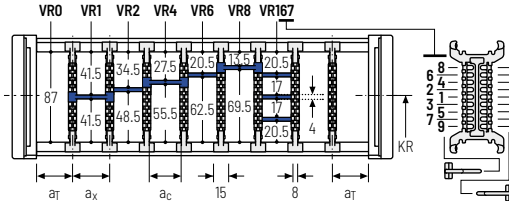

a _x (center distance of dividers) [mm]											
a _c (nominal width of inner chamber) [mm]											
16	18	23	28	32	33	38	43	48	58	64	68
8	10	15	20	24	25	30	35	40	50	56	60
78	80	88	96	112	128	144	160	176	192	208	
70	72	80	88	104	120	136	152	168	184	200	

When using plastic partitions with a_x > 112 mm, we recommend an additional center support with a twin divider (S_T = 5 mm). Twin dividers are also suitable for retrofitting in the partition system.

MT series
 XLT series
 ROBOTRAX® System
 FLATVEVOR®
 CLEANVEVOR®
 LS/LSX series
 S/SX series
 S/SX-Tubes series
 Accessories
 TRAXLINE®

Universal end connectors UMB – plastic (standard)

The universal end connectors (UMB) are made from plastic and can be mounted **from the top, from the bottom, face on or from the side.**

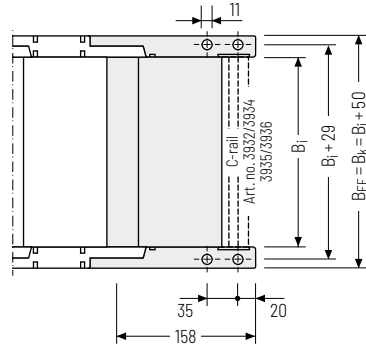
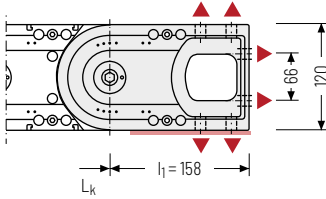

▲ Assembly options



Recommended tightening torque: 54 Nm
for cheese-head screws ISO 4762 - M10 - 8.8

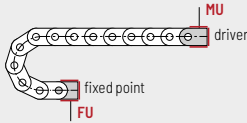

Connection point

F – fixed point
M – driver

Connection type

U – Universal mounting bracket

Order example



UMB	·	F	A
UMB	·	M	A
End connector		Connection point	Connection type



We recommend the use of strain reliefs at the driver and fixed point. See from p. 904.

More product information online



Assembly instructions etc.:
Additional info via your
smartphone or check online at
[tsubaki-kabelschlepp.com/
downloads](http://tsubaki-kabelschlepp.com/downloads)



Configure your custom
cable carrier here:
online-engineer.de

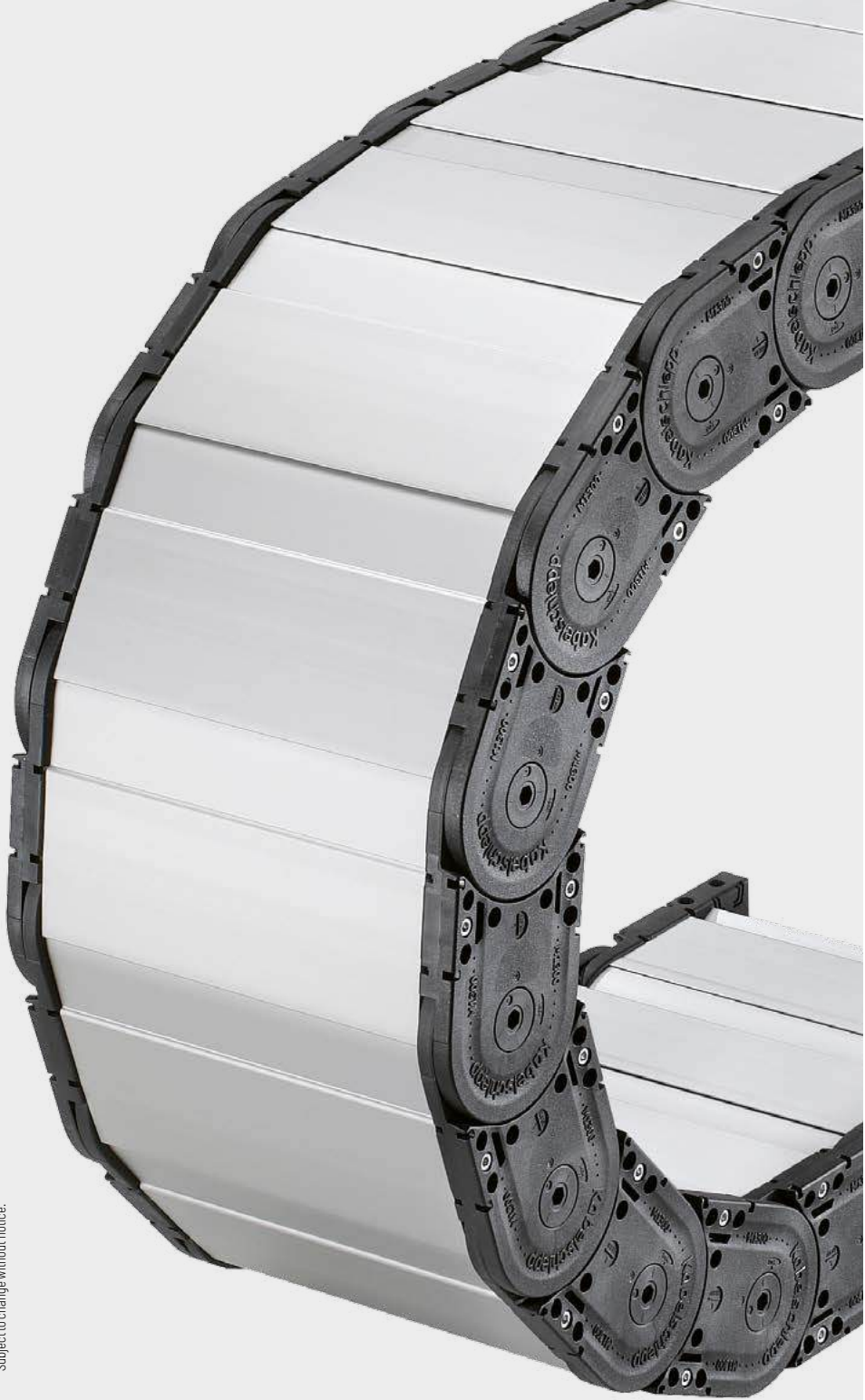

XLT series

**Tubes with variable
cable carrier widths**

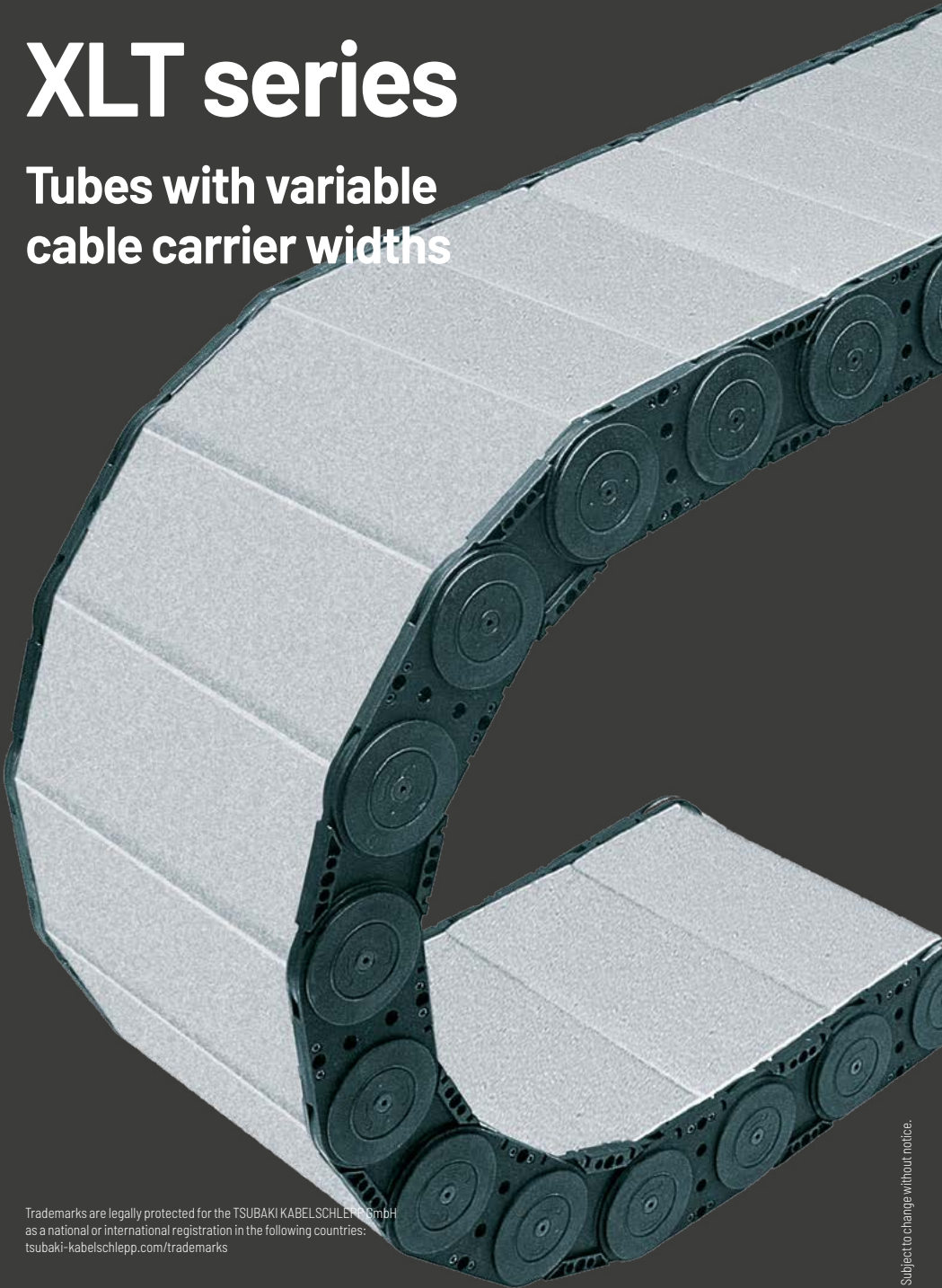

Trademarks are legally protected for the TSUBAKI KABELSCHLEPP GmbH as a national or international registration in the following countries:
tsubaki-kabelschlepp.com/trademarks

Subject to change without notice.

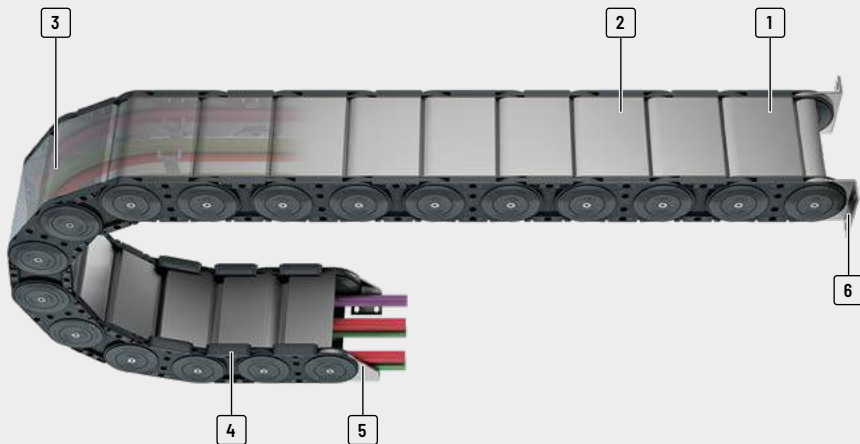

- 1 Aluminum covers available in **1 mm width sections**
- 2 4 screw-fixing points for extreme loads
- 3 Can be opened on the inside and the outside for installation of cables and hoses
- 4 Replaceable glide shoes
- 5 Sturdy end connectors made of steel
- 6 Flange connection

Features

- » Sizes/dimensions
- » Low intrinsic weight
- » Optimum force transmission via the large-surface stroke system (2 disc principle)
- » Plastic side bands in combination with aluminum stays
- » Versions with aluminum stays available in 1 mm width sections up to 1000 mm inner width
- » Can be opened on both sides
- » Large selection of separating options for cables and hoses
- » Optionally with strain relief

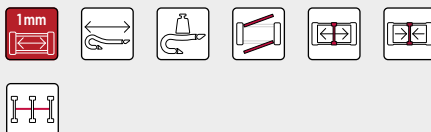

Bolted covers systems for maximum stability even for large cable carrier widths



Replaceable glide shoes for long service life for gliding applications



Sturdy end connectors made of steel (different connection variants)



Many separation options for the cables

MT
seriesXLT
seriesROBOTRAX®
System

FLATVEYOR®

CLEANVEYOR®

LS/LSX
seriesS/SX
seriesS/SX-Tubes
series

Accessories

TRAXLINE®

Type	Opening variant	Stay variant	h_i [mm]	h_G [mm]	B_i [mm]	B_k [mm]	B_i - grid [mm]	t [mm]	KR [mm]	Additional load ≤ [kg/m]	Cable- d_{max} [mm]
XLT1650											
		RMD	105	140	200 - 1000	268 - 1068	1	165	300 - 550	65	84

Unsupported arrangement			Gliding arrangement			Inner Distribution				Movement			Page
Travel length ≤ [m]	v_{max} ≤ [m/s]	a_{max} ≤ [m/s ²]	Travel length ≤ [m]	v_{max} ≤ [m/s]	a_{max} ≤ [m/s ²]	TS0	TS1	TS2	TS3	vertical hanging or standing	lying on the side	rotating arrangement	

11.75	4	25	350	2	2-3	•	-	-	•	•	•	-	636
-------	---	----	-----	---	-----	---	---	---	---	---	---	---	-----

Subject to change without notice.

MT series

XLT series

ROBOTRAX® System

FLATVEYOR®

CLEANVEYOR®

LS/LSX series

S/SX series

S/SX-Tubes series

Accessories

TRAXLINE®

XLT1650



Pitch
165 mm



Inner heights
105 mm



Inner widths
200 - 1000 mm



Bending radii
300 - 550 mm

Stay variants



Aluminum stay RMD page **636**

Aluminum cover system

- » Bolted aluminum covers for maximum stability
- » For applications generating swarf or coarse contamination
- » **Inside/outside:** Threaded joint easy to release.

Unsupported arrangement

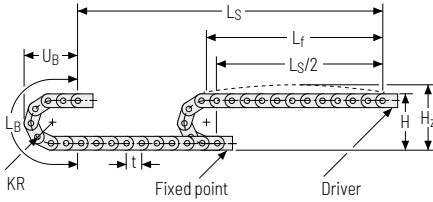





KR [mm]	H [mm]	H _z [mm]	L _B [mm]	U _B [mm]
300	740	840	1272	535
350	840	940	1430	585
400	940	1040	1587	635
450	1040	1140	1744	685
500	1140	1240	1901	735
550	1240	1340	2058	785

Load diagram for unsupported length depending on the additional load.

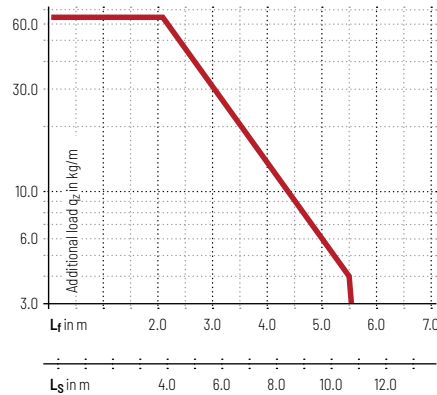
Sagging of the cable carrier is technically permitted for extended travel lengths, depending on the specific application.





Intrinsic cable carrier weight $q_k = 13 \text{ kg/m}$. For other inner widths, the maximum additional load changes.

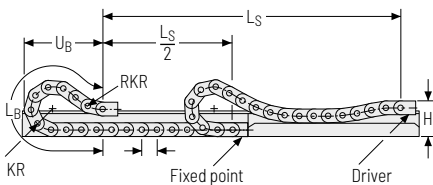

-  **Speed**
up to 4 m/s
-  **Acceleration**
up to 25 m/s²
-  **Travel length**
up to 11.75 m
-  **Additional load**
up to 65 kg/m

Gliding arrangement



-  **Speed**
up to 2 m/s
-  **Acceleration**
up to 2-3 m/s²
-  **Travel length**
up to 350 m
-  **Additional load**
up to 65 kg/m

 The gliding cable carrier must be guided in a channel. See p. 844.

We recommend the use of glide shoes for gliding applications.

Aluminum stay RMD – aluminum cover system

- » Bolted aluminum covers for maximum stability
- » For applications generating swarf or coarse contamination
- » Available customized in **1 mm grid**.
- » **Inside/outside:** Threaded joint easy to release.



Stay arrangement on each chain link (**VS: fully-stayed**)



1 mm B_i: 200 – 1000 mm
in 1 mm width sections

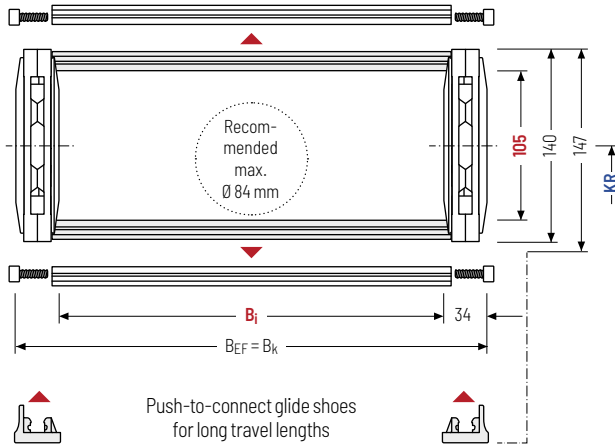

The maximum cable diameter strongly depends on the bending radius and the desired cable type. Please contact us.

Calculating the cable carrier length

Cable carrier length L_k

$$L_k \approx \frac{L_S}{2} + L_B$$

Cable carrier length L_k rounded to pitch t

h_j [mm]	h_g [mm]	h_g' [mm]	B _i [mm]*	B _k [mm]	B _E F [mm]	KR [mm]		q _k [kg/m]
105	140	147	200 – 1000	B _i + 68	B _i + 68	300	350 400 450 500 550	10.5 – 15.3

* in 1 mm width sections

Order example



XLT1650

Type

420

B_i [mm]

RMD

Stay variant

350

KR [mm]

2850

L_k [mm]

VS

Stay arrangement

Divider systems

The divider system is mounted on each crossbar as a standard – on every 2nd chain link for stay mounting (HS).

As a standard, dividers or the complete divider system (dividers with height separations) are movable in the cross section (**version A**).

Divider system TSO without height separation

Vers.	a _T min [mm]	a _x min [mm]	a _c min [mm]	n _T min
A	6	25	17	-

The dividers can be moved in the cross section.

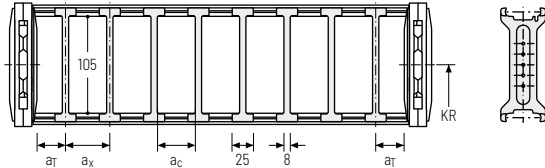

Divider system TS3 with height separation consisting of plastic partitions

Vers.	a _T min [mm]	a _x min [mm]	a _c min [mm]	n _T min
A	1	16 / 42*	8	2

* For aluminum partitions

The dividers are fixed with the partitions. The entire divider system can be moved in the cross section.

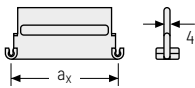
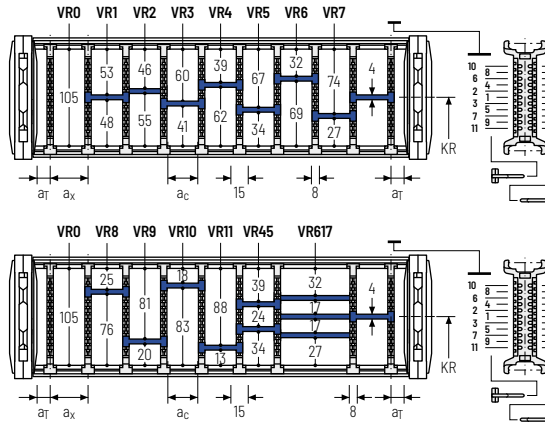

Aluminum partitions in 1 mm increments with a_x > 42 mm are also available.

a _x (center distance of dividers) [mm]											
a _c (nominal width of inner chamber) [mm]											
16	18	23	28	32	33	38	43	48	58	64	68
8	10	15	20	24	25	30	35	40	50	56	60
78	80	88	96	112	128	144	160	176	192	208	
70	72	80	88	104	120	136	152	168	184	200	

When using plastic partitions with a_x > 112 mm, we recommend an additional center support with a twin divider (S_T = 5 mm). Twin dividers are also suitable for retrofitting in the partition system.

Order example

.
TS3

.
A

.
3

.
K1

.
34

-
VR1

⋮

⋮

⋮

.
K4

.
38

-
VR3

Divider system

Version

n_T

Chamber

a_x

Height separation

Please state the designation of the divider system (**TS0, TS3**), the version, and the number of dividers per cross section [n_T]. In addition, please also enter the chambers [K] from left to right, as well as the assembly distances [a_T/a_x].

End connectors - steel

End connectors made of steel. The connection variants on the fixed point and on the driver can be combined and changed later on, if necessary.

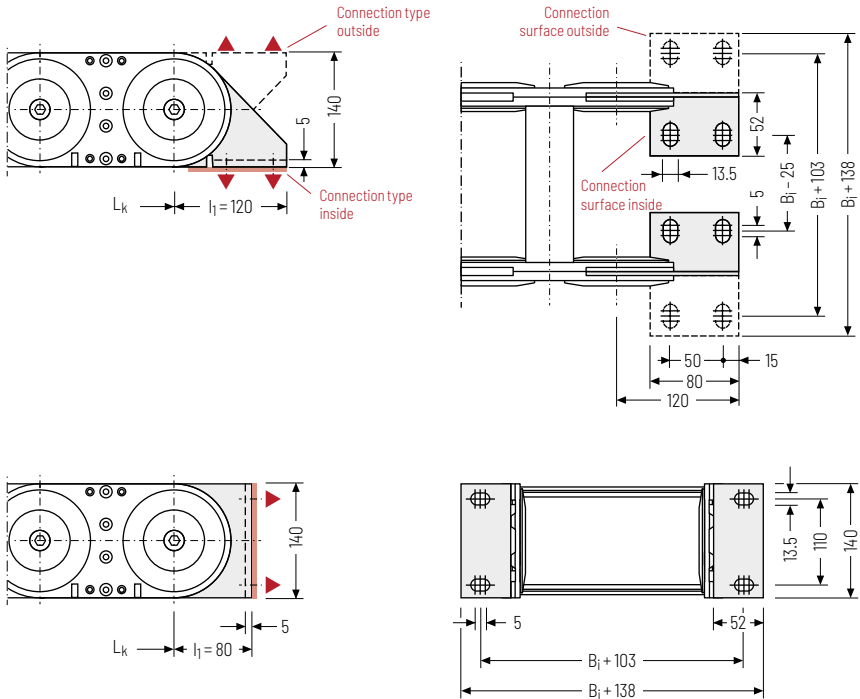

▲ Assembly options

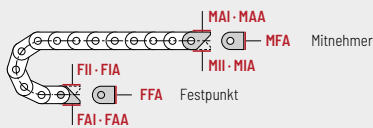

Connection point

F - fixed point
M - driver

Connecting surface

A - connecting surface outside
I - connecting surface inside

Connection type

A - threaded joint outside (standard)
I - threaded joint inside
F - flange connection

Order example



Steel	F	A	I
Steel	M	A	I
End connector	Connection point	Connection type	Connecting surface



We recommend the use of strain reliefs at the driver and fixed point. See from p. 904.

Subject to change without notice.



TRAXLINE®

Accessories

S/SX-Tubes
series

S/SX
series

LS/LSX
series

CLEANVEYOR®

FLATVEYOR®

ROBOTRAX®
System

XLT
series

MT
series

MT
seriesXL
seriesROBOTRAX®
System

FLATVEYOR®

CLEANVEYOR®

LS/LSX
seriesS/SX
seriesS/SX-Tubes
series

Accessories

TRAXLINE®

3D-LINE

Cable carriers for 3D applications

Multidimensional rotation and swivel motions require cable carriers that follow the movements reliably while securely guiding and protecting cables and hoses. The cable carriers from the 3D-Line combine these special characteristics and are therefore particularly suitable for applications in robotics and automation.

- » Ideal for maximum freedom of movement for 3D applications
- » Three-dimensional swivel and rotation movements, for example on robots for use from robot base to robot wrist
- » Extending the service life of cables in 3D applications through defined minimum bending radius and separation and guiding of the cables
- » For extremely high tensile forces and accelerations

Not all technical data and parameters are reached in each individual case, but are depending on the respective type of application and product configuration. Legally binding insofar as only the individual information provided for the specifically requested particular case. Please contact us - we will be happy to advise you!

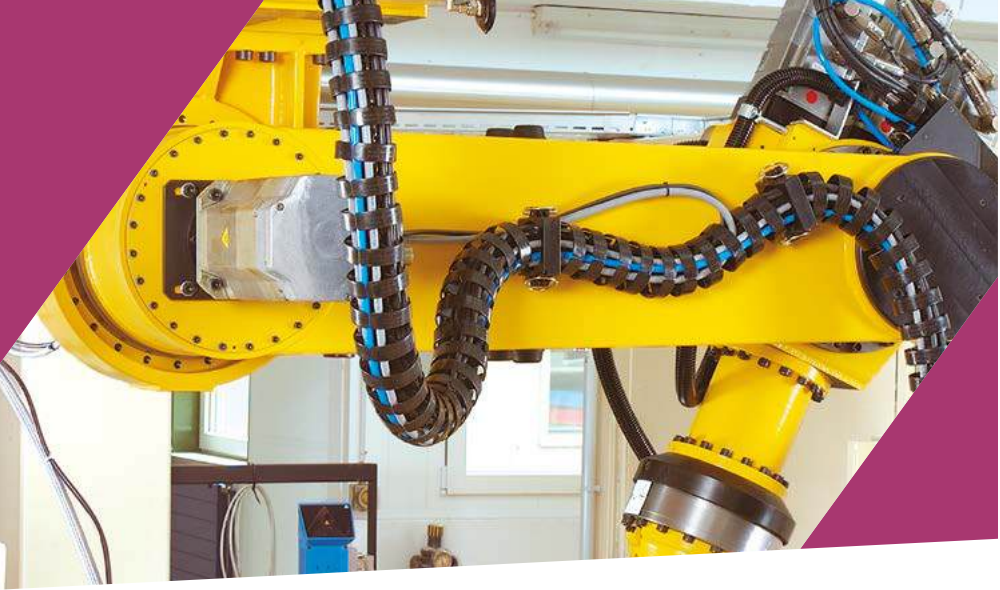

ROBOTRAX® System Page 670
 Cable carrier for 3D movements

MT series

XLT series

ROBOTRAX® System

FLATVEYOR®

CLEANVEYOR®

LS/LSX series

S/SX series

S/SX-Tubes series

Accessories

TRAXLINE®

ROBOTRAX® System

Cable carrier for
3D movements

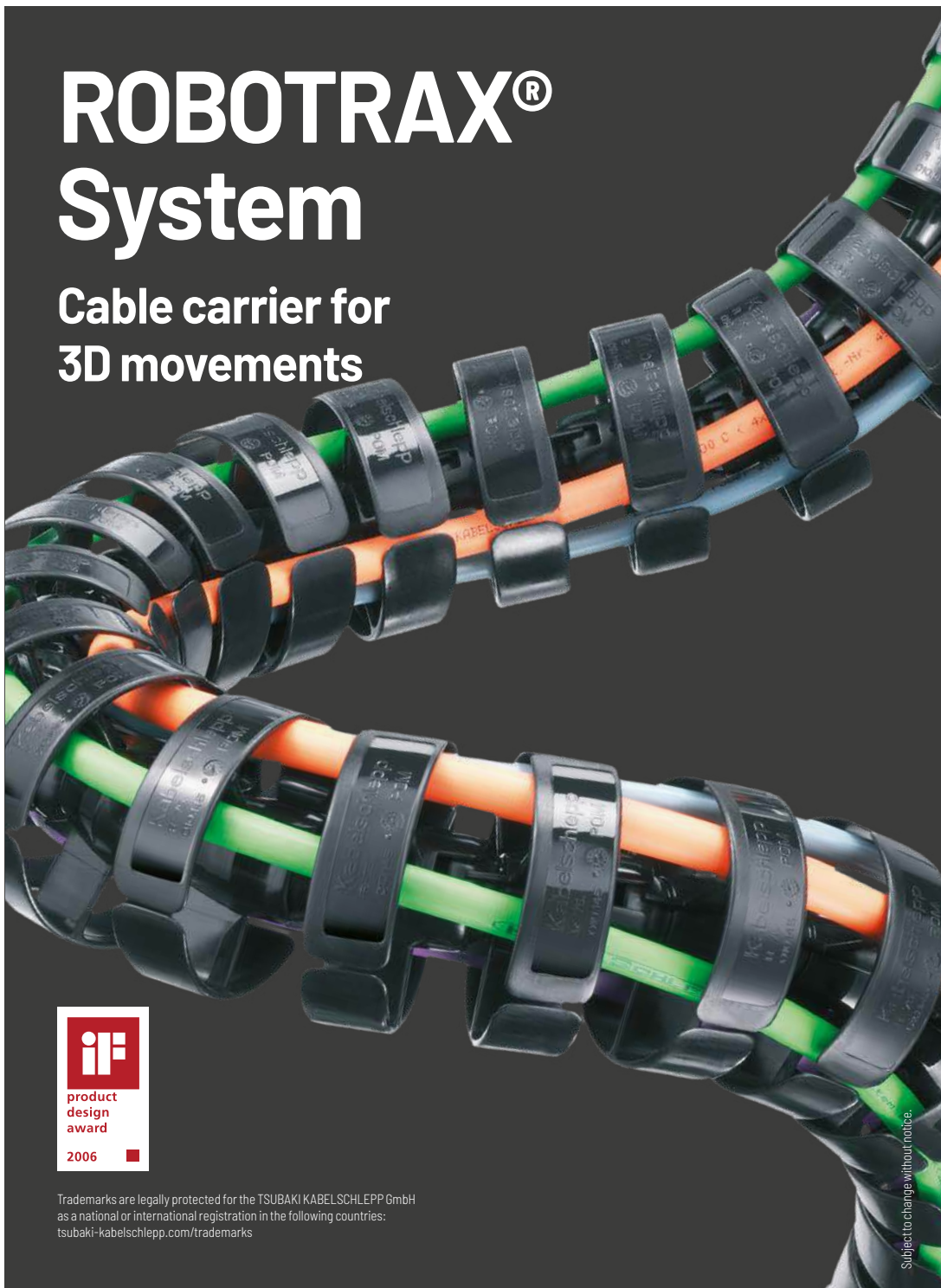

product
design
award

2006

Trademarks are legally protected for the TSUBAKI KABELSCHLEPP GmbH
as a national or international registration in the following countries:
tsubaki-kabelschlepp.com/trademarks

Subject to change without notice.

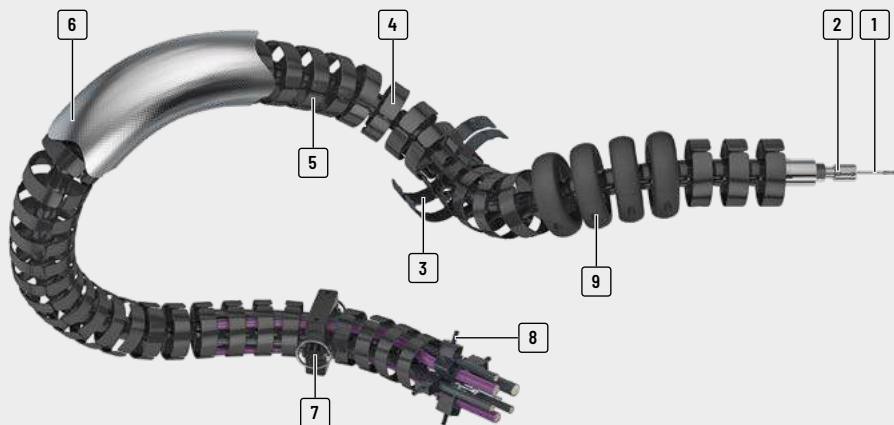

- 1 Steel cable for transferring extremely high tensile forces
- 2 Tension piece for locking the chain links
- 3 Type with toolless opening swivel crossbars and divider module available
- 4 Open design
 - Fast cable laying as the cables are simply pressed in
 - Easy checking of all cables
- 5 Special plastic for long service life
- 6 Protective covers or heat shields made from different materials are available for different environmental conditions
- 7 Quick-release bracket for fixing and continuation
- 8 Strain relief with LineFix clamps
- 9 Protection against hard impacts, excessive abrasion and premature wear as well as limitation of the bending radius through protector

Features

- » Suitable for three-dimensional swivel and rotation movements
- » Ideal for a long service life of the cables:
 - The bending radius does not fall below the minimum when using protectors
 - The cables can be separated in three chambers
- » Also ideal for turntables



Swiveling crossbars and divider module (R140X)



Active return mechanism with the PBU pull back unit (R040 – R100)



Fast cable laying by simply pressing in the cables (R040 – R100)



Strain relief for secure fixing of the cables

MT series

XLT series

ROBOTRAX® System

FLATVEYOR®

CLEANVEYOR®

LS/LSX series

S/SX series

S/SX-Tubes series

Accessories

TRAXLINE®

Type	Opening variant	h_i [mm]	B_i [mm]	D_a [mm]	t [mm]	KR [mm]	Radial link rotation on 1 m length [°]	Additional load \leq [kg/m]	Cable- d_{max} [mm]	Page	
MT series											
XL-T series	R040		10	27	40	21,5	70 [75]	± 450	0,7	8,5	646
ROBOTRAX® System	R056		14	39	56	32	90 [105]	± 300	1,1	11	646
FLATVEYOR®	R075		22	52	75	40	125 [140]	± 215	4	18	646
CLEANVEYOR®	R085		24	54	85	40	130 [170]	± 215	5	20	646
LS/LSX series	R100		31	64	100	40	130 [175]	± 215	6	27	646

Values in [] apply when using protectors

Type	Opening variant	h_i [mm]	B_i [mm]	D_a [mm]	t [mm]	KR [mm]	Radial link rotation on 1 m length [°]	Additional load \leq [kg/m]	Cable- d_{max} [mm]	Page	
S/SX-Tubes series											
Accessories	R140X		48	74	140	50	125 [225]	± 200	10	42	647

Values in [] apply when using protectors



Subject to change without notice.

MT series

XLT series

ROBOTRAX® System

FLATVEYOR®

CLEANVEYOR®

LS/LSX series

S/SX series

S/SX-Tubes series

Accessories

TRAXLINE®

ROBOTRAX®

MT
seriesXLT
seriesROBOTRAX®
System

FLATVEYOR®

CLEANVEYOR®

LS/LSX
seriesS/SX
seriesS/SX-Tubes
series

Accessories

TRAXLINE®

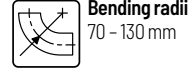

Chain links single part

The basic structure of ROBOTRAX® consists of plastic links. These have spherical snap-on connections on both sides. This allows the individual links to be snapped together to form a cable carrier.

Protectors ensure that the bending radius does not fall below the minimum in any direction. The links can be rotated in the radial direction (see table values). The cables can be separated in three chambers.

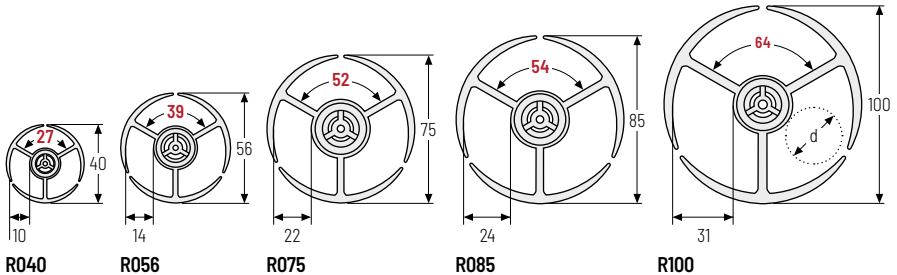

Dimensions

Type	t [mm]	KR [mm]	Radial rotation possible on 1 m length [°]	d* [mm]	Number of links per m
R040	21.5	70 [75]	± 450	2 - 8.5	47
R056	32	90 [105]	± 300	2 - 11	31
R075	40	125 [140]	± 215	3 - 18	25
R085	40	130 [170]	± 215	3 - 20	25
R100	40	130 [175]	± 215	3 - 27	25

Values in [] apply when using protectors

*We recommend a maximum cable diameter of 70 % of the highest specified value

Order example



* Type 010: cables are simply pressed in

Calculating the cable carrier length

Cable carrier length L_k

$$L_k = n \times t$$



Pitch
50 mm



Inner height
48 mm



Inner width
74 mm



Bending radius
125 mm

Chain links with crossbars

The basic construction is similar to the ROBOTRAX® types with single part design. Swiveling crossbars with snap locks make it easy to open and safely close the cable carrier. In addition, the three chambers can be divided horizontally and vertically by a divider module for precisely separating cables and hoses.

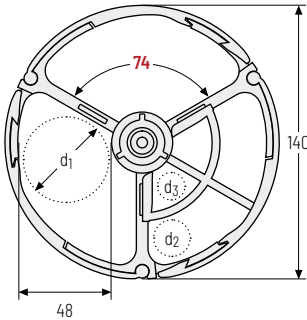

R140X

Dimensions and order

Type	t [mm]	KR [mm]	Radial rotation possible on 1 m length [°]	d ₁ [mm]	d ₂ [mm]	d ₃ [mm]	Number of links per m
R140X	50	125 [225]	± 200	42	18	15	20

Values in [] apply when using protectors

Order example



R140X . **030** . **125** - **1500**
Type Design* KR [mm] L_k [mm]

* Type 030: Outside opening crossbars

Calculating the cable carrier length

Cable carrier length L_k

$$L_k = n \times t$$

MT series

XLT series

ROBOTRAX® System

FLATVEYOR®

CLEANVEYOR®

LS/LSX series

S/SX series

S/SX-Tubes series

Accessories

TRAXLINE®

Mounting kit

Fast movements of the robot arms generate high accelerations and therefore high tensile forces on the cable carrier.

To transfer these tensile forces, ROBOTRAX® has a hole at the center of each chain link through which the steel cable is pulled. This steel cable takes on the function of force transmission.

The steel cable is fixed with a clamping piece on one side. ROBOTRAX® permits accelerations up to 10 g.

The clamping piece can be used to easily set the chain links to the desired tension and adjust them at any time.

Long service life of the cables and hoses:

The forces are primarily transmitted by the cable carrier and not by cables and hoses.

The mounting set consists of steel cable, clamping and tension piece for up to 5 m cable carrier length.



Quick-release brackets

The ROBOTRAX® is fixed and continued with quick-release brackets which are attached with screws. The quick-release brackets fit on any chain link of the respective size. This means the fixing points can be individually adjusted to the motion sequence.

Locking bolt:

100% recyclable, cost-effective locking bolt, optimized for installation space and environment. The bolt can be assembled and disassembled without tools. (Also available as a screwed version)



Dimensions

	R040	R056	R075	R085	R100	R140X
h_1 [mm]	54	70	86	105	120	164
h_2 [mm]	15	22	28	30	32	50
l_2 [mm]	-	-	-	-	-	20
b_1 [mm]	82	86	110	133	150	197.4
b_2 [mm]	50	63	82	96	112	158
b_3 [mm]	36	48	64	72	70	70
b_4 [mm]	18	24	32	36	35	35
b_5 [mm]	-	-	-	-	-	32
Screws	2xM4	2xM4	2xM6	2xM8	2xM8	4xM8

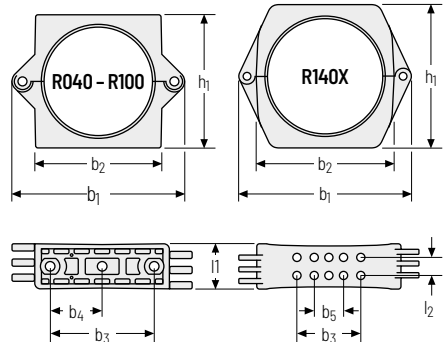

Please state the desired type series and quantity when ordering.

Heat shield/protective cover

Heat shield: The heat shield made from aluminum-coated textile fibers protects the ROBOTRAX® system and inserted cables against flying sparks, weld spatter and radiated heat.

Protective cover: The protective cover made from coated polyester protects against aggressive cutting fluids, hydraulic oils, fine dust and paint spatter.



 Please state the desired type series and quantity when ordering.

MT series
XLT series
ROBOTRAX® System

Strain relief for cable ties

(available for all types)
For secure fixing of the cables.
The strain relief can be used on either end.



 Please state the desired type series and quantity when ordering.

FLATVEVOR®
CLEANVEVOR®
LS/LSX series

Strain relief LFR

(for types R075, R085, R100 and R140X)
Secure cable fixing, gentle on the cables.
Multi-layer cable fixing is also possible with double and triple LineFix® clamps. Several systems can be installed in sequence.
LineFix® strain reliefs – see page 906.



 Please state the desired type series and quantity when ordering.

S/SX series
S/SX-Tubes series
Accessories

TRAXLINE®

PBU pull back unit

(for types R040, R056, R075, R085 and R100)



Please state the number, robot type and type series when ordering.

PBU: With fast movement sequences and large work envelopes, the relatively long carriers knock against the robot arm. The repeated impact significantly reduces the service life of the cable carrier and the cables within, and the entire system can fail. Downtimes cause high costs and problems in the manufacturing process – so they have to be avoided.

- » Compact design: fewer interfering contours and lower risk of collision
- » Maximum flexibility for cable carrier routing
- » No maintenance on the retraction element required
- » Standard mounting for KUKA, ABB and FANUC

PBU is available for new robots, regardless of size, manufacturer, type or application, as well as retrofits and upgrades for existing workcells. It can be mounted vertically, horizontally or upside down. The extension length of the LSH 3 is 350 mm.

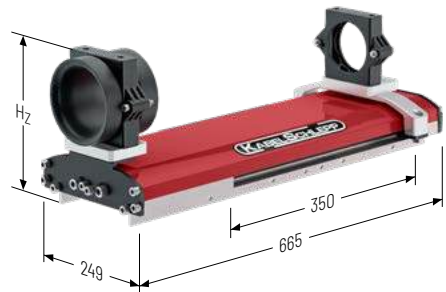

	R040	R056	R075	R085	R100
H_z [mm]	187	187	221	221	268
Type	Fotensile forces F [N]				
PBU Light	40.0				
PBU Standard	80.0				
PBU Heavy	110.0				

Protector

The service life of the cable carriers and cables is significantly reduced by impact during fast movement sequences and in large work envelopes. The Protector protects the cable carrier against hard impacts, excessive abrasion and premature wear, while also acting as a limitation for the smallest bending radius. Downtimes are minimized. Not the entire cable carrier has to be replaced, but only the Protector in some cases.



Please state the desired type series and quantity when ordering.

Turntable for quick-release bracket

One additional degree of freedom on the attachments points. When mounted on a turntable, the quick-release bracket can rotate as well, to offer increased flexibility during complex robot movements.



Dimensions

	R040	R056	R075	R085	R100	R140X
A [mm]	57	65	82	96	112	96
B [mm]	57	57	57	70	70	70
C [mm]	43	43	43	75	75	70
D [mm]	43	43	43	45	45	20
E [mm]	36	48	64	72	70	-
F [mm]	-	-	-	-	-	8
H [mm]	27.5	27.5	27.5	34	34	43
d ₁ [mm]	M6	M6	M6	M6	M6	M8
d ₂ [mm]	M4	M4	M6	M8	M8	-
d ₃ [mm]	-	-	-	-	-	14
d ₄ [mm]	-	-	-	-	-	20

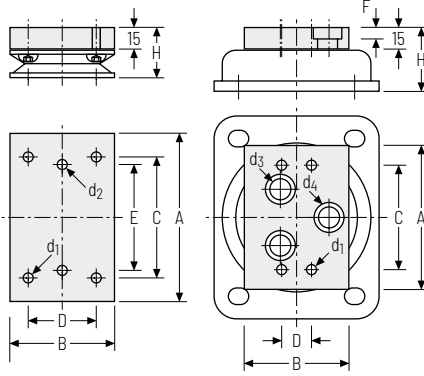

Please state the desired type series and quantity when ordering.

Set consisting of



Coil spring for quick-release bracket

If the quick-release bracket is mounted on a coil spring, it can move elastically in all directions, deflect in 3 dimensions and spring back.



Dimensions

	R040	R056	R075	R085	R100
A [mm]	52	64	82	96	112
B [mm]	36	48	64	72	70
C [mm]	5	5	6.5	8.5	8.5
D [mm]	26	30	34	34	34
L [mm]	110	110	-	-	-
	150	150	-	-	-
	-	-	165	165	165
	-	190	-	-	-
	-	-	230	230	230
	-	-	315	315	315
	-	-	465	465	465

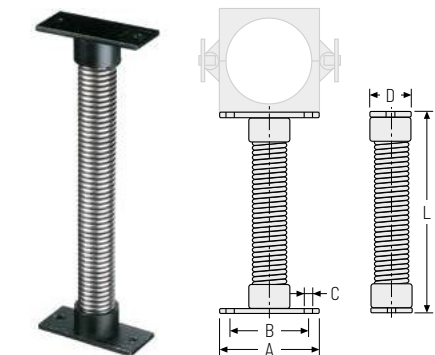

Please state the desired type series and quantity when ordering.

MT series
XLT series
ROBOTRAX® System
FLATVEVOR®
CLEANVEVOR®
LS/LSX series
S/SX series
S/SX-Tubes series
Accessories
TRAXLINE®

MT
series

Special solutions

XLT
series

Cable carriers for special applications

ROBOTRAX®
System

Whether customized solutions or cable carriers for special applications. In the chapter "special solutions" you will find cable carriers for specific requirements with adapted properties such as products for the clean room to protect your cables and hoses.

FLATVEYOR®

- » Practical solutions for special applications
- » Application-dependent individual configuration possible
- » Solutions for use with ISO Class 1 and ISO Class 2

CLEANVEYOR®

LS/LSX
seriesS/SX
seriesS/SX-Tubes
series

Accessories

TRAXLINE®

Not all technical data and parameters are reached in each individual case, but are depending on the respective type of application and product configuration. Legally binding insofar as only the individual information provided for the specifically requested particular case. Please contact us - we will be happy to advise you!

MT
seriesXLT
seriesROBOTRAX®
System

FLATVEYOR®

CLEANVEYOR®

LS/LSX
seriesS/SX
seriesS/SX-Tubes
series

Accessories

TRAXLINE®



FLATVEYOR® Page 682

Cable management system solution
for cleanroom applications



FLATVEYOR® ZP Page 686

Sustainable cable management system solution for clean-
room applications



CLEANVEYOR® Page 690

For highly requirement of cleanroom applications, achieve
to ISO Class 1

FLATVEYOR®

Cable management system solution for cleanroom applications

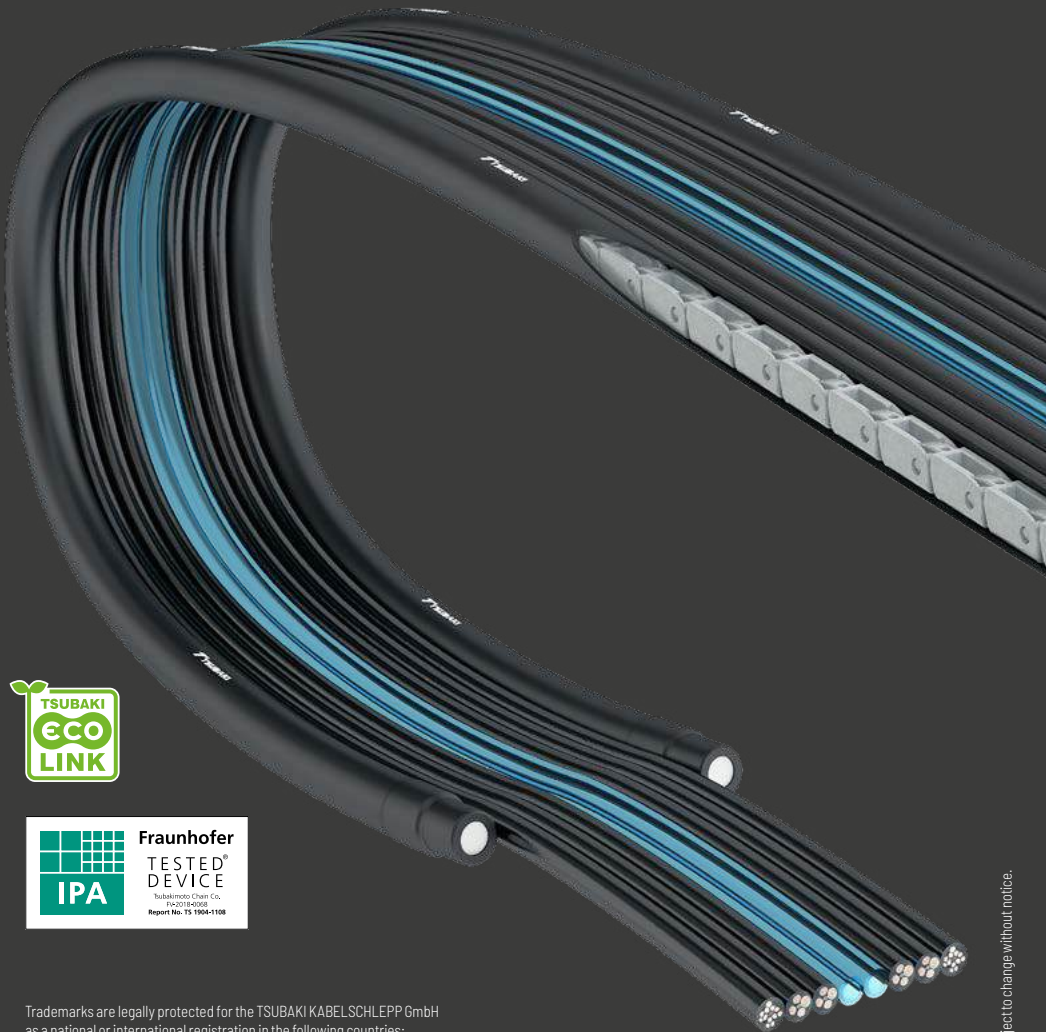

Trademarks are legally protected for the TSUBAKI KABELSCHLEPP GmbH as a national or international registration in the following countries:
tsubaki-kabelschlepp.com/trademarks

Subject to change without notice.



- 1 Flexibility PVC cables from our lineup, based on your specifications
- 2 Polyurethane air tubes, based on your specifications
- 3 Stopper for support members
- 4 Support members on both sides for a free-standing guiding
- 5 Covered tube for support members

Features

- » No friction occurs: Cleanroom IPA ISO Class 2 certified
- » Solve particle issues generated from the friction of cable carriers and cables
- » Usable with long travel strokes
- » Easy to make a clean for maintenance
- » Minimizes bouncing
- » Quiet
- » Compact & lightweight
- » High speed operation
- » Line up cables with excellent flexibility and elasticity

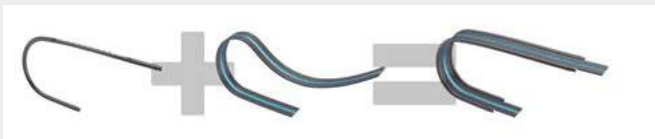

FLATVEYOR® is a free-standing flat cable system with internal support members to keep straight movement with high speed, high acceleration.

MT series

XLT series

ROBOTRAX® System

FLATVEYOR®

CLEANVEYOR®

LS/LSX series

S/SX series

S/SX-Tubes series

Accessories

TRAXLINE®

FLATVEYOR®

FLATVEYOR® is a free-standing flat cable guiding system that makes full use of our cable carrier technology and experience.

From pharmaceutical industry through medical technology to high-tech industry - all of them require an especially low-particle environment and "technical cleanliness" for their production processes. FLATVEYOR® can support to reduce the downtime and improve your productivity.

FLATVEYOR® is a free-standing flat cable system with internal support members to keep straight movement with a high speed.

No hopping, No sagging, No falling over sideways!

The support members act as reliable guides which can be moved in one direction along the intended minimum bending radius, whereby the cables and tubes are guided reliably.



MT
series

XLT
series

ROBOTRAX®
System

FLATVEYOR®

CLEANVEYOR®

LS/LSX
series

S/SX
series

S/SX-Tubes
series

Accessories

TRAXLINE®

Unsupported arrangement

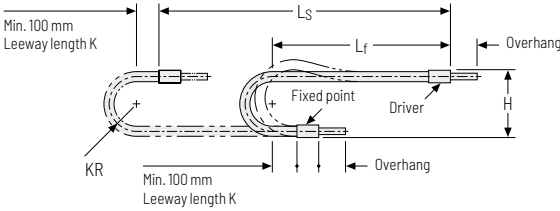

KR [mm]	H [mm]	Travel length* ≤ [mm]
40	103-123	1600
70	213-233	2200
100	273-293	2800
130	333-353	2800

* with an additional load of 0.4 kg/m



Speed
up to 2 m/s



Acceleration
up to 4 m/s²



Temperature range
-10 to 80 °C



Cable-Ø
up to 16 mm

Dimensions

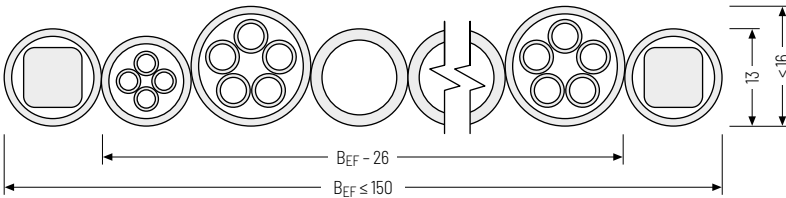

Connection clamps - aluminum

The aluminum clamps can be connected **from above or below**.

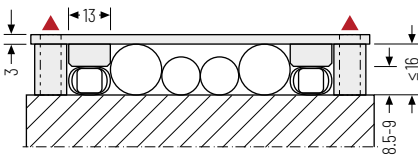

▲ Assembly options

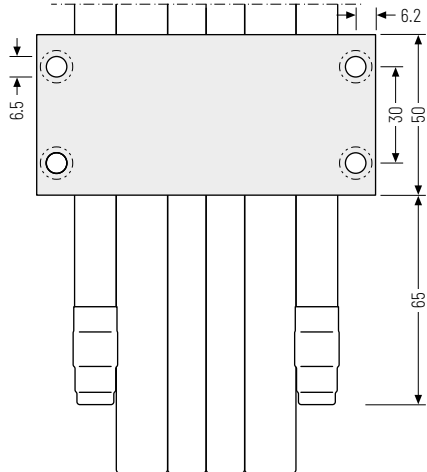

FLATVEYOR® ZP

Sustainable cable management
system solution for cleanroom
applications



Trademarks are legally protected for the TSUBAKI KABELSCHLEPP GmbH
as a national or international registration in the following countries:
[tsubaki-kabelschlepp.com/trademarks](https://www.tsubaki-kabelschlepp.com/trademarks)

Subject to change without notice.

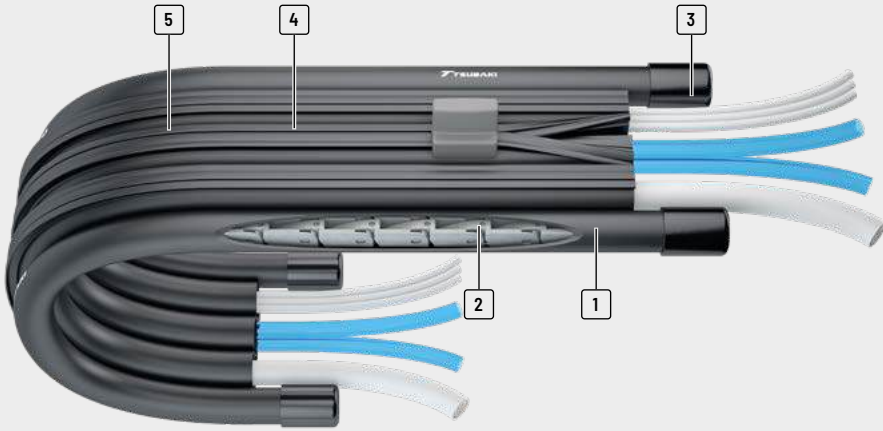

- 1 Openable tubes
- 2 Very easy to close for openable tubes with a supplied tool
- 3 Stopper for support members
- 4 Support members on both sides for a free-standing guiding
- 5 Covered tube for support members

Features

- » No friction occurs: Clean class ISO Class 2 based on in-house test results. Solve particle issues generated from the friction of cable carriers and cables
- » Very easy & convenient to replace and use your own cables and tubes at your site
- » The particularly durable and smoothly moving hoses can be easily opened and closed with the supplied tool
- » Sustainable & Cost down!
- » Cable replacement does not require changing the complete system
- » Quiet
- » Compact & lightweight
- » Specifications can be determined easily and quickly



Easy replacement of cables and hoses



Clean class equivalent to ISO class 2



Available in black or white

FLATVEYOR® ZP

FLATVEYOR® ZP combines the advantages of a FLATVEYOR (flat cable system) with the structure of a cable carrier. FLATVEYOR® ZP reduces the downtime and improves the productivity. Users benefit from a simple replacement process for cables and hoses. In addition, existing cables and hoses can be installed, which reduces costs and provides more sustainability in procurement. There is no need to replace the entire system.

FLATVEYOR® ZP is a free-standing flat cable system with internal support members to keep straight movement with a high speed.

No hopping, No sagging, No falling over sideways!

The support members act as reliable guides which can be moved in one direction along the intended minimum bending radius, whereby the cables and tubes are guided reliably.

About the openable tubes

- » TSUBAKI KABELSCHLEPP's original tube with excellent flexibility, durability and smoothness
- » Zip structure is a very flexible to open and close, but does not open when moving due to the high durability by our original tube
- » 2 Support members with both sides + openable tubes
- » Openable tubes: Selection is available from 1 to 8
- » Color: White or black is a standard model color



Unsupported arrangement

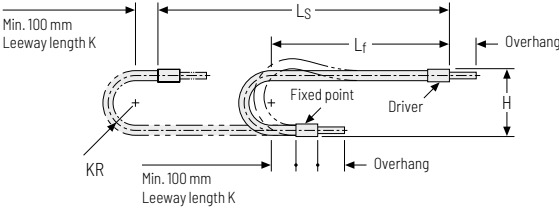

KR [mm]	H [mm]	Travel length* ≤ [mm]
70	223-243	1600
100	283-303	1800
130	343-363	1800

* with an additional load of 0.4 kg/m



Speed
up to 2 m/s



Acceleration
up to 2 m/s²



Temperature range
-10 to 60 °C



Cable-Ø
up to 11 mm

Dimensions

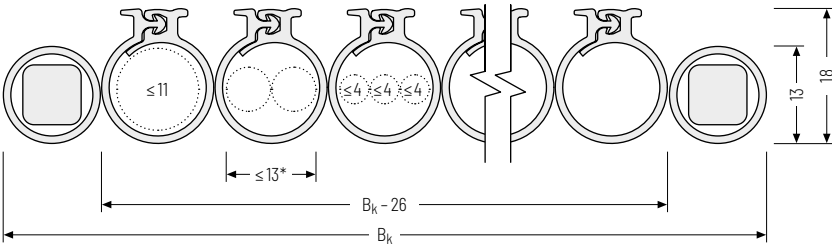

Openable tubes	B _k [mm]	Openable tubes	B _k [mm]	Openable tubes	B _k [mm]	Openable tubes	B _k [mm]
1 tube	41	3 tubes	71	5 tubes	101	7 tubes	131
2 tubes	56	4 tubes	86	6 tubes	116	8 tubes	146

* The difference in outside diameters of adjacent cables and tubes should be 5 mm or less

Connection clamps - aluminum

The aluminum clamps can be connected from above or below.

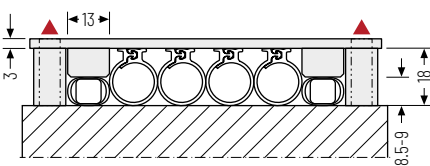

▲ Assembly options

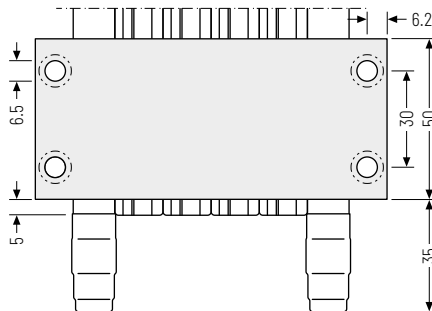

Subject to change without notice.

MT series
XLT series
ROBOTRAX® System
FLATVEYOR®
CLEANVEYOR®
LS/LSX series
S/SX series
S/SX-Tubes series
Accessories
TRAXLINE®

CLEANVEYOR®

For highly requirement of cleanroom applications, achieve to ISO Class 1

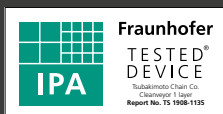

Trademarks are legally protected for the TSUBAKI KABELSCHLEPP GmbH as a national or international registration in the following countries:
tsubaki-kabelschlepp.com/trademarks

Subject to change without notice.

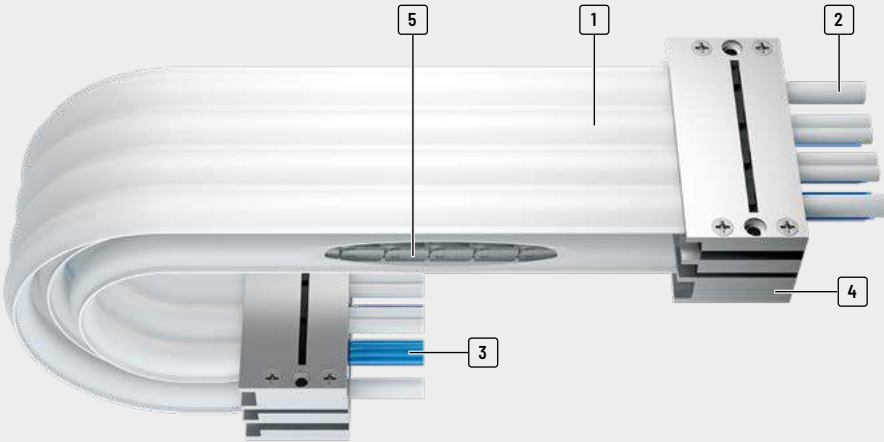

- 1 Pods/Chambers: will select suitable Pods, based on your specifications
- 2 Flexibility cables from our lineup, based on your specifications
- 3 Air tubes, based on your specifications
- 4 Clamp: will select suitable clamp, based on your specifications
- 5 Support members: on both internal sides of Pods for a free-standing guiding

Features

- » Cleanroom IPA ISO Class 1 certified
- » Solve particle issues generated from the friction of cable carriers and cables
- » Usable with long travel strokes
- » Quiet
- » High speed operation
- » Line up cables with excellent flexibility and elasticity
- » Fast installation due to preassembled complete system
- » High durability with over 10 million bending cycles



No friction due to the use of pods



Cleanroom IPA ISO Class 1 certified



High travel speed: up to 2 m/sec

CLEANVEYOR®

CLEANVEYOR® is an extremely top-class solution with a free-standing guiding system that makes full use of our

cable carrier technology and experience.

Maximum purity and hygiene!

It comes as no surprise that clean rooms, processes and products are a must! Because any contamination leads to costly incidents, scrap or useless laboratory results.

CLEANVEYOR® can contribute to lowering total costs, to lead reduction of defective products.

Layering example

CLEANVEYOR® supports a multi-layer structure with up to 6 layers.

1 Layer

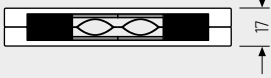

2 layers

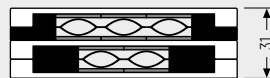

3 layers

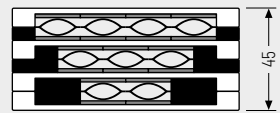

4 layers

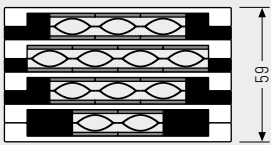

5 layers

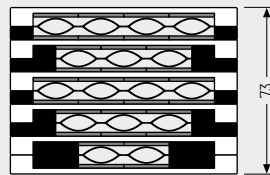

6 layers

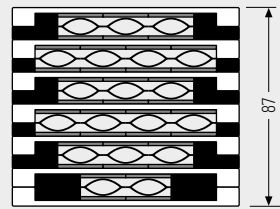

Unsupported arrangement

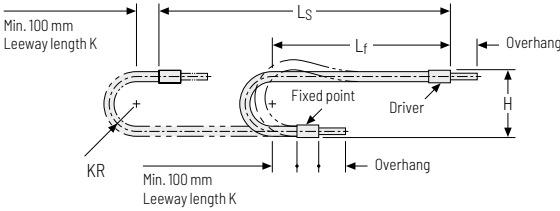

KR [mm]	Travel length* ≤ [mm]
40	1600
70	2200
100	2800
130	2800

* with an additional load of 0.4 kg/m



Speed
up to 2 m/s



Acceleration
up to 4 m/s²



Temperature range
-10 to 80 °C



Cable-Ø
3 to 10 mm

Pod types and dimensions

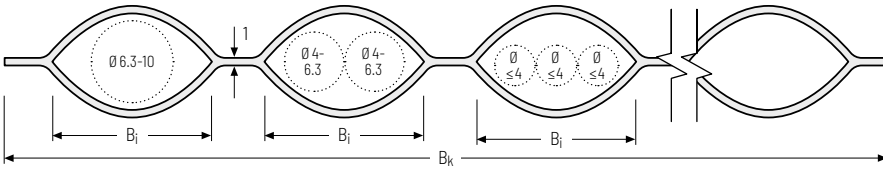

Quantity Pods	Bi [mm]*	Connection width [mm]*	Bk [mm]	Quantity Pods	Bi [mm]*	Connection width [mm]*	Bk [mm]
1 Pod	19	2.3	23.6	5 Pods	19	2.3	108.8
2 Pods	19	2.3	44.9	6 Pods	19	2.3	130.1
3 Pods	19	2.3	66.2	7 Pods	19	2.3	151.4
4 Pods	19	2.3	87.5	8 Pods	19	2.3	172.7

* Dimensions when flat without cables/hoses (closed)

Connection clamps - aluminum

The aluminum clamps can be connected **from above or below**.

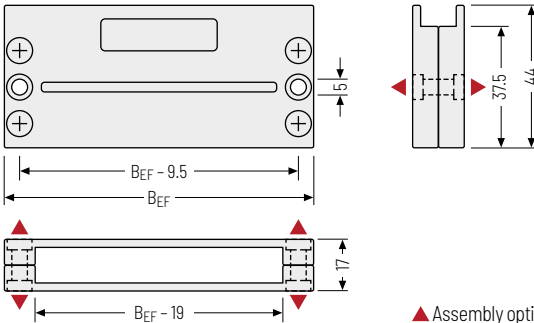

Clamp type	BEF [mm]
For 2 Pods	57.2
For 3 Pods	76.3
For 4 Pods	95.4
For 5 Pods	114.5
For 6 Pods	133.6
For 7 Pods	152.7
For 8 Pods	171.8

▲ Assembly options

MT
seriesXL
seriesROBOTRAX®
System

FLATVEYOR®

CLEANVEYOR®

LS/LSX
seriesS/SX
seriesS/SX-Tubes
series

Accessories

TRAXLINE®

STEEL-LINE

Steel cable carriers for extreme applications

Special applications require the use of special cable carriers. Our steel and stainless steel cable carriers are ideal for extreme heat or other very rough ambient conditions, such as in mining, smelting or oil production. Standardized separating options offer best possible protection for cables and hoses even under strong mechanical strain.

- » Robust design for strong mechanical strain
- » High additional loads and extensive unsupported lengths possible
- » Ideal for extreme and rough ambient conditions
- » Heat-resistant

MT
seriesXLT
seriesROBOTRAX®
System

FLATVEYOR®

CLEANVEYOR®

LS/LSX
seriesS/SX
seriesS/SX-Tubes
series

Accessories

TRAXLINE®



LS/LSX series page 696

Cost-effective steel cable carriers
with lightweight design



S/SX series page 718

Extremely robust and
stable steel cable carriers

LS/LSX series

Cost-effective steel chains
with light design

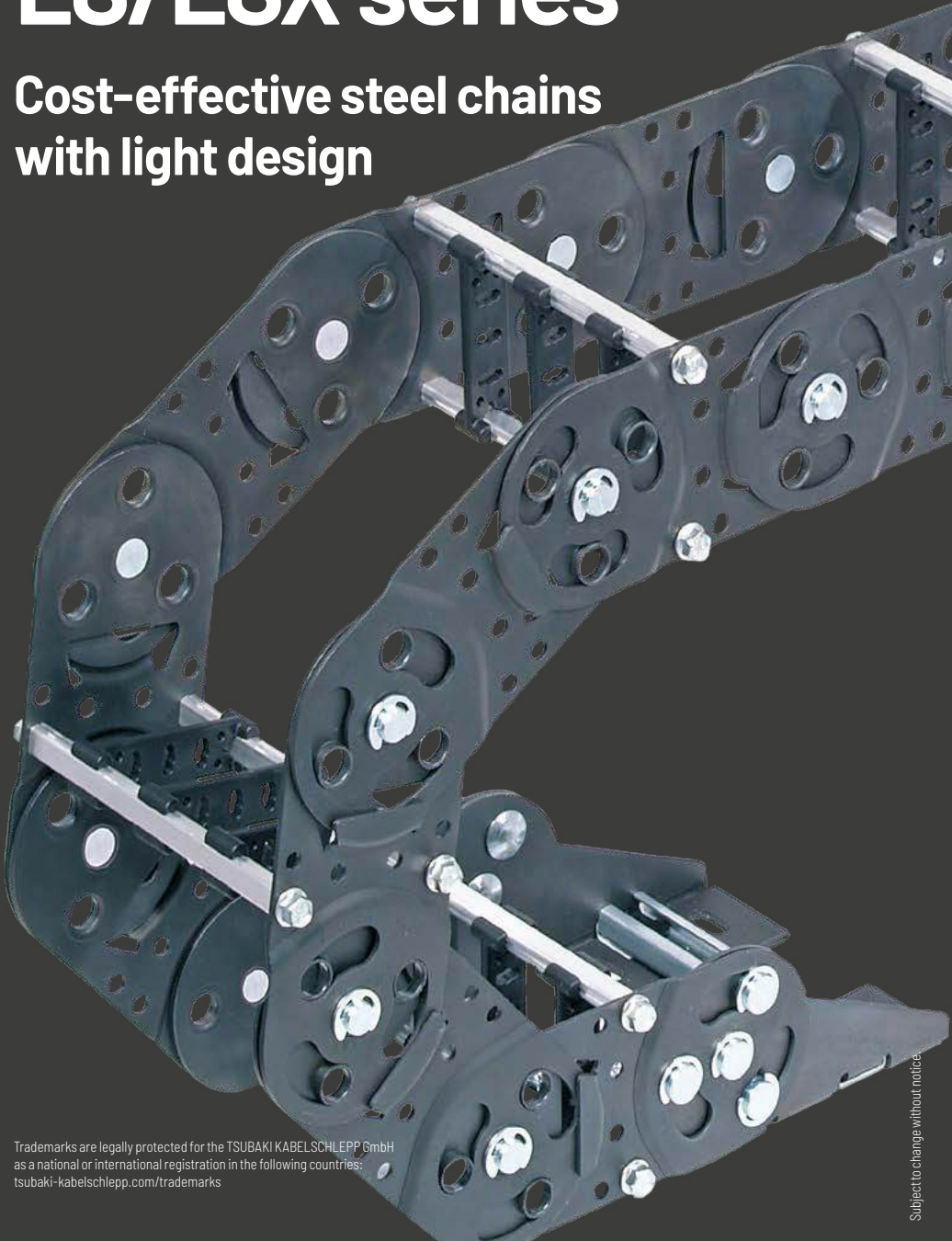

Trademarks are legally protected for the TSUBAKI KABELSCHLEPP GmbH as a national or international registration in the following countries:
tsubaki-kabelschlepp.com/trademarks

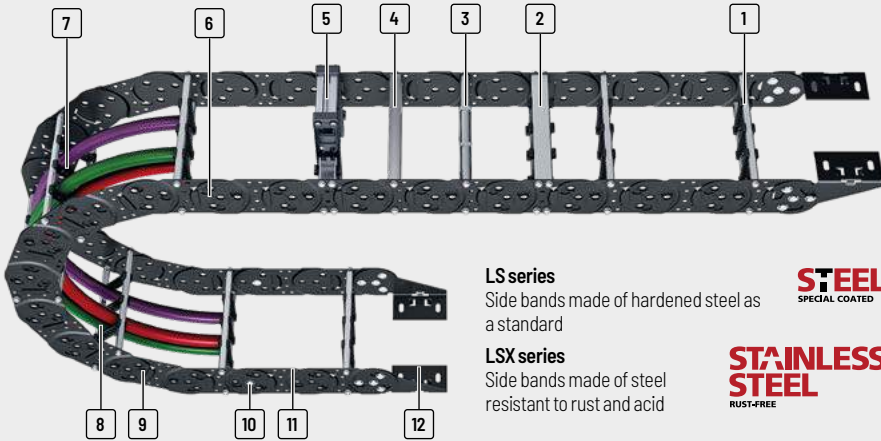
**LS series**

Side bands made of hardened steel as a standard

STEEL
SPECIAL COATED

LSX series

Side bands made of steel resistant to rust and acid

STAINLESS STEEL
RUST-FREE

- 1 All stays available in **1 mm width sections**
- 2 4-fold bolted aluminum stays for extreme loads
- 3 Rolling stays
- 4 Aluminum hole stays
- 5 Mounting frame stays
- 6 Stops integrated into link plate - no additional bolts required
- 7 Different separation options for the cables
- 8 Plastic or steel dividers
- 9 Weight-optimized side bands made of hardened steel or stainless steel
- 10 Optional center bolt for applications with high loads
- 11 Good ratio of inner to outer width - no end divider required
- 12 End connectors for different connection variants

Features

- » Weight-optimized one-part link plate design
- » Better value than comparable steel cable carriers
- » Significantly higher unsupported lengths compared to plastic cable carriers of a similar size
- » Integrated radius and pre-tension stops - in a good value design
- » Bolted stay systems, solid end connectors
- » Cover with steel band available on request
- » Also possible as a double band solution
- » Good corrosion resistance

The design

The weight-optimized link plate design makes the cable carriers very light yet highly sturdy. For the LS series, the unsupported length is significantly higher compared to plastic cable carriers of a similar size.



Weight-optimized link plates consist of only one plate - the stop system is integrated



Lightweight side bands with out additional bolts - hardened steel or stainless steel



Optional: Center bolts and circlip for applications with high loads



Optional: C-rail for strain relief elements attached in the connection

Type	Opening variant	Stay variant	h_i [mm]	h_G [mm]	B_i [mm]	B_k [mm]	B_i - grid [mm]	t [mm]	KR [mm]	Additional load ≤ [kg/m]	Cable- d _{max} [mm]
MT series											
LS/LSX1050											
XLT series		RS2	58	80	84 - 384	100 - 400	1	105	105 - 430	35	46
		RV	58	80	84 - 584	100 - 600	1	105	105 - 430	35	46
ROBOTRAX® System		RR	54	80	84 - 484	100 - 500	1	105	105 - 430	35	43
		LG	48	80	54 - 554	100 - 600	1	105	105 - 430	35	38
FLATVEYOR®		RMA	58 (200)	80 (226)	184 - 384	200 - 400	1	105	105 - 430	35	-

Sturdy and durable, even under extreme conditions

Double-band steel cable carrier LS1050

- » Up to 40% longer unsupported lengths compared to LS1050 with standard side band with the same additional load, as part of the load diagram
- » Very high additional loads: up to 40 kg/m possible
- » Long service life even with high dynamic loads
- » High travel speeds



Longer service life through hardened side bands

The hardened surface significantly increases the service life of the LS1050. Tests were carried out on cable carriers with identical designs.

The LS1050 is therefore ideal for applications with many travel cycles, for example in 3-shift operation.

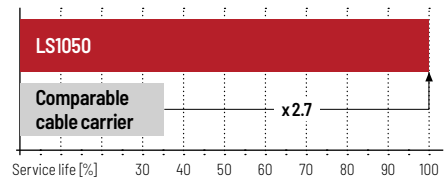

MT series

XLT series

ROBOTRAX® System

FLATVEYOR®

CLEANVEYOR®

LS/LSX series

S/SX series

S/SX-Tubes series

Accessories

TRAXLINE®

Unsupported arrangement			Gliding arrangement			Inner Distribution				Movement			Page
Travel length \leq [m]	$v_{max} \leq$ [m/s]	$a_{max} \leq$ [m/s ²]	Travel length \leq [m]	$v_{max} \leq$ [m/s]	$a_{max} \leq$ [m/s ²]	TS0	TS1	TS2	TS3	vertical hanging or standing	lying on the side	rotating arrangement	
9.5	5	10	-	-	-	•	•	•	•	•	-	-	674
9.5	5	10	-	-	-	•	•	•	•	•	-	-	678
9.5	5	10	-	-	-	•	•	-	-	•	-	-	682
9.5	5	10	-	-	-	-	-	-	-	•	-	-	684
9.5	5	10	-	-	-	•	-	-	-	•	-	-	686

Significantly higher unsupported lengths compared to plastic cable carriers of a similar size

Load diagram for unsupported length depending on the additional load

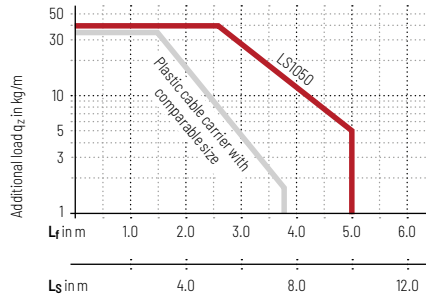
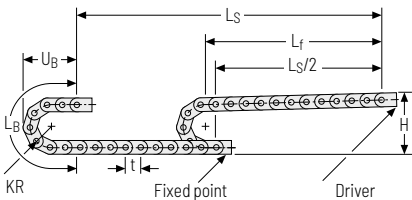

Weight-optimized through adapted link plate design

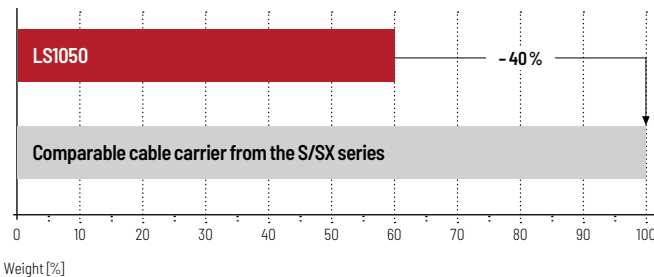

Subject to change without notice.

MT series

XLT series

ROBOTRAX® System

FLATVEYOR®

CLEANVEYOR®

LS/LSX series

S/SX series

S/SX-Tubes series

Accessories

TRAXLINE®

LS/LSX1050



Pitch
105 mm



Inner height
48 - 58 mm



Chain widths
100 - 600 mm



Bending radii
105 - 430 mm

Stay variants



Aluminum stay RS 2 page 674

Frame stay narrow, bolted

- » Quick to open and close.
- » Aluminum profile bars for light to medium loads. Easy threaded connection.
- » **Inside/outside:** Threaded joint easy to release.



Aluminum stay RV page 678

Frame stay, reinforced

- » Aluminum profile bars for medium to heavy loads and large cable carrier widths. Double threaded joint on both sides.
- » **Inside/outside:** Threaded joint easy to release.



Tube stay RR page 682

Frame stay, tube version

- » Steel rolling stays with gentle cable support and steel dividers. Ideal for using media hoses with soft sheathing.
- » **Inside/outside:** Screw connection detachable.



Aluminum stay LG page 684

Frame stay, split

- » Optimum cable routing in the neutral bending line. Split version for easy cable routing. Stays also available unsplit.
- » **Inside/outside:** Threaded joint easy to release.



Aluminum stay RMA page 686

Mounting frame stay

- » Aluminum profile bars with plastic mounting frame stays for guiding very large cable diameters.
- » **Outside/inside:** Screw-fixing easy to release.

Unsupported arrangement

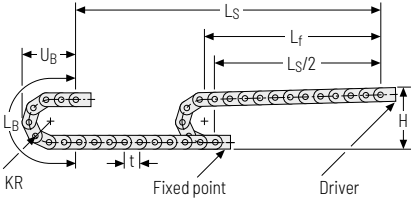

KR [mm]	H [mm]	L _B [mm]	U _B [mm]
105	330	540	250
125	370	603	270
155	430	697	300
195	510	823	340
260	640	1027	405
295	710	1137	440
325	770	1231	470
365	850	1357	510
430	980	1561	575

Installation height H_z

$H_z = H + 10 \text{ mm/m}$

Load diagram for unsupported length depending on the additional load.

Intrinsic cable carrier weight $q_k = 3.8 \text{ kg/m}$. For other inner widths, the maximum additional load changes.

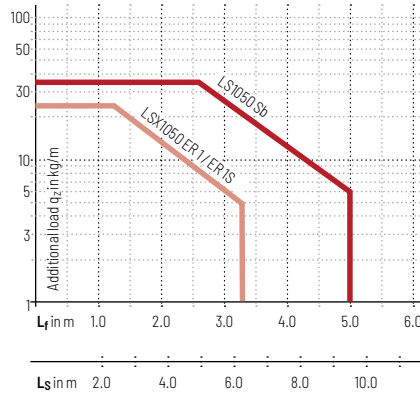

Speed
up to 5 m/s

Acceleration
up to 10 m/s²

Travel length
up to 9.5 m

Additional load
up to 35 kg/m



Information on selecting center bolts and stay arrangement

- » Cable carrier length < 4 m: half-stayed arrangement as a standard
- » Cable carrier length > 4 m: fully-stayed arrangement required
- » Stay width B_{St} > 400 mm: fully-stayed arrangement required
- » Travel speed > 2.5 m/s: fully-stayed arrangement required
- » Use of support rollers: Center bolt **and** fully-stayed arrangement required

MT series
XLT series
ROBOTRAX® System
FLATVEYOR®
CLEANVEYOR®
LS/LSX series
S/SX series
S/SX-Tubes series
Accessories
TRAXLINE®

Aluminum stay RS 2 – frame stay narrow, threaded joint

- » Quick to open and close
- » Aluminum profile bars for light to medium loads.
Simple threaded joint.
- » Available customized in **1 mm grid**.
- » **Inside/outside:** Threaded joint easy to release.

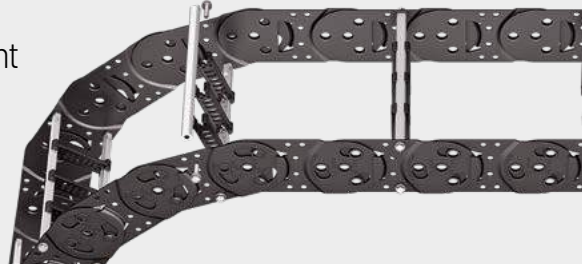

Stay arrangement on every
2nd chain link, **standard**
(**HS: half-stayed**)



Stay arrangement on each
chain link (**VS: fully-stayed**)



1 mm B_k 100 – 400 mm
in **1 mm** width sections

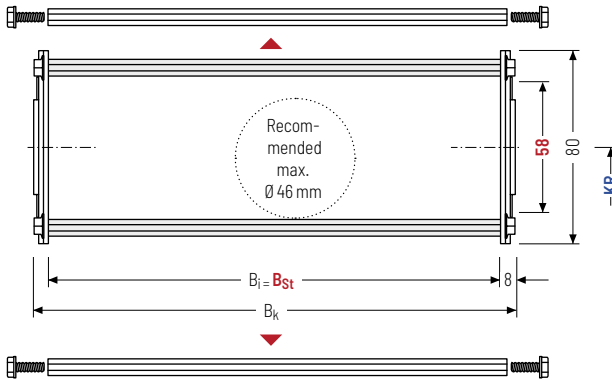

The maximum cable diameter strongly depends on the bending radius and the desired cable type. Please contact us.

Calculating the cable carrier length

Cable carrier length L_k

$$L_k \approx \frac{L_S}{2} + L_B$$

Cable carrier length L_k
rounded to pitch t

h _i [mm]	h _G [mm]	B _i [mm]	B _{St} [mm]*	B _k [mm]	KR [mm]					q _k [kg/m]
58	80	84 384	84 384	B _{St} + 16	105	125	155	195	260	3,63
					295	325	365	430		4,11

* in 1 mm width sections

Order example



LS1050

Type

180

B_{St} [mm]

RS 2

Stay variant

125

KR [mm]

Sb

Material

2415

L_k [mm]

HS

Stay arrangement

Divider systems

As a standard, the divider system is mounted on each crossbar – for stay mounting on every 2nd chain link (HS).

For applications with lateral acceleration and rotated by 90°, the dividers can be attached by simply clipping on a socket (available as an accessory).

As a standard, dividers and the complete divider system (dividers with height separations) can be moved in the cross section (**version A**).

The socket additionally serves as a spacer between the dividers and is available in 1 mm sections between 3 – 50 mm as well as 16.5 and 21.5 mm (**version B**).

Divider system TS0 without height separation

Vers.	a _T min [mm]	a _x min [mm]	a _c min [mm]	π _T min
A	7	14	10	-

The dividers can be moved in the cross section.

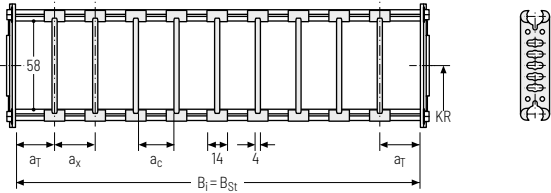

Divider system TS1 with continuous height separation

Vers.	a _T min [mm]	a _T max [mm]	a _x min [mm]	a _c min [mm]	π _T min
A	7	25	14	10	2

The dividers can be moved in the cross section.

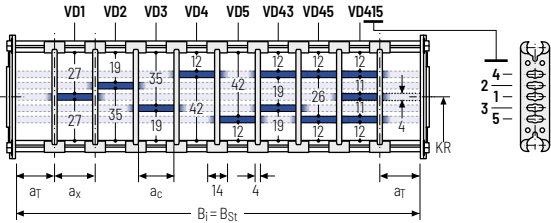

Divider system TS2 with partial height separation

Vers.	a _T min [mm]	a _x min [mm]	a _c min [mm]	π _T min
A	7	23	19	2

With grid distribution (1mm grid). The dividers are attached by the height separation, the grid can be moved in the cross section.

Sliding dividers are optionally available (thickness of divider = 4 mm).

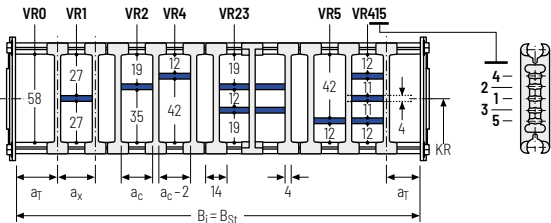

Please note that the real dimensions may deviate slightly from the values indicated here.

Order example

TS2 · A · 3 · K1 · 34 · VR1

⋮ ⋮ ⋮

K4 · 38 · VR3

Divider system Version π_T Chamber a_x Height separation

MT series
XLT series
ROBOTRAX® System
FLATVEVOR®
CLEANVEVOR®
LS/LSX series
S/SX series
S/SX-Tubes series
Accessories
TRAXLINE®

Divider system TS3 with height separation consisting of plastic partitions

As a standard, the divider **version A** is used for vertical partitioning within the cable carrier. The complete divider system can be moved within the cross section.

MT series

XLT series

ROBOTRAX® System

FLATVEYOR®

CLEANVEYOR®

LS/LSX series

S/SX series

S/SX-Tubes series

Accessories

TRAXLINE®

Divider version A

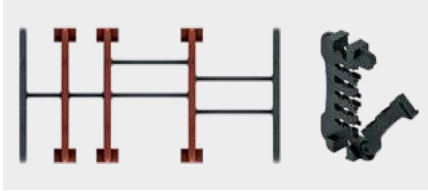

End divider

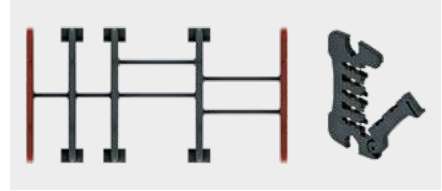

Vers.	a_T min [mm]	a_x min [mm]	a_c min [mm]	n_T min
A	6 / 2*	14	10	2

* For End divider

The dividers are fixed by the partitions, the complete divider system is movable in the cross section.

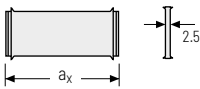
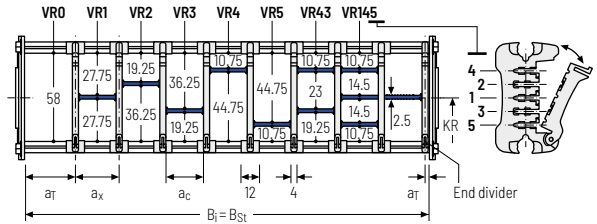

a_x (center distance of dividers) [mm]																
a_c (nominal width of inner chamber) [mm]																
14	16	19	23	24	28	29	32	33	34	38	39	43	44	48	49	54
10	12	15	19	20	24	25	28	29	30	34	35	39	40	44	45	50
58	59	64	68	69	74	78	79	80	84	88	89	94	96	99	112	
54	55	60	64	65	70	74	75	76	80	84	85	90	92	95	108	

When using **partitions with $a_x > 49$ mm** we recommend an additional preferential central support.

Order example



TS3	A	3	K1	34	VR1
			:	:	:
			K4	38	VR3

Divider system Version n_T Chamber a_x Height separation

Please state the designation of the divider system (TS0, TS1,...), version and number of dividers per cross section [n_T]. In addition, please also enter the chambers [K] from left to right, as well as the assembly distances [a_T/a_x] (as seen from the driver).

If using divider systems with height separation (TS1, TS3) please also state the positions [e.g. VD23] viewed from the left driver belt. You are welcome to add a sketch to your order.



Subject to change without notice

TRAXLINE®

Accessories

S/SX-Tubes
series

S/SX
series

LS/LSX
series

CLEANVEYOR®

FLATVEYOR®

ROBOTRAX®
System

XLT
series

MT
series

Aluminum stay RV – frame stay reinforced

- » Aluminum profile bars for medium to heavy loads and large cable carrier widths. Double threaded joint on both sides.
- » Available customized in **1 mm grid**.
- » **Inside/outside:** Threaded joint easy to release.



Stay arrangement on every 2nd chain link, **standard** (HS: half-stayed)



Stay arrangement on each chain link (**VS: fully-stayed**)



1mm B_k 100 – 600 mm
in **1 mm** width sections

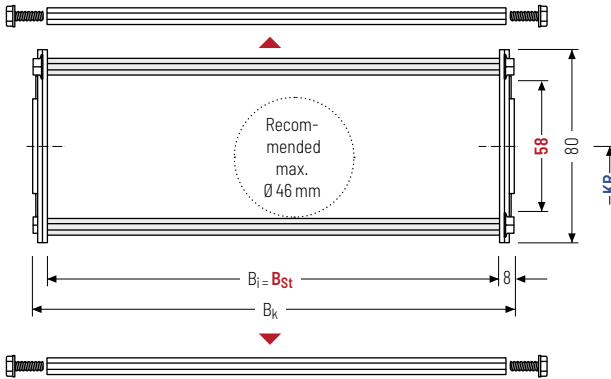

The maximum cable diameter strongly depends on the bending radius and the desired cable type. Please contact us.

Calculating the cable carrier length

Cable carrier length L_k

$$L_k \approx \frac{L_S}{2} + L_B$$

Cable carrier length L_k
rounded to pitch t

h _i [mm]	h _G [mm]	B _i [mm]	B _{St} [mm]*	B _k [mm]	KR [mm]					q _k [kg/m]
58	80	84	84 584	B _{St} + 16	105	125	155	195	260	4.00
		295			325	365	430	5.95		

* in 1 mm width sections

Order example



LS1050

Type

180

B_{St} [mm]

RV

Stay variant

125

KR [mm]

Sb

Material

2415

L_k [mm]

HS

Stay arrangement

Divider systems

As a standard, the divider system is mounted on each crossbar – for stay mounting on every 2nd chain link (HS).

As a standard, dividers and the complete divider system (dividers with height separations) can be moved in the cross section (**version A**).

Divider system TSO without height separation

Vers.	a _T min [mm]	a _x min [mm]	a _c min [mm]	π _T min
A	7	14	10	-

The dividers can be moved in the cross section.

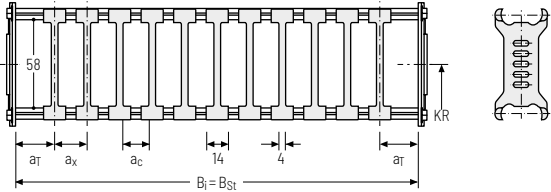

Divider system TS1 with continuous height separation

Vers.	a _T min [mm]	a _T max [mm]	a _x min [mm]	a _c min [mm]	π _T min
A	7	25	14	10	2

The dividers can be moved in the cross section.

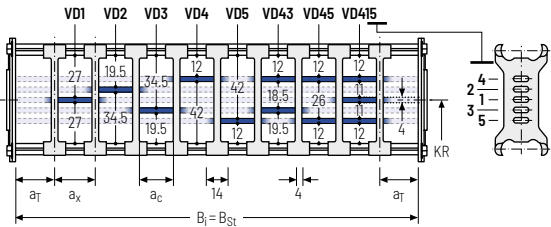

Divider system TS2 with partial height separation

Vers.	a _T min [mm]	a _x min [mm]	a _c min [mm]	π _T min
A	8	21	15	2

With grid distribution (1 mm grid). The dividers are attached by the height separation, the grid can be moved in the cross section.

Sliding dividers are optionally available (thickness of divider = 4 mm).

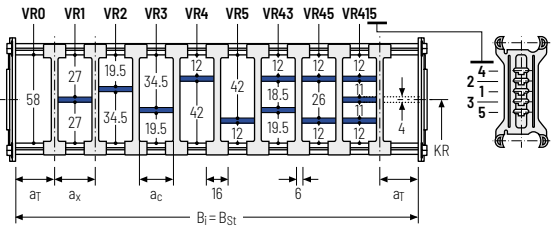

Subject to change without notice.



TRAXLINE® cables for cable carriers

Hi-flex electric cables which were especially developed, optimized and tested for use in cable carriers can be found at tsubaki-kabelschlepp.com/traxline

	MT series
	XLT series
	ROBOTRAX® System
	FLATVEVOR®
	CLEANVEVOR®
	LS/LSX series
	S/SX series
	S/SX-Tubes series
	Accessories
	TRAXLINE®

Divider system TS3 with height separation made of plastic partitions

Vers.	a_T min [mm]	a_x min [mm]	a_c min [mm]	n_T min
A	4	16 / 42*	8	2

* For aluminum partitions

The dividers are fixed by the partitions, the complete divider system is movable in the cross section.

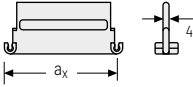
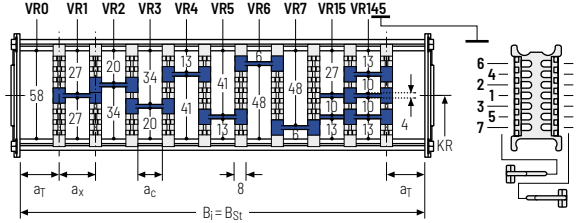

Aluminum partitions in 1 mm increments with $a_x > 42$ mm are also available.

a_x (center distance of dividers) [mm]											
a_c (nominal width of inner chamber) [mm]											
16	18	23	28	32	33	38	43	48	58	64	68
8	10	15	20	24	25	30	35	40	50	56	60
78	80	88	96	112	128	144	160	176	192	208	
70	72	80	88	104	120	136	152	168	184	200	

When using **plastic partitions with $a_x > 112$ mm**, we recommend an additional center support with a **twin divider** ($S_T = 4$ mm). Twin dividers are also suitable for retrofitting in the partition system.

Order example

	TS3	.	A	.	3	.	K1	.	34	-	VR1
							:		:		:
							K4	.	38	-	VR3
	Divider system		Version		n_T		Chamber		a_x		Height separation

Please state the designation of the divider system (**TS0, TS1...**), version and number of dividers per cross section [n_T]. In addition, please also enter the chambers [K] from left to right, as well as the assembly distances [a_T/a_x] (as seen from the driver).

If using divider systems with height separation (**TS1, TS3**) please also state the positions [e.g. VD23] viewed from the left carrier belt. You are welcome to add a sketch to your order.

More product information online



Assembly instructions etc.:
Additional info via your smartphone or check online at
tsubaki-kabelschlepp.com/downloads



Configure your cable carrier here:
online-engineer.de

MT
seriesXLT
seriesROBOTRAX®
System

FLATVEYOR®

CLEANVEYOR®

LS/LSX
seriesS/SX
seriesS/SX-Tubes
series

Accessories

TRAXLINE®



Tube stay RR – frame stay, tube version

- » Steel rolling stays with gentle cable support and steel dividers. Ideal for using media hoses with soft sheathing. Easy screw connection.
- » Available customized in **1 mm width sections**.
- » **Inside/outside: Screw connection detachable**
- » **Option:** Divider systems made from steel and stainless steel ER 1, ER 1S.



Stay arrangement on every 2nd chain link, **standard (HS: half-stayed)**



Stay arrangement on each chain link (**VS: fully-stayed**)



1 mm B_k 100 – 500 mm in **1 mm width sections**

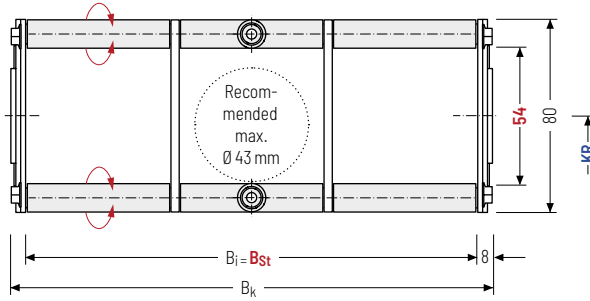

The maximum cable diameter strongly depends on the bending radius and the desired cable type. Please contact us.

Calculating the cable carrier length

Cable carrier length L_k

$$L_k \approx \frac{L_S}{2} + L_B$$

Cable carrier length L_k rounded to pitch t

h _i [mm]	h _G [mm]	B _i [mm]	B _{St} [mm]*	B _k [mm]	KR [mm]					q _k [kg/m]
54	80	84 484	84 484	B _{St} + 16	105	125	155	195	260	4.25
					295	325	365	430		7.80

* in 1 mm width sections



LS1050

Type

180

B_{St} [mm]

RR

Stay variant

125

KR [mm]

Sb

Material

2415

L_k [mm]

HS

Stay arrangement

Divider systems

As a standard, the divider system is mounted on each crossbar – for stay mounting on every 2nd chain link (HS).

The dividers are fixed through the tubes. The tube additionally serves as a spacer between the dividers (**version B**).

Divider system TSO without height separation

Vers.	a _T min [mm]	a _x min [mm]	a _c min [mm]	n _T min
B	20	20	16	-

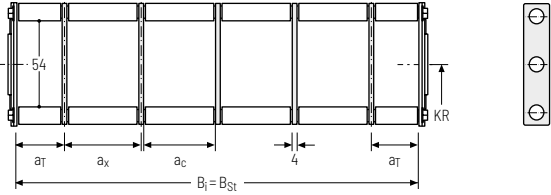

Divider system TS1 with continuous height separation

Vers.	a _T min [mm]	a _T max [mm]	a _x min [mm]	a _c min [mm]	n _T min
B	20	25	20	16	2

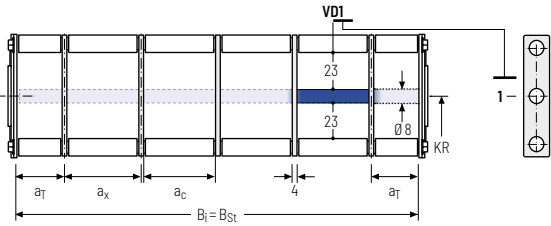

Order example

TS1

B

3

K1

34

V00

⋮
 ⋮
 ⋮

K4

38

V00

Divider system Version n_T Chamber a_x Height separation

Please state the designation of the divider system (**TS0, TS1...**), version and number of dividers per cross section [n_T]. In addition, please also enter the chambers [K] from left to right, as well as the assembly distances [a_T/a_x] (as seen from the driver).

Subject to change without notice.

TRAXLINE® cables for cable carriers
 Hi-flex electric cables which were especially developed, optimized and tested for use in cable carriers can be found at tsubaki-kabelschlepp.com/traxline

MT series
XLT series
ROBOTRAX® System
FLATVEVOR®
CLEANVEVOR®
LS/LSX series
S/SX series
S/SX-Tubes series
Accessories
TRAXLINE®

Aluminum stay LG – hole stay, split version

- » Optimum cable routing in the neutral bending line.
Split version for easy cable routing. Stays also available unsplit.
- » Available customized in **1 mm grid**.
- » **Inside/outside:** Threaded joint easy to release.

HEAVY DUTY
TSUBAKI KABELSCHLEPP



Stay arrangement on every
2nd chain link, **standard**
(HS: half-stayed)



Stay arrangement on each
chain link (VS: fully-stayed)



1mm B_k 100 – 600 mm
in 1 mm width sections

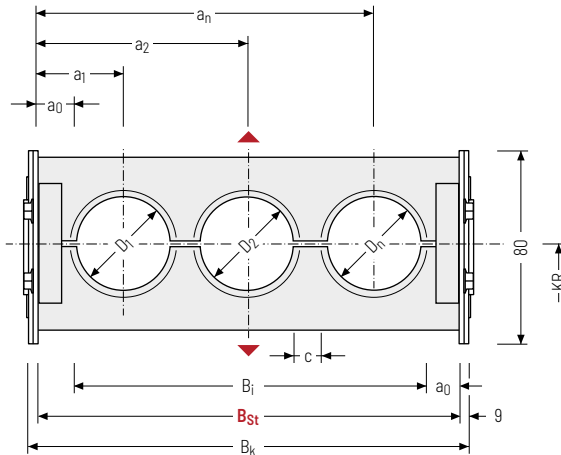

The maximum cable diameter strongly depends on the bending radius and the desired cable type. Please contact us.

Calculating the cable carrier length

Cable carrier length L_k

$$L_k \approx \frac{L_S}{2} + L_B$$

Cable carrier length L_k
rounded to pitch t

Calculating the stay width

Stay width B_{St}

$$B_{St} = \sum D + \sum c + 2 a_0$$

D _{max} [mm]	D _{min} [mm]	h _G [mm]	B _i [mm]	B _{St} [mm]*	B _k [mm]	c _{min} [mm]	a _{0 min} [mm]	KR [mm]					q _k 50 %** [kg/m]
48	12	80	54	82	B _{St} +18	4	14	105	125	155	195	260	4,00
			554	582				295	325	365	430	7,99	

* in 1 mm width sections ** Hole ratio of the hole stay approx. 50 %



LS1050

Type

180

B_{St} [mm]

LG

Stay variant

125

KR [mm]

Sb

Material

2415

L_k [mm]

HS

Stay arrangement



Subject to change without notice.

MT series

XLT series

ROBOTRAX® System

FLATVEYOR®

CLEANVEYOR®

LS/LSX series

S/SX series

S/SX-Tubes series

Accessories

TRAXLINE®

Aluminum stay RMA – mounting frame stay

- » Aluminum profile bars with plastic mounting frame stays for guiding very large cable diameters.
- » The mounting frame stay can be mounted either inside or outside in the bending radius. Available customized in **1 mm width sections**.
- » **Outside/inside:** Screw-fixing easy to release.



Stay arrangement on every 2nd chain link, **standard (HS: half-stayed)**



Stay arrangement on each chain link (**VS: fully-stayed**)



1 mm B_k 200 – 400 mm in **1 mm width sections**

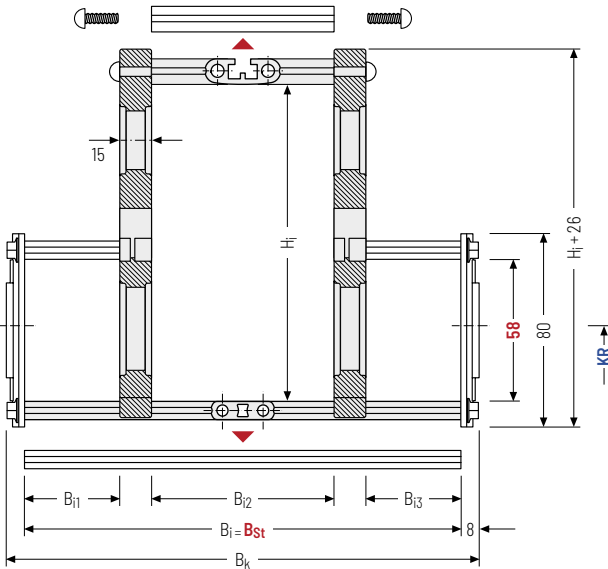

i The maximum cable diameter strongly depends on the bending radius and the desired cable type. Please contact us.

Calculating the cable carrier length

Cable carrier length L_k

$$L_k \approx \frac{L_S}{2} + L_B$$

Cable carrier length L_k rounded to pitch t

i Intrinsic cable carrier weight

Determining the intrinsic cable carrier weight strongly depends on the selected stay arrangement. Please contact us.

h _i [mm]	H _i [mm]	h _G [mm]	B _i [mm]	B _{i1 min} [mm]	B _{i2 min} [mm]	B _{i3 min} [mm]	B _{St} [mm]*	B _k [mm]	KR [mm]	
58	130	80	184 384	35	84	35	184 384	B _{St} + 16	105	
	160								125	
	200								155	
									195	
										260
										325
										365
										430

* in 1 mm width sections

Order example



LS1050
Type

280
B_{St} [mm]

RMA2
Stay variant

195
KR [mm]

Sb
Material

2415
L_k [mm]

HS
Stay arrangement

Assembly variants

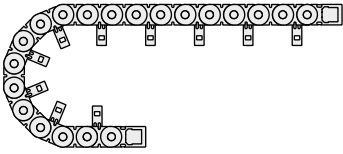

RMA 1 – assembly to the inside:

Gliding application is not possible when using assembly version RMA 1.

Observe minimum KR:

$H_i = 130 \text{ mm}; KR_{\min} = 195 \text{ mm}$

$H_i = 160 \text{ mm}; KR_{\min} = 260 \text{ mm}$

$H_i = 200 \text{ mm}; KR_{\min} = 260 \text{ mm}$

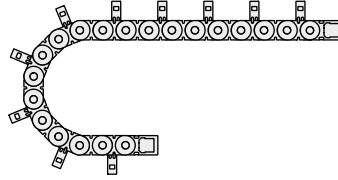

RMA 2 – assembly to the outside:

The cable carrier has to rest on the side bands and not on the stays.

Guiding in a **channel is required** for support. Please contact our technical support at technik@kabelschlepp.de to find the corresponding guiding channel.

Please note the operating and installation height.



Subject to change without notice.

MT series

XLT series

ROBOTRAX® System

FLATVEYOR®

CLEANVEYOR®

LS/LSX series

S/SX series

S/SX-Tubes series

Accessories

TRAXLINE®

MT
seriesXLT
seriesROBOTRAX®
System

FLATVEYOR®

CLEANVEYOR®

LS/LSX
seriesS/SX
seriesS/SX-Tubes
series

Accessories

TRAXLINE®

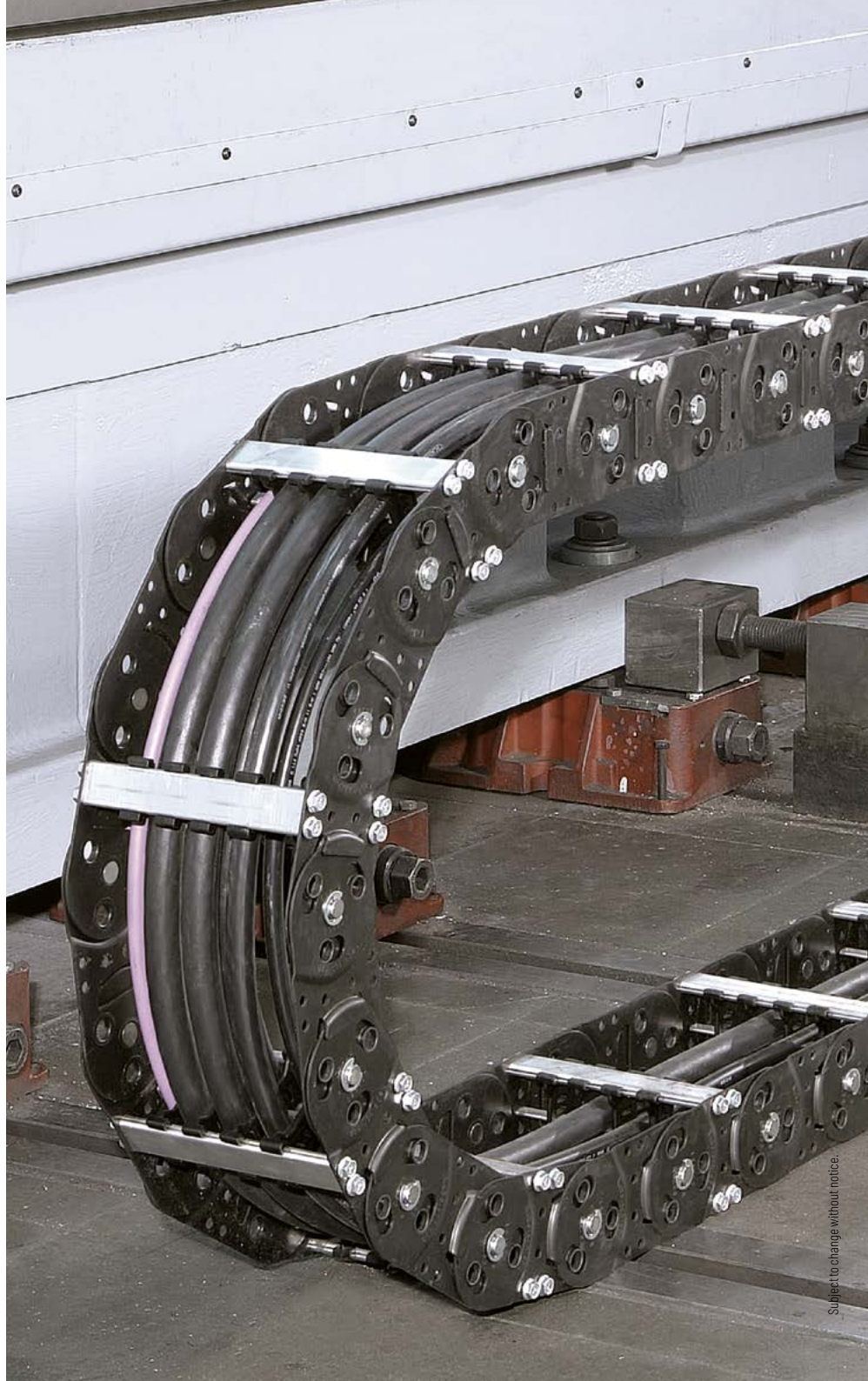

End connectors - steel

End connectors made of steel. The connection variants on the fixed point and on the driver can be combined and, if required, changed afterwards.

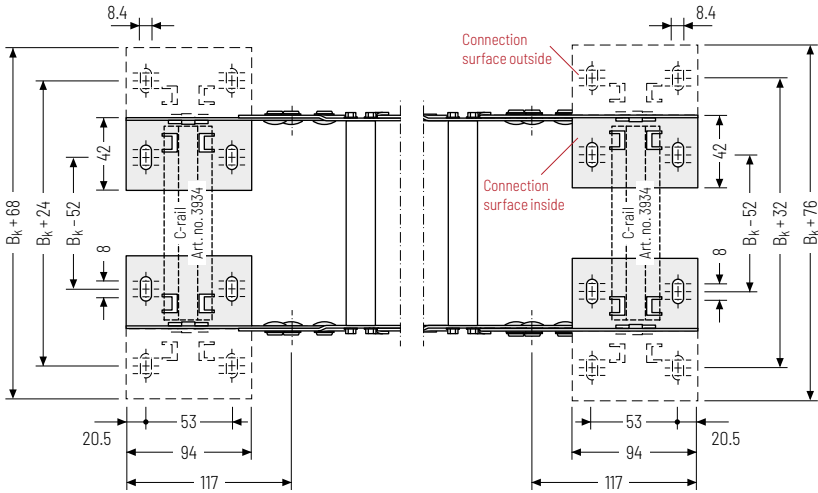
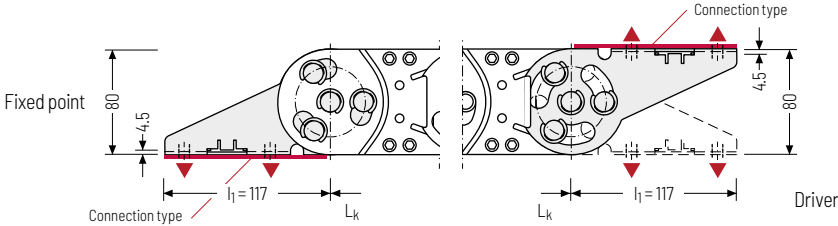

▲ Assembly options

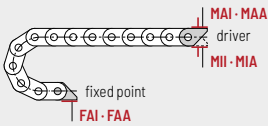

Connection point

- F - fixed point
- M - driver

Connecting surface

- A - connecting surface outside
- I - connecting surface inside

Connection type

- A - threaded joint outside (standard)
- I - threaded joint inside

Order example

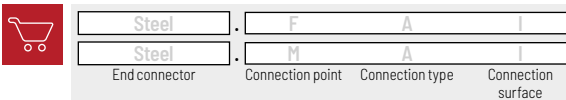

 We recommend the use of strain reliefs before driver and fixed point. See from p. 904.

MT series
XLT series
ROBOTRAX® System
FLATVEYOR®
CLEANVEYOR®
LS/LSX series
S/SX series
S/SX-Tubes series
Accessories
TRAXLINE®

S/SX series

Extremely robust and sturdy steel cable carriers

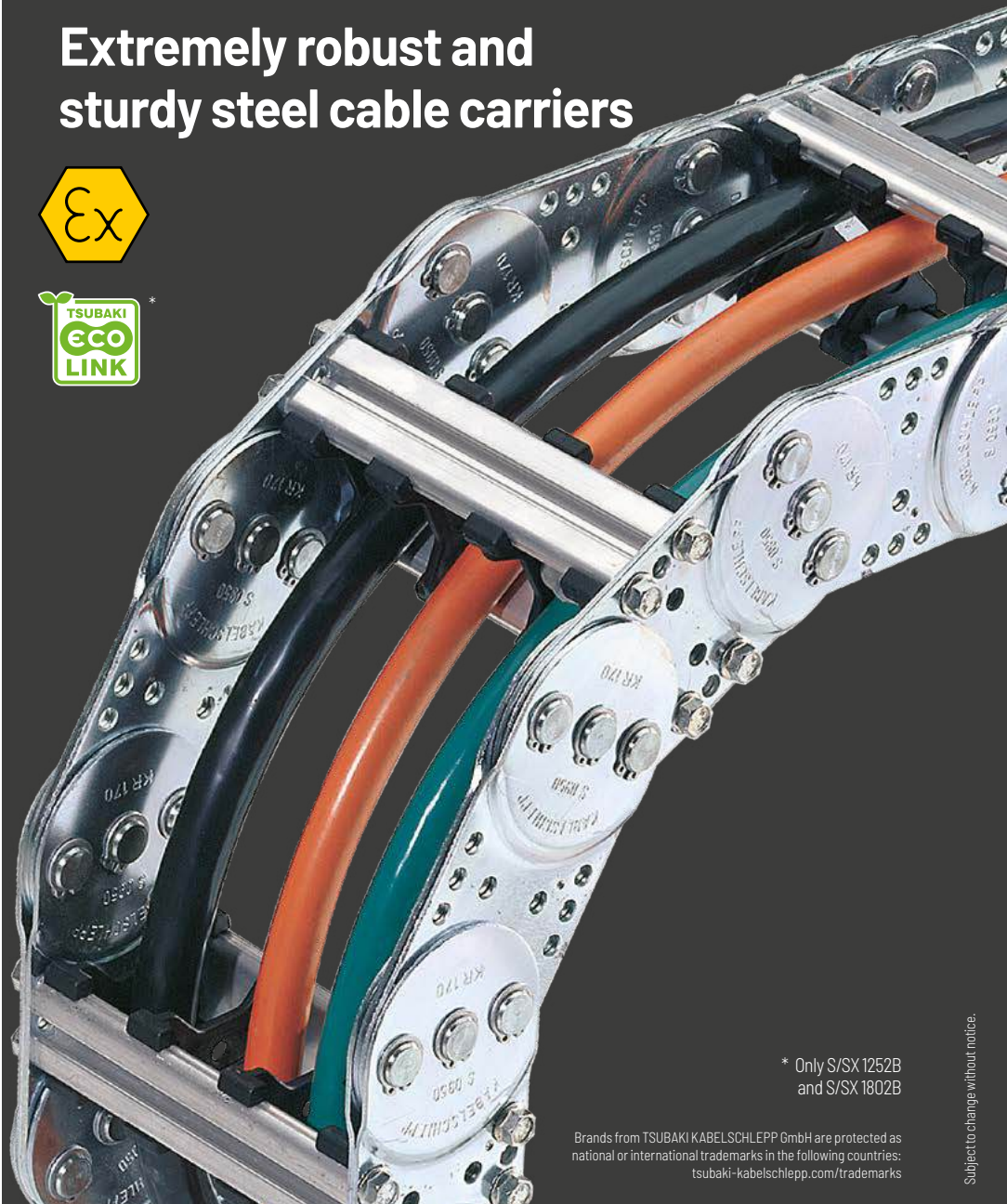

* Only S/SX 1252B
and S/SX 1802B

Brands from TSUBAKI KABELSCHLEPP GmbH are protected as national or international trademarks in the following countries:
tsubaki-kabelschlepp.com/trademarks

Subject to change without notice.

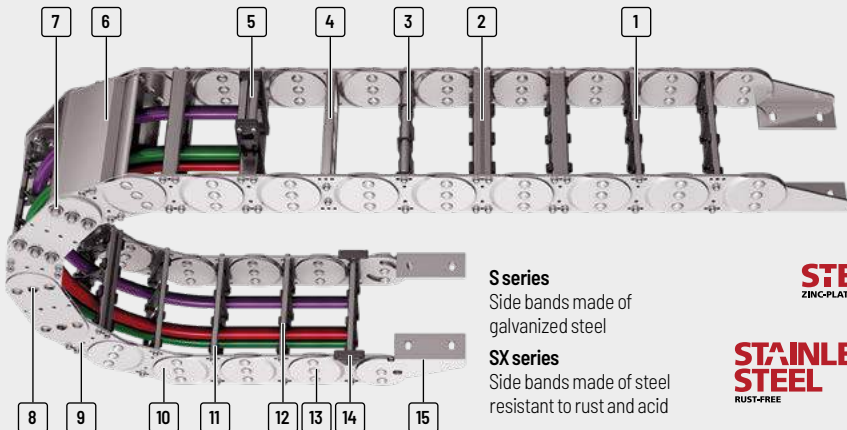

- | | | | |
|---|---|--|---|
| <p>1 All stays available in 1 mm width sections</p> <p>2 Aluminum stays with 4 screw-fixing points for extreme loads</p> <p>3 Roller stays</p> <p>4 Aluminum hole stays</p> <p>5 Mounting frame stays</p> | <p>6 Aluminum cover available in 1 mm width sections</p> <p>7 Joint design with hardened bolts for long service life</p> <p>8 Bolted and riveted joint connections possible</p> | <p>9 Straight link plate design (S/SX1252/1252B and S/SX1802/1802B)</p> <p>10 Cranked link plate design</p> <p>11 Different separation options for the cables</p> | <p>12 Opening inside and outside</p> <p>13 Extremely robust side bands</p> <p>14 Replaceable glide shoes</p> <p>15 End connectors for different connection variants</p> |
|---|---|--|---|

S series
Side bands made of galvanized steel

SX series
Side bands made of steel resistant to rust and acid

STEEL
ZINC-PLATED

STAINLESS STEEL
RUST-FREE

Features

- » Extremely robust, sturdy steel cable carriers for heavy mechanical loads and rough environmental conditions
- » Side bands made of galvanized steel (S series) or corrosion-resistant and acid-resistant steel (SX series) in three qualities: ER 1/ ER 1S and ER 2
- » Very sturdy link plates, each consisting of two individual plates
- » Very extensive unsupported lengths even with large additional loads
- » Bolted stay systems, solid end connectors
- » Joint design with multi stroke system and hardened bolt
- » Explosion protection with classification EX II 2 GD as per ATEX RL

The design

Proven steel cable carriers with extremely sturdy link plates and dedicated joint design with multi stroke system and hardened bolt. The extremely sturdy design allows extensive unsupported lengths and high possible additional loads.

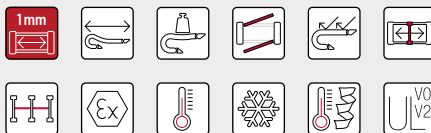

Sandwich design:
Link plates consist of two plates



Glide shoes available for gliding applications



Stroke system with hardened bolt and circlips



Also available as covered variants with cover system or steel band cover, p. 802 and p. 916

Type	Opening variant	Stay variant	h_i [mm]	h_G [mm]	B_i [mm]	B_k [mm]	B_i - grid [mm]	t [mm]	KR [mm]	Additional load ≤ [kg/m]	Cable- d_{max} [mm]
MT series											
XLT series											
ROBOTRAX® System											
FLATVEYOR®											
CLEANVEYOR®											
LS/SX series											
S/SX series											
S/SX-Tubes series											
Accessories											
TRAXLINE®											

S/SX0650											
		RS1	31	50	65 - 265	100 - 300	1	65	75 - 400	30	24
		RS2	31	50	69 - 369	100 - 400	1	65	75 - 400	30	24
		RR	26	50	69 - 369	100 - 400	1	65	75 - 400	30	20
		LG	34	50	35 - 465	70 - 500	1	65	75 - 400	30	26
		RMA	31 (200)	50 (224)	155 - 355	200 - 400	1	65	75 - 400	30	-

S/SX0950											
		RS1	46	68	107 - 257	150 - 300	1	95	125 - 600	45	36
		RS2	46	68	113 - 363	150 - 400	1	95	125 - 600	45	36
		RM	43	68	88 - 563	125 - 600	1	95	125 - 600	45	34
		RR	42	68	115 - 465	150 - 500	1	95	125 - 600	45	33
		LG	50	68	82 - 557	125 - 600	1	95	125 - 600	45	38
		RMR	40	68	108 - 558	150 - 600	1	95	125 - 600	45	32

S/SX1250											
		RS1	72	94	152 - 352	200 - 400	1	125	145 - 1000	50	57
		RS2	72	94	156 - 456	200 - 500	1	125	145 - 1000	50	57
		RV	72	94	154 - 554	200 - 600	1	125	145 - 1000	50	57
		RM	69	94	151 - 751	200 - 800	1	125	145 - 1000	50	55
		RR	66	94	160 - 560	200 - 600	1	125	145 - 1000	50	52
		LG	76	94	82 - 752	130 - 800	1	125	145 - 1000	50	59
		RMA	72 (200)	94 (226)	154 - 554	200 - 600	1	125	145 - 1000	50	-
		RMR	66	94	153 - 753	200 - 800	1	125	145 - 1000	50	52

* More information can be found in our technical manual.

** Depending on the specific application, additional gliding elements or rollers are required.

*** Application-specific, values on request.

S/SX series | Overview

Unsupported arrangement			Gliding arrangement			Inner Distribution				Movement			Page
Travel length ≤ [m]	v_{max} ≤ [m/s]	a_{max} ≤ [m/s ²]	Travel length ≤ [m]	v_{max} ≤ [m/s]	a_{max} ≤ [m/s ²]	TS0	TS1	TS2	TS3	vertical hanging or standing	lying on the side**	rotating arrangement***	
5,8	2,5	5	***	1	2	•	•	***	-	•	•	•	700
5,8	2,5	5	***	1	2	•	•	***	-	•	•	•	702
5,8	2,5	5	***	1	2	•	•	-	-	•	•	•	704
5,8	2,5	5	***	1	2	-	-	-	-	•	•	•	706
5,8	2,5	5	***	1	2	•	-	-	-	•	•	-	*
8,8	2,5	5	***	1	2	•	•	***	-	•	•	•	710
8,8	2,5	5	***	1	2	•	•	***	-	•	•	•	712
8,8	2,5	5	***	1	2	•	•	-	-	•	•	•	714
8,8	2,5	5	***	1	2	•	•	-	-	•	•	•	716
8,8	2,5	5	***	1	2	-	-	-	-	•	•	•	718
8,8	2,5	5	***	1	2	•	-	-	-	•	•	•	*
13,5	2,5	5	***	1	2	•	•	-	•	•	•	•	724
13,5	2,5	5	***	1	2	•	•	-	•	•	•	•	728
13,5	2,5	5	***	1	2	•	•	•	•	•	•	•	732
13,5	2,5	5	***	1	2	•	•	•	-	•	•	•	736
13,5	2,5	5	***	1	2	•	•	-	-	•	•	•	738
13,5	2,5	5	***	1	2	-	-	-	-	•	•	•	740
13,5	2,5	5	***	1	2	•	-	-	-	•	•	-	*
13,5	2,5	5	***	1	2	•	-	-	-	•	•	•	*

Subject to change without notice.

MT series

XLT series

ROBOTRAX® System

FLATVEYOR®

CLEANVEYOR®

LS/LSX series

S/SX series

S/SX-Tubes series

Accessories

TRAXLINE®

Type	Opening variant	Stay variant	h_i [mm]	h_G [mm]	B_i [mm]	B_k [mm]	B_i - grid [mm]	t [mm]	KR [mm]	Additional load ≤ [kg/m]	Cable- d_{max} [mm]
S/SX1800											
XLT series		RM	108	140	188 - 938	250 - 1000	1	180	265 - 1300	60	86
		RR	104	140	201 - 751	250 - 800	1	180	265 - 1300	60	83
		LG	110	140	121 - 941	180 - 1000	1	180	265 - 1300	60	88
S/SX2500											
ROBOTRAX® System		RM	183	220	175 - 1125	250 - 1200	1	250	365 - 1395	100	146
		LG	180	220	174 - 1124	250 - 1200	1	250	365 - 1395	100	144
S/SX3200											
FLATVEYOR®		LG	220	300	181 - 1416	250 - 1500	1	320	470 - 1785	150	176
S/SX3200											
CLEANVEYOR®		LG	220	300	181 - 1416	250 - 1500	1	320	470 - 1785	150	176
S/SX5000											
LS/LSX series		***	150	200	133 - 1083	250 - 1200	1	200	500 - 1200	100	-
S/SX6000											
S/SX series		***	240	300	177 - 1377	300 - 1500	1	320	700 - 1500	150	-
S/SX6000											
S/SX-Tubes series		***	240	300	177 - 1377	300 - 1500	1	320	700 - 1500	150	-

* More information can be found in our technical manual.

** Depending on the specific application, additional gliding elements or rollers are required.

*** Application-specific.

Unsupported arrangement			Gliding arrangement			Inner Distribution				Movement			Page
Travel length ≤ [m]	$v_{max} \leq [m/s]$	$a_{max} \leq [m/s^2]$	Travel length ≤ [m]	$v_{max} \leq [m/s]$	$a_{max} \leq [m/s^2]$	TS0	TS1	TS2	TS3	vertical hanging or standing	lying on the side**	rotating arrangement***	
										•	•	•	746
17,8	2	3	***	0,8	2	•	•	-	•	•	•	•	746
17,8	2	3	***	0,8	2	•	•	-	-	•	•	•	748
17,8	2	3	***	0,8	2	-	-	-	-	•	•	•	750
23,7	1	3	-	-	-	•	•	•	-	•	•	•	754
23,7	1	3	-	-	-	-	-	-	-	•	•	•	758
24	1	2,5	-	-	-	-	-	-	-	•	•	•	762
12	2	3	-	-	-	-	•	-	-	•	•	•	766
16,7	1,5	2	-	-	-	-	•	-	-	•	•	•	767

Subject to change without notice.

MT series

XLT series

ROBOTRAX® System

FLATVEYOR®

CLEANVEYOR®

LS/LSX series

S/SX series

S/SX-Tubes series

Accessories

TRAXLINE®

Type	Opening variant	Stay variant	h_i [mm]	h_G [mm]	B_i [mm]	B_k [mm]	B_i - grid [mm]	t [mm]	KR [mm]	Additional load ≤ [kg/m]	Cable- d_{max} [mm]

S/SX7000



370

450

200 - 1650

350 - 1800

1

450

900 - 2400

600

-

XLT
seriesROBOTRAX®
System

S/SX8000



578

600

200 - 1650

350 - 1800

1

550

900 - 2400

800

-

FLATVEYOR®

S/SX9000



Custom sizes from a cable carrier width of 350 mm

LS/LSX
seriesS/SX
seriesS/SX-Tubes
series

Accessories

TRAXLINE®



S/SX tubes

Also available as covered variants with cover system or steel band cover.
More information can be found in chapter "S/SX tubes" from p. 802.

S/SX series | Overview

Unsupported arrangement			Gliding arrangement			Inner Distribution				Movement			Page
Travel length ≤ [m]	$v_{max} \leq [m/s]$	$a_{max} \leq [m/s^2]$	Travel length ≤ [m]	$v_{max} \leq [m/s]$	$a_{max} \leq [m/s^2]$	TS0	TS1	TS2	TS3	vertical hanging or standing	lying on the side**	rotating arrangement***	

24,9	0,5	0,3	-	-	-	-	•	-	-	•	•	•	768
------	-----	-----	---	---	---	---	---	---	---	---	---	---	-----

24,9	0,5	0,3	-	-	-	-	•	-	-	•	•	•	769
------	-----	-----	---	---	---	---	---	---	---	---	---	---	-----

													772
--	--	--	--	--	--	--	--	--	--	--	--	--	-----

TRAXLINE®	Accessories	S/SX-Tubes series	S/SX series	CLEANVEVOR®	FLATVEVOR®	ROBOTRAX® System	XLT series	MT series
-----------	-------------	-------------------	-------------	-------------	------------	------------------	------------	-----------

Subject to change without notice.

S/SX0650

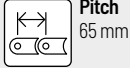

Pitch
65 mm



Inner height
26 - 34 mm



Chain widths
70 - 500 mm



Bending radii
75 - 400 mm

Stay variants



Aluminum stay RS 1 page **700**

Frame stay narrow "The standard"

- » Aluminum profile bars for light to medium loads.
- » **Outside:** release by turning by 90°.
- » **Inside:** Threaded joints easy to release.



Aluminum stay RS 2 page **702**

Frame stay narrow, bolted

- » Aluminum profile bars for light to medium loads. Simple threaded joint.
- » **Outside/inside:** Threaded joints easy to release.



Aluminum stay RR page **704**

Frame stay, tube version

- » Steel rolling stays with gentle cable support and steel dividers. Ideal for using media hoses with soft sheathing.
- » **Inside/outside:** Screw connection detachable.



Aluminum stay LG page **706**

Frame stay, split

- » Optimum cable routing in the neutral bending line. Split version for easy cable routing. Stays also available unsplit.
- » **Inside/outside:** Threaded joint easy to release.

Additional stay variants on request



Aluminum stay RMA

For guiding very large cable diameters



S/SX tubes

Also available as covered variants with cover system or steel band cover. More information can be found in chapter "S/SX tubes" from p. 802.

Unsupported arrangement

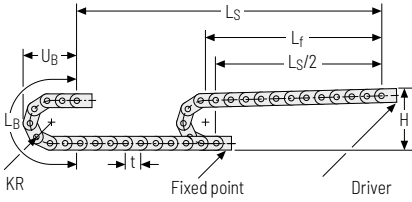

KR [mm]	H [mm]	LB [mm]	UB [mm]
75	225	496	230
95	265	558	250
115	305	621	270
125	325	653	280
135	345	684	290
145	365	716	300
155	385	747	310
175	425	810	330
200	475	888	355
250	575	1045	405
300	675	1202	455
400	875	1516	555





Installation height H_z

$H_z = H + 10 \text{ mm/m}$

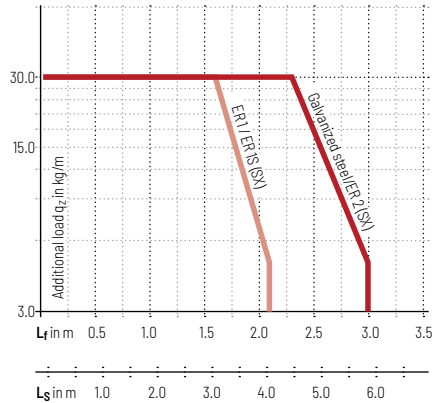
Load diagram for unsupported length depending on the additional load.

Intrinsic cable carrier weight $q_k = 4.5 \text{ kg/m}$. For other inner widths, the maximum additional load changes.



- 
Speed
up to 2.5 m/s
- 
Acceleration
up to 5 m/s²
- 
Travel length
up to 5.8 m
- 
Additional load
up to 30 kg/m

Gliding arrangement

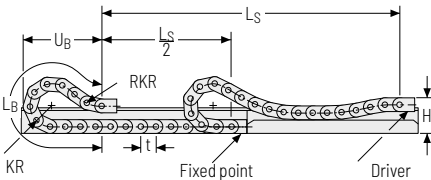

 The gliding cable carrier must be guided in a channel. See p. 844.

Glide shoes have to be used for gliding applications.

- 
Speed
up to 1 m/s
- 
Acceleration
up to 2 m/s²
- 
Travel length
on request
- 
Additional load
up to 30 kg/m

MT series
XLT series
ROBOTRAX® System
FLATVEYOR®
CLEANVEYOR®
LS/LSX series
S/SX series
S/SX-Tubes series
Accessories
TRAXLINE®

Aluminum stay RS1 - frame stay narrow

- » Extremely quick to open and close
- » Aluminum profile bars for light to medium loads.
- » Available customized in **1 mm width sections**.
- » **Outside:** release by rotating 90°.
- » **Inside:** Threaded joint easy to release.



Stay arrangement on every
2nd chain link standard
(HS: half-stayed)



Stay arrangement on each
chain link **(VS: fully-stayed)**



1mm B_k from 100 - 300 mm
in **1 mm width sections**

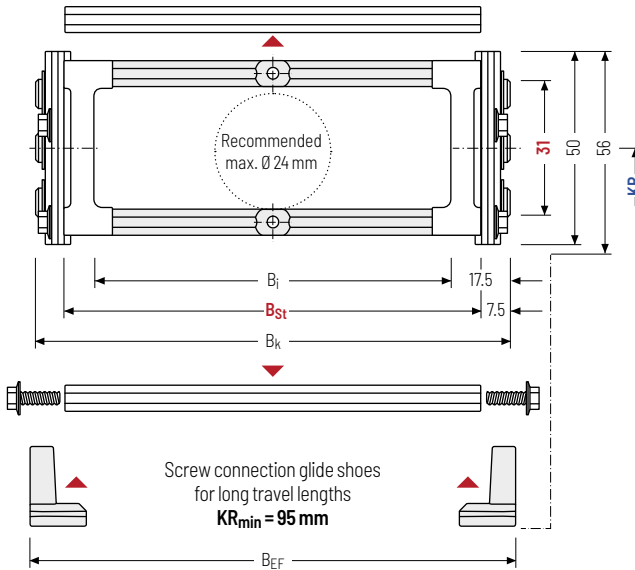

The maximum cable diameter strongly depends on the bending radius and the desired cable type. Please contact us.

Calculating the cable carrier length

Cable carrier length L_k

$$L_k \approx \frac{L_S}{2} + L_B$$

Cable carrier length L_k
rounded to pitch t

h _i [mm]	h _G [mm]	h _{G'} [mm]	B _i [mm]	B _{St} [mm]*	B _k [mm]	B _{EF} [mm]	KR [mm]				q _k [kg/m]		
31	50	56	65 265	85 285	B _{St} + 15	B _{St} + 20	75	95	115	125	135	145	3.95
							155	175	200	250	300	400	4.82

* in 1 mm width sections

Order example



SX0650 · **180** · **RS1** · **135** · **St** · **1430** · **HS**
Type B_{St} [mm] Stay variant KR [mm] Material L_k [mm] Stay arrangement

Divider systems

The divider system is mounted on each crossbar as a standard – on every 2nd chain link for stay mounting (HS).

As a standard, dividers or the complete divider system (dividers with height separations) are movable in the cross section (**version A**).

For applications with lateral acceleration and rotated by 90°, the dividers can be attached by simply clipping onto a socket (available as an accessory).

The socket additionally acts as a spacer between the dividers and is available in 1 mm increments between 3 – 50 mm (**version B**).

Divider system TSO without height separation

Vers.	a _T min [mm]	a _x min [mm]	a _c min [mm]	n _T min
A	11.5	13	10	-

The dividers can be moved in the cross section.

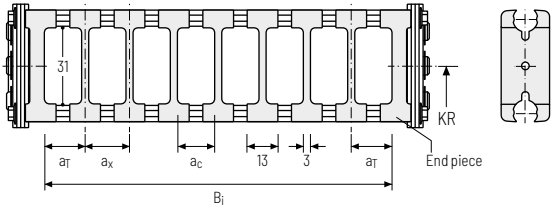

Divider system TS1 with continuous height separation

Vers.	a _T min [mm]	a _x min [mm]	a _c min [mm]	n _T min
A	11.5	13	10	2

The dividers can be moved in the cross section.

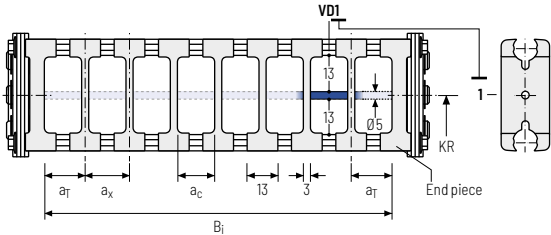

Order example

TS1

A

3

VD0

⋮

VD1

Divider system
Version
n_T
Height separation

Please state the designation of the divider system (**TS0, TS1...**), version and number of dividers per cross section [n_T].

If using divider systems with height separation (**TS1**) please also state the positions [e.g. VD1] viewed from the left driver belt. You are welcome to add a sketch to your order.

The end pieces are part of the divider system and don't have to be ordered separately.

- MT series
- XLT series
- ROBOTRAX® System
- FLATVEVOR®
- CLEANVEVOR®
- LS/LSX series
- S/SX series
- S/SX-Tubes series
- Accessories
- TRAXLINE®

Aluminum stay RS 2 – frame stay narrow, threaded joint

- » Quick to open and close
- » Aluminum profile bars for light to medium loads. Simple threaded joint
- » Available customized in **1 mm width sections**.
- » **Outside/inside:** Threaded joint easy to release.



Stay arrangement on every
2nd chain link standard
(HS: half-stayed)



Stay arrangement on each
chain link **(VS: fully-stayed)**



1mm B_k from 100 – 400 mm
in **1 mm width sections**

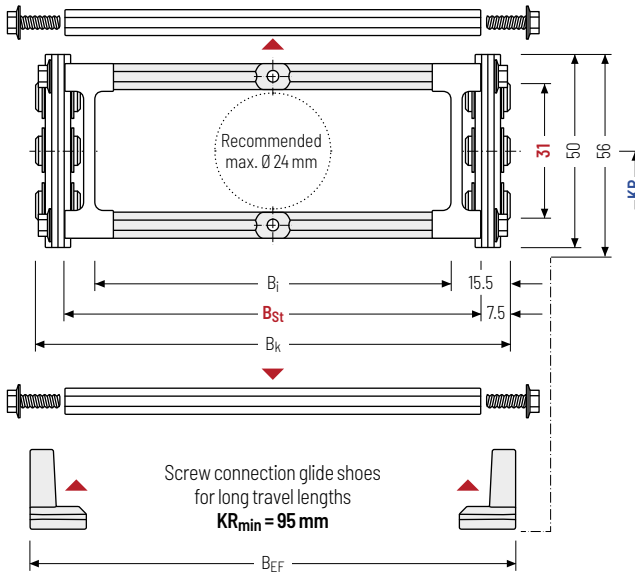

The maximum cable diameter strongly depends on the bending radius and the desired cable type. Please contact us.

Calculating the cable carrier length

Cable carrier length L_k

$$L_k \approx \frac{L_S}{2} + L_B$$

Cable carrier length L_k
rounded to pitch t

h _i [mm]	h _G [mm]	h _{G'} [mm]	B _i [mm]	B _{St} [mm]*	B _k [mm]	B _{EF} [mm]	KR [mm]						q _k [kg/m]
31	50	56	69 369	85 385	B _{St} + 15	B _{St} + 20	75	95	115	125	135	145	3.95
							155	175	200	250	300	400	

* in 1 mm width sections

Order example



S0650

Type

180

B_{St}[mm]

RS 2

Stay variant

135

KR [mm]

St

Material

1430

L_k[mm]

HS

Stay arrangement

Divider systems

The divider system is mounted on each crossbar as a standard – on every 2nd chain link for stay mounting (HS).

As a standard, dividers or the complete divider system (dividers with height separations) are movable in the cross section (**version A**).

For applications with lateral acceleration and rotated by 90°, the dividers can be attached by simply clipping onto a socket (available as an accessory).

The socket additionally acts as a spacer between the dividers and is available in 1 mm increments between 3 – 50 mm (**version B**).

Divider system TSO without height separation

Vers.	a _T min [mm]	a _x min [mm]	a _c min [mm]	n _T min
A	11.5	13	10	-

The dividers can be moved in the cross section.

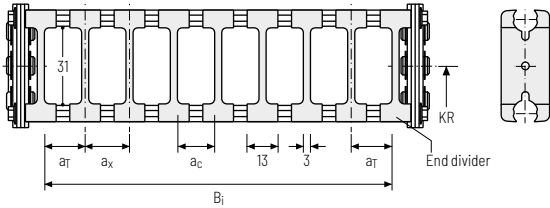

Divider system TS1 with continuous height separation

Vers.	a _T min [mm]	a _x min [mm]	a _c min [mm]	n _T min
A	11.5	13	10	2

The dividers can be moved in the cross section.

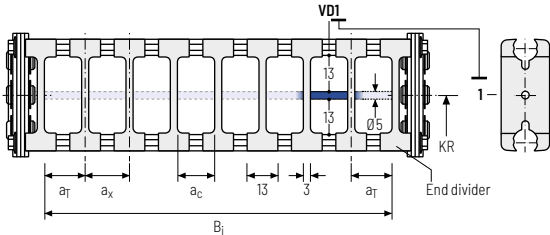

Order example

TS1 ·
 A ·
 3 -
 VD0
 :
 - VD1

Divider system
Version
n_T
Height separation

Please state the designation of the divider system (**TS0, TS1...**), version and number of dividers per cross section [n_T].

If using divider systems with height separation (**TS1**) please also state the positions [e.g. VD1] viewed from the left driver belt. You are welcome to add a sketch to your order.

The end dividers are part of the divider system and don't have to be ordered separately.

	MT series
	XLT series
	ROBOTRAX® System
	FLATVEVOR®
	CLEANVEVOR®
	LS/LSX series
	S/SX series
	S/SX-Tubes series
	Accessories
	TRAXLINE®

Tube stay RR – frame stay, tube version

- » Steel rolling stays with gentle cable support and plastic dividers. Ideal for using media hoses with soft sheathing. Easy screw connection.
- » Available customized in **1 mm width sections**.
- » **Inside/outside:** Screw connection detachable
- » **Option:** Divider systems made from steel and stainless steel ER 1, ER 1S.



Stay arrangement on every 2nd chain link standard
(HS: half-stayed)



Stay arrangement on each chain link **(VS: fully-stayed)**



1 mm B_k from 100 – 400 mm
in **1 mm width sections**

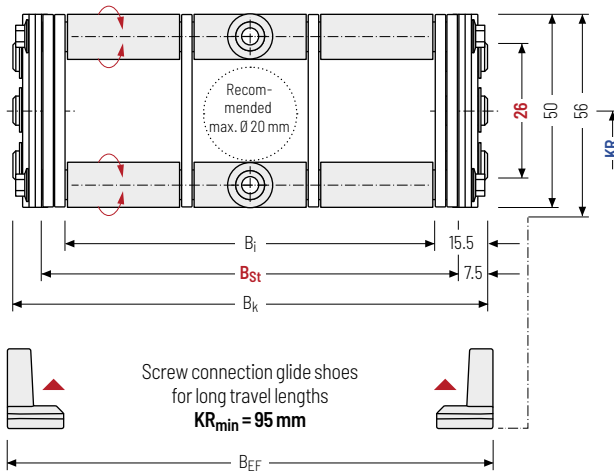

i The maximum cable diameter strongly depends on the bending radius and the desired cable type. Please contact us.

Calculating the cable carrier length

Cable carrier length L_k

$$L_k \approx \frac{L_S}{2} + L_B$$

Cable carrier length L_k
rounded to pitch t

h _i [mm]	h _G [mm]	h _{G'} [mm]	B _i [mm]	B _{St} [mm]*	B _k [mm]	B _{EF} [mm]	KR [mm]						q _k [kg/m]
26	50	56	69	85	B _{St} + 15	B _{St} + 20	75	95	115	125	135	145	4.77
			369	385			155	175	200	250	300	400	8.67

* in 1 mm width sections

Order example



S0650

Type

180

B_{St}[mm]

RR

Stay variant

135

KR [mm]

St

Material

1430

L_k[mm]

HS

Stay arrangement

Divider systems

As a standard, the divider system is mounted on each crossbar – for stay mounting on every 2nd chain link (HS).

The dividers are fixed through the tubes. The tube additionally serves as a spacer between the dividers (**version B**).

Divider system TSO without height separation

Vers.	a _T min [mm]	a _x min [mm]	a _c min [mm]	n _T min
B	20	25	21	-

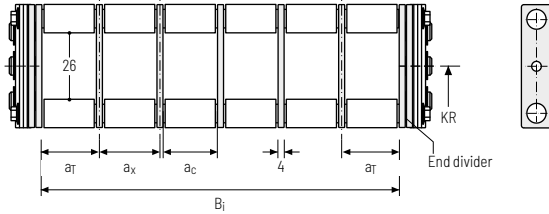

Divider system TS1 with continuous height separation

Vers.	a _T min [mm]	a _x min [mm]	a _c min [mm]	n _T min
B	20	25	21	2

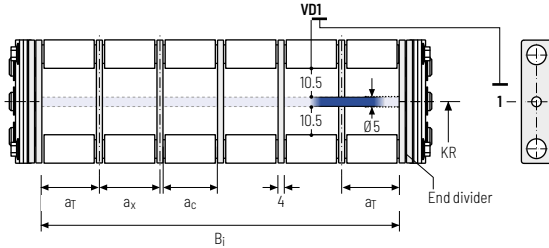

Order example

TS1	·	B	·	3	·	K1	·	34	-	V00	
				⋮			⋮			⋮	
				·	K4		·		38	-	V00
Divider system		Version		n _T		Chamber		a _x		Height separation	

Please state the designation of the divider system (**TS0, TS1...**), version and number of dividers per cross section [n_T]. In addition, please also enter the chambers [K] from left to right, as well as the assembly distances [a_T/a_x] (as seen from the driver).

Subject to change without notice.

TRAXLINE® cables for cable carriers

Hi-flex electric cables which were especially developed, optimized and tested for use in cable carriers can be found at tsubaki-kabelschlepp.com/traxline

	MT series
	XLT series
	ROBOTRAX® System
	FLATVEVOR®
	CLEANVEVOR®
	LS/LSX series
	S/SX series
	S/SX-Tubes series
	Accessories
	TRAXLINE®

Aluminum stay LG - hole stay, split version

- » Optimum cable routing in the neutral bending line.
Split version for easy cable routing. Stays also available unsplit.
- » Available customized in **1 mm grid**.
- » **Inside/outside:** Threaded joint easy to release.

HEAVY DUTY
TSUBAKI KABELSCHLEPP



Stay arrangement on every
2nd chain link standard
(HS: half-stayed)



Stay arrangement on each
chain link **(VS: fully-stayed)**



1mm B_i 70 - 500 mm
in **1 mm width sections**

FLATVEYOR®

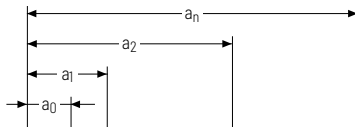

CLEANVEYOR®

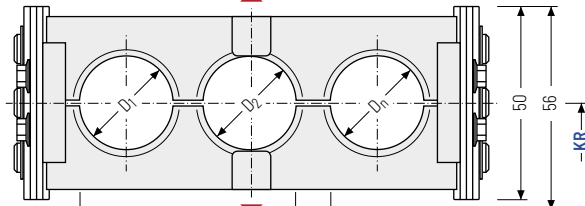

LS/LSX series

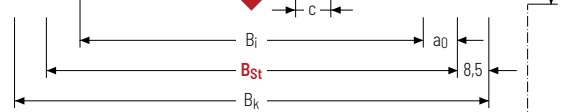

S/SX series



The maximum cable diameter strongly depends on the bending radius and the desired cable type. Please contact us.

Calculating the cable carrier length

Cable carrier length L_k

$$L_k \approx \frac{L_S}{2} + L_B$$

Cable carrier length L_k
rounded to pitch t

Calculating the stay width

Stay width B_{St}

$$B_{St} = \sum D + \sum c + 2 a_0$$

D _{max} [mm]	D _{min} [mm]	h _G [mm]	h _{G'} [mm]	B _i [mm]	B _{St} [mm]*	B _k [mm]	B _{EF} [mm]	c _{min} [mm]	a _{0 min} [mm]	KR [mm]				q _k 50%** [kg/m]
34	10	50	56	35	53	B _{St}	B _{St}	4	9	75	95	115	125	3.96
				-	-	+	+			135	145	155	175	-
				465	483	17	22			200	250	300	400	6.46

* in 1 mm width sections ** Hole ratio of the hole stay approx. 50 %

Order example



S0650

Type

180

 B_{St} [mm]

LG

Stay variant

135

KR [mm]

St

Material

1430

 L_k [mm]

HS

Stay arrangement

End connectors - steel

End connectors made of steel. The connection variants on the fixed point and on the driver can be combined and changed later on, if necessary.

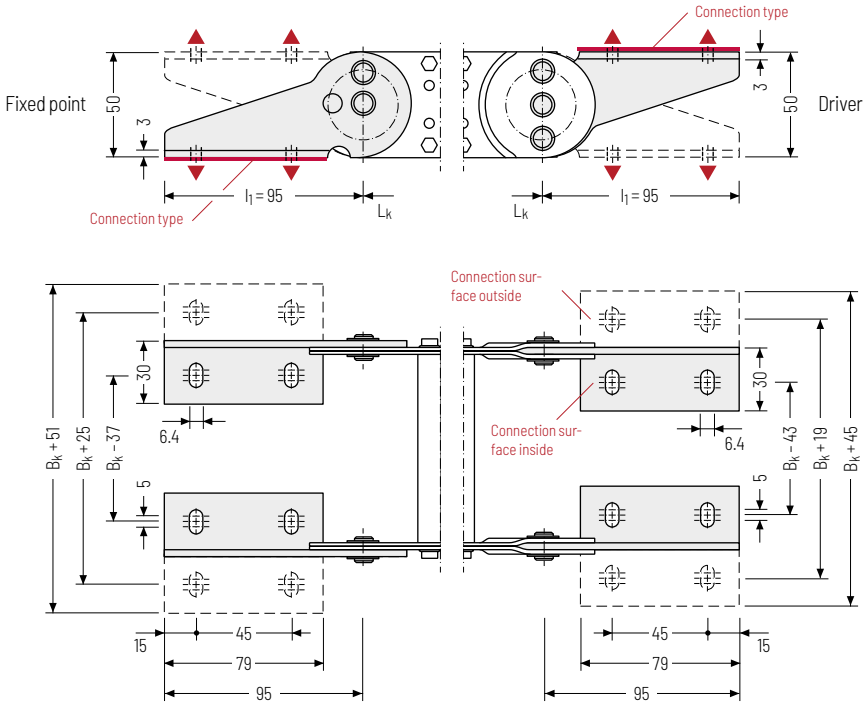

▲ Assembly options

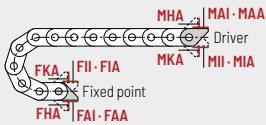

Connection point

- F - fixed point
- M - driver

Connection type

- A - threaded joint to outside (standard)
- I - threaded joint to inside
- H - threaded joint, rotated 90° to the outside
- K - threaded joint, rotated 90° to the inside

Connection surface

- I - connection surface inside (standard)
- A - connection surface outside

Caution: The standard connection variant FAI/MAI is only possible from B_k of 70 mm.

Order example

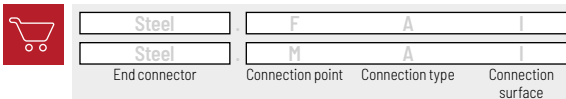

Caution: We recommend the use of strain reliefs at the driver and fixed point. See from p. 904.

MT series
XLT series
ROBOTRAX® System
FLATVEYOR®
CLEANVEYOR®
LS/LSX series
S/SX series
S/SX-Tubes series
Accessories
TRAXLINE®

S/SX0950

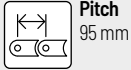

Pitch
95 mm



Inner heights
42 – 50 mm



Chain widths
125 – 600 mm



Bending radii
125 – 600 mm

Stay variants



Aluminum stay RS 1 page 710

Frame stay narrow "The standard"

- » Aluminum profile bars for light to medium loads.
- » **Outside:** release by turning by 90°.
- » **Inside:** Threaded joints easy to release.



Aluminum stay RS 2 page 712

Frame stay narrow, bolted

- » Aluminum profile bars for light to medium loads. Simple threaded joint.
- » **Outside/inside:** Threaded joints easy to release.



Aluminum stay RM page 714

Frame stay, solid

- » Aluminum profile bars for heavy loads and maximum cable carrier widths. Double threaded joint on both sides "**Heavy Duty**".
- » **Inside/outside:** Threaded joints easy to release.



Tube stay RR page 716

Frame stay, tube version

- » Steel rolling stays with gentle cable support and steel dividers. Ideal for using media hoses with soft sheathing.
- » **Inside/outside:** Screw connection detachable.



Aluminum stay LG page 718

Frame stay, split

- » Optimum cable routing in the neutral bending line. Split version for easy cable routing. Stays also available unsplit.
- » **Inside/outside:** Threaded joint easy to release.

Additional stay variants on request

Aluminum stay RMR

Gentle cable guiding with rollers.

S/SX tubes

Also available as covered variants with cover system or steel band cover. More information can be found in chapter "S/SX tubes" from p. 802.

Unsupported arrangement

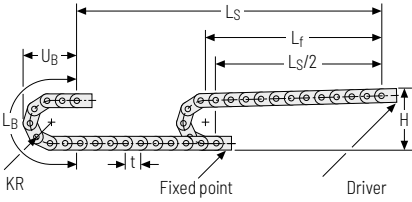

KR [mm]	H [mm]	L _B [mm]	U _B [mm]
125	352	773	350
140	382	820	365
170	442	914	395
200	502	1008	425
260	622	1197	485
290	682	1291	515
320	742	1385	545
350	802	1480	575
410	922	1668	635
600	1302	2264	825

Installation height H_z

$H_z = H + 10 \text{ mm/m}$

Load diagram for unsupported length depending on the additional load.

Intrinsic cable carrier weight $q_k = 7.6 \text{ kg/m}$. For other inner widths, the maximum additional load changes.

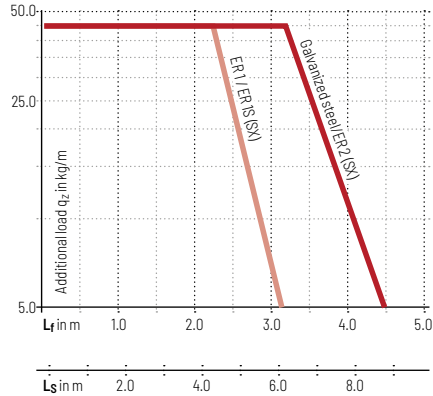

- Speed** up to 2.5 m/s
- Acceleration** up to 5 m/s²
- Travel length** up to 8.8 m
- Additional load** up to 45 kg/m

Gliding arrangement

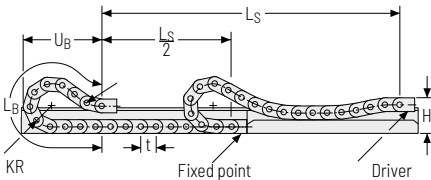

The gliding cable carrier must be guided in a channel. See p. 844.

Glide shoes have to be used for gliding applications.

- Speed** up to 1 m/s
- Acceleration** up to 2 m/s²
- Travel length** on request
- Additional load** up to 45 kg/m

MT series
XLT series
ROBOTRAX® System
FLATVEYOR®
CLEANVEYOR®
LS/LSX series
S/SX series
S/SX-Tubes series
Accessories
TRAXLINE®

Aluminum stay RS1 - frame stay narrow

- » Extremely quick to open and close
- » Aluminum profile bars for light to medium loads.
- » Available customized in **1 mm width sections**.
- » **Outside:** release by rotating 90°.
- » **Inside:** Threaded joint easy to release



Stay arrangement on every
2nd chain link, standard
(HS: half-stayed)



Stay arrangement on each
chain link **(VS: fully-stayed)**



1 mm B_k from 150 - 300 mm
in **1 mm width sections**

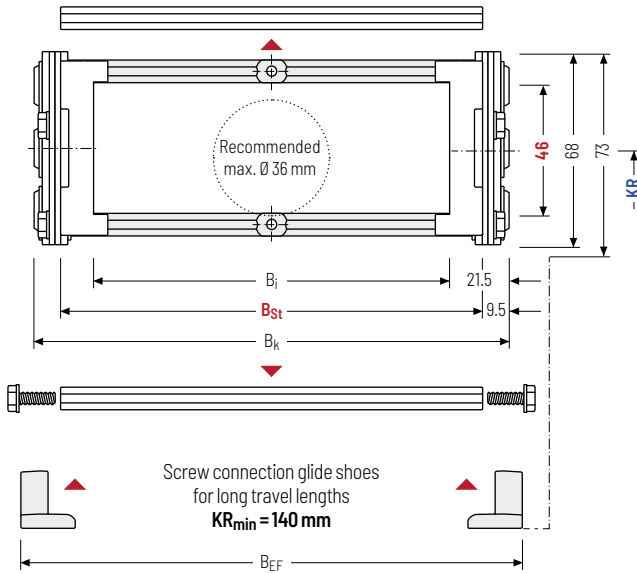

The maximum cable diameter strongly depends on the bending radius and the desired cable type. Please contact us.

Calculating the cable carrier length

Cable carrier length L_k

$$L_k \approx \frac{L_S}{2} + L_B$$

Cable carrier length L_k
rounded to pitch t

h _i [mm]	h _g [mm]	h _{g'} [mm]	B _i [mm]	B _{St} [mm]*	B _k [mm]	B _{EF} [mm]	KR [mm]					q _k [kg/m]
46	68	73	107 257	131 281	B _{St} + 19	B _{St} + 28	125	140	170	200	260	7.55
							290	320	350	400	600	7.95

* in 1 mm width sections

Order example



S0950

Type

150

B_{St} [mm]

RS1

Stay variant

200

KR [mm]

St

Material

2375

L_k [mm]

HS

Stay arrangement

Divider systems

The divider system is mounted on each crossbar as a standard – on every 2nd chain link for stay mounting (HS). As a standard, dividers or the complete divider system (dividers with height separations) are movable in the cross section (**version A**).

For applications with lateral acceleration and rotated by 90°, the dividers can be attached by simply clipping onto a socket (available as an accessory).

This socket additionally acts as a spacer between the dividers and is available in a 1 mm grid between 3 – 50 mm, as well as 16.5 and 21.5 mm (**version B**).

Divider system TSO without height separation

Vers.	a _T min [mm]	a _x min [mm]	a _c min [mm]	n _T min
A	12	14	10	-

The dividers can be moved in the cross section.

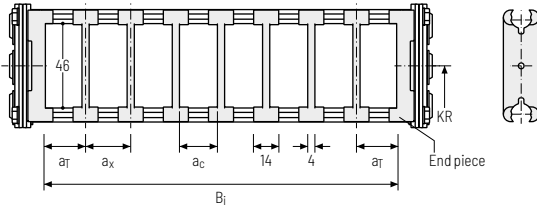

Divider system TS1 with continuous height separation

Vers.	a _T min [mm]	a _x min [mm]	a _c min [mm]	n _T min
A	12	14	10	2

The dividers can be moved in the cross section.

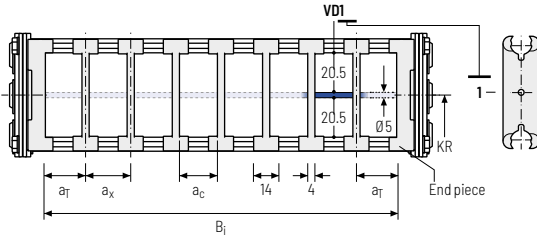

Order example

TS1 · A · 3 - VD0
VD1
 Divider system Version n_T Height separation

Please state the designation of the divider system (**TS0, TS1...**), version and number of dividers per cross section [n_T].

If using divider systems with height separation (**TS1**) please also state the positions [e.g. VD1] viewed from the left driver belt. You are welcome to add a sketch to your order.

The end pieces are part of the divider system and don't have to be ordered separately.

MT series
XLT series
ROBOTRAX® System
FLATVEVOR®
CLEANVEVOR®
LS/LSX series
S/SX series
S/SX-Tubes series
Accessories
TRAXLINE®

Aluminum stay RS 2 – frame stay narrow, threaded joint

- » Quick to open and close
- » Aluminum profile bars for light to medium loads.
Simple threaded joint
- » Available customized in **1 mm width sections**.
- » **Outside/inside:** Threaded joint easy to release.



Stay arrangement on every
2nd chain link, standard
(HS: half-stayed)



Stay arrangement on each
chain link **(VS: fully-stayed)**



1 mm B_k from 150 – 400 mm
in **1 mm width sections**

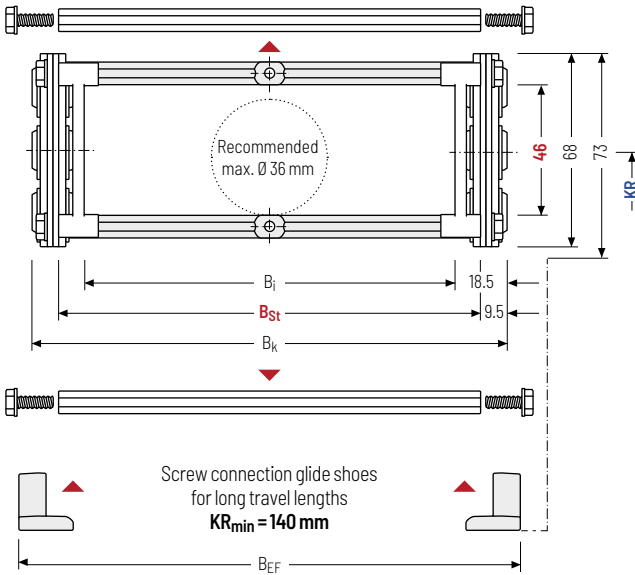

The maximum cable diameter strongly depends on the bending radius and the desired cable type. Please contact us.

Calculating the cable carrier length

Cable carrier length L_k

$$L_k \approx \frac{L_S}{2} + L_B$$

Cable carrier length L_k
rounded to pitch t

h _i [mm]	h _G [mm]	h _{G'} [mm]	B _i [mm]	B _{St} [mm]*	B _k [mm]	B _{EF} [mm]	KR [mm]					q _k [kg/m]
46	68	73	113 363	131 381	B _{St} + 19	B _{St} + 28	125	140	170	200	260	7.55
							290	320	350	400	600	8.21

* in 1 mm width sections

Order example



S0950

Type

150

B_{St}[mm]

RS 2

Stay variant

200

KR[mm]

St

Material

2375

L_k[mm]

HS

Stay arrangement

Divider systems

The divider system is mounted on each crossbar as a standard – on every 2nd chain link for stay mounting (HS).

As a standard, dividers or the complete divider system (dividers with height separations) are movable in the cross section (**version A**).

For applications with lateral acceleration and rotated by 90°, the dividers can be attached by simply clipping onto a socket (available as an accessory).

This socket additionally acts as a spacer between the dividers and is available in a 1 mm grid between 3 – 50 mm, as well as 16.5 and 21.5 mm (**version B**).

Divider system TSO without height separation

Vers.	a _T min [mm]	a _x min [mm]	a _c min [mm]	n _T min
A	12	14	10	-

The dividers can be moved in the cross section.

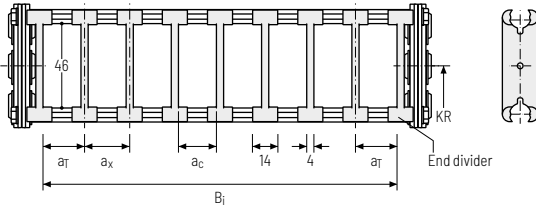

Divider system TS1 with continuous height separation

Vers.	a _T min [mm]	a _x min [mm]	a _c min [mm]	n _T min
A	12	14	10	2

The dividers can be moved in the cross section.

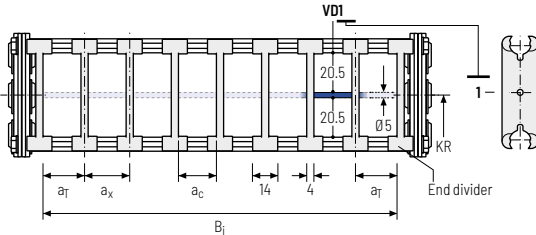

Order example

TS1 ·
 A ·
 3 -
 V D0
 :
 - V D1

Divider system
Version
n_T
Height separation

Please state the designation of the divider system (**TS0, TS1...**), version and number of dividers per cross section [n_T].

If using divider systems with height separation (**TS1**) please also state the positions [e.g. V D1] viewed from the left driver belt. You are welcome to add a sketch to your order.

The end dividers are part of the divider system and don't have to be ordered separately.

	MT series
	XLT series
	ROBOTRAX® System
	FLATVEVOR®
	CLEANVEVOR®
	LS/LSX series
	S/SX series
	S/SX-Tubes series
	Accessories
	TRAXLINE®

Aluminum stay RM – frame stay, solid

- » Aluminum profile bars for heavy loads and maximum cable carrier widths. Double threaded joint on both sides “**Heavy Duty**”.
- » Available customized in **1 mm grid**.
- » **Inside/outside:** Threaded joints easy to release.

HEAVY DUTY
TSUBAKI KABELSCHLEPP



Stay arrangement on every
2nd chain link, standard
(HS: half-stayed)



Stay arrangement on each
chain link (VS: fully-stayed)



1mm B_k from 125 – 600 mm
in **1 mm** width sections

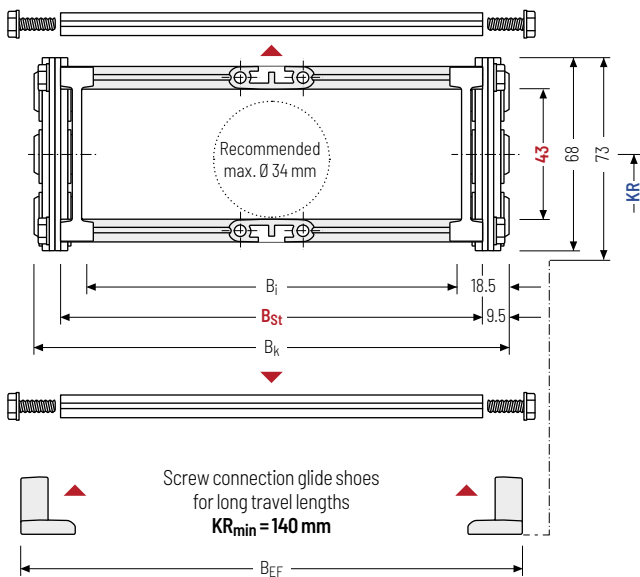

The maximum cable diameter strongly depends on the bending radius and the desired cable type. Please contact us.

Calculating the cable carrier length

Cable carrier length L_k

$$L_k \approx \frac{L_S}{2} + L_B$$

Cable carrier length L_k
rounded to pitch t

h _i [mm]	h _G [mm]	h _{G'} [mm]	B _i [mm]	B _{St} [mm]*	B _k [mm]	B _{EF} [mm]	KR [mm]				q _k [kg/m]	
43	68	73	88 563	106 581	B _{St} + 19	B _{St} + 28	125	140	170	200	260	7.78
							290	320	350	400	600	10.68

* in 1 mm width sections

Order example



S0950

Type

150

B_{St}[mm]

RM

Stay variant

200

KR[mm]

St

Material

2375

L_k[mm]

HS

Stay arrangement

Divider systems

The divider system is mounted on each crossbar as a standard – on every 2nd chain link for stay mounting (HS).

As a standard, dividers or the complete divider system (dividers with height separations) are movable in the cross section (**version A**).

Divider system TSO without height separation

Vers.	a _T min [mm]	a _x min [mm]	a _c min [mm]	n _T min
A	10	14	10	-

The dividers can be moved in the cross section.

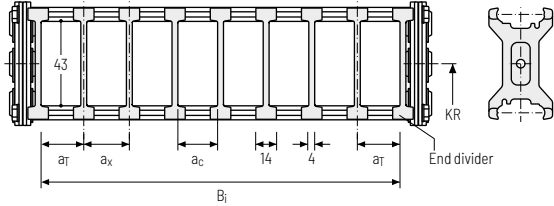

Divider system TS1 with continuous height separation

Vers.	a _T min [mm]	a _x min [mm]	a _c min [mm]	n _T min
A	10	14	10	2

The dividers can be moved in the cross section.

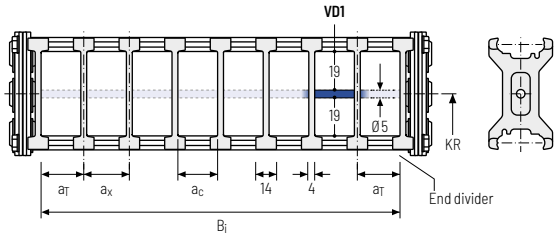

Order example

TS1 ·
 A ·
 3 -
 VD0
 :
 - VD1

Divider system
Version
n_T
Height separation

Please state the designation of the divider system (**TS0, TS1...**), version and number of dividers per cross section [n_T].

If using divider systems with height separation (**TS1**) please also state the positions [e.g. VD1] viewed from the left driver belt. You are welcome to add a sketch to your order.

The end dividers are part of the divider system and don't have to be ordered separately.

MT series
XLT series
ROBOTRAX® System
FLATVEVOR®
CLEANVEVOR®
LS/LSX series
S/SX series
S/SX-Tubes series
Accessories
TRAXLINE®

Tube stay RR – frame stay, tube version

- » Steel rolling stays with gentle cable support and plastic dividers. Ideal for using media hoses with soft sheathing. Easy screw connection.
- » Available customized in **1 mm width sections**.
- » **Inside/outside:** Screw connection detachable
- » **Option:** Divider systems made from steel and stainless steel ER 1, ER 1S.



Stay arrangement on every
2nd chain link standard
(HS: half-stayed)



Stay arrangement on each
chain link **(VS: fully-stayed)**



1 mm B_i 150 – 500 mm
in **1 mm width sections**

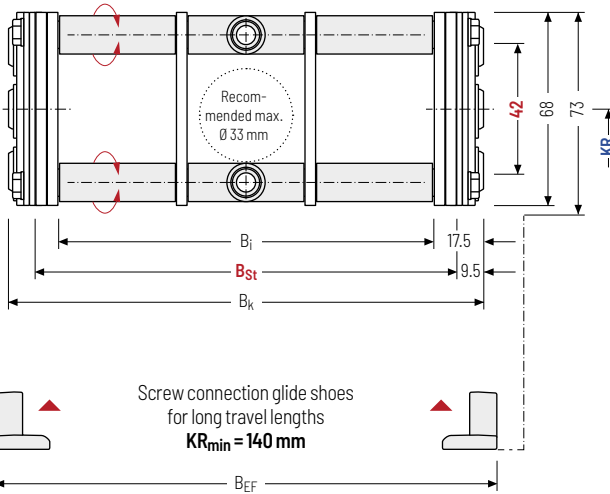

The maximum cable diameter strongly depends on the bending radius and the desired cable type. Please contact us.

Calculating the cable carrier length

Cable carrier length L_k

$$L_k \approx \frac{L_S}{2} + L_B$$

Cable carrier length L_k
rounded to pitch t

h_i [mm]	h_G [mm]	h_G' [mm]	B_i [mm]	B_{St} [mm]*	B_k [mm]	B_{EF} [mm]	KR [mm]					q_k [kg/m]
42	68	73	115 465	131 481	$B_{St} + 19$	$B_{St} + 28$	125	140	170	200	260	8.42
							290	320	350	410	600	11.75

* in 1 mm width sections

Order example



S0950

Type

150

B_{St} [mm]

RR

Stay variant

200

KR [mm]

St

Material

2375

L_k [mm]

HS

Stay arrangement

Divider systems

As a standard, the divider system is mounted on each crossbar – for stay mounting on every 2nd chain link (HS).

The dividers are fixed through the tubes. The tube additionally serves as a spacer between the dividers (**version B**).

Divider system TSO without height separation

Vers.	a _T min [mm]	a _x min [mm]	a _c min [mm]	n _T min
B	20	20	16	-

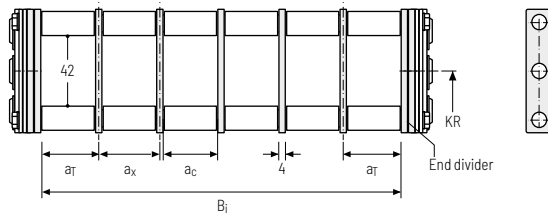

Divider system TS1 with continuous height separation

Vers.	a _T min [mm]	a _x min [mm]	a _c min [mm]	n _T min
B	20	20	16	2

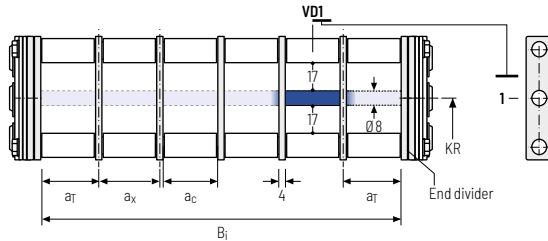

Order example

TS1

·

B

·

3

·

K1

·

34

-

V00

⋮

⋮

⋮

K4

·

38

-

V00

Divider system
Version
n_T
Chamber
a_x
Height separation

Please state the designation of the divider system (**TS0, TS1...**), version and number of dividers per cross section [n_T]. In addition, please also enter the chambers [K] from left to right, as well as the assembly distances [a_T/a_x] (as seen from the driver).

TRAXLINE® cables for cable carriers

Hi-flex electric cables which were especially developed, optimized and tested for use in cable carriers can be found at tsubaki-kabelschlepp.com/traxline

MT series
XLT series
ROBOTRAX® System
FLATVEVOR®
CLEANVEVOR®
LS/LSX series
S/SX series
S/SX-Tubes series
Accessories
TRAXLINE®

Aluminum stay LG - hole stay, split version

- » Optimum cable routing in the neutral bending line.
Split version for easy cable routing. Stays also available unsplit.
- » Available customized in **1 mm grid**.
- » **Inside/outside:** Threaded joint easy to release.

HEAVY DUTY
TSUBAKI KABELSCHLEPP

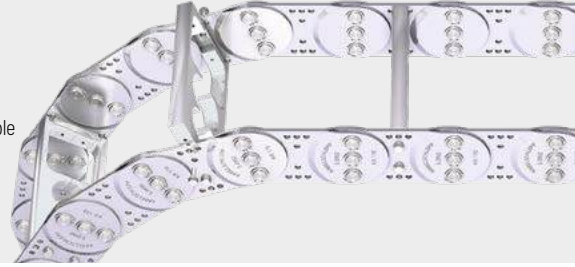

Stay arrangement on every
2nd chain link standard
(HS: half-stayed)



Stay arrangement on each
chain link **(VS: fully-stayed)**



1mm B_i 125 – 600 mm
in **1 mm width sections**

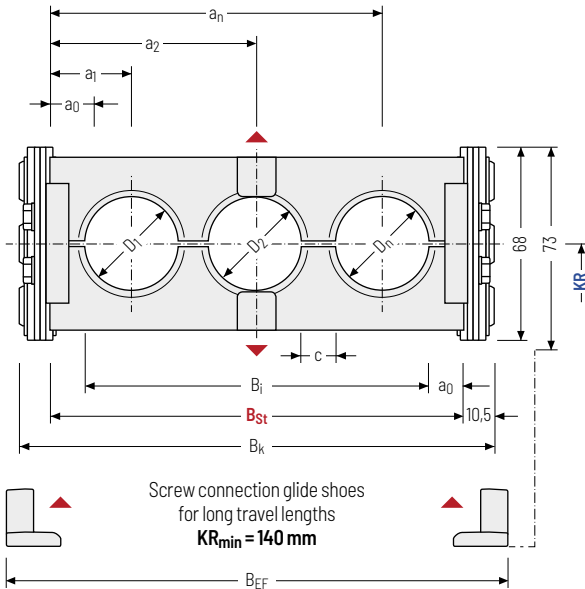

The maximum cable diameter strongly depends on the bending radius and the desired cable type. Please contact us.

Calculating the cable carrier length

Cable carrier length L_k

$$L_k \approx \frac{L_S}{2} + L_B$$

Cable carrier length L_k
rounded to pitch t

Calculating the stay width

Stay width B_{St}

$$B_{St} = \sum D + \sum c + 2 a_0$$

D _{max} [mm]	D _{min} [mm]	h _G [mm]	h _{G'} [mm]	B _i [mm]	B _{St} [mm]*	B _k [mm]	B _{EF} [mm]	c _{min} [mm]	a ₀ min [mm]	KR [mm]				q _k 50%** [kg/m]
50	12	68	73	82	104	B _{St} +	B _{St} +	4	11	125	140	170	200	7.97
				-	-	21	30			260	290	320	350	-
				557	579					410	600			11.82

* in 1 mm width sections ** Hole ratio of the hole stay approx. 50 %

Order example



S0950

Type

150

B_{St} [mm]

LG

Stay variant

200

KR [mm]

St

Material

2375

L_k [mm]

HS

Stay arrangement

End connectors - steel

End connectors made of steel. The connection variants on the fixed point and on the driver can be combined and changed later on, if necessary.

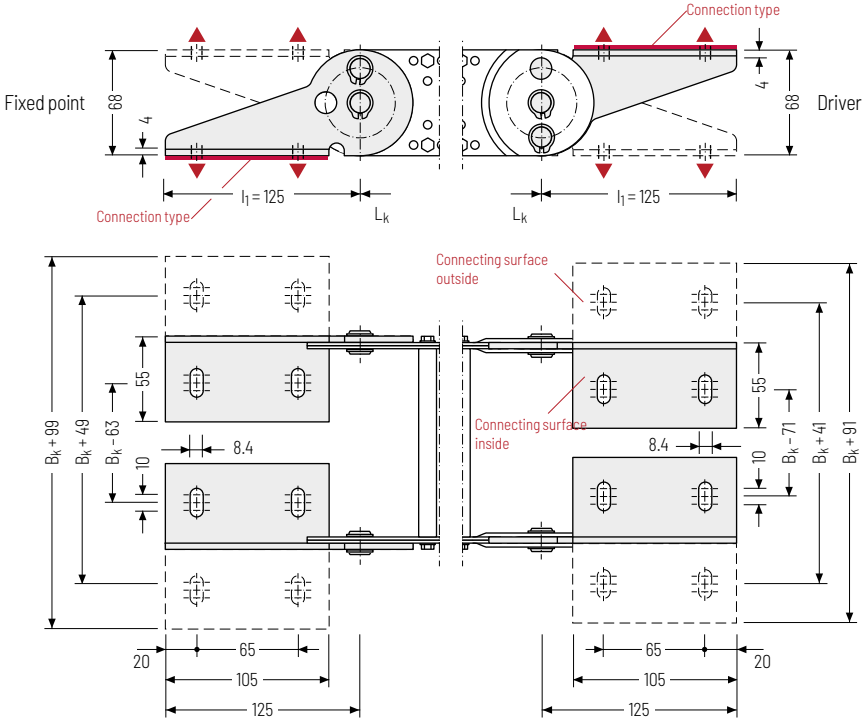

▲ Assembly options

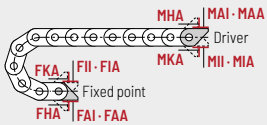

Connection point

- F - fixed point
- M - driver

Connection type

- A - threaded joint to outside (standard)
- I - threaded joint to inside
- H - threaded joint, rotated 90° to the outside
- K - threaded joint, rotated 90° to the inside

Connection surface

- I - connection surface inside (standard)
- A - connection surface outside

Caution: The standard connection variant FAI/MAI is only possible from B_k of 122 mm.

Order example

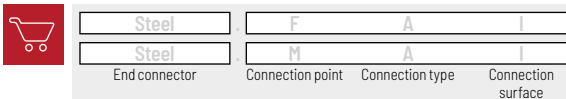

Caution: We recommend the use of strain reliefs at the driver and fixed point. See from p. 904.

MT series
XLT series
ROBOTRAX® System
FLATVEYOR®
CLEANVEYOR®
LS/LSX series
S/SX series
S/SX-Tubes series
Accessories
TRAXLINE®

S/SX1250

MT
seriesXLT
seriesROBOTRAX®
System

FLATVEYOR®

CLEANVEYOR®

LS/LSX
seriesS/SX
seriesS/SX-Tubes
series

Accessories

TRAXLINE®



Pitch
125 mm



Inner heights
66 – 76 mm



Chain widths
130 – 800 mm



Bending radii
145 – 1000 mm

Stay variants



Aluminum stay RS 1 page 724

Frame stay narrow "The standard"

- » Aluminum profile bars for light to medium loads.
- » **Outside:** release by turning by 90°.
- » **Inside:** Threaded joints easy to release.



Aluminum stay RS 2 page 728

Frame stay narrow, bolted

- » Aluminum profile bars for light to medium loads. Simple threaded joint.
- » **Outside/inside:** Threaded joints easy to release.



Aluminum stay RV page 732

Frame stay, reinforced

- » Aluminum profile bars for medium to heavy loads and large cable carrier widths. Double threaded joint on both sides.
- » **Inside/outside:** Threaded joints easy to release.



Aluminum stay RM page 736

Frame stay, solid

- » Aluminum profile bars for heavy loads and maximum cable carrier widths. Double threaded joint on both sides "**Heavy Duty**".
- » **Inside/outside:** Threaded joints easy to release.



TRAXLINE® cables for cable carriers

Hi-flex electric cables which were specially developed, optimised and tested for use in cable carriers can be found at tsubaki-kabelschlepp.com/traxline.



Aluminum stay RR page 738

Frame stay, tube version

- » Steel rolling stays with gentle cable support and steel dividers. Ideal for using media hoses with soft sheathing.
- » **Inside/outside:** Screw connection detachable.

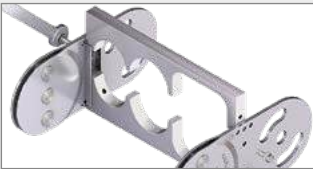

Aluminum stay LG page 740

Frame stay, split

- » Optimum cable routing in the neutral bending line. Split version for easy cable routing. Stays also available unsplit.
- » **Inside/outside:** Threaded joint easy to release.



S/SX tubes

Also available as covered variants with cover system or steel band cover. More information can be found in chapter "S/SX tubes" from p. 802.

Additional stay variants on request



Aluminum stay RMA

For guiding very large cable diameters



Aluminum stay RMR

Gentle cable guiding with rollers.

Unsupported arrangement

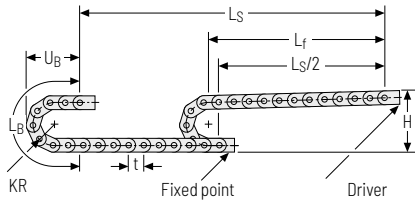

KR [mm]	H [mm]	L _B [mm]	U _B [mm]
145	431	955	442
200	541	1128	497
220	581	1191	517
260	661	1317	557
300	741	1442	597
340	821	1568	637
380	901	1694	677
420	981	1820	717
460	1061	1945	757
500	1141	2071	797
540	1221	2196	837
600	1341	2385	897
1000	2141	3640	1297

Installation height H_Z

$$H_z = H + 10 \text{ mm/m}$$

Load diagram for unsupported length depending on the additional load.

Intrinsic cable carrier weight $q_k = 13 \text{ kg/m}$. For other inner widths, the maximum additional load changes.



Speed
up to 2.5 m/s



Acceleration
up to 5 m/s²



Travel length
up to 13.5 m



Additional load
up to 50 kg/m

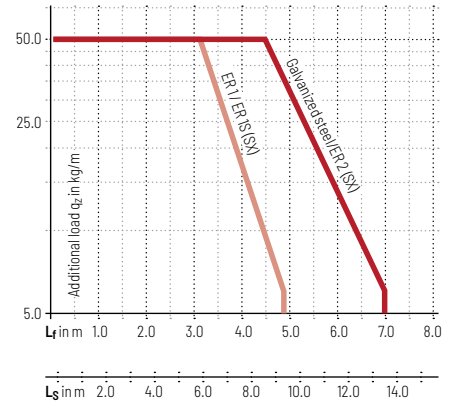

Gliding arrangement

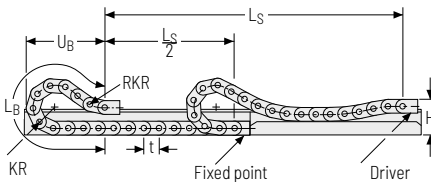

The gliding cable carrier must be guided in a channel.
See p. 844.

Glide shoes have to be used for gliding applications.



Speed
up to 1 m/s



Acceleration
up to 2 m/s²



Travel length
on request



Additional load
up to 50 kg/m

MT
seriesXLT
seriesROBOTRAX®
System

FLATVEYOR®

CLEANVEYOR®

LS/LSX
seriesS/SX
seriesS/SX-Tubes
series

Accessories

TRAXLINE®

Aluminum stay RS 1 - frame stay narrow

- » Extremely quick to open and close
- » Aluminum profile bars for light to medium loads.
- » Available customized in **1 mm width sections**.
- » **Outside:** release by rotating 90°.
- » **Inside:** Threaded joint easy to release.



Stay arrangement on every
2nd chain link, standard
(HS: half-stayed)



Stay arrangement on each
chain link **(VS: fully-stayed)**



1 mm B_k from 200 – 400 mm
in **1 mm width sections**

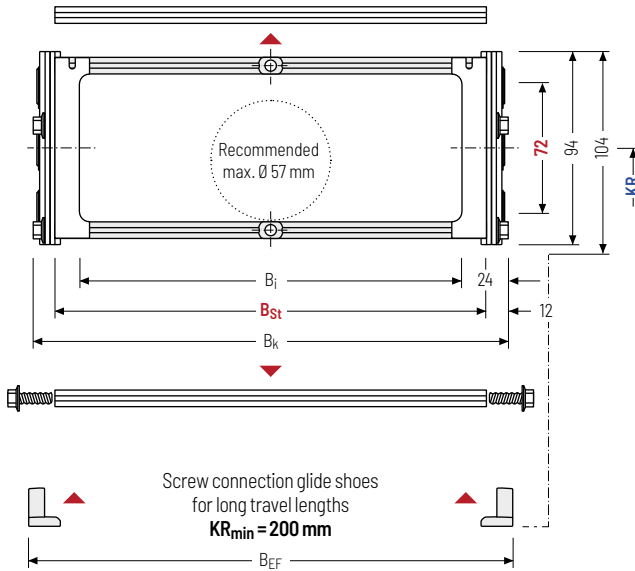

The maximum cable diameter strongly depends on the bending radius and the desired cable type. Please contact us.

Calculating the cable carrier length

Cable carrier length L_k

$$L_k \approx \frac{L_S}{2} + L_B$$

Cable carrier length L_k
rounded to pitch t

h _i [mm]	h _G [mm]	h _G ' [mm]	B _i [mm]	B _{St} [mm]*	B _k [mm]	B _{EF} [mm]	KR [mm]						q _k [kg/m]	
72	94	104	152	176	B _{St} + 24	B _{St} + 30	145	200	220	260	300	340	380	12.88
			352	376			420	460	500	540	600	1000		13.43

* in 1 mm width sections

Order example



S1250

Type

400

B_{St}[mm]

RS 1

Stay variant

200

KR[mm]

St

Material

4750

L_k[mm]

HS

Stay arrangement

Divider systems

The divider system is mounted on each crossbar as a standard – on every 2nd chain link for stay mounting (HS).

As a standard, dividers or the complete divider system (dividers with height separations) are movable in the cross section (**version A**).

For applications with lateral acceleration and rotated by 90°, the dividers can be attached by simply clipping onto a socket (available as an accessory).

The socket additionally acts as a spacer between the dividers and is available in 1 mm increments between 3 – 50 mm (**version B**).

Divider system TSO without height separation

Vers.	a _T min [mm]	a _x min [mm]	a _c min [mm]	n _T min
A	12.5	15	10	-

The dividers can be moved in the cross section.

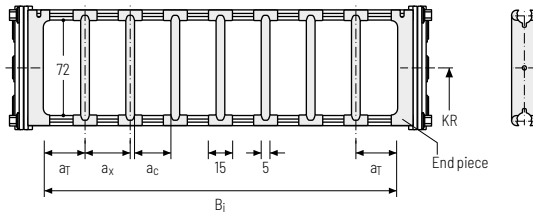

Divider system TS1 with continuous height separation

Vers.	a _T min [mm]	a _x min [mm]	a _c min [mm]	n _T min
A	12.5	15	10	2

The dividers can be moved in the cross section.

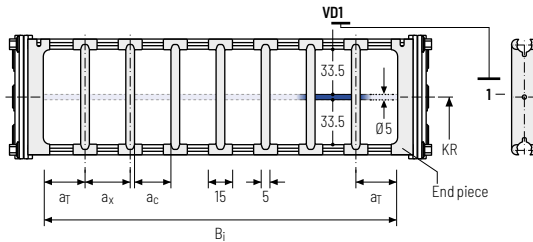

Order example

TS1

A

3

VD0

⋮

VD1

Divider system

Version

n_T

Height separation

Please state the designation of the divider system (**TS0, TS1...**), version and number of dividers per cross section [n_T].

If using divider systems with height separation (**TS1**) please also state the positions [e.g. VD1] viewed from the left driver belt. You are welcome to add a sketch to your order.

The end pieces are part of the divider system and don't have to be ordered separately.

MT series
XLT series
ROBOTRAX® System
FLATVEVOR®
CLEANVEVOR®
LS/LSX series
S/SX series
S/SX-Tubes series
Accessories
TRAXLINE®

Divider system TS3 with height separation consisting of plastic partitions

As a standard, the divider version A is used for vertical partitioning within the cable carrier. The complete divider system can be moved within the cross section.

MT series

XLT series

ROBOTRAX® System

FLATVEYOR®

CLEANVEYOR®

LS/LSX series

S/SX series

S/SX-Tubes series

Accessories

TRAXLINE®

Divider version A

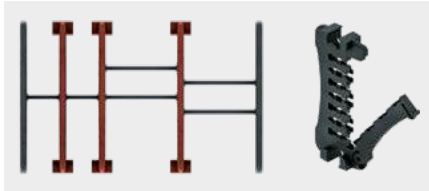

End divider

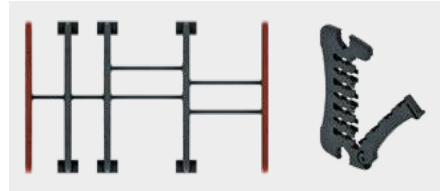

Vers.	a_T min [mm]	a_x min [mm]	a_c min [mm]	n_T min
A	7*/11	14	10	2

* For End divider

The dividers are fixed by the partitions, the complete divider system is movable in the cross section.

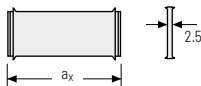
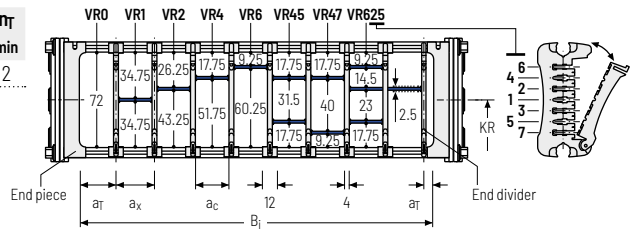

a_x (center distance of dividers) [mm]																
a_c (nominal width of inner chamber) [mm]																
14	16	19	23	24	28	29	32	33	34	38	39	43	44	48	49	54
10	12	15	19	20	24	25	28	29	30	34	35	39	40	44	45	50
58	59	64	68	69	74	78	79	80	84	88	89	94	96	99	112	
54	55	60	64	65	70	74	75	76	80	84	85	90	92	95	108	

When using partitions with $a_x > 49$ mm we recommend an additional preferential central support.

Order example



TS3	A	3	K1	34	VR1
			:	:	:
			K4	38	VR3
Divider system	Version	n_T	Chamber	a_x	Height separation

Please state the designation of the divider system (TS0, TS1,...), version and number of dividers per cross section [n_T]. In addition, please also enter the chambers [K] from left to right, as well as the assembly distances [a_T/a_x] (as seen from the driver).

If using divider systems with height separation (TS1, TS3) please also state the positions [e.g. VD23] viewed from the left driver belt. You are welcome to add a sketch to your order.



Subject to change without notice.

MT
series

XLT
series

ROBOTRAX®
System

FLATVEYOR®

CLEANVEYOR®

LS/LSX
series

S/SX
series

S/SX-Tubes
series

Accessories

TRAXLINE®

Aluminum stay RS 2 – frame stay narrow, threaded joint

- » Quick to open and close
- » Aluminum profile bars for light to medium loads.
Simple threaded joint
- » Available customized in **1 mm width sections**.
- » **Outside/inside:** Threaded joint easy to release.

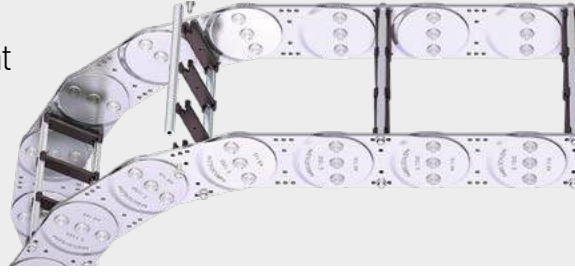

Stay arrangement on every
2nd chain link, standard
(HS: half-stayed)



Stay arrangement on each
chain link **(VS: fully-stayed)**



1 mm B_k from 200 – 500 mm
in **1 mm width sections**

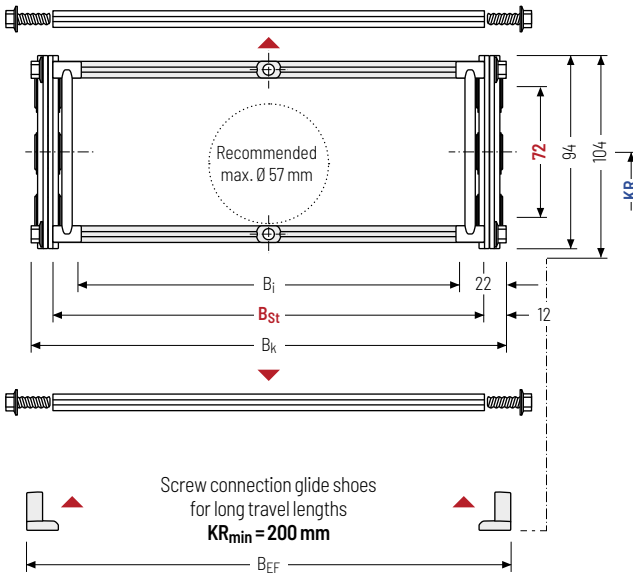

The maximum cable diameter strongly depends on the bending radius and the desired cable type. Please contact us.

Calculating the cable carrier length

Cable carrier length L_k

$$L_k \approx \frac{L_S}{2} + L_B$$

Cable carrier length L_k
rounded to pitch t

h _i [mm]	h _G [mm]	h _{G'} [mm]	B _i [mm]	B _{St} [mm]*	B _k [mm]	B _{EF} [mm]	KR [mm]				q _k [kg/m]			
72	94	104	156	176	B _{St} + 24	B _{St} + 30	145	200	220	260	300	340	380	12.88
			456	476			420	460	500	540	600	1000		13.71

* in 1 mm width sections

Order example



S1250

Type

400

B_{St}[mm]

RS 2

Stay variant

200

KR[mm]

St

Material

4750

L_k[mm]

HS

Stay arrangement

Divider systems

The divider system is mounted on each crossbar as a standard – on every 2nd chain link for stay mounting (HS).

As a standard, dividers or the complete divider system (dividers with height separations) are movable in the cross section (**version A**).

For applications with lateral acceleration and rotated by 90°, the dividers can be attached by simply clipping onto a socket (available as an accessory).

The socket additionally acts as a spacer between the dividers and is available in 1 mm increments between 3 – 50 mm (**version B**).

Divider system TSO without height separation

Vers.	a _T min [mm]	a _x min [mm]	a _c min [mm]	n _T min
A	12.5	15	10	-

The dividers can be moved in the cross section.

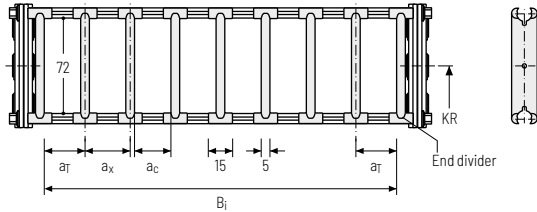

Divider system TS1 with continuous height separation

Vers.	a _T min [mm]	a _x min [mm]	a _c min [mm]	n _T min
A	12.5	15	10	2

The dividers can be moved in the cross section.

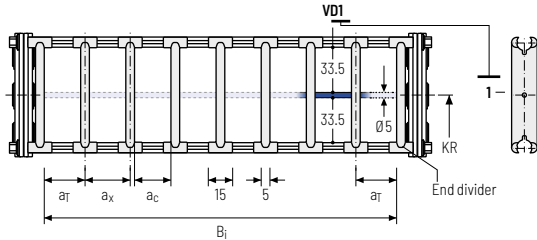

Order example

TS1 ·
 A ·
 3 -
 VD0
 :
 - VD1

Divider system
Version
n_T
Height separation

Please state the designation of the divider system (**TS0, TS1...**), version and number of dividers per cross section [n_T].

If using divider systems with height separation (**TS1**) please also state the positions [e.g. VD1] viewed from the left driver belt. You are welcome to add a sketch to your order.

The end dividers are part of the divider system and don't have to be ordered separately.

MT series
XLT series
ROBOTRAX® System
FLATVEVOR®
CLEANVEVOR®
LS/LSX series
S/SX series
S/SX-Tubes series
Accessories
TRAXLINE®

Divider system TS3 with height separation consisting of plastic partitions

As a standard, the divider version A is used for vertical partitioning within the cable carrier. The complete divider system can be moved within the cross section.

MT series

XLT series

ROBOTRAX® System

FLATVEYOR®

CLEANVEYOR®

LS/LSX series

S/SX series

S/SX-Tubes series

Accessories

TRAXLINE®

Divider version A

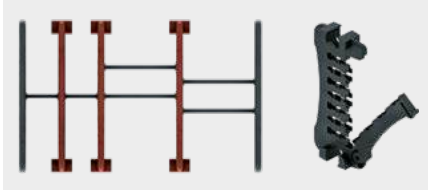

Vers.	a_T min [mm]	a_x min [mm]	a_c min [mm]	n_T min
A	10*/12	14	10	2

* For VR0

The dividers are fixed by the partitions, the complete divider system is movable in the cross section.

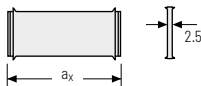
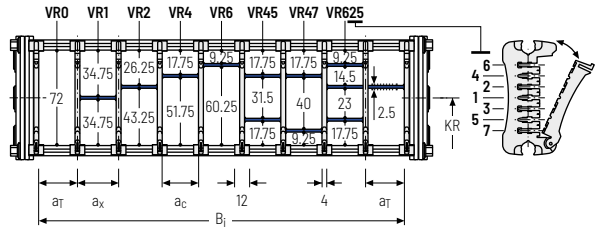

a_x (center distance of dividers) [mm]																
a_c (nominal width of inner chamber) [mm]																
14	16	19	23	24	28	29	32	33	34	38	39	43	44	48	49	54
10	12	15	19	20	24	25	28	29	30	34	35	39	40	44	45	50
58	59	64	68	69	74	78	79	80	84	88	89	94	96	99	112	
54	55	60	64	65	70	74	75	76	80	84	85	90	92	95	108	

When using partitions with $a_x > 49$ mm we recommend an additional preferential central support.

Order example



TS3	A	3	K1	34	VR1
			:	:	:
			K4	38	VR3
Divider system	Version	n_T	Chamber	a_x	Height separation

Please state the designation of the divider system (TS0, TS1,...), version and number of dividers per cross section [n_T]. In addition, please also enter the chambers [K] from left to right, as well as the assembly distances [a_T/a_x] (as seen from the driver).

If using divider systems with height separation (TS1, TS3) please also state the positions [e.g. VD23] viewed from the left driver belt. You are welcome to add a sketch to your order.

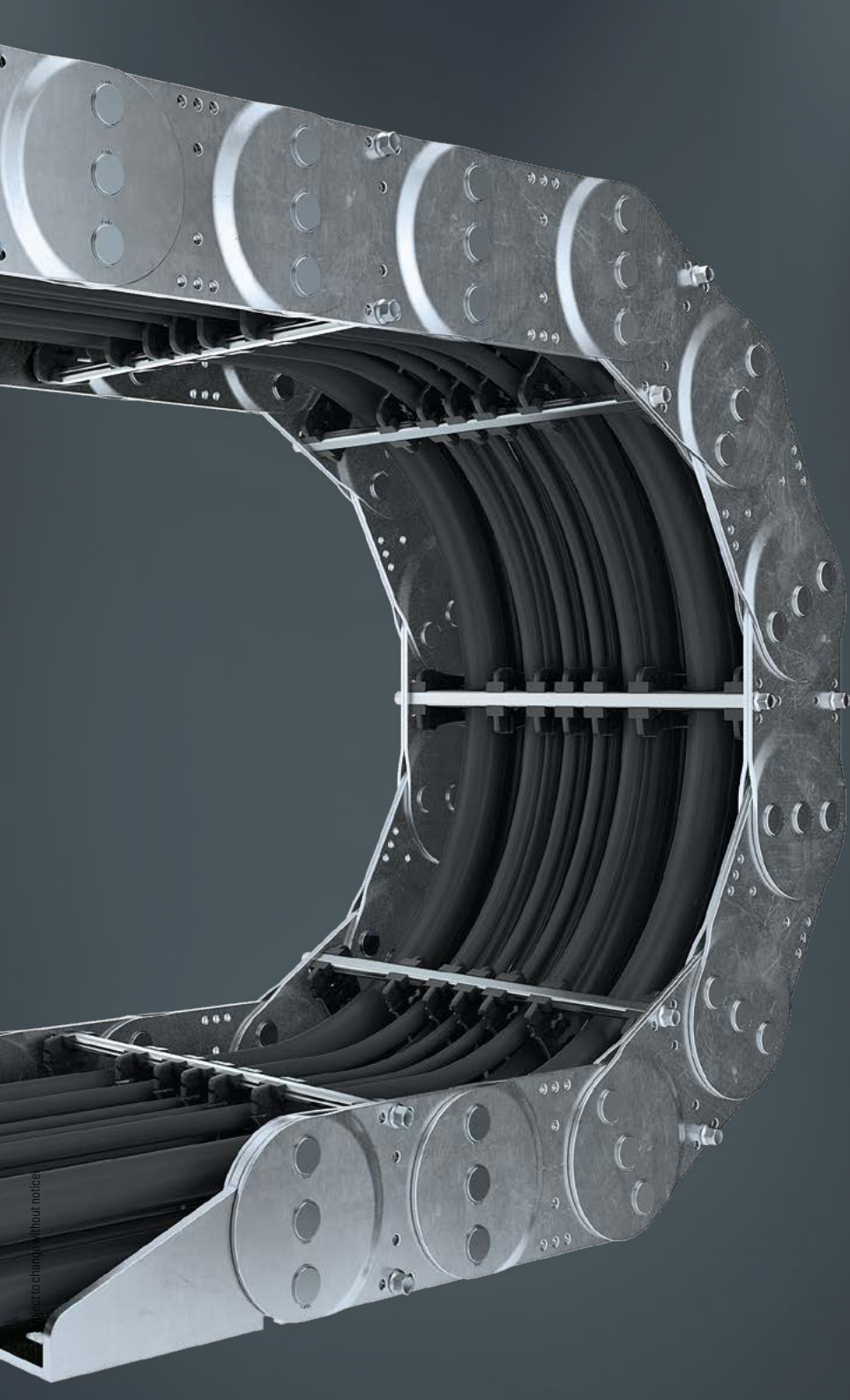

Subject to change without notice

TRAXLINE®

Accessories

S/SX-Tubes series

S/SX series

LS/LSX series

CLEANVEYOR®

FLATVEYOR®

ROBOTRAX® System

XLT series

MT series

Aluminum stay RV – reinforced frame stay

- » Aluminum profile bars for medium to heavy loads and large cable carrier widths. Double threaded joint on both sides.
- » Available customized in **1 mm grid**.
- » **Inside/outside:** Threaded joints easy to release.

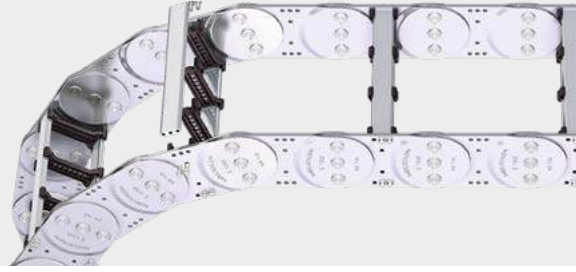

Stay arrangement on every 2nd chain link, standard
(HS: half-stayed)



Stay arrangement on each chain link **(VS: fully-stayed)**



1mm B_k from 200 – 600 mm
in **1 mm width sections**

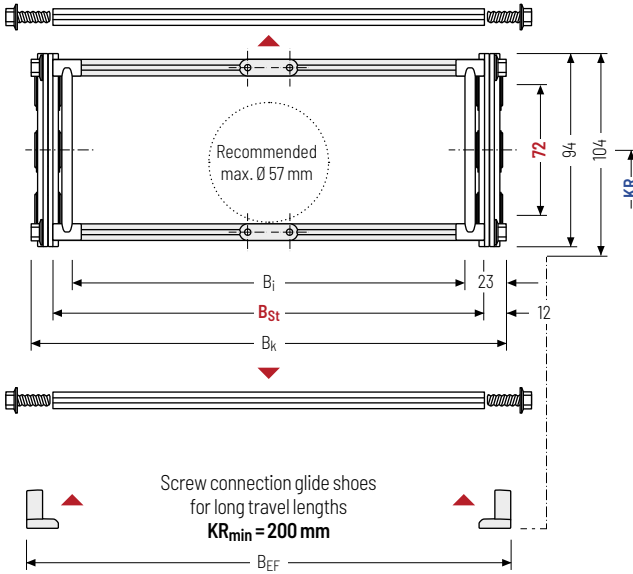

The maximum cable diameter strongly depends on the bending radius and the desired cable type. Please contact us.

Calculating the cable carrier length

Cable carrier length L_k

$$L_k \approx \frac{L_S}{2} + L_B$$

Cable carrier length L_k
rounded to pitch t

h _i [mm]	h _g [mm]	h _{g'} [mm]	B _i [mm]	B _{St} [mm]*	B _k [mm]	B _{EF} [mm]	KR [mm]				q _k [kg/m]			
72	94	104	154	176	B _{St} + 24	B _{St} + 30	145	200	220	260	300	340	380	13.83
			554	576			420	460	500	540	600	1000	17.11	

* in 1 mm width sections

Order example



S1250

Type

400

B_{St}[mm]

RV

Stay variant

200

KR[mm]

St

Material

4750

L_k[mm]

HS

Stay arrangement

Divider systems

The divider system is mounted on each crossbar as a standard – on every 2nd chain link for stay mounting (HS).

As a standard, dividers or the complete divider system (dividers with height separations) are movable in the cross section (**version A**).

Divider system TS0 without height separation

Vers.	a _T min [mm]	a _x min [mm]	a _c min [mm]	π _T min
A	13	16	10	-

The dividers can be moved in the cross section.

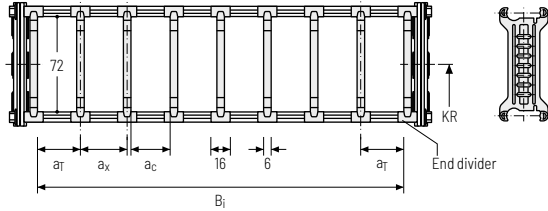

Divider system TS1 with continuous height separation

Vers.	a _T min [mm]	a _x min [mm]	a _c min [mm]	π _T min
A	13	16	10	2

The dividers can be moved in the cross section.

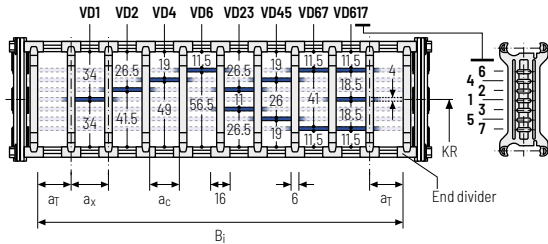

Divider system TS2 with partial height separation

Vers.	a _T min [mm]	a _x min [mm]	a _c min [mm]	π _T min
A	13	21	15	2

With grid distribution (1 mm grid). The dividers are attached by the height separation, the grid can be moved in the cross section.

Sliding dividers are optionally available (thickness of divider = 6 mm).

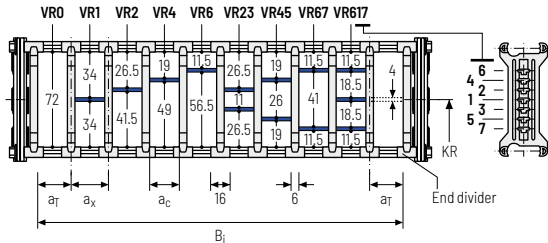

MT series
XLT series
ROBOTRAX® System
FLATVEVOR®
CLEANVEVOR®
LS/LSX series
S/SX series
S/SX-Tubes series
Accessories
TRAXLINE®

More product information online



Assembly instructions etc.: Additional info via your smartphone or check online at tsubaki-kabelschlepp.com/downloads



Configure your custom cable carrier here: online-engineer.de

Divider system TS3 with height separation consisting of plastic partitions

Vers.	a_T min [mm]	a_x min [mm]	a_c min [mm]	n_T min
A	4	16 / 42*	8	2

* For aluminum partitions

The dividers are fixed with the partitions. The entire divider system can be moved in the cross section.

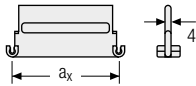
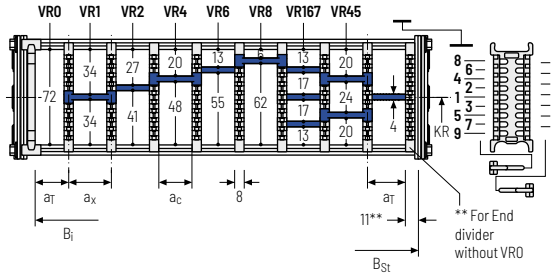

a_x (center distance of dividers) [mm]											
a_c (nominal width of inner chamber) [mm]											
16	18	23	28	32	33	38	43	48	58	64	68
8	10	15	20	24	25	30	35	40	50	56	60
78	80	88	96	112	128	144	160	176	192	208	
70	72	80	88	104	120	136	152	168	184	200	

Aluminum partitions in 1 mm width increments with $a_x > 42$ mm are also available.

When using **plastic partitions with $a_x > 112$ mm**, we recommend an additional center support with a **twin divider** ($S_T = 4$ mm). Twin dividers are also suitable for retrofitting in the partition system.

Order example



TS3	A	3	K1	34	VR1
			:	:	:
			K4	38	VR3
Divider system	Version	n_T	Chamber	a_x	Height separation

Please state the designation of the divider system (TS0, TS1,...), the version, and the number of dividers per cross section [n_T]. In addition, please also enter the chambers [K] from left to right, as well as the assembly distances [a_T/a_x].

When using divider systems with height separation (TS1 – TS3), please additionally state the positions (e.g. VD23) viewed from the left driver belt. You are welcome to add a sketch to your order.

The end dividers are part of the divider system and don't have to be ordered separately.

More product information online



Assembly instructions etc.: Additional info via your smartphone or check online at tsubaki-kabelschlepp.com/downloads



Configure your custom cable carrier here: online-engineer.de

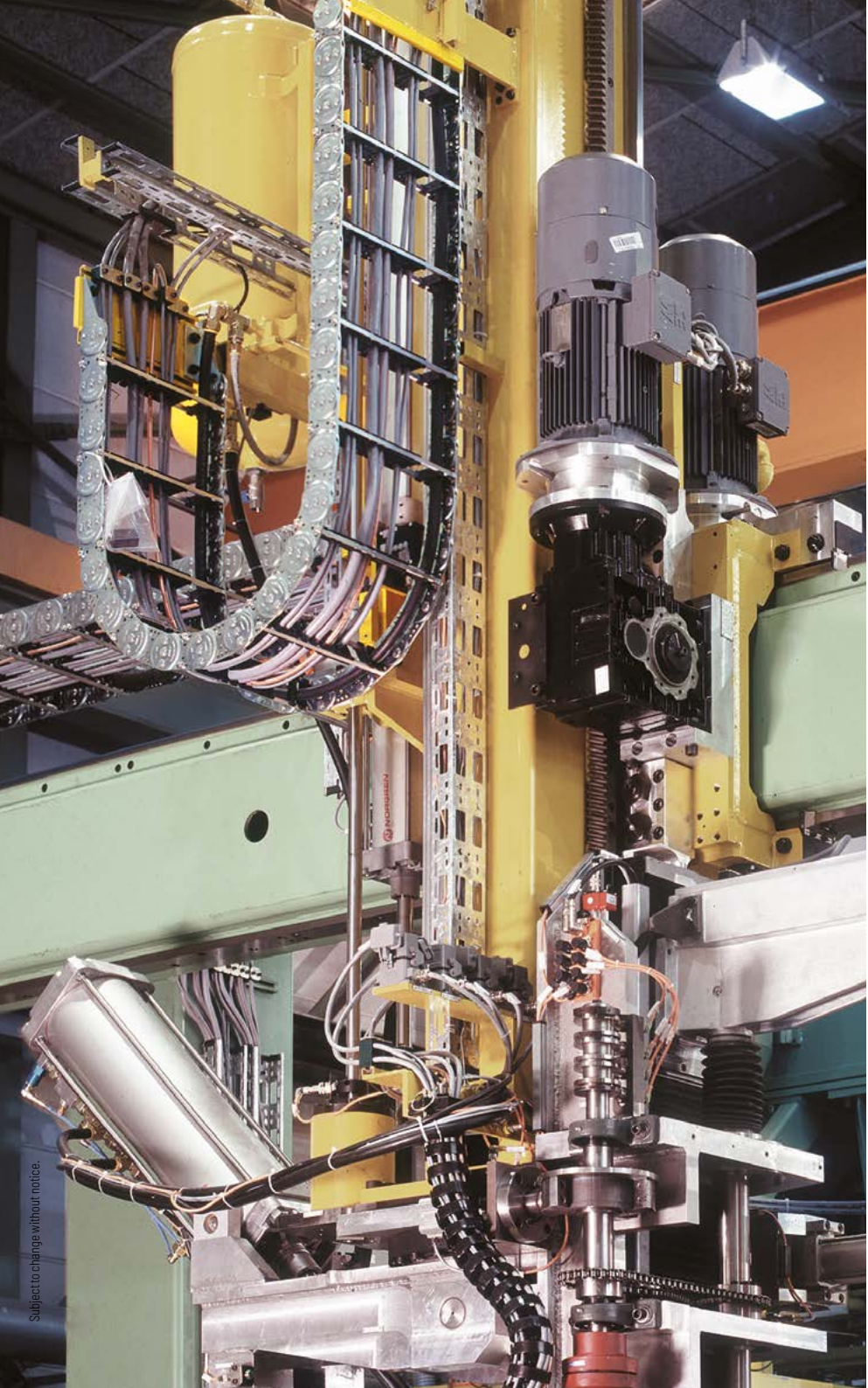

Subject to change without notice.

735

MT
series

XLT
series

ROBOTRAX®
System

FLATVEYOR®

CLEANVEYOR®

LS/LSX
series

S/SX
series

S/SX-Tubes
series

Accessories

TRAXLINE®

Aluminum stay RM -

=

- Aluminum profile bars for heavy loads and maximum cable carrier widths. Double threaded joint on both sides "Heavy Duty".
- Available customized in 1 mm grid.
- Inside/outside:** Threaded joints easy to release.

HEAVY DUTY
 TSUBAKI KABELSCHLEPP

 Stay arrangement on every
 2nd chain link, standard
 (HS: half-stayed)

 Stay arrangement on each
 chain link (VS: fully-stayed)

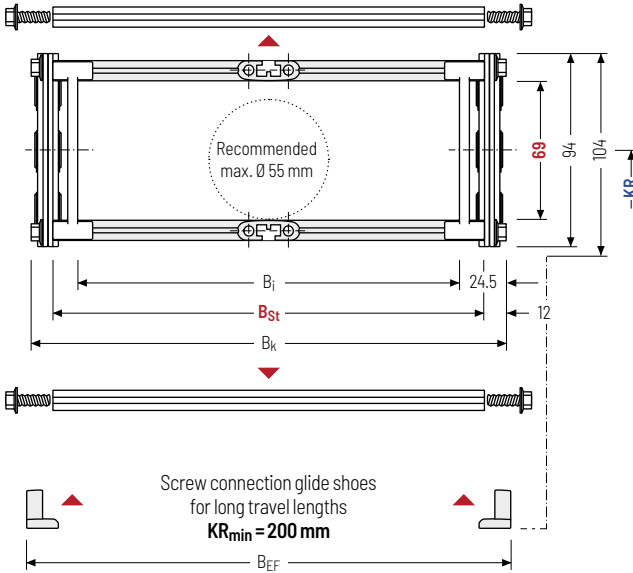
 1 mm B_k from 200 - 800 mm
 in 1 mm width sections

The maximum cable diameter strongly depends on the bending radius and the desired cable type. Please contact us.

Calculating the cable carrier length

Cable carrier length L_k

$$L_k \approx \frac{L_S}{2} + L_B$$

 Cable carrier length L_k
 rounded to pitch t

h _i [mm]	h _g [mm]	h _{g'} [mm]	B _i [mm]	B _{St} [mm]*	B _k [mm]	B _{EF} [mm]	KR [mm]						q _k [kg/m]	
69	94	104	151 751	176 776	B _{St} + 24	B _{St} + 30	145	200	220	260	300	340	380	13.42
							420	460	500	540	600	1000	17.01	

* in 1 mm width sections

Order example



S1250

Type

400

B_{St}[mm]

RM

Stay variant

200

KR[mm]

St

Material

4750

L_k[mm]

HS

Stay arrangement

Divider systems

The divider system is mounted on each crossbar as a standard – on every 2nd chain link for stay mounting (HS).

As a standard, dividers or the complete divider system (dividers with height separations) are movable in the cross section (**version A**).

Divider system TSO without height separation

Vers.	a _T min [mm]	a _x min [mm]	a _c min [mm]	π _T min
A	17.5	20	15	-

The dividers can be moved in the cross section.

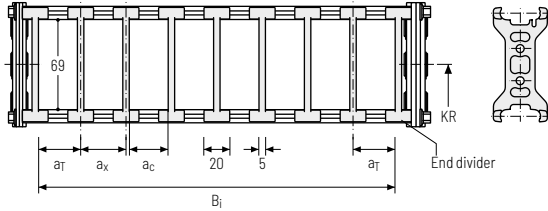

Divider system TS1 with continuous height separation

Vers.	a _T min [mm]	a _x min [mm]	a _c min [mm]	π _T min
A	10	12	8	2

The dividers can be moved in the cross section.

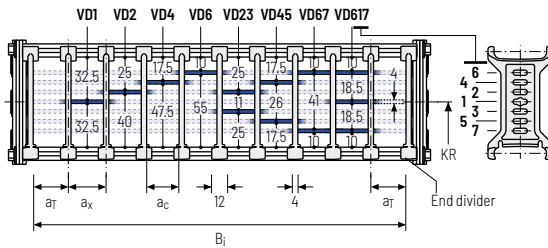

Divider system TS2 with partial height separation

Vers.	a _T min [mm]	a _x min [mm]	a _c min [mm]	π _T min
A	17	21	15	2

With grid distribution (1 mm grid). The dividers are attached by the height separation, the grid can be moved in the cross section.

Sliding dividers are optionally available (thickness of divider = 4 mm).

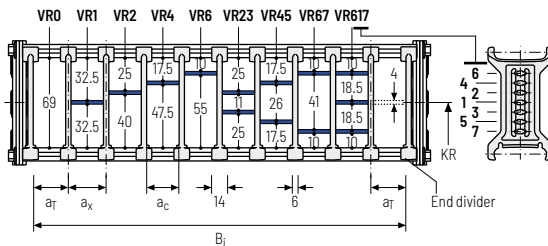

Order example

TS2 ·
 A ·
 3 ·
 K1 ·
 34 ·
 VR1
 :
 :
 :
K4 ·
 38 ·
 VR3
 Divider system Version π_T Chamber a_x Height separation

MT series
XLT series
ROBOTRAX® System
FLATVEVOR®
CLEANVEVOR®
LS/LSX series
S/SX series
S/SX-Tubes series
Accessories
TRAXLINE®

Tube stay RR – frame stay, tube version

- » Steel rolling stays with gentle cable support and plastic dividers. Ideal for using media hoses with soft sheathing. Easy screw connection.
- » Available customized in **1 mm width sections**.
- » **Inside/outside:** Screw connection detachable
- » **Option:** Divider systems made from steel and stainless steel ER 1, ER 1S.



Stay arrangement on every
2nd chain link, standard
(HS: half-stayed)



Stay arrangement on each
chain link **(VS: fully-stayed)**



1 mm B_k from 200 – 800 mm
in **1 mm width sections**

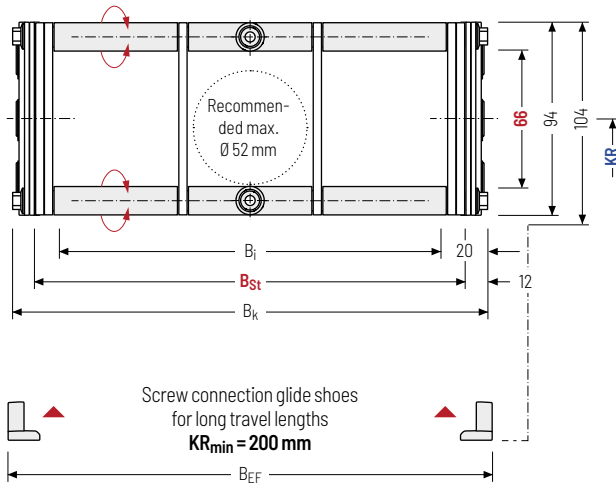

The maximum cable diameter strongly depends on the bending radius and the desired cable type. Please contact us.

Calculating the cable carrier length

Cable carrier length L_k

$$L_k \approx \frac{L_S}{2} + L_B$$

Cable carrier length L_k
rounded to pitch t

h _i [mm]	h _g [mm]	h _{g'} [mm]	B _i [mm]	B _{St} [mm]*	B _k [mm]	B _{EF} [mm]	KR [mm]				q _k [kg/m]			
66	94	104	160 560	176 576	B _{St} + 24	B _{St} + 30	145	200	220	260	300	340	380	13.82
							420	460	500	540	600	1000		17.30

* in 1 mm width sections

Order example



S1250

Type

400

B_{St} [mm]

RR

Stay variant

200

KR [mm]

St

Material

4750

L_k [mm]

HS

Stay arrangement

Divider systems

As a standard, the divider system is mounted on each crossbar – for stay mounting on every 2nd chain link (HS).

The dividers are fixed through the tubes. The tube additionally serves as a spacer between the dividers (**version B**).

Divider system TSO without height separation

Vers.	a _T min [mm]	a _x min [mm]	a _c min [mm]	n _T min
B	30	30	26	-

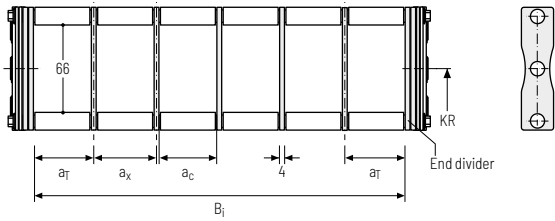

Divider system TS1 with continuous height separation

Vers.	a _T min [mm]	a _x min [mm]	a _c min [mm]	n _T min
B	30	30	26	2

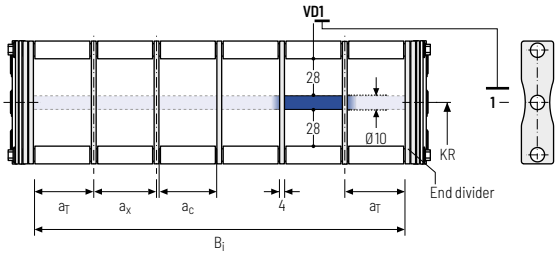

Order example

 · · · · -
 ⋮ ⋮ ⋮
 · -
 Divider system Version n_T Chamber a_x Height separation

Please state the designation of the divider system (**TS0, TS1...**), version and number of dividers per cross section [n_T]. In addition, please also enter the chambers [K] from left to right, as well as the assembly distances [a_T/a_x] (as seen from the driver).

TRAXLINE® cables for cable carriers

Hi-flex electric cables which were especially developed, optimized and tested for use in cable carriers can be found at tsubaki-kabelschlepp.com/traxline

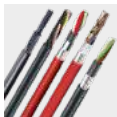

MT series
XLT series
ROBOTRAX® System
FLATVEVOR®
CLEANVEVOR®
LS/LSX series
S/SX series
S/SX-Tubes series
Accessories
TRAXLINE®

Aluminum stay LG - hole stay, split version

- » Optimum cable routing in the neutral bending line.
Split version for easy cable routing. Stays also available unsplit.
- » Available customized in **1 mm grid**.
- » **Inside/outside:** Threaded joint easy to release.

HEAVY DUTY
TSUBAKI KABELSCHLEPP



Stay arrangement on every
2nd chain link standard
(HS: half-stayed)



Stay arrangement on each
chain link **(VS: fully-stayed)**



1mm B_i 130 – 800 mm
in **1 mm width sections**

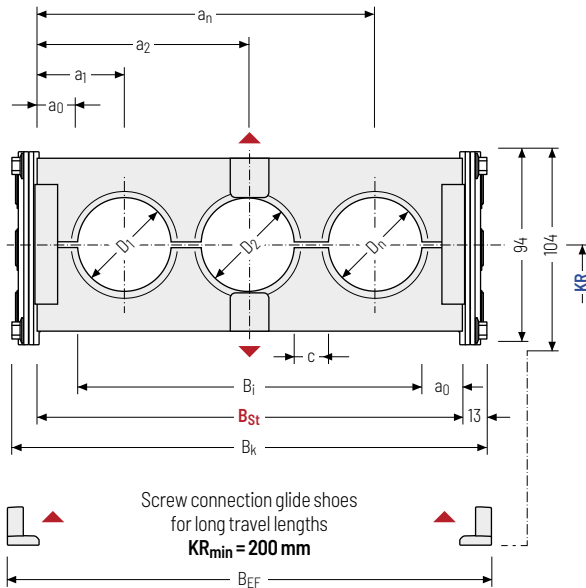

The maximum cable diameter strongly depends on the bending radius and the desired cable type. Please contact us.

Calculating the cable carrier length

Cable carrier length L_k

$$L_k \approx \frac{L_S}{2} + L_B$$

Cable carrier length L_k
rounded to pitch t

Calculating the stay width

Stay width B_{St}

$$B_{St} = \sum D + \sum c + 2 a_0$$

D_{max} [mm]	D_{min} [mm]	h_g [mm]	h_g' [mm]	B_i [mm]	B_{St} [mm]*	B_k [mm]	B_{EF} [mm]	c_{min} [mm]	a_0_{min} [mm]	KR [mm]				q_k 50%** [kg/m]	
76	12	94	104	82	104	$B_{St} +$	$B_{St} +$	4	11	145	200	220	260	300	13.10
				-	-	26	32			340	380	420	460	500	-
				752	774	26	32			540	600	1000	18.22		

* in 1 mm width sections ** Hole ratio of the hole stay approx. 50 %

Order example



S1250

Type

400

B_{St} [mm]

LG

Stay variant

200

KR [mm]

St

Material

4750

L_k [mm]

HS

Stay arrangement



Subject to change without notice.

a Y 51 b
fahren
ab Y 51 kippen

MT series

XLT series

ROBOTRAX® System

FLATVEYOR®

CLEANVEYOR®

LS/LSX series

S/SX series

S/SX-Tubes series

Accessories

TRAXLINE®

End connectors - steel

End connectors made of steel. The connection variants on the fixed point and on the driver can be combined and changed later on, if necessary.

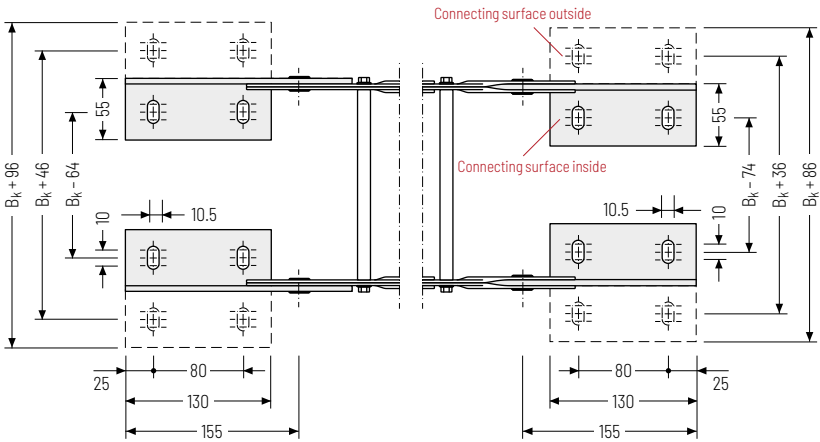
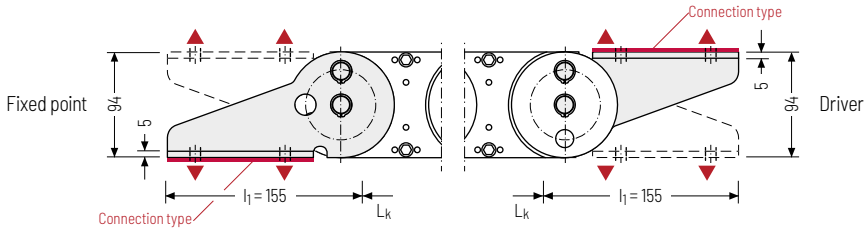

▲ Assembly options

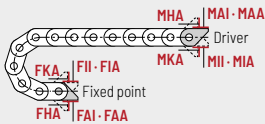

Connection point

F - fixed point
M - driver

Connection type

A - threaded joint to outside (standard)
I - threaded joint to inside
H - threaded joint, rotated 90° to the outside
K - threaded joint, rotated 90° to the inside

Connection surface

I - connection surface inside (standard)
A - connection surface outside

Caution: The standard connection variant FAI/MAI is only possible from B_k of 125 mm.

Order example



Steel	F	A	I
Steel	M	A	I
End connector	Connection point	Connection type	Connection surface



We recommend the use of strain reliefs at the driver and fixed point. See from p. 904.

Special designs

S/SX1252 – with closed stroke system and straight link plates



- » Closed stroke system protected between link plates mounted on both sides.
- » Symmetrical side band design.
- » Long service life even under the toughest conditions, e.g. large amounts of foundry sand, emery or scale thanks to optimized cable carrier geometry.

S/SX1252 B – with internal stroke system and straight link plates

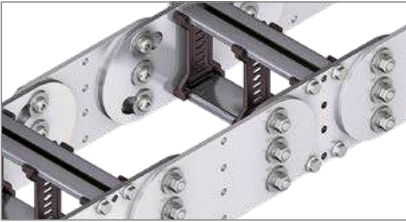

- » Open stroke system.
- » Link plates of the side bands are mounted offset.
- » Long service life even under the toughest conditions, e.g. large amounts of foundry sand, emery or scale thanks to optimized cable carrier geometry.
- » The optimized, "self-cleaning" geometry prevents blocking of the stops through dirt.
- » Version with bolted side bands.

MT series

XLT series

ROBOTRAX® System

FLATVEYOR®

CLEANVEYOR®

LS/LSX series

S/SX series

S/SX-Tubes series

Accessories

TRAXLINE®



TOTALTRAX® complete systems

Benefit from the advantages of a TOTALTRAX complete system. A complete delivery from one source – with a warranty certificate on request! Learn more at tsubaki-kabelschlepp.com/totaltrax



TRAXLINE® cables for cable carriers

Hi-flex electric cables which were especially developed, optimized and tested for use in cable carriers can be found at tsubaki-kabelschlepp.com/traxline

S/SX1800



Pitch
180 mm



Inner height
104 – 110 mm



Chain widths
180 – 1000 mm



Bending radii
265 – 1300 mm

Stay variants



Aluminum stay RM..... page **746**

Frame stay, solid

- » Aluminum profile bars for heavy loads and maximum cable carrier widths. Double threaded joint on both sides **"Heavy Duty"**.
- » **Inside/outside:** Threaded joints easy to release.



Aluminum stay RR..... page **748**

Frame stay, tube version

- » Steel rolling stays with gentle cable support and steel dividers. Ideal for using media hoses with soft sheathing.
- » **Inside/outside:** Screw connection detachable.



Aluminum stay LG..... page **750**

Frame stay, split

- » Optimum cable routing in the neutral bending line. Split version for easy cable routing. Stays also available unsplit.
- » **Inside/outside:** Threaded joint easy to release.



S/SX tubes

Also available as covered variants with cover system or steel band cover. More information can be found in chapter "S/SX tubes" from p. 802.

Unsupported arrangement

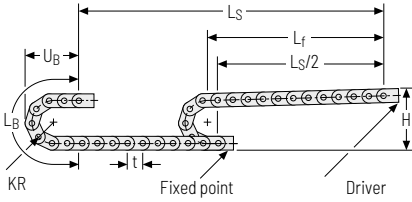

KR [mm]	H [mm]	L _B [mm]	U _B [mm]
265	740	1552	695
320	850	1725	750
375	960	1898	805
435	1080	2087	865
490	1190	2259	920
605	1420	2620	1035
720	1650	2982	1150
890	1990	3516	1320
1175	2560	4411	1605
1300	2810	4804	1730

Installation height H_z

$H_z = H + 10 \text{ mm/m}$

Load diagram for unsupported length depending on the additional load.

Intrinsic cable carrier weight $q_k = 26 \text{ kg/m}$. For other inner widths, the maximum additional load changes.

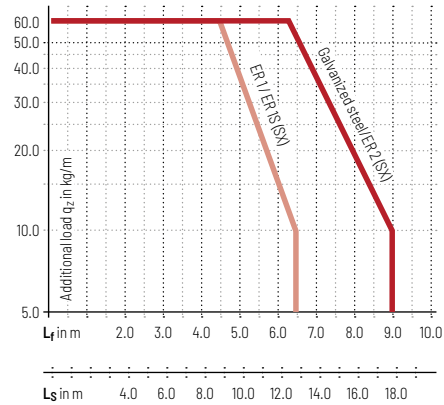

Speed
up to 2 m/s

Acceleration
up to 3 m/s²

Travel length
up to 17.8 m

Additional load
up to 60 kg/m

Gliding arrangement

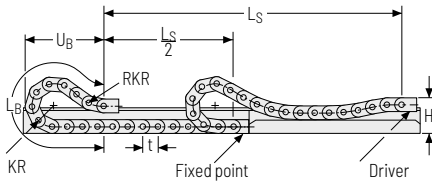

The gliding cable carrier must be guided in a channel. See p. 844.

Glide shoes have to be used for gliding applications.

Speed
up to 0.8 m/s

Acceleration
up to 2 m/s²

Travel length
on request

Additional load
up to 60 kg/m

Aluminum stay RM – frame stay, solid

- » Aluminum profile bars for heavy loads and maximum cable carrier widths. Double threaded joint on both sides “Heavy Duty”.
- » Available customized in **1 mm grid**.
- » **Inside/outside:** Threaded joints easy to release.

HEAVY DUTY
TSUBAKI KABELSCHLEPP

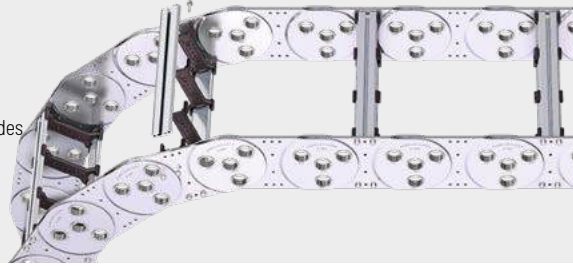

Stay arrangement on every
2nd chain link, standard
(HS: half-stayed)



Stay arrangement on each
chain link (VS: fully-stayed)



1 mm B_k from 250 – 1000 mm
in **1 mm width sections**

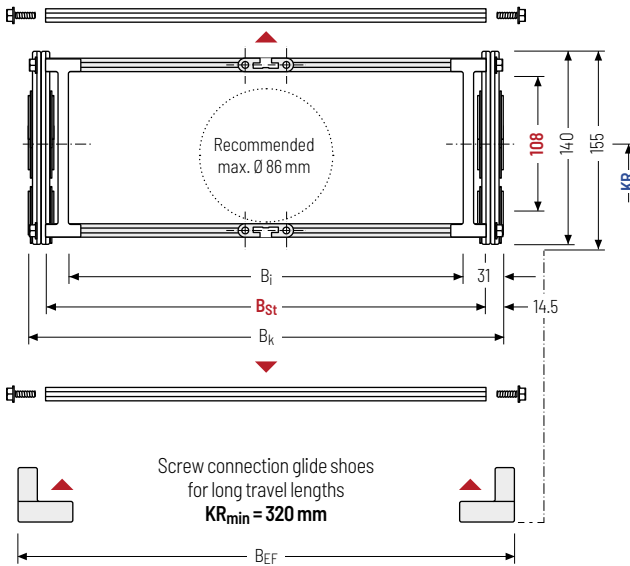

The maximum cable diameter strongly depends on the bending radius and the desired cable type. Please contact us.

Calculating the cable carrier length

Cable carrier length L_k

$$L_k \approx \frac{L_S}{2} + L_B$$

Cable carrier length L_k
rounded to pitch t

h _i [mm]	h _G [mm]	h _{G'} [mm]	B _i [mm]	B _{St} [mm]*	B _k [mm]	B _{EF} [mm]	KR [mm]			q _k [kg/m]
108	140	155	188	221	B _{St} + 29	B _{St} + 40	265	320	375	24.08
			938	971			605	720	890	

* in 1 mm width sections

Order example



SX1800

Type

417

B_{St}[mm]

RM

Stay variant

375

KR [mm]

St

Material

5940

L_k[mm]

HS

Stay arrangement

Divider systems

The divider system is mounted on each crossbar as a standard – on every 2nd chain link for stay mounting (HS).

As a standard, dividers or the complete divider system (dividers with height separations) are movable in the cross section (**version A**).

Divider system TSO without height separation

Vers.	a _T min [mm]	a _x min [mm]	a _c min [mm]	Π _T min
A	21.5	25	17.5	–

The dividers can be moved in the cross section.

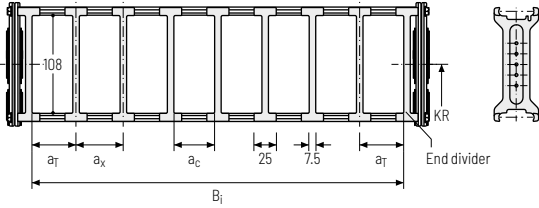

Divider system TS1 with continuous height separation

Vers.	a _T min [mm]	a _x min [mm]	a _c min [mm]	Π _T min
A	21.5	25	17.5	2

The dividers can be moved in the cross section.

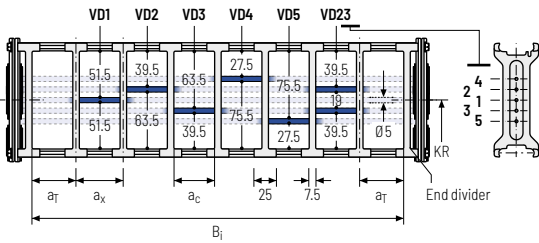

Divider system TS3 with height separation consisting of plastic partitions

Vers.	a _T min [mm]	a _x min [mm]	a _c min [mm]	Π _T min
A	11.5	16 / 42*	8	2

* For aluminum partitions

The dividers are fixed with the partitions. The entire divider system can be moved in the cross section.

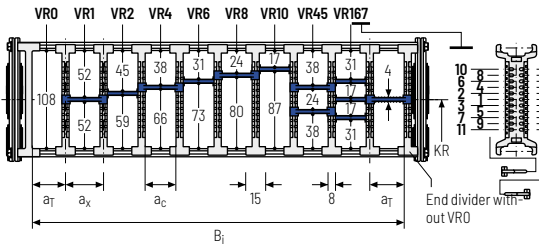

Aluminum partitions in 1 mm width increments with a_x > 42 mm are also available.

a _x (center distance of dividers) [mm]											
a _c (nominal width of inner chamber) [mm]											
16	18	23	28	32	33	38	43	48	58	64	68
8	10	15	20	24	25	30	35	40	50	56	60
78	80	88	96	112	128	144	160	176	192	208	
70	72	80	88	104	120	136	152	168	184	200	

When using plastic partitions with a_x > 112 mm, we recommend an additional center support with a twin divider (S_T = 4 mm). Twin dividers are also suitable for retrofitting in the partition system.

MT series
XLT series
ROBOTRAX® System
FLATVEVOR®
CLEANVEVOR®
LS/LSX series
S/SX series
S/SX-Tubes series
Accessories
TRAXLINE®

Tube stay RR – frame stay, tube version

- » Steel rolling stays with gentle cable support and steel dividers. Ideal for using media hoses with soft sheathing. Easy screw connection.
- » Available customized in **1 mm width sections**.
- » **Inside/outside:** Screw connection detachable
- » **Option:** Divider systems made from stainless steel ER 1, ER 1S.

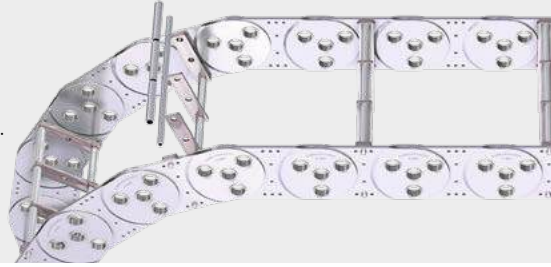

Stay arrangement on every 2nd chain link, standard
(HS: half-stayed)



Stay arrangement on each chain link **(VS: fully-stayed)**



1 mm B_k from 250 – 800 mm
in **1 mm width sections**

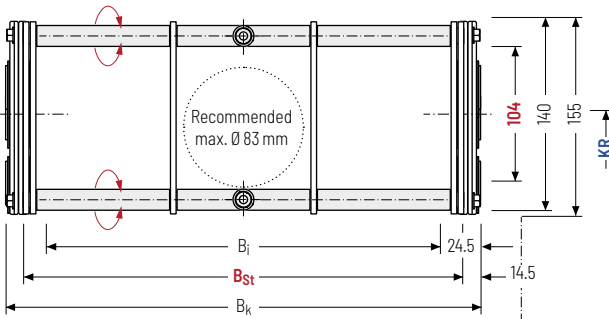

The maximum cable diameter strongly depends on the bending radius and the desired cable type. Please contact us.

Calculating the cable carrier length

Cable carrier length L_k

$$L_k \approx \frac{L_S}{2} + L_B$$

Cable carrier length L_k
rounded to pitch t

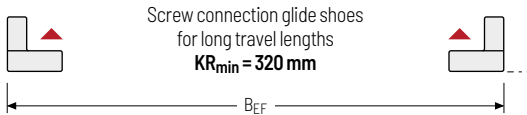

h _i [mm]	h _G [mm]	h _{G'} [mm]	B _i [mm]	B _{St} [mm]*	B _k [mm]	B _{EF} [mm]	KR [mm]					q _k [kg/m]
104	140	155	201 751	221 771	B _{St} + 29	B _{St} + 40	265	320	375	435	490	26.57
							605	720	890	1175	1300	

* in 1 mm width sections

Order example



S1800

Type

417

B_{St} [mm]

RR

Stay variant

375

KR [mm]

St

Material

5940

L_k [mm]

HS

Stay arrangement

Divider systems

As a standard, the divider system is mounted on each crossbar – for stay mounting on every 2nd chain link (HS).

The dividers are fixed through the tubes. The tube additionally serves as a spacer between the dividers (**version B**).

Divider system TSO without height separation

Vers.	a _T min [mm]	a _x min [mm]	a _c min [mm]	n _T min
B	45	45	40	-

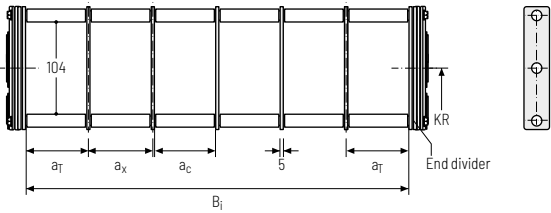

Divider system TS1 with continuous height separation

Vers.	a _T min [mm]	a _x min [mm]	a _c min [mm]	n _T min
B	45	45	40	2

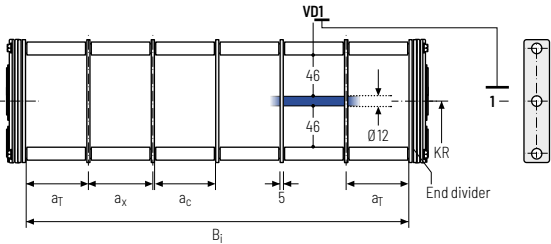

Order example

TS1	·	B	·	3	·	K1	·	34	-	VDD	
						⋮					
						⋮					
						⋮					
						K4			VDD		
Divider system		Version		n _T		Chamber		a _x		Height separation	

Please state the designation of the divider system (**TS0, TS1...**), version and number of dividers per cross section [n_T]. In addition, please also enter the chambers [K] from left to right, as well as the assembly distances [a_T/a_x] (as seen from the driver).

Subject to change without notice.

TRAXLINE® cables for cable carriers

Hi-flex electric cables which were especially developed, optimized and tested for use in cable carriers can be found at tsubaki-kabelschlepp.com/traxline

	MT series
	XLT series
	ROBOTRAX® System
	FLATVEVOR®
	CLEANVEVOR®
	LS/LSX series
	S/SX series
	S/SX-Tubes series
	Accessories
	TRAXLINE®

Aluminum stay LG - hole stay, split version

- » Optimum cable routing in the neutral bending line. Split version for easy cable routing. Stays also available unsplit.
- » Available customized in **1 mm grid**.
- » **Inside/outside:** Threaded joint easy to release.

HEAVY DUTY
TSUBAKI KABELSCHLEPP



Stay arrangement on every
2nd chain link standard
(HS: half-stayed)



Stay arrangement on each
chain link **(VS: fully-stayed)**



1mm B_i 180 - 1000 mm
in **1 mm width sections**

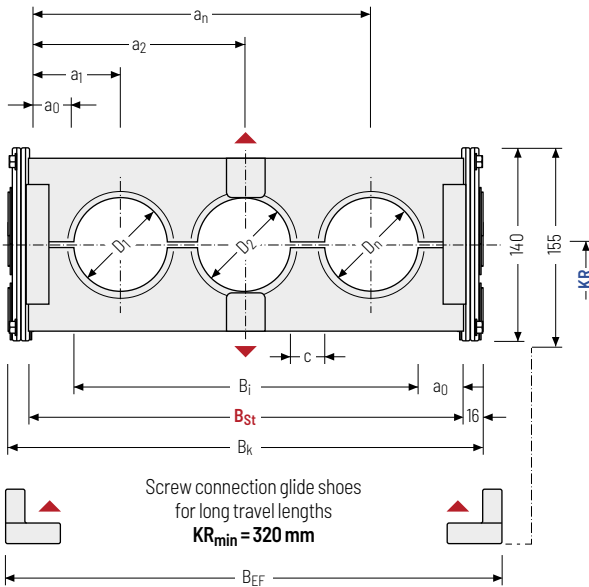

The maximum cable diameter strongly depends on the bending radius and the desired cable type. Please contact us.

Calculating the cable carrier length

Cable carrier length L_k

$$L_k \approx \frac{L_S}{2} + L_B$$

Cable carrier length L_k
rounded to pitch t

Calculating the stay width

Stay width B_{St}

$$B_{St} = \sum D + \sum c + 2 a_0$$

D _{max} [mm]	D _{min} [mm]	h _G [mm]	h _{G'} [mm]	B _i [mm]	B _{St} [mm]*	B _k [mm]	B _{EF} [mm]	c _{min} [mm]	a _{0 min} [mm]	KR [mm]				q _k 50%** [kg/m]
110	12	140	155	121	148	B _{St}	B _{St}	4	13.5	265	320	375	435	24,38
				-	-	+	+			490	605	720	890	-
				941	968	32	43			1175	1300			35,08

* in 1 mm width sections ** Hole ratio of the hole stay approx. 50 %

Order example



S1800

Type

417

B_{St} [mm]

LG

Stay variant

375

KR [mm]

St

Material

5940

L_k [mm]

HS

Stay arrangement



MT
series

XLT
series

ROBOTRAX®
System

FLATVEVOR®

CLEANVEVOR®

LS/LSX
series

S/SX
series

S/SX-Tubes
series

Accessories

TRAXLINE®

End connectors - steel

End connectors made of steel. The connection variants on the fixed point and on the driver can be combined and changed later on, if necessary.

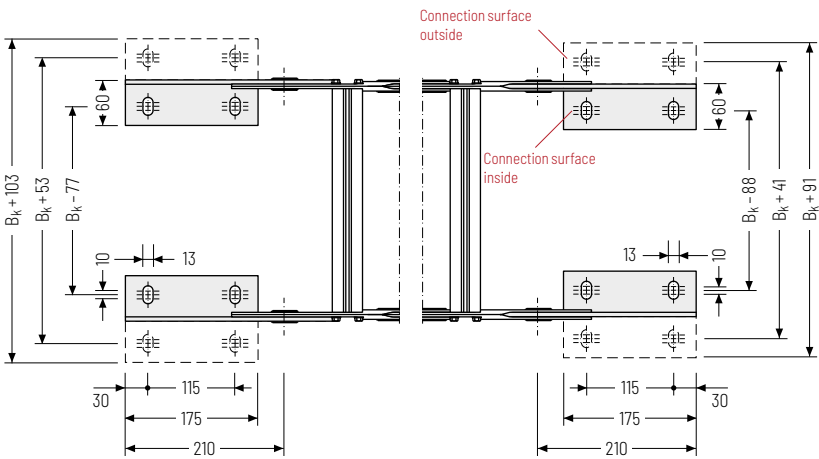
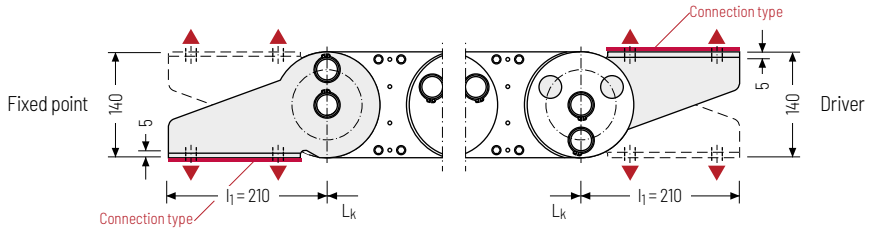

▲ Assembly options

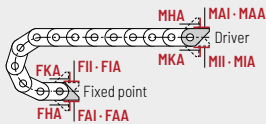

Connection point

F - fixed point
M - driver

Connection type

A - threaded joint to outside (standard)
I - threaded joint to inside
H - threaded joint, rotated 90° to the outside
K - threaded joint, rotated 90° to the inside

Connection surface

I - connection surface inside (standard)
A - connection surface outside

Caution: The standard connection variant FAI/MAI is only possible from B_k of 139 mm.

Order example



Steel	F	A	I
Steel	M	A	I
End connector	Connection point	Connection type	Connection surface



We recommend the use of strain reliefs at the driver and fixed point. See from p. 904.

Special designs

S/SX1802 – with closed stroke system and straight link plates



- » Closed stroke system protected between link plates mounted on both sides.
- » Symmetrical side band design.
- » Long service life even under the toughest conditions, e.g. large amounts of foundry sand, emery or scale thanks to optimized cable carrier geometry.

S/SX1802 B – with internal stroke system and straight link plates

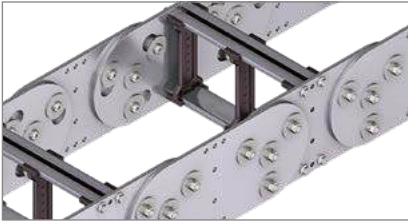

- » Open stroke system.
- » Link plates of the side bands are mounted offset.
- » Long service life even under the toughest conditions, e.g. large amounts of foundry sand, emery or scale thanks to optimized cable carrier geometry.
- » The optimized, "self-cleaning" geometry prevents blocking of the stops through dirt.
- » Version with bolted side bands.

MT series

XLT series

ROBOTRAX® System

FLATVEYOR®

CLEANVEYOR®

LS/LSX series

S/SX series

S/SX-Tubes series

Accessories

TRAXLINE®



TOTALTRAX® complete systems

Benefit from the advantages of a TOTALTRAX complete system. A complete delivery from one source – with a warranty certificate on request! Learn more at tsubaki-kabelschlepp.com/totaltrax

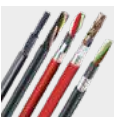

TRAXLINE® cables for cable carriers

Hi-flex electric cables which were especially developed, optimized and tested for use in cable carriers can be found at tsubaki-kabelschlepp.com/traxline

S/SX2500

MT
seriesXLT
seriesROBOTRAX®
System

FLATVEYOR®

CLEANVEYOR®

LS/LSX
seriesS/SX
seriesS/SX-Tubes
series

Accessories

TRAXLINE®



Pitch
250 mm



Inner height
180 - 183 mm



Chain widths
250 - 1200 mm



Bending radii
365 - 1395 mm

Stay variants



Aluminum stay RM..... page **756**

Frame stay, solid

- » Aluminum profile bars for heavy loads and maximum cable carrier widths. Double threaded joint on both sides "**Heavy Duty**".
- » **Inside/outside:** Threaded joint easy to release.



Aluminum stay LG..... page **758**

Frame stay, split

- » Optimum cable routing in the neutral bending line. Split version for easy cable routing.
- » **Inside/outside:** Threaded joint easy to release.



Steel band cover

Also available as covered variants with steel band cover. More information can be found in chapter "steel band cover" from p. 916.

Unsupported arrangement

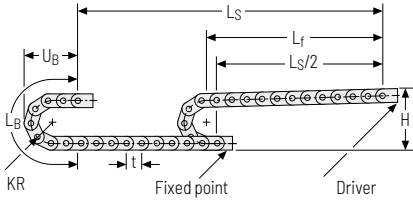

KR [mm]	H [mm]	LB [mm]	UB [mm]
365	1060	2147	975
445	1220	2398	1055
600	1530	2885	1210
760	1850	3388	1370
920	2170	3890	1530
1075	2480	4377	1685
1235	2800	4880	1845
1395	3120	5383	2005

Installation height H_z

$H_z = H + 10 \text{ mm/m}$

Load diagram for unsupported length depending on the additional load.

Intrinsic cable carrier weight $q_k = 41 \text{ kg/m}$. For other inner widths, the maximum additional load changes.

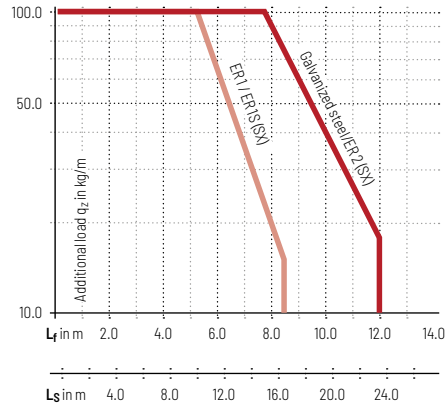

Speed
up to 1 m/s

Acceleration
up to 3 m/s²

Travel length
up to 23.7 m

Additional load
up to 100 kg/m

MT series
XLT series
ROBOTRAX® System
FLATVEYOR®
CLEANVEYOR®
LS/LSX series
S/SX series
S/SX-Tubes series
Accessories
TRAXLINE®

Aluminum stay RM – frame stay, solid

- ▶ Aluminum profile bars for heavy loads and maximum cable carrier widths. Double threaded joint on both sides "Heavy Duty".
- ▶ Available customized in **1 mm grid**.
- ▶ **Inside/outside:** Threaded joint easy to release.

HEAVY DUTY
TSUBAKI KABELSCHLEPP



Stay arrangement on every
2nd chain link, standard
(HS: half-stayed)



Stay arrangement on each
chain link (VS: fully-stayed)



1 mm B_i 250 – 1200 mm
in **1 mm** width sections

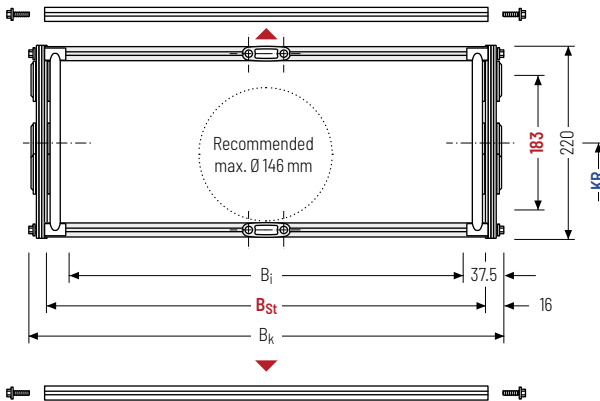

The maximum cable diameter strongly depends on the bending radius and the desired cable type. Please contact us.

Calculating the cable carrier length

Cable carrier length L_k

$$L_k \approx \frac{L_S}{2} + L_B$$

Cable carrier length L_k
rounded to pitch t for odd
number of chain links

h _i [mm]	h _G [mm]	B _i [mm]	B _{St} [mm]*	B _k [mm]	KR [mm]				q _k [kg/m]
183	220	175 1125	218 1168	B _{St} + 32	365 920	445 1075	600 1235	760 1395	38.68 44.58

* in 1 mm width sections

Order example



S2500

Type

806

B_{St}[mm]

RM

Stay variant

760

KR [mm]

St

Material

9250

L_k[mm]

HS

Stay arrangement

Divider systems

As a standard, the divider system is mounted on each crossbar - for stay mounting on every 2nd chain link (HS).

As a standard, dividers and the complete divider system (dividers with height separations) can be moved in the cross section (**version A**).

Divider system TSO without height separation

Vers.	a _T min [mm]	a _x min [mm]	a _c min [mm]	nr min
A	19	25	13	-

The dividers can be moved in the cross section.

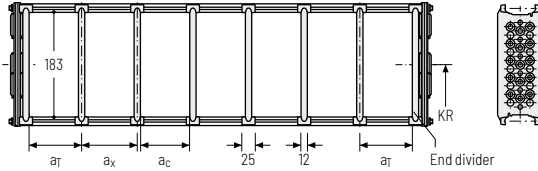

Divider system TS1 with continuous height separation

Vers.	a _T min [mm]	a _c min [mm]	a _x min [mm]	nr min
A	19	13	25	2

The dividers can be moved in the cross section.

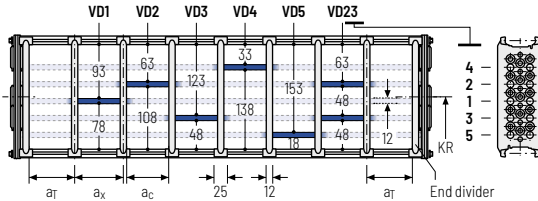

Divider system TS2 with partial height separation

Vers.	a _T min [mm]	a _x min [mm]	a _c min [mm]	nr min
A	40	46	34	2

Standard height separation with tube Ø 16 mm. The dividers can be moved in the cross section.

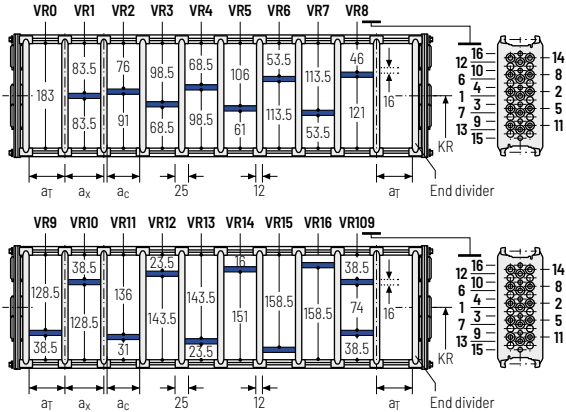

Order example



TS2	A	2	K1	34	VR1
			:	:	:
			K3	38	VR3
Divider system	Version	nr	Chamber	a _x	Height separation

MT series
XLT series
ROBOTRAX® System
FLATVEVOR®
CLEANVEVOR®
LS/LSX series
S/SX series
S/SX-Tubes series
Accessories
TRAXLINE®

Aluminum stay LG - hole stay, split version

- » Optimum cable routing in the neutral bending line. Split version for easy cable routing.
- » Available customized in **1 mm grid**.
- » **Inside/outside:** Threaded joint easy to release.

HEAVY DUTY
TSUBAKI KABELSCHLEPP

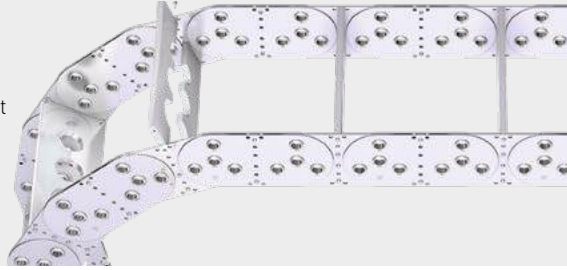

Stay arrangement on every
2nd chain link standard
(HS: half-stayed)



Stay arrangement on each
chain link (VS: fully-stayed)



1mm B_i 250 – 1200 mm
in **1 mm width sections**

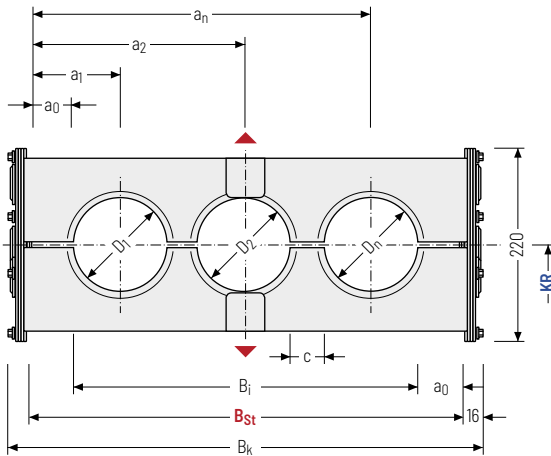

The maximum cable diameter strongly depends on the bending radius and the desired cable type. Please contact us.

Calculating the cable carrier length

Cable carrier length L_k

$$L_k \approx \frac{L_S}{2} + L_B$$

Cable carrier length L_k
rounded to pitch t for odd
number of chain links

Calculating the stay width

Stay width B_{St}

$$B_{St} = \sum D + \sum c + 2 a_0$$

D_{max} [mm]	D_{min} [mm]	h_g [mm]	B_i [mm]	B_{St} [mm]*	B_k [mm]	c_{min} [mm]	a_0_{min} [mm]	KR [mm]				q_k 50%** [kg/m]
180	12	220	174 1124	218 1168	$B_{St} + 32$	4	22	365 920	445 1075	600 1235	760 1395	36.66 48.36

* in 1 mm width sections ** Hole ratio of the hole stay approx. 50 %

Order example



SX2500

Type

806

B_{St} [mm]

LG

Stay variant

760

KR [mm]

St

Material

9250

L_k [mm]

HS

Stay arrangement

End connectors - steel

End connectors made of steel. The connection variants on the fixed point and on the driver can be combined and, if required, changed afterwards.

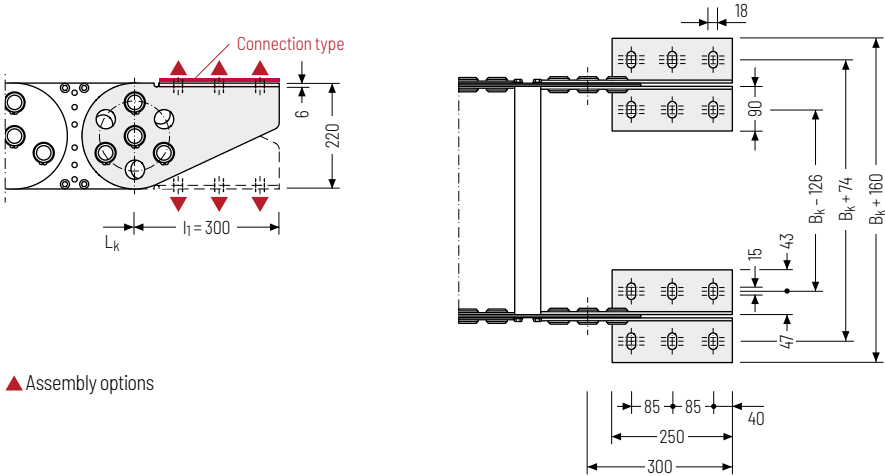

▲ Assembly options

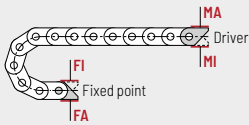

Connection point

- F - fixed point
- M - driver

Connection type

- A - threaded joint outside (standard)
- I - threaded joint inside

Order example

	Steel	F	A
	Steel	M	A
	End connector	Connection point	Connection type

We recommend the use of strain reliefs at the driver and fixed point. See from p. 904.

More product information online



Assembly instructions etc.: Additional info via your smartphone or check online at tsubaki-kabelschlepp.com/downloads



Configure your custom cable carrier here: online-engineer.de

MT series
XLT series
ROBOTRAX® System
FLATVEYOR®
CLEANVEYOR®
LS/LSX series
S/SX series
S/SX-Tubes series
Accessories
TRAXLINE®

S/SX3200



Pitch
320 mm



Inner height
220 mm



Chain widths
250 - 1500 mm



Bending radii
470 - 1785 mm

Stay variants



Aluminum stay LG page **762**

Frame stay, split

- » Optimum cable routing in the neutral bending line. Split version for easy cable routing.
- » **Inside/outside:** Threaded joint easy to release.



Stay variant RR available as a customized design.
Please contact us.



TOTALTRAX® complete systems

Benefit from the advantages of the TOTALTRAX® complete system. A complete delivery from one source - with a warranty certificate on request! Learn more at tsubaki-kabelschlepp.com/totaltrax

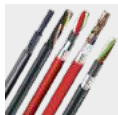

TRAXLINE® cables for cable carriers

Hi-flex electric cables which were especially developed, optimized and tested for use in cable carriers can be found at tsubaki-kabelschlepp.com/traxline

Unsupported arrangement

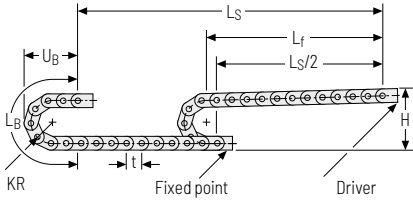

KR [mm]	H [mm]	L _B [mm]	U _B [mm]
470	1390	2757	1260
670	1790	3385	1460
870	2190	4013	1660
1075	2600	4657	1865
1275	3000	5286	2065
1480	3410	5930	2270
1785	4020	6888	2575

Installation height H_z

$H_z = H + 10 \text{ mm/m}$

Load diagram for unsupported length depending on the additional load.

Intrinsic cable carrier weight $q_k = 41 \text{ kg/m}$. For other inner widths, the maximum additional load changes.

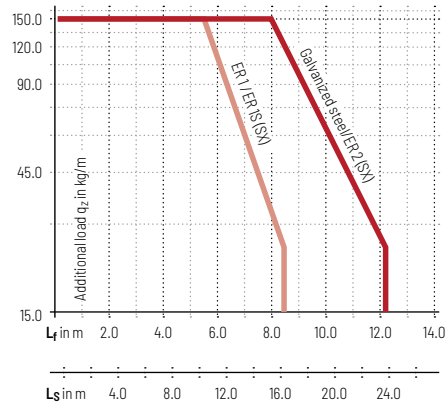

Speed
up to 1 m/s

Acceleration
up to 2.5 m/s²

Travel length
up to 24 m

Additional load
up to 150 kg/m

More product information online



Assembly instructions etc.:
Additional info via your
smartphone or check online at
[tsubaki-kabelschlepp.com/
downloads](http://tsubaki-kabelschlepp.com/downloads)



Configure your custom
cable carrier here:
online-engineer.de

Aluminum stay LG - hole stay, split version

- » Optimum cable routing in the neutral bending line. Split version for easy cable routing.
- » Available customized in **1 mm grid**.
- » **Inside/outside:** Threaded joint easy to release.

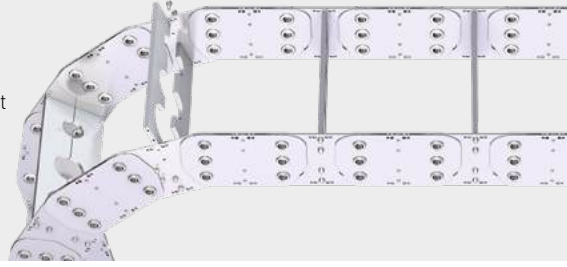

HEAVY DUTY
TSUBAKI KABELSCHLEPP



Stay arrangement on every 2nd chain link, standard
(HS: half-stayed)



Stay arrangement on each chain link **(VS: fully-stayed)**



1 mm B_i 250 – 1500 mm
in **1 mm width sections**

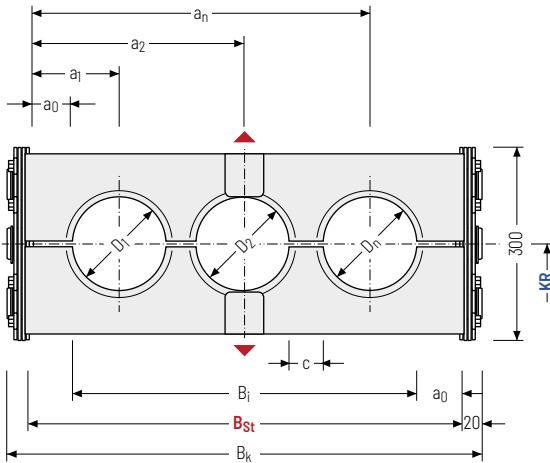

The maximum cable diameter strongly depends on the bending radius and the desired cable type. Please contact us.

Calculating the cable carrier length

Cable carrier length L_k

$$L_k \approx \frac{L_S}{2} + L_B$$

Cable carrier length L_k rounded to pitch t for odd number of chain links

Calculating the stay width

Stay width B_{St}

$$B_{St} = \sum D + \sum c + 2 a_0$$

D _{max} [mm]	D _{min} [mm]	h _G [mm]	B _i [mm]	B _{St} [mm]*	B _k [mm]	c _{min} [mm]	a _{0 min} [mm]	KR [mm]				q _{k 50 %**} [kg/m]
220	12	300	181	225 - 1460	B _{St} + 40	4	22	470	670	870	1075	57.48
			1275					1480	1785	72.66		

* in 1 mm width sections

** Hole ratio of the hole stay approx. 50 %

Order example



SX3200

Type

776

B_{St}[mm]

LG

Stay variant

1075

KR [mm]

ER 1

Material

9280

L_k [mm]

HS

Stay arrangement

End connectors – steel

End connectors made of steel. The connection variants on the fixed point and on the driver can be combined and, if required, changed afterwards.

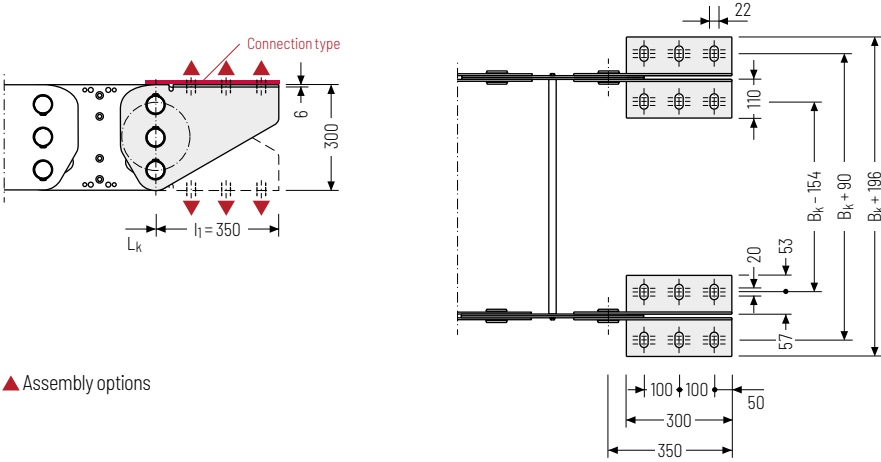

▲ Assembly options

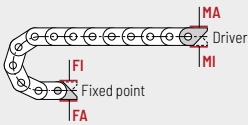

Connection point

- F – fixed point
- M – driver

Connection type

- A – threaded joint outside (standard)
- I – threaded joint inside

Order example



Steel	F	A
Steel	M	A
End connector	Connection point	Connection type



We recommend the use of strain reliefs at the driver and fixed point. See from p. 904.

More product information online



Assembly instructions etc.: Additional info via your smartphone or check online at tsubaki-kabelschlepp.com/downloads



Configure your custom cable carrier here: online-engineer.de

MT series
XLT series
ROBOTRAX® System
FLATVEYOR®
CLEANVEYOR®
LS/LSX series
S/SX series
S/SX-Tubes series
Accessories
TRAXLINE®

S/SX

5000 – 8000



Pitch
200 – 550 mm



Inner heights
150 – 578 mm



Chain widths
250 – 1800 mm



Bending radii
min. 500 mm

Stay variants



Steel stay special design..... from page 766

Steel frame stay, bolted

- » Steel profile bars for extremely high additional loads and very large cable carrier widths. Double threaded joint on both sides.
- » **Inside/outside:** Threaded joint can be released.



Cable carriers of types 5000 – 8000 are **customized products** for special applications, e.g. offshore use.



TOTALTRAX® complete systems

Benefit from the advantages of the TOTALTRAX® complete system. A complete delivery from one source – with a warranty certificate on request! Learn more at tsubaki-kabelschlepp.com/totaltrax

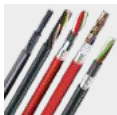

TRAXLINE® cables for cable carriers

Hi-flex electric cables which were especially developed, optimized and tested for use in cable carriers can be found at tsubaki-kabelschlepp.com/traxline

Unsupported arrangement

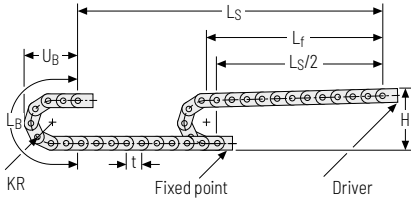

Installation height H_z

$$H_z = H + 10 \text{ mm/m}$$

Load diagram for unsupported length depending on the additional load.

Intrinsic cable carrier weight q_k

50 kg/m for S/SX5000

75 kg/m for S/SX6000

150 kg/m for S/SX7000

230 kg/m for S/SX8000

For other inner widths, the maximum additional load changes.

Type	KR [mm]	H [mm]	L _B [mm]	U _B [mm]
S/SX5000	min. 500	1200	1970	800
	max. 1200	2600	4170	1500
S/SX6000	min. 700	1700	2840	1170
	max. 1500	3300	5350	1970
S/SX7000	min. 900	2250	3725	1575
	max. 2400	5250	8435	3075
S/SX8000	min. 900	2400	3925	1750
	max. 2400	5400	8635	3250

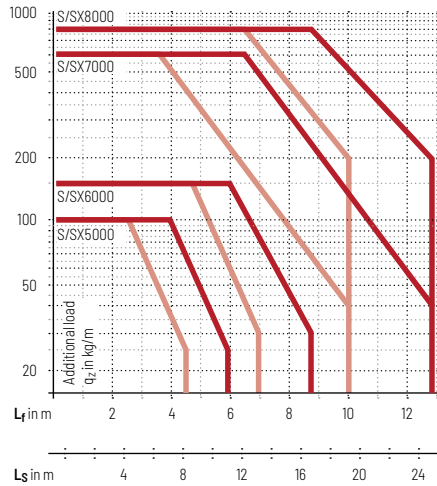

— S5000/6.../7.../8... galvanized steel
— SX5000/6.../7.../8... ER2
— SX5000/6.../7.../8... ER1/ER1S



Speed

S/SX5000 up to 2.0 m/s

S/SX6000 up to 1.5 m/s

S/SX7000 up to 0.5 m/s

S/SX8000 up to 0.5 m/s



Acceleration

S/SX5000 up to 3.0 m/s²

S/SX6000 up to 2.0 m/s²

S/SX7000 up to 0.3 m/s²

S/SX8000 up to 0.3 m/s²



Travel length

S/SX5000 up to 11.0 m

S/SX6000 up to 16.7 m

S/SX7000 up to 24.9 m

S/SX8000 up to 24.9 m



Additional load

S/SX5000 up to 100 kg/m

S/SX6000 up to 150 kg/m

S/SX7000 up to 600 kg/m

S/SX8000 up to 800 kg/m

More product information online



Assembly instructions etc.:
Additional info via your
smartphone or check online at
[tsubaki-kabelschlepp.com/
downloads](http://tsubaki-kabelschlepp.com/downloads)



Configure your custom
cable carrier here:
online-engineer.de

Steel stay - steel frame stay, bolted

- » Steel profile bars for extremely high additional loads and very large cable carrier widths.
- » Double threaded joint on both sides.
- » Available customized in **1 mm grid**.
- » **Inside/outside:** Threaded joint can be released.

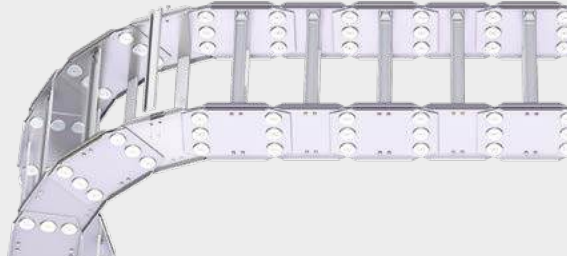

Stay arrangement on each chain link (**VS: fully-stayed**)



1 mm B_i: 250 - 1200 mm
in 1 mm width sections

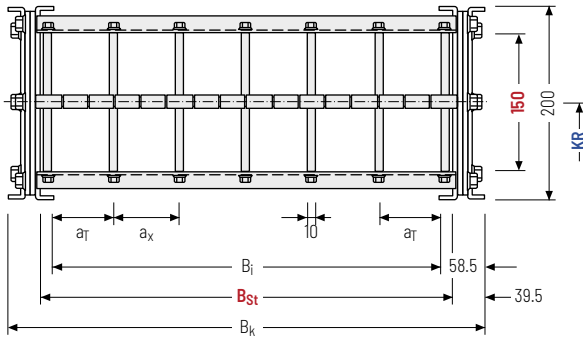

The maximum cable diameter strongly depends on the bending radius and the desired cable type. Please contact us.

Calculating the cable carrier length

Cable carrier length L_k

$$L_k \approx \frac{L_S}{2} + L_B$$

Cable carrier length L_k rounded to pitch t for odd number of chain links

h_i [mm]	h_G [mm]	B_i [mm]	B_{St} [mm]*	B_k [mm]	a_T max [mm]	a_x max [mm]	n_T min	KR [mm]**	q_k [kg/m]
150	200	133 1083	171 1121	$B_{St} + 79$	150	150	2	500 1200	42.5 52.0

* in 1 mm width sections

** individual intermediate sizes available

MT
seriesXLT
seriesROBOTRAX®
System

FLATVEYOR®

CLEANVEYOR®

LS/SX
seriesS/SX
seriesS/SX-Tubes
series

Accessories

TRAXLINE®

Steel stay - steel frame stay, bolted

- » Steel profile bars for extremely high additional loads and very large cable carrier widths.
Double threaded joint on both sides.
- » Available customized in **1 mm grid**.
- » **Inside/outside:** Threaded joint can be released.

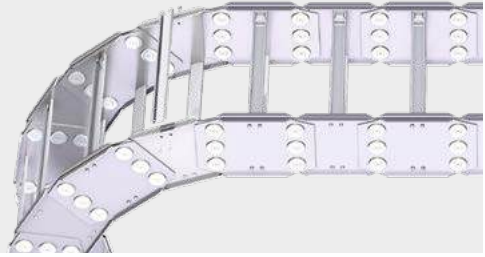

Stay arrangement on each chain link (VS: fully-stayed)



1mm B_i 300 - 1500 mm in 1 mm width sections

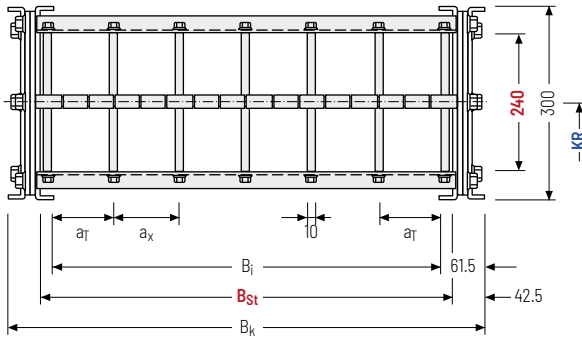

The maximum cable diameter strongly depends on the bending radius and the desired cable type. Please contact us.

Calculating the cable carrier length

Cable carrier length L_k

$$L_k \approx \frac{L_S}{2} + L_B$$

Cable carrier length L_k rounded to pitch t for odd number of chain links

h_i [mm]	h_G [mm]	B_i [mm]	B_{St} [mm]*	B_k [mm]	a_T max [mm]	a_x max [mm]	nT min	KR [mm]**	q_k [kg/m]
240	300	177 - 1377	215 - 1415	$B_{St} + 85$	200	200	2	700 - 1500	55 - 79

* in 1 mm width sections

** individual intermediate sizes available

Steel stay - steel frame stay, bolted

- » Steel profile bars for extremely high additional loads and very large cable carrier widths.
- » Double threaded joint on both sides.
- » Available customized in **1 mm grid**.
- » **Inside/outside:** Threaded joint can be released.

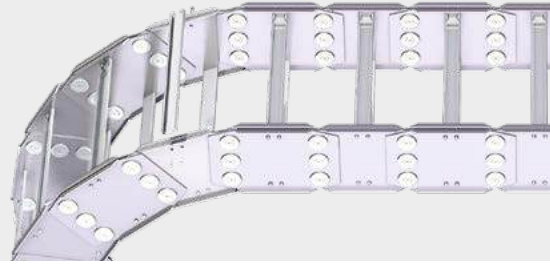

Stay arrangement on each chain link (**VS: fully-stayed**)



1 mm B_k from 350 - 1800 mm
in 1 mm width sections

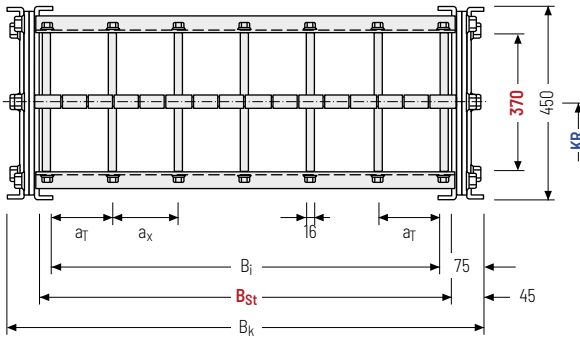

The maximum cable diameter strongly depends on the bending radius and the desired cable type. Please contact us.

Calculating the cable carrier length

Cable carrier length L_k

$$L_k \approx \frac{L_S}{2} + L_B$$

Cable carrier length L_k
rounded to pitch t for odd
number of chain links

h _i [mm]	h _G [mm]	B _i [mm]	B _{St} [mm]*	B _k [mm]	a _T max [mm]	a _X max [mm]	n _T min	KR [mm]**	q _k [kg/m]
370	450	200 - 1650	260 - 1710	B _{St} + 90	250	250	2	900 - 2400	135 - 164

* in 1 mm width sections

** individual intermediate sizes available

MT
seriesXLT
seriesROBOTRAX®
System

FLATVEYOR®

CLEANVEYOR®

LS/SX
seriesS/SX
seriesS/SX-Tubes
series

Accessories

TRAXLINE®

Steel stay - steel frame stay, bolted

- » Steel profile bars for extremely high additional loads and very large cable carrier widths.
- » Double threaded joint on both sides.
- » Available customized in **1 mm grid**.
- » **Inside/outside:** Threaded joint can be released.

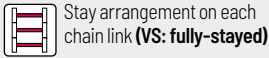
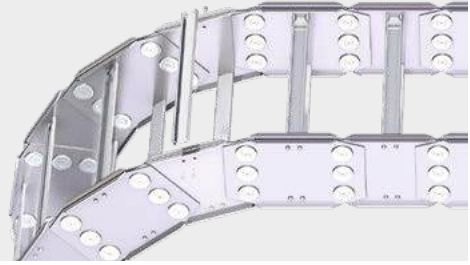

Stay arrangement on each chain link (**VS: fully-stayed**)



1mm B_i 350 - 1800 mm
in 1 mm width sections

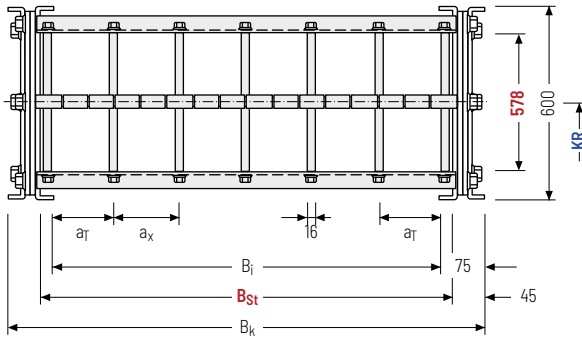

The maximum cable diameter strongly depends on the bending radius and the desired cable type. Please contact us.

Calculating the cable carrier length

Cable carrier length L_k

$$L_k \approx \frac{L_S}{2} + L_B$$

Cable carrier length L_k rounded to pitch t for odd number of chain links

h_i [mm]	h_G [mm]	B_i [mm]	B_{St} [mm]*	B_k [mm]	a_T max [mm]	a_x max [mm]	nT min	KR [mm]**	q_k [kg/m]
578	600	200 - 1650	260 - 1710	$B_{St} + 90$	300	300	2	900 - 2400	198 - 255

* in 1 mm width sections

** individual intermediate sizes available

End connectors - steel

End connectors made of steel. The connection variants on the fixed point and on the driver can be combined and, if required, changed afterwards.

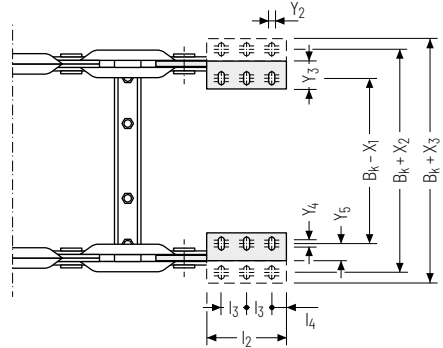
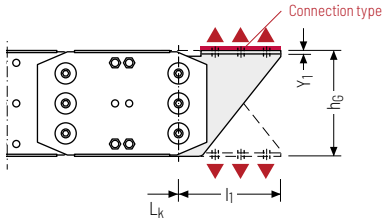

▲ Assembly options

Type	l ₁ [mm]	l ₂ [mm]	l ₃ [mm]	l ₄ [mm]	X ₁ [mm]	X ₂ [mm]	X ₃ [mm]	Y ₁ [mm]	Y ₂ [mm]	Y ₃ [mm]	Y ₄ [mm]	Y ₅ [mm]
S/SX5000	300	200	75	25	130	210	290	12	18	90	15	50
S/SX6000	400	300	100	50	130	210	290	12	18	90	15	50
S/SX7000	400	300	100	50	140	220	300	12	22	90	15	50
S/SX8000	400	300	100	50	140	220	300	12	22	90	15	50

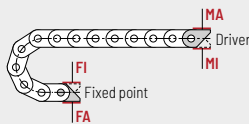

Connection point

F - fixed point
M - driver

Connection type

A - threaded joint outside (standard)
I - threaded joint inside

More product information online



Assembly instructions etc.:
Additional info via your
smartphone or check online at
[tsubaki-kabelschlepp.com/
downloads](http://tsubaki-kabelschlepp.com/downloads)



Configure your custom
cable carrier here:
online-engineer.de



Subject to change without notice.

MT series

XLT series

ROBOTRAX® System

FLATVEYOR®

CLEANVEYOR®

LS/LSX series

SYSX series

SYSX-Tubes series

Accessories

TRAXLINE®

S/SX9000

Custom sizes



**Cable carrier
width**
from 350 mm

For over 65 years, TSUBAKI KABELSCHLEPP has been developing and manufacturing steel cable carriers which are used in a great variety of applications, from steel works and shipbuilding to offshore oil rigs. We comply with the required quality and industry standards and are happy to develop customized solutions for your individual projects. We can manufacture special sizes in different materials as per your requirements.

- » Individual problem solutions from an experienced engineering team
- » Maintenance-free systems with a high level of reliability and availability
- » Different materials adapted to the area of application
- » Resistant to temperature, corrosion, chemicals and UV
- » Suitable for use with salt water
- » Explosion protection with classification EX II 2 GD as per ATEX RL
- » Linear and rotating travel paths possible
- » Easy and flexible assembly with modular design
- » Cable weights of over 1000 kg/m possible
- » Long service life



TSUBAKI KABELSCHLEPP technical support

If you have any questions about the configuration of cable carriers or other technical details please contact our technical support at technik@kabelschlepp.de. We will be happy to help you.





Subject to change without notice.

773

MT
series

XLT
series

ROBOTRAX®
System

FLATVEYOR®

CLEANVEYOR®

LS/LSX
series

S/SX
series

S/SX-Tubes
series

Accessories

TRAXLINE®

MT
seriesXLT
seriesROBOTRAX®
System

FLATVEYOR®

CLEANVEYOR®

LS/LSX
seriesS/SX
seriesS/SX-Tubes
series

Accessories

TRAXLINE®

TUBES-STEEL

Covered steel cable carriers for extreme applications

Special applications require the use of special cable carriers. Our steel and stainless steel cable carriers are the first choice for extreme heat or other very rough ambient conditions, such as in mining, smelting or oil production. Customized separating options offer best possible protection for cables and hoses even under high mechanical loads.

- » Robust design for high mechanical loads
- » High additional loads and extensive unsupported lengths possible
- » Ideal for extreme and rough ambient conditions
- » Heat-resistant



S/SX-TUBES series page 804
Extremely robust and sturdy covered steel cable carriers

MT series

XLT series

ROBOTRAX® System

FLATVEYOR®

CLEANVEYOR®

LS/LSX series

S/SX series

S/SX-Tubes series

Accessories

TRAXLINE®

S/SX Tubes series

Extremely robust and sturdy covered steel cable carriers



Trademarks are legally protected for the TSUBAKI KABELSCHLEPP GmbH as a national or international registration in the following countries: tsubaki-kabelschlepp.com/trademarks

Subject to change without notice.

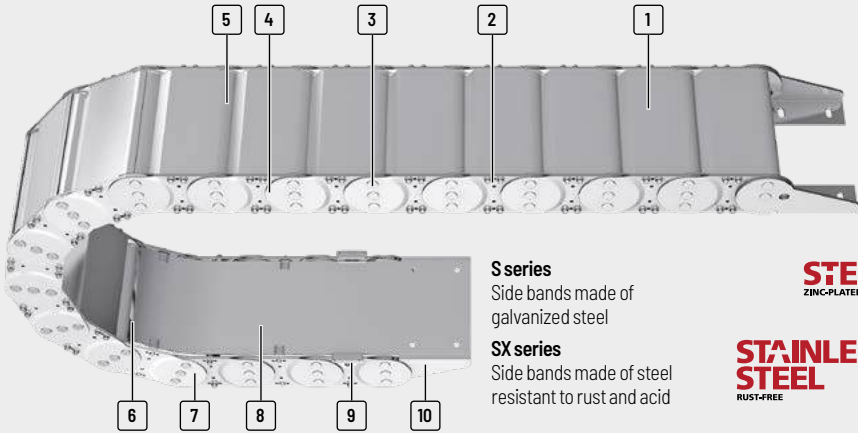

STEEL
ZINC-PLATED

STAINLESS STEEL
RUST-FREE

S series

Side bands made of galvanized steel

SX series

Side bands made of steel resistant to rust and acid

- 1 Aluminum covers available in **1 mm width sections**
- 2 4 bolted aluminum covers for extreme loads
- 3 Joint design with hardened bolts for long service life
- 4 Cranked link plate design
- 5 Can be opened on the inside and the outside for cable laying
- 6 Different separation options for the cables
- 7 Extremely robust side bands, galvanized or stainless steel
- 8 Steel band cover available in **1 mm width sections**
- 9 Replaceable glide shoes
- 10 End connectors for different connection variants

Features

- » Extremely robust, sturdy steel cable carriers for heavy mechanical loads and rough environmental conditions
- » Side bands made of galvanized steel (S series) or corrosion-resistant and acid-resistant steel (SX series) in three qualities: ER 1 / ER 1S and ER 2
- » Very sturdy link plates, each consisting of two individual plates
- » Very extensive unsupported lengths even with large additional loads
- » Joint design with multi stroke system and hardened bolt
- » Bolted stay systems, solid end connectors
- » Explosion protection with classification EX II 2 GD as per ATEX RL

The design

Proven steel cable carriers with extremely sturdy link plates and dedicated joint design with multi stroke system and hardened bolt. The extremely sturdy design allows extensive unsupported lengths and high possible additional loads.

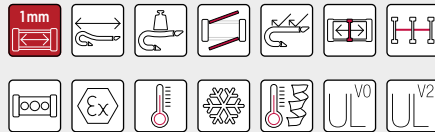

Sandwich design:
Link plates consist of two plates



Glide shoes available for gliding applications



Stroke system with hardened bolt and circlips



Also available as open variants with different stay variants, p. 718

Type	Opening variant	Stay variant	h_i [mm]	h_G [mm]	B_i [mm]	B_k [mm]	B_i - grid [mm]	t [mm]	KR [mm]	Additional load \leq [kg/m]	Cable- d_{max} [mm]

S/SX0650 Tubes



RMD

30

50

65 - 465

100 - 500

1

65

115 - 400

30

24

S/SX0950 Tubes



RMD

44

68

88 - 563

125 - 600

1

95

170 - 600

45

35

S/SX1250 Tubes



RMD

69

94

101 - 751

150 - 800

1

125

200 - 1000

50

55

S/SX1800 Tubes



RMD

104

140

188 - 938

250 - 1000

1

180

320 - 1300

60

83

* Depending on the specific application, additional gliding elements or rollers are required.

** Application-specific, values on request.

Unsupported arrangement			Gliding arrangement			Inner Distribution				Movement			Page
Travel length ≤ [m]	$v_{max} \leq [m/s]$	$a_{max} \leq [m/s^2]$	Travel length ≤ [m]	$v_{max} \leq [m/s]$	$a_{max} \leq [m/s^2]$	TS0	TS1	TS2	TS3	vertical hanging or standing	lying on the side	rotating arrangement	

5.8	2.5	5	**	1	2	•	•	-	-	•	•	-	782
-----	-----	---	----	---	---	---	---	---	---	---	---	---	-----

8.8	2.5	5	**	1	2	•	•	-	-	•	•	-	788
-----	-----	---	----	---	---	---	---	---	---	---	---	---	-----

13.5	2.5	5	**	1	2	•	•	•	-	•	•	-	794
------	-----	---	----	---	---	---	---	---	---	---	---	---	-----

17.8	2	3	**	0.8	2	•	•	-	•	•	•	-	798
------	---	---	----	-----	---	---	---	---	---	---	---	---	-----

MT series

XLT series

ROBOTRAX® System

FLATVEVOR®

CLEANVEVOR®

LS/LSX series

S/SX series

S/SX-Tubes series

Accessories

TRAXLINE®

S/SX0650



Pitch
65 mm



Inner height
30 mm



Chain widths
100 – 500 mm



Bending radii
115 – 300 mm

Stay variants



Aluminum stay RMD page **782**

Aluminum cover system

- » Bolted aluminum covers for maximum stability.
- » For applications generating chips or coarse contamination.
- » **Inside/outside:** Threaded joint easy to release.



TOTALTRAX® complete systems

Benefit from the advantages of the TOTALTRAX® complete system. A complete delivery from one source – with a warranty certificate on request! Learn more at tsubaki-kabelschlepp.com/totaltrax



TRAXLINE® cables for cable carriers

Hi-flex electric cables which were especially developed, optimized and tested for use in cable carriers can be found at tsubaki-kabelschlepp.com/traxline

Unsupported arrangement

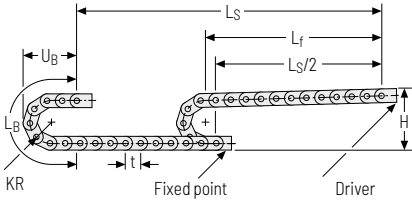

Installation height H_2

$H_2 = H + 10 \text{ mm/m}$

Load diagram for unsupported length depending on the additional load.

Intrinsic cable carrier weight $q_k = 4.5 \text{ kg/m}$. For other inner widths, the maximum additional load changes.

For cable carriers with a aluminum cover system, a higher intrinsic cable carrier weight is to note.

KR [mm]	H [mm]	L _B [mm]	U _B [mm]
115	305	621	270
125	325	653	280
135	345	684	290
145	365	716	300
155	385	747	310
175	425	810	330
200	475	888	355
250	575	1045	405
300	675	1202	455
400	875	1516	555

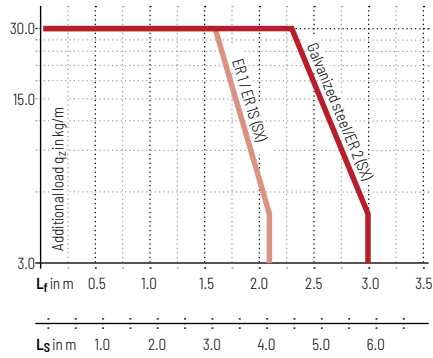

Speed
up to 2.5 m/s

Acceleration
up to 5 m/s²

Travel length
up to 5.8 m

Additional load
up to 30 kg/m

Gliding arrangement

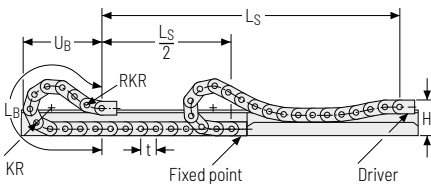

Speed
up to 1 m/s

Acceleration
up to 2 m/s²

Travel length
on request

Additional load
up to 30 kg/m

The gliding cable carrier must be guided in a channel. See p. 844.

Glide shoes have to be used for gliding applications.

Aluminum stay RMD – aluminum cover system

- » Bolted aluminum covers for maximum stability.
- » For applications generating chips or coarse contamination.
- » Available customized in **1 mm grid**.
- » **Inside/outside:** Threaded joint easy to release.



Stay arrangement on each chain link (**VS: fully-stayed**)



1 mm B_k 100 – 500 mm
in 1 mm width sections

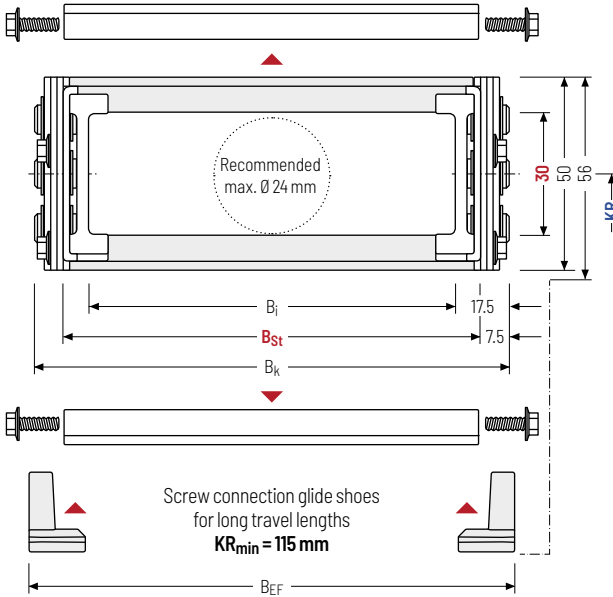

The maximum cable diameter strongly depends on the bending radius and the desired cable type. Please contact us.

Calculating the cable carrier length

Cable carrier length L_k

$$L_k \approx \frac{L_S}{2} + L_B$$

Cable carrier length L_k
rounded to pitch t

h _i [mm]	h _G [mm]	h _{G'} [mm]	B _i [mm]	B _{St} [mm]*	B _k [mm]	B _{EF} [mm]	KR [mm]					q _k [kg/m]
30	50	56	65	85	B _{St} + 15	B _{St} + 20	115	125	135	145	155	4.84
			465	485			175	200	250	300	400	10.50

* in 1 mm width sections

Order example



SX0650

Type

180

B_{St} [mm]

RMD

Stay variant

135

KR [mm]

St

Material

1430

L_k [mm]

VS

Stay arrangement

Divider systems

As a standard, the divider system is mounted on every 2nd cover/chain link (HS).

As a standard, dividers or the complete divider system (dividers with height separations) are movable in the cross section (**version A**).

Divider system TSO without height separation

Vers.	a _T min [mm]	a _x min [mm]	a _c min [mm]	n _T min
A	11.5	13	10	-

The dividers can be moved in the cross section.

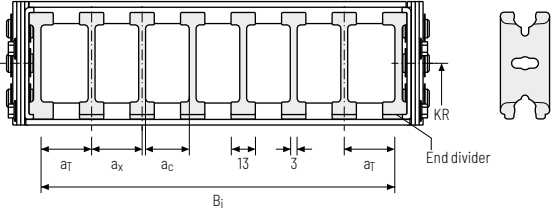

Divider system TS1 with continuous height separation

Vers.	a _T min [mm]	a _x min [mm]	a _c min [mm]	n _T min
A	11.5	13	10	2

The dividers can be moved in the cross section.

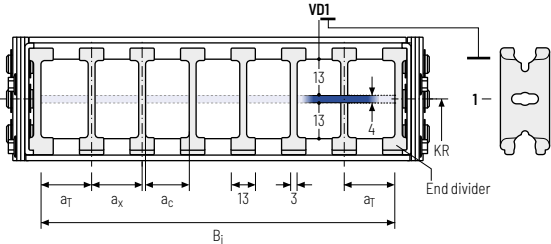

Order example

TS1

·

A

·

3

-

VD0

-

VD1

⋮
- VD1

Divider system
Version
n_T
Height separation

Please state the designation of the divider system (**TS0, TS1...**), version and number of dividers per cross section [n_T].

If using divider systems with height separation (**TS1**) please also state the positions [e.g. VD1] viewed from the left driver belt. You are welcome to add a sketch to your order.

The end dividers are part of the divider system and don't have to be ordered separately.

Subject to change without notice.

	MT series
	XLT series
	ROBOTRAX® System
	FLATVEVOR®
	CLEANVEVOR®
	LS/LSX series
	S/SX series
	S/SX-Tubes series
	Accessories
	TRAXLINE®

End connectors - steel

End connectors made of steel. The connection variants on the fixed point and on the driver can be combined and changed later on, if necessary.

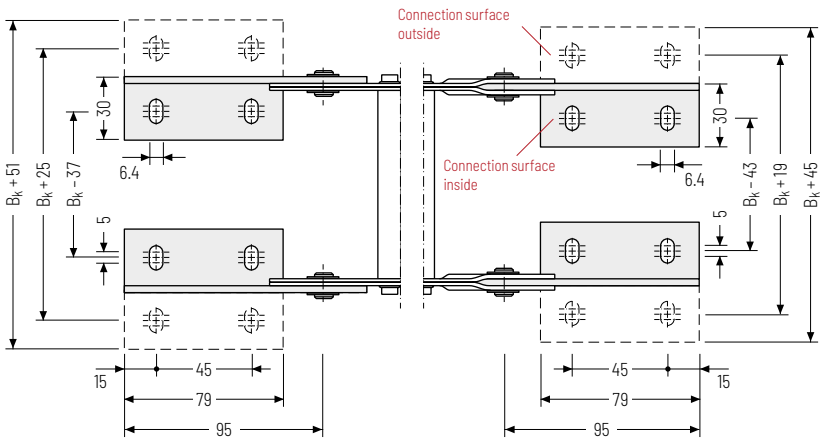
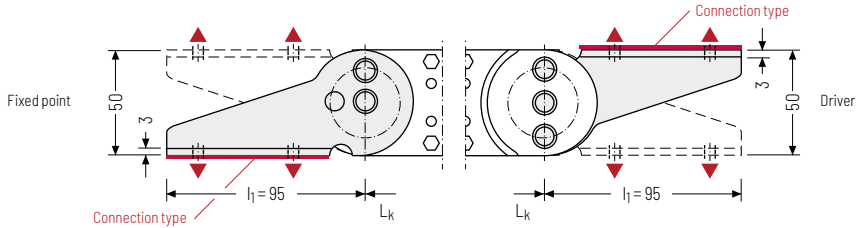

▲ Assembly options

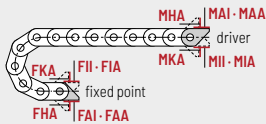

Connection point

F - fixed point
M - driver

Connection type

A - threaded joint to outside (standard)
I - threaded joint to inside
H - threaded joint, rotated 90° to the outside
K - threaded joint, rotated 90° to the inside

Connection surface

A - connection surface inside (standard)
I - connection surface outside

Caution: The standard connection variant FAI/MAI is only possible from B_k of 70 mm.

Order example



Steel	F	A	I
Steel	M	A	I
End connector	Connection point	Connection type	Connection surface



We recommend the use of strain reliefs at the driver and fixed point. See from p. 904.



MT
series

XLT
series

ROBOTRAX®
System

FLATVEYOR®

CLEANVEYOR®

LS/LSX
series

S/SX
series

S/SX-Tubes
series

Accessories

TRAXLINE®

S/SX0950

MT
seriesXLT
seriesROBOTRAX®
System

FLATVEYOR®

CLEANVEYOR®

LS/LSX
seriesS/SX
seriesS/SX-Tubes
series

Accessories

TRAXLINE®



Pitch
95 mm



Inner height
44 mm



Chain widths
125 - 600 mm



Bending radii
170 - 600 mm

Stay variants



Aluminum stay RMD page **788**

Aluminum cover system

- » Bolted aluminum covers for maximum stability.
- » For applications generating chips or coarse contamination.
- » **Inside/outside:** Threaded joint easy to release.



TOTALTRAX® complete systems

Benefit from the advantages of the TOTALTRAX® complete system. A complete delivery from one source – with a warranty certificate on request! Learn more at tsubaki-kabelschlepp.com/totaltrax



TRAXLINE® cables for cable carriers

Hi-flex electric cables which were especially developed, optimized and tested for use in cable carriers can be found at tsubaki-kabelschlepp.com/traxline

Unsupported arrangement

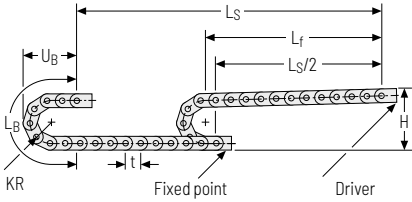

KR [mm]	H [mm]	L _B [mm]	U _B [mm]
170	442	914	395
200	502	1008	425
260	622	1197	485
290	682	1291	515
320	742	1385	545
350	802	1480	575
410	922	1668	635
600	1302	2264	825

Installation height H_z

$H_z = H + 10 \text{ mm/m}$

Load diagram for unsupported length depending on the additional load.

Intrinsic cable carrier weight $q_k = 7.6 \text{ kg/m}$. For other inner widths, the maximum additional load changes.

For cable carriers with a aluminum cover system, a higher intrinsic cable carrier weight is to note.

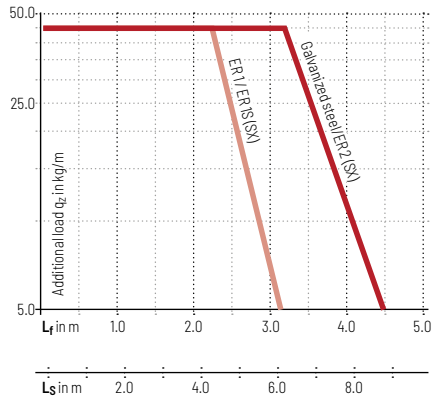

- Speed**
up to 2.5 m/s
- Acceleration**
up to 5 m/s²
- Travel length**
up to 8.8 m
- Additional load**
up to 45 kg/m

Gliding arrangement

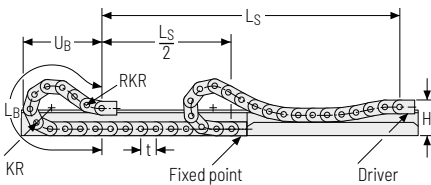

- Speed**
up to 1 m/s
- Acceleration**
up to 2 m/s²
- Travel length**
on request
- Additional load**
up to 45 kg/m

The gliding cable carrier must be guided in a channel. See p. 844.

Glide shoes have to be used for gliding applications.

MT series
XLT series
ROBOTRAX® System
FLATVEYOR®
CLEANVEYOR®
LS/LSX series
S/SX series
S/SX-Tubes series
Accessories
TRAXLINE®

Aluminum stay RMD – aluminum cover system

- » Bolted aluminum covers for maximum stability.
- » For applications generating chips or coarse contamination.
- » Available customized in **1 mm grid**.
- » **Inside/outside:** Threaded joint easy to release.



Stay arrangement on each chain link (**VS: fully-stayed**)



1 mm B_k 125 – 600 mm
in 1 mm width sections

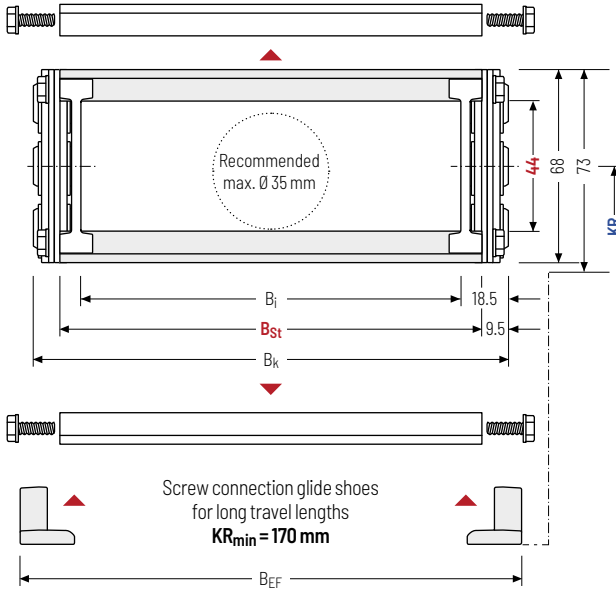

The maximum cable diameter strongly depends on the bending radius and the desired cable type. Please contact us.

Calculating the cable carrier length

Cable carrier length L_k

$$L_k \approx \frac{L_S}{2} + L_B$$

Cable carrier length L_k
rounded to pitch t

h _i [mm]	h _G [mm]	h _{G'} [mm]	B _i [mm]	B _{St} [mm]*	B _k [mm]	B _{EF} [mm]	KR [mm]				q _k [kg/m]
44	68	73	88	106	B _{St} + 19	B _{St} + 28	170	200	260	290	9.97
			563	581			320	350	410	600	21.95

* in 1 mm width sections

Order example



SX0950

Type

107

B_{St}[mm]

RMD

Stay variant

200

KR[mm]

St

Material

2375

L_k[mm]

VS

Stay arrangement

Divider systems

As a standard, the divider system is mounted on every 2nd cover/chain link (HS).

As a standard, dividers or the complete divider system (dividers with height separations) are movable in the cross section (**version A**).

Divider system TSO without height separation

Vers.	a _T min [mm]	a _x min [mm]	a _c min [mm]	n _T min
A	12	14	10	-

The dividers can be moved in the cross section.

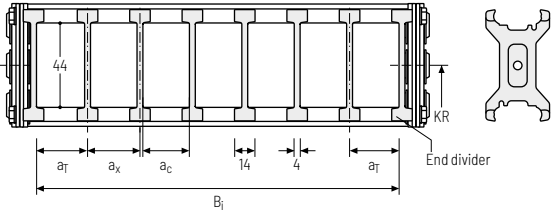

Divider system TS1 with continuous height separation

Vers.	a _T min [mm]	a _x min [mm]	a _c min [mm]	n _T min
A	12	14	10	2

The dividers can be moved in the cross section.

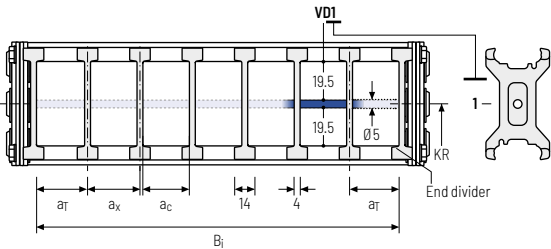

Order example

TS1

·

A

·

3

-

VD0

-

VD1

⋮

VD1

Divider system

Version

n_T

Height separation

Please state the designation of the divider system (**TS0, TS1...**), version and number of dividers per cross section [n_T].

If using divider systems with height separation (**TS1**) please also state the positions [e.g. VD1] viewed from the left driver belt. You are welcome to add a sketch to your order.

The end dividers are part of the divider system and don't have to be ordered separately.

	MT series
	XLT series
	ROBOTRAX® System
	FLATVEVOR®
	CLEANVEVOR®
	LS/LSX series
	S/SX series
	S/SX-Tubes series
	Accessories
	TRAXLINE®



TRAXLINE®

Accessories

S/SX-Tubes
series

S/SX
series

LS/LSX
series

CLEANVEVOR®

FLATVEVOR®

ROBOTRAX®
System

XLT
series

MT
series

S/SX1250



Pitch
125 mm



Inner height
69 mm



Chain widths
150 – 800 mm



Bending radii
200 – 1000 mm

Stay variants



Aluminum stay RMD page **794**

Aluminum cover system

- » Bolted aluminum covers for maximum stability.
- » For applications generating chips or coarse contamination.
- » **Inside/outside:** Threaded joint easy to release.



TOTALTRAX® complete systems

Benefit from the advantages of the TOTALTRAX® complete system. A complete delivery from one source – with a warranty certificate on request! Learn more at tsubaki-kabelschlepp.com/totaltrax



TRAXLINE® cables for cable carriers

Hi-flex electric cables which were especially developed, optimized and tested for use in cable carriers can be found at tsubaki-kabelschlepp.com/traxline

Unsupported arrangement

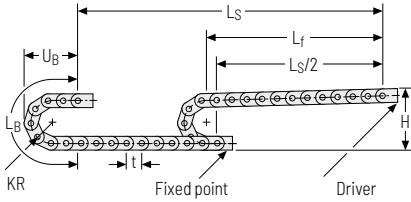

Installation height H_z

$H_z = H + 10 \text{ mm/m}$

Load diagram for unsupported length depending on the additional load.

Intrinsic cable carrier weight $q_k = 13 \text{ kg/m}$. For other inner widths, the maximum additional load changes.

For cable carriers with an aluminum cover system, a higher intrinsic cable carrier weight is to note.

KR [mm]	H [mm]	L _B [mm]	U _B [mm]
200	541	1128	497
220	581	1191	517
260	661	1317	557
300	741	1442	597
340	821	1568	637
380	901	1694	677
420	981	1820	717
460	1061	1945	757
500	1141	2071	797
540	1221	2196	837
600	1341	2385	897
1000	2141	3640	1297

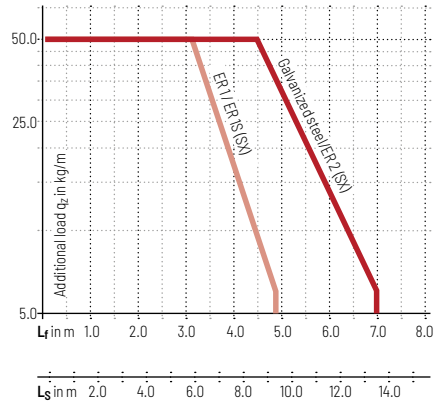

Speed
up to 2.5 m/s

Acceleration
up to 5 m/s²

Travel length
up to 13.5 m

Additional load
up to 50 kg/m

Gliding arrangement

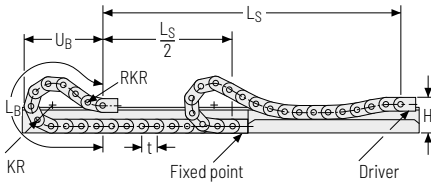

The gliding cable carrier must be guided in a channel. See p. 844.

Glide shoes have to be used for gliding applications.

Speed
up to 1 m/s

Acceleration
up to 2 m/s²

Travel length
on request

Additional load
up to 50 kg/m

Aluminum stay RMD – aluminum cover system

- » Bolted aluminum covers for maximum stability.
- » For applications generating chips or coarse contamination.
- » Available customized in **1 mm grid**.
- » **Inside/outside:** Threaded joint easy to release.



Stay arrangement on each chain link (**VS: fully-stayed**)



1 mm B_k 150 – 800 mm
in 1 mm width sections

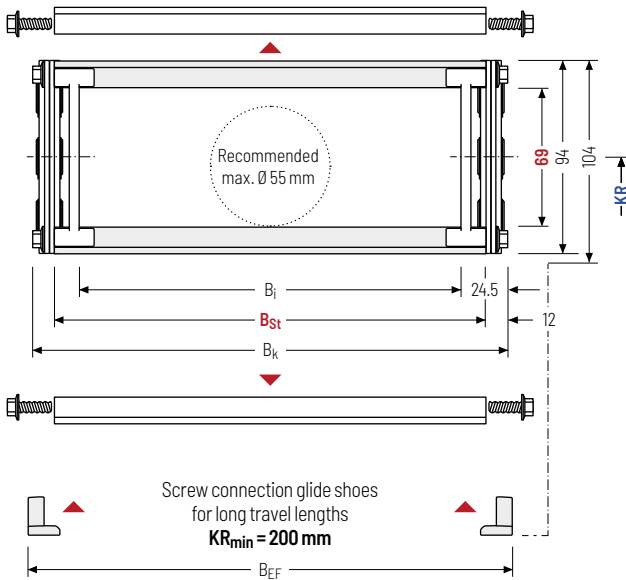

The maximum cable diameter strongly depends on the bending radius and the desired cable type. Please contact us.

Calculating the cable carrier length

Cable carrier length L_k

$$L_k \approx \frac{L_S}{2} + L_B$$

Cable carrier length L_k
rounded to pitch t

h _i [mm]	h _G [mm]	h _{G'} [mm]	B _i [mm]	B _{St} [mm]*	B _k [mm]	B _{EF} [mm]	KR [mm]						q _k [kg/m]
69	94	104	101 75	126 776	B _{St} + 24	B _{St} + 30	200**	220**	260	300	340	380	15.48
							420	460	500	540	600	1000	32.38

* in 1 mm width sections ** geometrically reduced inner height

Order example



S1250

Type

352

B_{St}[mm]

RMD

Stay variant

260

KR[mm]

St

Material

4750

L_k[mm]

VS

Stay arrangement

Divider systems

As a standard, the divider system is mounted on every 2nd cover/chain link (HS).

As a standard, dividers or the complete divider system (dividers with height separations) are movable in the cross section (**version A**).

Divider system TS0 without height separation

Vers.	a _T min [mm]	a _x min [mm]	a _c min [mm]	π _T min
A	17.5	20	15	-

The dividers can be moved in the cross section.

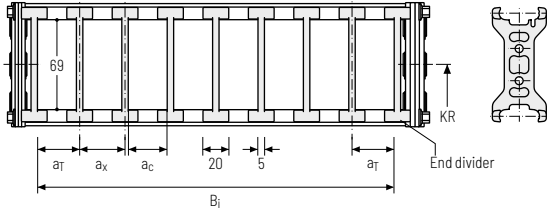

Divider system TS1 with continuous height separation

Vers.	a _T min [mm]	a _x min [mm]	a _c min [mm]	π _T min
A	10	12	8	2

The dividers can be moved in the cross section.

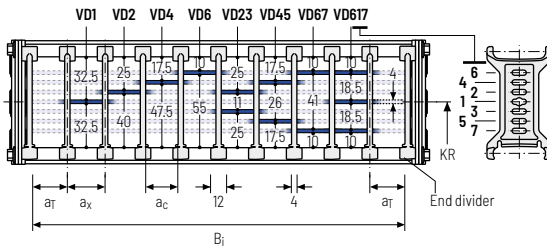

Divider system TS2 with partial height separation

Vers.	a _T min [mm]	a _x min [mm]	a _c min [mm]	π _T min
A	11*/17**	14*/21	8*/15	2

* For VR0 ** For version with height separation to the end divider

With grid distribution (1 mm grid). The dividers are attached by the height separation, the grid can be moved in the cross section.

Sliding dividers are optionally available (thickness of divider = 4 mm).

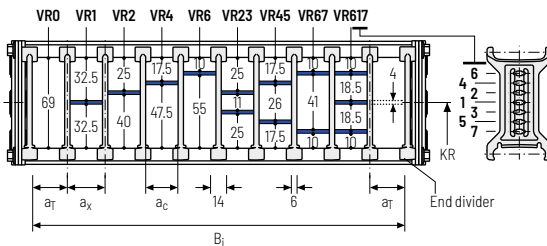

Order example

TS2

A

3

K1

34

VR1

⋮

K4

38

VR3

Divider system
Version
π_T
Chamber
a_x
Height separation

	MT series
	XLT series
	ROBOTRAX® System
	FLATVEVOR®
	CLEANVEVOR®
	LS/LSX series
	S/SX series
	S/SX-Tubes series
	Accessories
	TRAXLINE®

End connectors - steel

End connectors made of steel. The connection variants on the fixed point and on the driver can be combined and changed later on, if necessary.

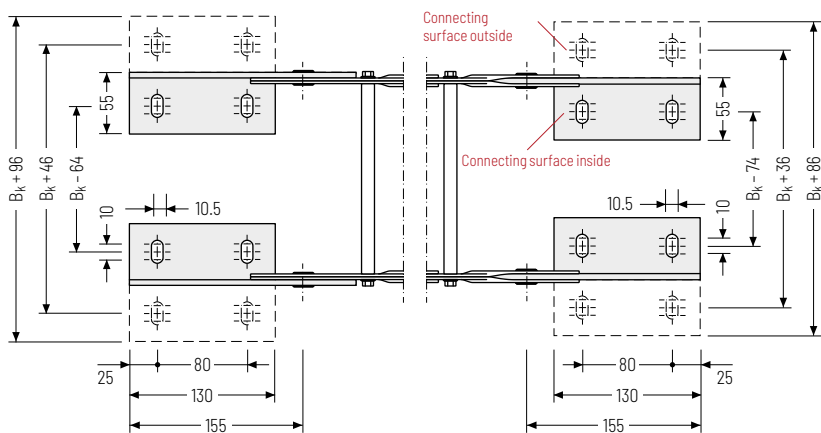
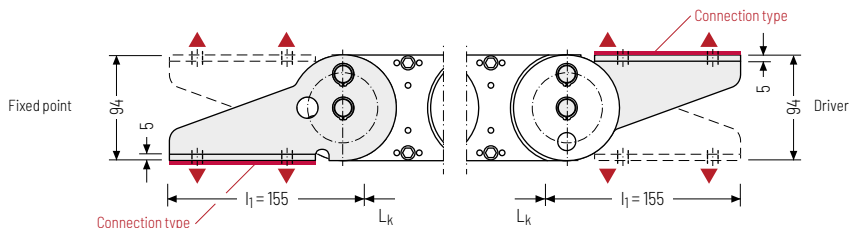

▲ Assembly options

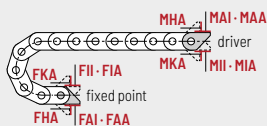

Connection point

F - fixed point
M - driver

Connection type

A - threaded joint to outside (standard)
I - threaded joint to inside
H - threaded joint, rotated 90° to the outside
K - threaded joint, rotated 90° to the inside

Connection surface

A - connection surface inside (standard)
I - connection surface outside

Caution: The standard connection variant FAI/MAI is only possible from B_k of 125 mm.

Order example



Steel	F	A	I
Steel	M	A	I
End connector	Connection point	Connection type	Connection surface



We recommend the use of strain reliefs at the driver and fixed point. See from p. 904.

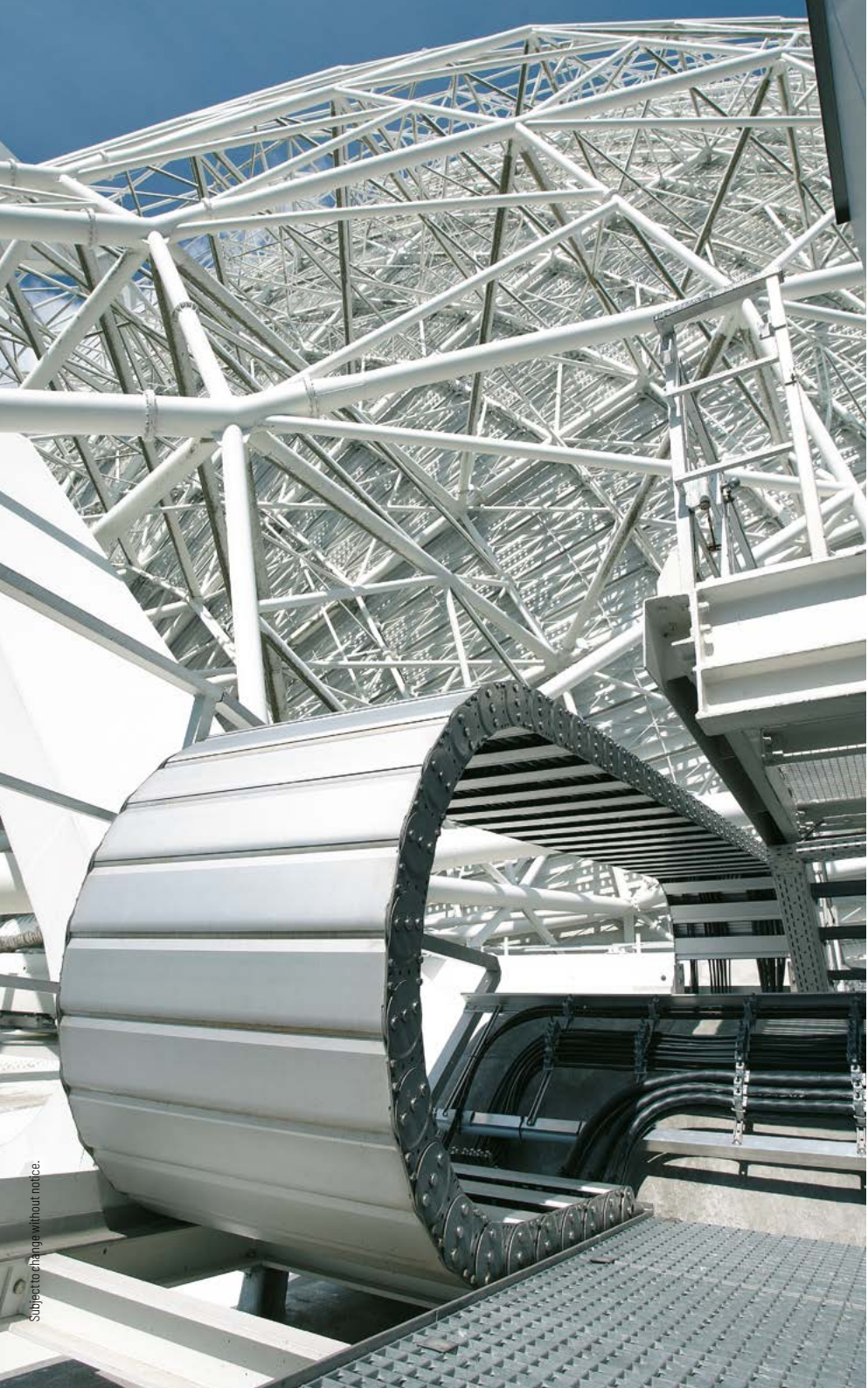

Subject to change without notice.

797

MT
series

XLT
series

ROBOTRAX®
System

FLATVEYOR®

CLEANVEYOR®

LS/LSX
series

S/SX
series

S/SX-Tubes
series

Accessories

TRAXLINE®

S/SX1800



Pitch
180 mm



Inner height
104 mm



Chain widths
250 - 1000 mm



Bending radii
320 - 1300 mm

Stay variants



Aluminum stay RMD page 800

Aluminum cover system

- » Bolted aluminum covers for maximum stability.
- » For applications generating chips or coarse contamination.
- » **Inside/outside:** Threaded joint easy to release.



TOTALTRAX® complete systems

Benefit from the advantages of the TOTALTRAX® complete system.
A complete delivery from one source - with a warranty certificate on request!
Learn more at tsubaki-kabelschlepp.com/totaltrax



TRAXLINE® cables for cable carriers

Hi-flex electric cables which were especially developed,
optimized and tested for use in cable carriers can be
found at tsubaki-kabelschlepp.com/traxline

Unsupported arrangement

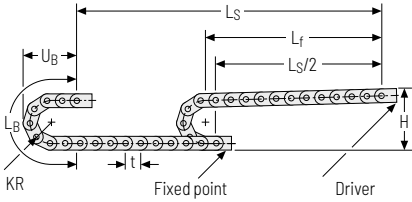

KR [mm]	H [mm]	LB [mm]	UB [mm]
320	850	1725	750
375	960	1898	805
435	1080	2087	865
490	1190	2259	920
605	1420	2620	1035
720	1650	2982	1150
890	1990	3516	1320
1175	2560	4411	1605
1300	2810	4804	1730

Installation height H_2





$$H_2 = H + 10 \text{ mm/m}$$

Load diagram for unsupported length depending on the additional load.

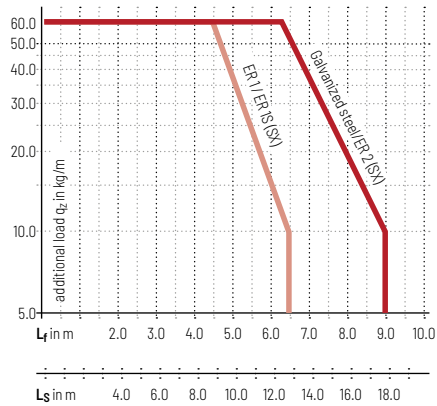
Intrinsic cable carrier weight $q_k = 26 \text{ kg/m}$. For other inner widths, the maximum additional load changes.

For cable carriers with a aluminum cover system, a higher intrinsic cable carrier weight is to note.



-  **Speed**
up to 2 m/s
-  **Acceleration**
up to 3 m/s²
-  **Travel length**
up to 17.8 m
-  **Additional load**
up to 60 kg/m

Gliding arrangement

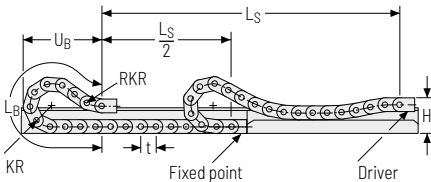

 The gliding cable carrier must be guided in a channel. See p. 844.

Glide shoes have to be used for gliding applications.

-  **Speed**
up to 0.8 m/s
-  **Acceleration**
up to 2 m/s²
-  **Travel length**
on request
-  **Additional load**
up to 60 kg/m

MT series
XLT series
ROBOTRAX® System
FLATVEYOR®
CLEANVEYOR®
LS/LSX series
S/SX series
S/SX-tubes series
Accessories
TRAXLINE®

Aluminum stay RMD – aluminum cover system

- » Bolted aluminum covers for maximum stability.
- » For applications generating chips or coarse contamination.
- » Available customized in **1 mm grid**.
- » **Inside/outside:** Threaded joint easy to release.



Stay arrangement on each chain link (**VS: fully-stayed**)



1 mm B_k 250 – 1000 mm
in **1 mm** width sections

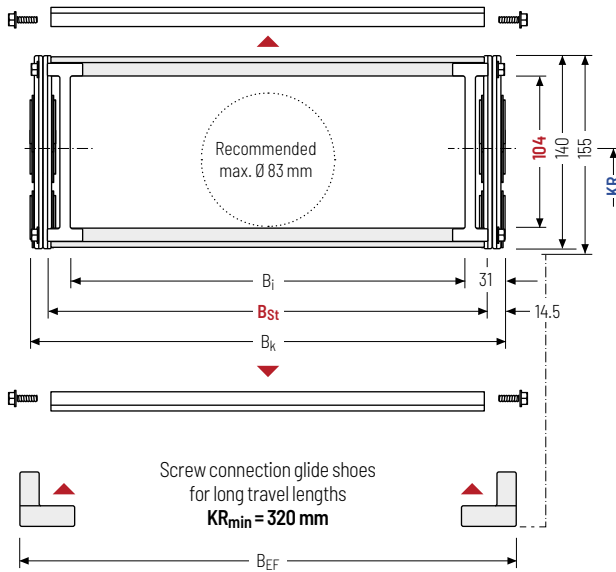

The maximum cable diameter strongly depends on the bending radius and the desired cable type. Please contact us.

Calculating the cable carrier length

Cable carrier length L_k

$$L_k \approx \frac{L_S}{2} + L_B$$

Cable carrier length L_k
rounded to pitch t

h _i [mm]	h _g [mm]	h _{g'} [mm]	B _i [mm]	B _{St} [mm]*	B _k [mm]	B _{EF} [mm]	KR [mm]			q _k [kg/m]
104	140	155	188	221	B _{St} + 29	B _{St} + 40	320	375	435	28.46
			938	971			720	890	1175	47.67
							490	605	1300	

* in 1 mm width sections

Order example



S1800

Type

417

B_{St} [mm]

RMD

Stay variant

375

KR [mm]

St

Material

5940

L_k [mm]

VS

Stay arrangement

Divider systems

As a standard, the divider system is mounted on every 2nd cover/chain link (HS).

As a standard, dividers or the complete divider system (dividers with height separations) are movable in the cross section (**version A**).

Divider system TS0 without height separation

Vers.	a _T min [mm]	a _x min [mm]	a _c min [mm]	π _T min
A	21.5	25	17.5	-

The dividers can be moved in the cross section.

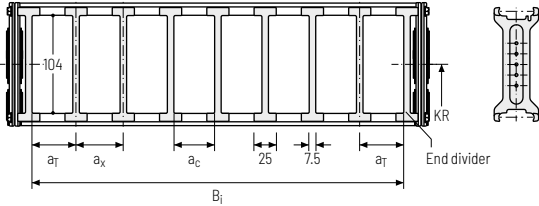

Divider system TS1 with continuous height separation

Vers.	a _T min [mm]	a _x min [mm]	a _c min [mm]	π _T min
A	21.5	25	17.5	2

The dividers can be moved in the cross section.

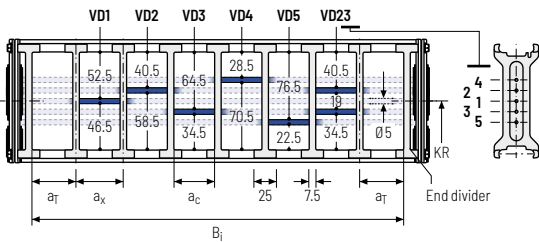

Divider system TS3 with height separation consisting of plastic partitions

Vers.	a _T min [mm]	a _x min [mm]	a _c min [mm]	π _T min
A	38*/16.5**/12***	16/42*	8	2

* For aluminum partitions
 ** For VRO
 *** For version with height separation to the end divider

The dividers are fixed with the partitions. The entire divider system can be moved in the cross section.

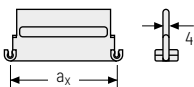
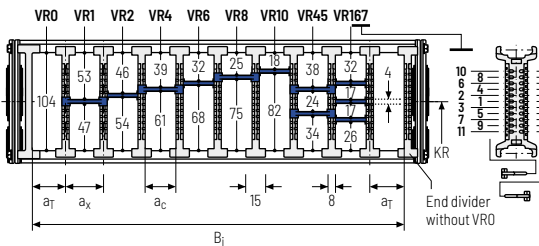

Aluminum partitions in 1 mm increments with a_x > 42 mm are also available.

a _x (center distance of dividers) [mm]											
a _c (nominal width of inner chamber) [mm]											
16	18	23	28	32	33	38	43	48	58	64	68
8	10	15	20	24	25	30	35	40	50	56	60
78	80	88	96	112	128	144	160	176	192	208	
70	72	80	88	104	120	136	152	168	184	200	

When using plastic partitions with a_x > 112 mm, we recommend an additional center support with a twin divider (S_T = 5 mm). Twin dividers are also suitable for retrofitting in the partition system.

MT series
XLT series
ROBOTRAX® System
FLATVEVOR®
CLEANVEVOR®
LS/LSX series
S/SX series
S/SX-Tubes series
Accessories
TRAXLINE®

End connectors - steel

End connectors made of steel. The connection variants on the fixed point and on the driver can be combined and changed later on, if necessary.

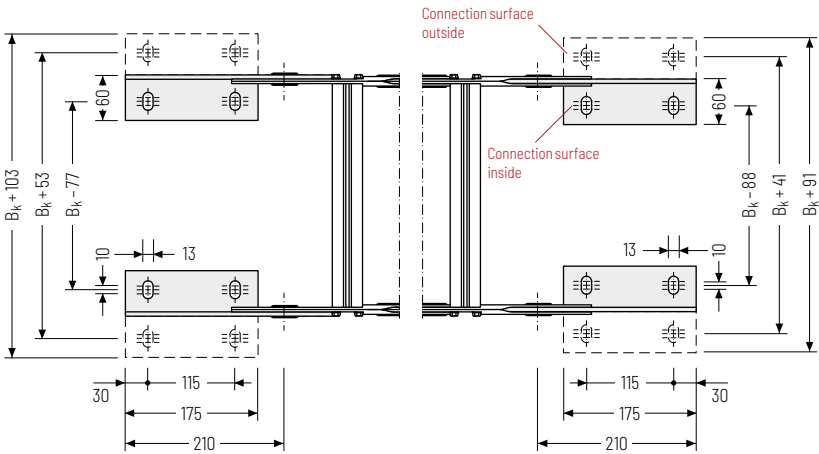
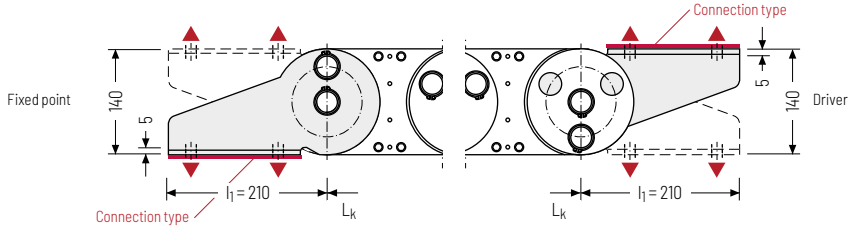

▲ Assembly options

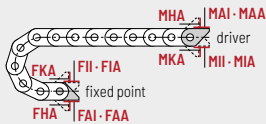

Connection point

F - fixed point
M - driver

Connection type

A - threaded joint to outside (standard)
I - threaded joint to inside
H - threaded joint, rotated 90° to the outside
K - threaded joint, rotated 90° to the inside

Connection surface

A - connection surface inside (standard)
I - connection surface outside

Caution: The standard connection variant FAI/MAI is only possible from B_k of 139 mm.

Order example

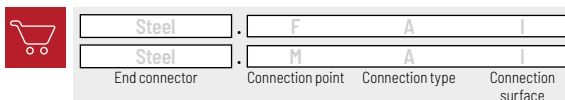

We recommend the use of strain reliefs at the driver and fixed point. See from p. 904.



Subject to change without notice.

803

MT
series

XLT
series

ROBOTRAX®
System

FLATVEYOR®

CLEANVEYOR®

LS/LSX
series

S/SX
series

S/SX-Tubes
series

Accessories

TRAXLINE®

MT
seriesXLT
seriesROBOTRAX®
System

FLATVEYOR®

CLEANVEYOR®

LS/LSX
seriesS/SX
seriesS/SX-Tubes
series

Accessories

TRAXLINE®

Accessories

for cable carriers

The extensive range of accessories allow cable carriers to be ideally adapted to your specific application. With the accessories for the cable carriers, the cable routing can be assembled from standard components to form a complete cable carrier system. We can also supply a pre-assembled TOTALTRAX® complete system.

- » Support tray and guide channels made from steel and aluminum
- » Driver connection for optimum transfer of the cables and hoses to the consuming units
- » Support rollers for longer unsupported lengths
- » Support and guide elements for optimum gliding and rolling
- » RSC – rolling instead of gliding on particularly long travel lengths
- » Strain reliefs for optimum placement with dynamic use of cables
- » Steel band covers as continuous, cost-effective protection against chips and other external influences
- » Opening tools reduce assembly times and save costs



Support trays and guide channels Page 834

Reliable unrolling and optimum gliding for long travel lengths



Condition Monitoring Page 894

Knowing what's (not) up



Floating Moving Device (TKFMD) Page 896

Optimum transfer of cables



Support rollers Page 898

For longer unsupported lengths

Not all technical data and parameters are reached in each individual case, but are depending on the respective type of application and product configuration. Legally binding insofar is only the individual information provided for the specifically requested particular case. Please contact us - we will be happy to advise you!

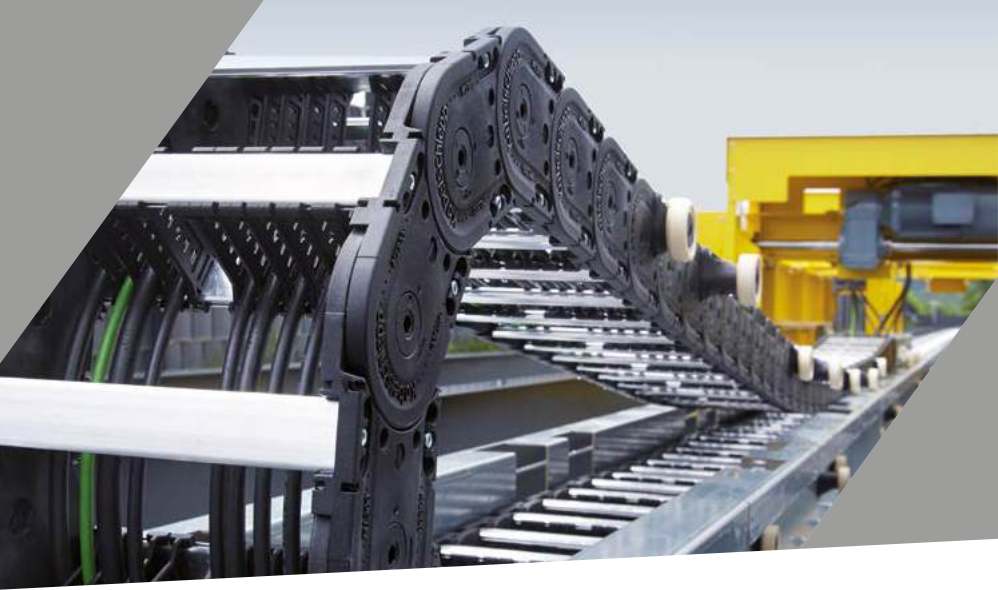
MT
seriesXLT
seriesROBOTRAX®
System

FLATVEYOR®

CLEANVEYOR®

LS/LSX
seriesS/SX
seriesS/SX-Tubes
series

Accessories

TRAXLINE®



RSC – Roller Supported Chain Page 902

Cable carriers on rollers for particularly long travel lengths



Strain relief devices Page 904

For optimum placement with dynamic use of cables



Steel strip covers Page 916

Continuous, cost-effective protection against chips and other external influences



Opening tools Page 918

Reduce assembly times and save costs







Support trays and guide channels

Reliable unrolling and optimum gliding for long travel lengths



Trademarks are legally protected for the TSUBAKI KABELSCHLEPP GmbH as a national or international registration in the following countries: tsubaki-kabelschlepp.com/trademarks

Subject to change without notice.

Type	One-piece	Multi-piece	Standard length [mm]	Custom length	Material				Easy alignment	Variable width	Flexible distances of the channel mounting	Channel mounting		Channel bottom		Robust design	Page
					StVz	V2A	V4A	Al alloy				inside	outside	open	closed		
Support trays																	
	•	•	2000/ 3000	•	•	•	•	-	•	•	-	•	-	•	•	-	808
Standard channel																	
	•	-	2000/ 3000	•	•	•	•	-	•	-	•	-	•	•	•	•	820
Steel Guide System (TKSG)																	
	-	•	1000/ 2000	-	•	•	•	-	•	•	-	-	•	•	-	•	830
Channel enclosure																	
	-	•	1000/ 2000	-	•	•	•	-	•	•	-	-	•	-	•	•	835
Alu Guide System (TKAL)																	
	-	•	2000	•	-	-	-	•	•	•	•	•	•	•	-	•	836
Easy Guide System (TKEG)																	
	•	•	2000	•	•	•	•	-	•	-	•	-	•	-	•	-	844
Vertical Guide System (TKVG)																	
	-	•	3000	•	-	-	-	•	•	-	•	-	•	-	•	•	864

MT series

XLT series

ROBOTRAX® System

FLATVEYOR®

CLEANVEYOR®

LS/LSX series

S/SX series

S/SX-Tubes series

Accessories

TRAXLINE®

Support trays

An even surface is required for reliable unrolling of the unsupported cable carrier. If this is not already provided on site, a support tray has to be used. If required, we supply our cable carriers with a suitable support tray for your application. This ensures quiet movement of the lower run with reduced wear, reducing costs and design work.

All support trays are available in zinc plated sheet steel or stainless steel. The selection depends on the conditions of use. The simple design allows easy fixing and omits complex individual constructions. The standard lengths are 2000 mm / 3000 mm. Special lengths on request.

MT
seriesXLT
seriesROBOTRAX®
System

FLATVEYOR®

CLEANVEYOR®

LS/LSX
seriesS/SX
seriesS/SX-Tubes
series

Accessories

TRAXLINE®

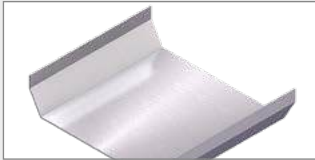

One part (standard) Page 810

Support tray, one part, closed

- Steel profile, folded on both sides.
- Available in zinc plated sheet steel or stainless steel.
- Available for all cable carrier types
- Standard lengths 2000 / 3000 mm, special lengths in 1 mm sections.

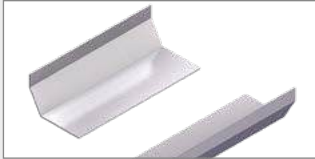

Two parts Page 811

Support tray, two parts, open

- Steel profiles, folded on one side.
- Available in zinc plated sheet steel or stainless steel.
- Available for all cable carrier types.
- Standard lengths 2000 / 3000 mm, special lengths in 1 mm sections.



no change without notice.

TRAXLINE®

Accessories

S/SX-Tubes
series

S/SX
series

LS/LSX
series

CLEANEVOR®

FLATEVOR®

ROBOTRAX®
System

XLT
series

MT
series

809

One part – closed (standard)

- Steel profile, folded on both sides.
- Zinc plated sheet steel or stainless steel.
- Available for all cable carrier types.
- Standard lengths 2000 / 3000 mm, special lengths in 1 mm sections.

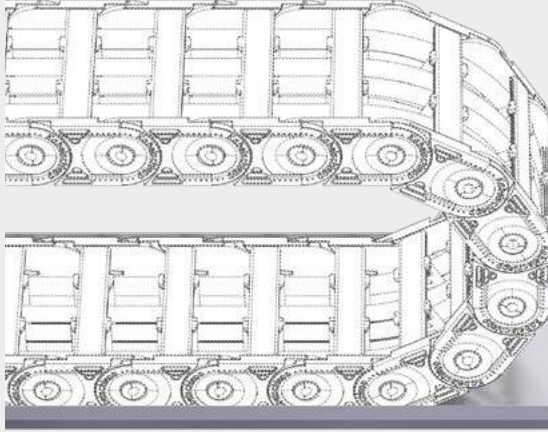

Zinc plated sheet steel / stainless steel



Standard lengths 2000 / 3000 mm
Special lengths on request

LS/SX series

S/SX series

S/SX-Tubes series

Accessories

TRAXLINE®

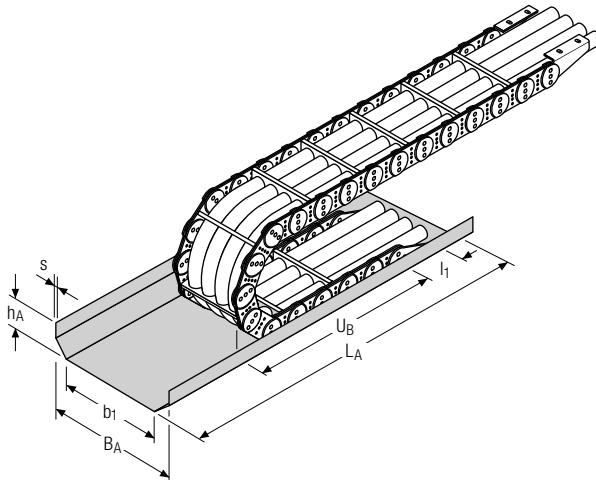

Calculating the support tray length

Support tray length L_A

$$L_A = \frac{L_S}{2} + U_B + l_1$$

(for standard connection)



With upstream strain relief on the fixed point, the support trays have to be made accordingly longer.



The use of a one part support tray depends on the the cable carrier. Please contact us.

Two parts – open

- Steel profiles, folded on one side.
- Zinc plated sheet steel or stainless steel.
- Available for all cable carrier types.
- Standard lengths 2000 / 3000 mm, special lengths in 1 mm sections.
- Variable widths.

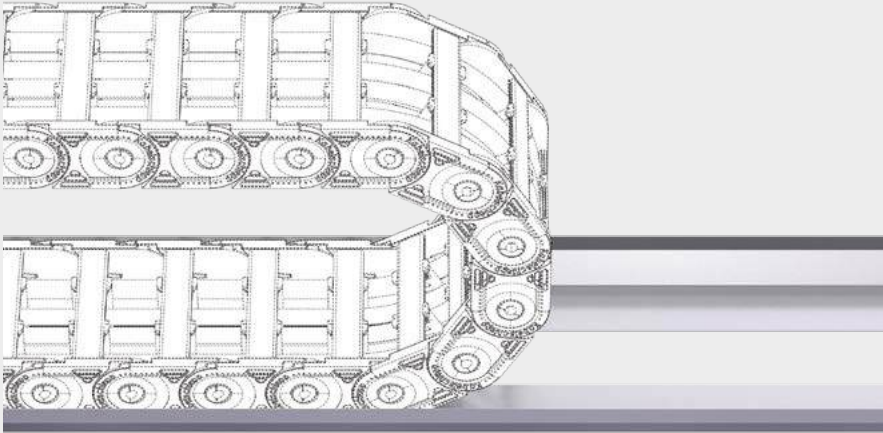

 Zinc plated sheet steel / stainless steel

 Standard lengths 2000 / 3000 mm
Special lengths on request

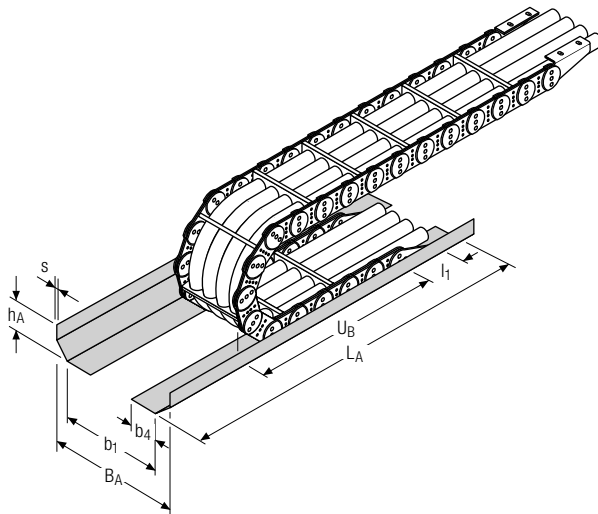



Calculating the support tray length

Support tray length L_A

$$L_A = \frac{L_S}{2} + U_B + l_1$$

(for standard connection)

 With upstream strain relief on the fixed point, the support trays have to be made accordingly longer

 The use of a two part support tray depends on the cable carrier. Please contact us.

MT series

XLT series

ROBOTRAX® System

FLATVEYOR®

CLEANVEYOR®

LS/LSX series

S/SX series

S/SX-Tubes series

Accessories

TRAXLINE®

Dimensions

One part – closed (standard)

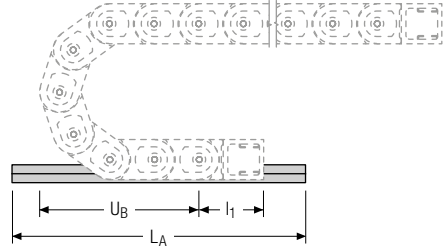
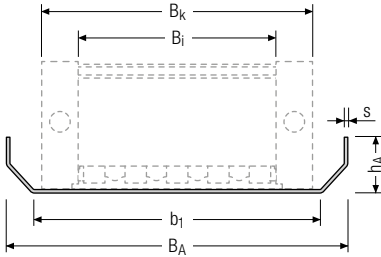

Two parts – open

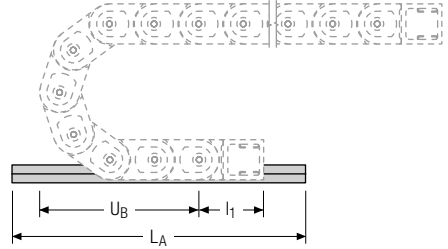
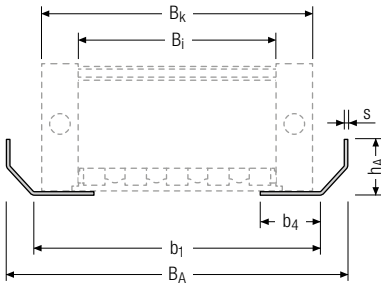

UNIFLEX Advanced series

	B_k [mm]	b_1 [mm]	b_4 [mm]	B_A [mm]	h_A [mm]	s [mm]
UA1455 page 162	$B_i + 16$	$B_k + 6$	25	$B_k + 21$	20	1.5
UA1555 page 172	$B_i + 18$	$B_k + 6$	30	$B_k + 21$	20	1.5
UA1665 page 182	$B_i + 22$	$B_k + 15$	40	$B_k + 40$	30	2
UA1775 page 194	$B_i + 26$	$B_k + 15$	55	$B_k + 40$	30	2
UA1995 page 202/340	$B_i + 30$	$B_k + 20$	60	$B_k + 60$	50	2



The use of a two part support tray strongly depends on the inner width used in the cable carrier. For small inner widths, we recommend using one part support trays. Please contact us.

Dimensions

TKP35 series

B_k [mm]	b_1 [mm]	b_4 [mm]	B_A [mm]	h_A [mm]	s [mm]
TKP35 page 216					
$B_i + 12$	$B_k + 6$	25	$B_k + 21$	20	1.5

EasyTrax® series

B_k [mm]	b_1 [mm]	b_4 [mm]	B_A [mm]	h_A [mm]	s [mm]
ET1455 page 256					
$B_i + 16$	$B_k + 6$	25	$B_k + 21$	20	1.5

K series

B_k [mm]	b_1 [mm]	b_4 [mm]	B_A [mm]	h_A [mm]	s [mm]
K0650 page 304					
$B_i + 28$	$B_k + 15$	40	$B_k + 40$	30	2
K0900 page 318					
$B_i + 31$	$B_k + 15$	55	$B_k + 40$	30	2

M series

B_k [mm]	b_1 [mm]	b_4 [mm]	B_A [mm]	h_A [mm]	s [mm]
M0475 page 364					
$B_i + 17$	$B_k + 6$	30	$B_k + 21$	20	1.5
M0650 page 372					
$B_i + 34$	$B_k + 15$	40	$B_k + 40$	30	2
M0950 page 388					
$B_i + 39$	$B_k + 15$	55	$B_k + 40$	30	2
M1250 page 414					
$B_i + 45$	$B_k + 20$	60	$B_k + 60$	50	3
M1300 page 440					
$B_i + 50$	$B_k + 20$	55	$B_k + 60$	50	3

 MT
series

 XLT
series

 ROBOTRAX®
System

FLATVEYOR®

CLEANVEYOR®

 LS/LSX
series

 S/SX
series

 S/SX-Tubes
series

Accessories

TRAXLINE®

Dimensions

XL series

B_k [mm]	b_1 [mm]	b_4 [mm]	B_A [mm]	h_A [mm]	s [mm]
XL1650 page 480					
$B_i + 68$	$B_k + 20$	70	$B_k + 60$	70	3

QUANTUM® series

B_k [mm]	b_1 [mm]	b_4 [mm]	B_A [mm]	h_A [mm]	s [mm]
Q040 page 490					
$B_i + 40$	$B_k + 6$	30	$B_k + 21$	20	1.5
Q060 page 496					
$B_i + 52$	$B_k + 15$	40	$B_k + 40$	30	2
Q080 page 506					
$B_i + 72$	$B_k + 15$	55	$B_k + 40$	30	2
Q100 page 520					
$B_i + 82$	$B_k + 20$	60	$B_k + 60$	50	3

TKR series

B_k [mm]	b_1 [mm]	b_4 [mm]	B_A [mm]	h_A [mm]	s [mm]
TKR0200 page 544					
$B_i + 16$	$B_k + 6$	25	$B_k + 21$	20	1.5
TKR0260 page 550					
$B_i + 26$	$B_k + 15$	40	$B_k + 40$	30	2
TKR0280 page 556					
$B_i + 30$	$B_k + 15$	40	$B_k + 40$	30	2



The use of a two part support tray strongly depends on the inner width used in the cable carrier. For small inner widths, we recommend using one part support trays. Please contact us.

Dimensions

TKA series

B_k [mm]	b_1 [mm]	b_4 [mm]	B_A [mm]	h_A [mm]	s [mm]
TKA38 page 580					
$B_i + 16$	$B_k + 6$	25	$B_k + 21$	20	1.5
TKA45 page 586					
$B_i + 16$	$B_k + 6$	25	$B_k + 21$	20	1.5
TKA55 page 594					
$B_i + 21$	$B_k + 15$	40	$B_k + 40$	30	2

LS/LSX series

B_k [mm]	b_1 [mm]	b_4 [mm]	B_A [mm]	h_A [mm]	s [mm]
LS/LSX1050 page 700					
$B_{St} + 16/18$	$B_k + 15$	55	$B_k + 40$	30	2

S/SX series

B_k [mm]	b_1 [mm]	b_4 [mm]	B_A [mm]	h_A [mm]	s [mm]
S/SX0650 page 726					
$B_{St} + 15/17$	$B_k + 15$	40	$B_k + 40$	30	2
S/SX0950 page 736					
$B_{St} + 19/21$	$B_k + 15$	55	$B_k + 40$	30	2
S/SX1250 page 748					
$B_{St} + 24/26$	$B_k + 20$	60	$B_k + 60$	50	3
S/SX1800 page 772					
$B_{St} + 29/32$	$B_k + 20$	70	$B_k + 60$	50	3
S/SX2500 page 782					
$B_{St} + 32$	$B_k + 25$	100	$B_k + 75$	80	3
S/SX3200 page 788					
$B_{St} + 40$	$B_k + 25$	100	$B_k + 75$	80	3



We will also be happy to manufacture support trays for types 5000 to 9000. Please contact us.

Order

Support trays

To order the support tray, we need the following information:

- Number of support trays
- Material
- Version of support tray (one part/two parts)
- Part length
- Total length of support tray
- Cable carrier type
- Height of support tray h_A
- Inner width of support tray b_1

Guide channels

Guide channels are important elements for the reliable functioning with long travel lengths. The upper run of the cable carrier slides on the lower run and on the sliding area of the guide channel behind the fixed point. Guide channels prevent the upper run from slipping off the lower

run, ensuring quiet running with low wear. For vertical applications such as elevators or storage and retrieval systems, a vertical channel provides optimum guiding.

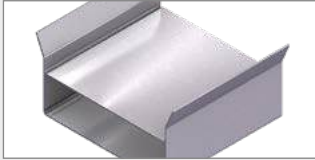

Standard channel..... Page 820

Sheet steel guide channels

- Simple version with customized fixing options.
- Zinc plated sheet steel or stainless steel.
- Standard lengths.



Steel Guide System (TKSG)..... Page 830

Guide channels in the modular system

- Modular system with optimized design for long travel lengths.
- Zinc plated sheet steel or stainless steel.
- Easy installation.



Channel enclosure..... Page 835

Cover for guide channels

- Optimum protection against external influences.
- Easy access for inspection.
- Modular design.



Alu Guide System (TKAL)..... Seite 836

Aluminium guide channels in the modular system

- Modular system with many mounting options.
- Standard lengths and sets.
- Lightweight design for high speeds.



Technical data on p. 818

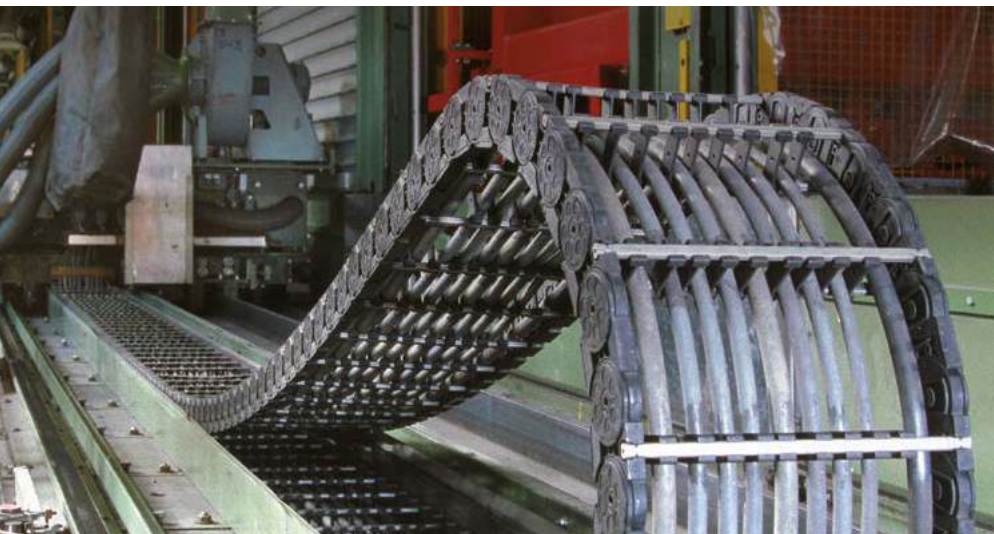

Easy Guide System (TKEG) Page 844

Guide channels for multifunctional use

- Flexible use in many areas of application.
- Made of zinc plated sheet steel or stainless steel.



Vertical Guide System (TKVG) Page 864

Guide channels for vertical hanging applications

- Ready-to-install channel system made of aluminum.
- Standardized module.
- Easy installation.
- For elevators, storage and retrieval systems and many other applications.



Assembly profiles Page 865

Assembly profiles for guide channels

- Assembly profiles with sloping sides can be used for all guide channels for fastening
- Lengths in 50 mm grid possible

MT
seriesXLT
seriesROBOTRAX®
System

FLATVEYOR®

CLEANVEYOR®

LS/LSX
seriesS/SX
seriesS/SX-Tubes
series

Accessories

TRAXLINE®

Opposite arrangement – with lower driver connection and reverse bending radius (standard)

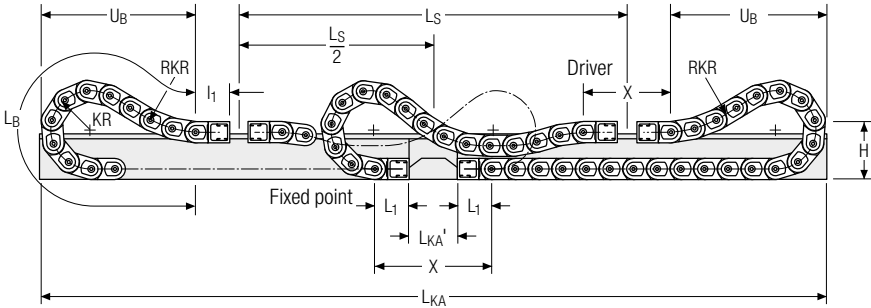

Calculating the channel length

Channel length L_{KA}

$$L_{KA} = L_S + 2 U_B + X$$

Calculating the connection height

Connection height H

$$H = 3 h_G$$

Calculating the slide support length

slide support length L_{KA}'

$$L_{KA}' = X - 2 L_1$$

Opposite arrangement – high connection

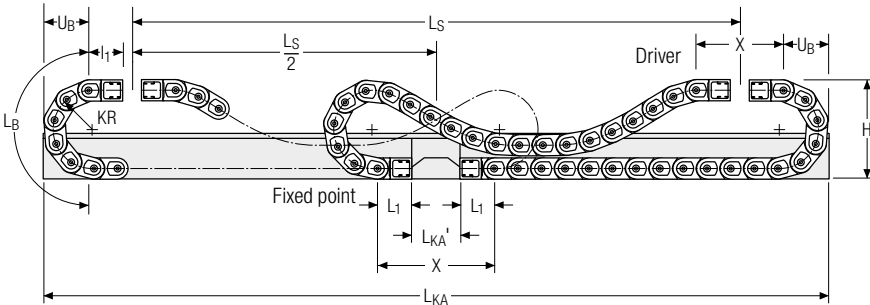

Calculating the channel length

Channel length L_{KA}

$$L_{KA} = L_S + 2 U_B + X$$

Connection height high connection

Connection height H

$$H = 2 \times KR + h_G$$

Calculating the slide support length

slide support length L_{KA}'

$$L_{KA}' = X - 2 L_1$$

i Depending on the chain size, the inner channel width is 4-6 mm larger than the width of the guided cable carrier. Depending on the travel length, the connection height of the cable carrier must be reduced. Please contact us! We will be happy to calculate the suitable guide channel for your application.

i The calculated channel and support lengths are rounded to a reasonable production or installation dimension of the section lengths. A possible travel reserve must be taken into account. Standard section lengths are specified for each channel design.

i For different distances between the fixed points and drivers in your application please contact us.

Sheet steel guide channels

- Simple version with customized fixing options.
- Zinc plated sheet steel or stainless steel.
- Standard lengths.

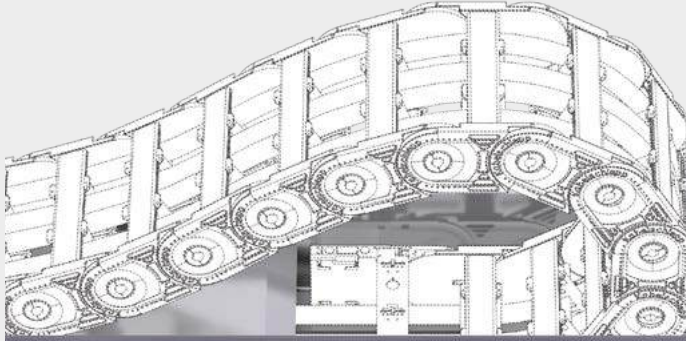

Zinc plated sheet steel /
stainless steel



Standard lengths 2000 / 3000 mm
Special lengths on request

Features

- Universal installation – the channel side walls do not require aligning as there are no single side walls
- Large support widths through sturdy U-design
- Optionally available as a corrosion resistant, sea water resistant version
- Easy fixing options:
 - standard angle brackets for screwing
 - welded on directly on site
 - different fixing variants

Individual solutions

We can also manufacture customized sheet steel guide channels for your application, taking into account virtually any request regarding customized shapes and fixing options.



Information on dimensions can be found from p. 822

MT
seriesXLT
seriesROBOTRAX®
System

FLATVEYOR®

CLEANVEYOR®

LS/LSX
seriesS/SX
seriesS/SX-Tubes
series

Accessories

TRAXLINE®

One-sided arrangement

For one-sided arrangement of the cable carrier, the cable carrier slides behind the fixed point on a continuous slide support with run-on bevels.

Closed design

One part channel closed at the bottom and one part slide support with run-on bevels.



Open design

One part channel closed at the bottom and divided slide support with run-on bevels.

Dirt and liquids can drop through without restrictions.



Opposite arrangement

For opposite arrangement, a slide support is also attached for bridging between the fixed point connections.

Closed design

One part channel closed at the bottom and one part slide support with run-on bevels.

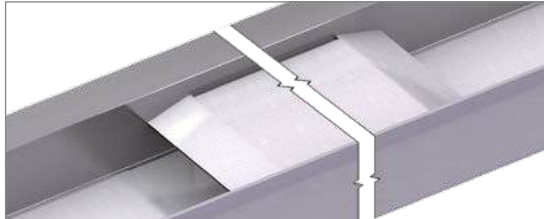

Open design

One part channel closed at the bottom and divided slide support with run-on bevels.

Dirt and liquids can drop through without restrictions.

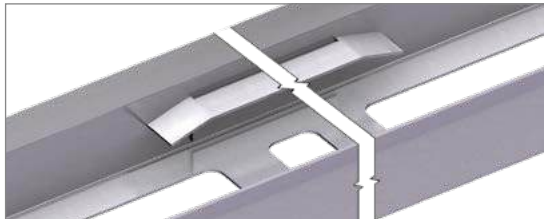

 A special slide support can be adhered to reduce sliding resistance and abrasion between cable carrier and support. We recommend the use of special slide supports for velocities > 0.5 m/s and for frequent move cycles.

Dimensions

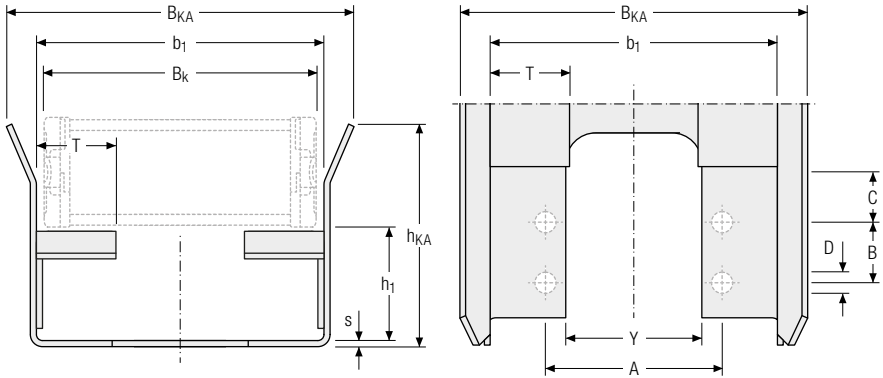

 From $h_{kA} \geq 200$ mm, the guide channel flanks are additionally stabilized with alignment flanges or with connecting flanges.

 The dimension y refers only to open guide channel versions.

UNIFLEX *Advanced* series

Type	h_1 [mm]	h_{kA} [mm]	b_1 [mm]	B_{kA} [mm]	s [mm]	A [mm]	B [mm]	C [mm]	D [mm]	T^* [mm]	Y^{**} [mm]		
UA1455 page 162													
-	36	70 (KR < 100) 125 (KR \geq 100)	$B_k + 4$	$B_k + 24$	2	$b_1 - 34.0$ (FA-A)	-	40	6.2	30	$b_1 - 65$		
			$B_k + 7$	$b_1 - 34.5$ (FA-L)		50					5.3	$b_1 - 40$	
			$B_k + 7$	$B_k + 27$		$b_1 - 13.5$ (FU)					50	5.3	$b_1 - 40$
Glide shoes	38.5	70 (KR < 100) 125 (KR \geq 100)	$B_k + 7$	$B_k + 27$	2	$b_1 - 37.0$ (FA-A)	-	40	6.2	30	$b_1 - 65$		
			$B_k + 7$	$B_k + 27$		$b_1 - 37.5$ (FA-A)					50	5.3	$b_1 - 40$
			$B_k + 7$	$B_k + 27$		$b_1 - 16.5$ (FU)					50	5.3	$b_1 - 40$
UA1555 page 172													
-	50	117 (KR < 200) 200 (KR \geq 200)	$B_k + 5$	$B_k + 25$	2	$b_1 - 43$ (FA)	-	50	6.5	30	$b_1 - 85$		
			$B_k + 5$	$B_k + 25$		$b_1 - 16$ (FU)					22.5	5.3	$b_1 - 40$
			$B_k + 9$	$B_k + 29$		$b_1 - 47$ (FA)					50	6.5	$b_1 - 85$
Glide shoes	53	117 (KR < 200) 200 (KR \geq 200)	$B_k + 9$	$B_k + 29$	2	$b_1 - 47$ (FA)	-	50	6.5	30	$b_1 - 85$		
			$B_k + 9$	$B_k + 29$		$b_1 - 21$ (FU)					22.5	5.3	$b_1 - 40$
			$B_k + 9$	$B_k + 29$		$b_1 - 21$ (FU)					22.5	5.3	$b_1 - 40$
UA1665 page 182													
-	60	117 (KR < 200) 200 (KR \geq 200)	$B_k + 5$	$B_k + 25$	2	$b_1 - 47$ (FA)	-	60	8.5	30	$b_1 - 85$		
			$B_k + 5$	$B_k + 25$		$b_1 - 14$ (FU)					22.5	5.3	$b_1 - 40$
			$B_k + 10$	$B_k + 30$		$b_1 - 52$ (FA)					60	8.5	$b_1 - 85$
Glide shoes	63	117 (KR < 200) 200 (KR \geq 200)	$B_k + 10$	$B_k + 30$	2	$b_1 - 52$ (FA)	-	60	8.5	30	$b_1 - 85$		
			$B_k + 10$	$B_k + 30$		$b_1 - 19$ (FU)					22.5	5.3	$b_1 - 40$
			$B_k + 10$	$B_k + 30$		$b_1 - 19$ (FU)					22.5	5.3	$b_1 - 40$

The designations for dimension A refer to the version of the cable carrier connection.

* Dimension T for leg length support brackets (guiding channel open type for $B_k \geq 90$ mm).

** Dimension Y for guiding channel open for $B_k \geq 90$ mm).

 The cable carrier outer width without attachments B_k is taken into account for calculating the inner width of guide channel b_1 and the overall width B_{kA} .

Type	h ₁ [mm]	h _{KA} [mm]	b ₁ [mm]	B _{KA} [mm]	s [mm]	A [mm]	B [mm]	C [mm]	D [mm]	T* [mm]	Y** [mm]
UA1775 page 194											
–	77	150 (KR < 200) 300 (KR ≥ 200)	B _k + 5	B _k + 25	2	b ₁ – 19.6 (FU)	20	60	8.5	30	b ₁ – 60
Glide shoes	81.5	150 (KR < 200) 300 (KR ≥ 200)	B _k + 10	B _k + 30	2	b ₁ – 24.6 (FU)	20	60	8.5	30	b ₁ – 65
UA1995 page 202/340											
–	110	150 (KR < 200) 300 (KR ≥ 200)	B _k + 6	B _k + 26	2	b ₁ – 28 (FU)	35	60	8.5	30	b ₁ – 60
Glide shoes	116.5	150 (KR < 200) 300 (KR ≥ 200)	B _k + 11	B _k + 31	2	b ₁ – 28 (FU)	35	60	8.5	30	b ₁ – 60

The designations for dimension A refer to the version of the cable carrier connection.

Dimensions

TKK39 series

Type	h ₁ [mm]	h _{KA} [mm]	b ₁ [mm]	B _{KA} [mm]	s [mm]	A [mm]	B [mm]	C [mm]	D [mm]	T [mm]	Y [mm]
TKK39 page 222											
–	50	117	B _k + 5	B _k + 25	2	b ₁ – 43	24	40	5.2	30	b ₁ – 40

The designations for dimension A refer to the version of the cable carrier connection.

K series

When using aluminum hole stays, slide discs have to be placed on the side tabs between cable carrier and channel wall for spacing.

Type	h ₁ [mm]	h _{KA} [mm]	b ₁ [mm]	B _{KA} [mm]	s [mm]	A [mm]	B [mm]	C [mm]	D [mm]	T [mm]	Y [mm]
K0650 page 304											
–	57.5	117 (KR < 200) 200 (KR ≥ 200)	B _k + 5	B _k + 25	2	b ₁ – 19 (FU)	40	30	6.5	30	b ₁ – 65
Slide discs	57.5	117 (KR < 200) 200 (KR ≥ 200)	B _k + 13	B _k + 33	2	b ₁ – 27 (FA) b ₁ – 27 (FU)	40	30	6.5	30	b ₁ – 65
K0900 page 318											
–	78.5	150 (KR < 200) 300 (KR ≥ 200)	B _k + 5	B _k + 25	2	b ₁ – 20.5 (FU)	50	30	6.5	30	b ₁ – 65
Slide discs	78.5	150 (KR < 200) 300 (KR ≥ 200)	B _k + 19	B _k + 39	2	b ₁ – 34.0 (FA) b ₁ – 34.5 (FU)	50	30	6.5	30	b ₁ – 75

The designations for dimension A refer to the version of the cable carrier connection.



MT series

XLT series

ROBOTRAX® System

FLATVEYOR®

CLEANVEYOR®

LS/LSX series

S/SX series

S/SX-Tubes series

Accessories

TRAXLINE®

Dimensions

M series

Type	h ₁ [mm]	h _{KA} [mm]	b ₁ [mm]	B _{KA} [mm]	s [mm]	A [mm]	B [mm]	C [mm]	D [mm]	T [mm]	Y [mm]
M0475 page 364											
Glide shoes	41.5	70 (KR < 100) 125 (KR ≥ 100)	B _k + 4	B _k + 24	2	b ₁ – 39.0 (FI)	24	30	6.5	30	b ₁ – 55
M0650 page 372											
Glide shoes	60.6	117 (KR < 200) 200 (KR ≥ 200)	B _k + 5	B _k + 25	2	b ₁ – 55 (FAI) b ₁ – 24 (FU)	30 22.5	30	6.5	30	b ₁ – 70
Offroad glide shoes	62.2	117 (KR < 200) 200 (KR ≥ 200)	B _k + 5	B _k + 25	2	b ₁ – 55 (FAI) b ₁ – 24 (FU)	30 22.5	30	6.5	30	b ₁ – 65
M0950 page 388											
Glide shoes	83.5	150 (KR < 200) 300 (KR ≥ 200)	B _k + 5	B _k + 25	2	b ₁ – 70.0 (FAI) b ₁ – 19.5 (FU)	40 35	30	8.5	30	b ₁ – 100 b ₁ – 60
Offroad glide shoes	86	150 (KR < 200) 300 (KR ≥ 200)	B _k + 5	B _k + 25	2	b ₁ – 70.0 (FAI) b ₁ – 19.5 (FU)	40 35	30	8.5	30	b ₁ – 100 b ₁ – 60
M1250 page 414											
Glide shoes	99.5	200 (KR < 300) 400 (KR ≥ 300)	B _k + 6	B _k + 26	3	b ₁ – 83 (FAI) b ₁ – 23 (FU)	50 35	30	10.5 11	30	b ₁ – 125 b ₁ – 65
Offroad glide shoes	103	200 (KR < 300) 400 (KR ≥ 300)	B _k + 6	B _k + 26	3	b ₁ – 83 (FAI) b ₁ – 23 (FU)	50 35	30	10.5 11	30	b ₁ – 125 b ₁ – 65
M1300 page 440											
–	120	250 (KR < 320) 400 (KR ≥ 320)	B _k + 6	B _k + 26	3	b ₁ – 27 (FU)	35	30	11	40	b ₁ – 75
Glide shoes	127	250 (KR < 320) 400 (KR ≥ 320)	B _k + 6	B _k + 26	3	b ₁ – 27 (FU)	35	30	11	40	b ₁ – 75

The designations for dimension A refer to the version of the cable carrier connection.



Our engineers will be happy to help with your project planning – please contact us.



The cable carrier outer width without attachments B_k is taken into account for calculating the inner width of guide channel b₁ and the overall width B_{KA}.

Dimensions

XL | XLT series

Type	h ₁ [mm]	h _{KA} [mm]	b ₁ [mm]	B _{KA} [mm]	s [mm]	A [mm]	B [mm]	C [mm]	D [mm]	T [mm]	Y [mm]
XL1650 page 480											
–	140	300 (KR < 350) 400 (KR ≥ 350)	B _k + 6	B _k + 26	3	b ₁ – 99 (FAI)	50	40	13.5	40	b ₁ – 130
Glide shoes	147	300 (KR < 350) 400 (KR ≥ 350)	B _k + 6	B _k + 26	3	b ₁ – 99 (FAI)	50	40	13.5	40	b ₁ – 130

The designations for dimension A refer to the version of the cable carrier connection.

MT series

XLT series

ROBOTRAX® System

FLATVEYOR®

CLEANVEYOR®

LS/LSX series

S/SX series

S/SX-Tubes series

Accessories

TRAXLINE®



The cable carrier outer width without attachments B_k is taken into account for calculating the inner width of guide channel b₁ and the overall width B_{KA}.



Information on the fixing options for the standard channel can be found on page 828

Dimensions

QUANTUM® series

Type	h ₁ [mm]	h _{KA} [mm]	b ₁ [mm]	B _{KA} [mm]	s [mm]	A [mm]	B [mm]	C [mm]	D [mm]	T [mm]	Y [mm]
Q040 page 490											
–	40	70 (KR < 110) 125 (KR ≥ 110)	B _k + 4	B _k + 24	2	b ₁ – 18 (FU)	14	30	6.6	40	b ₁ – 35
Q60 page 496											
Glide shoes	66	117 (KR < 190) 200 (KR ≥ 190)	B _k + 9	B _k + 29	2	b ₁ – 29 (FU)	29	30	6.6	40	b ₁ – 45
Q080 page 506											
Glide shoes	88	150 (KR < 200) 300 (KR ≥ 200)	B _k + 13	B _k + 33	2	b ₁ – 38 (FU)	35	40	9	40	b ₁ – 70
Q100 page 520											
Glide shoes	108	250 (KR < 300) 400 (KR ≥ 300)	B _k + 13	B _k + 33	2	b ₁ – 43 (FU)	35	40	11	40	b ₁ – 105

The designations for dimension A refer to the version of the cable carrier connection.

TKA series

Type	h ₁ [mm]	h _{KA} [mm]	b ₁ [mm]	B _{KA} [mm]	s [mm]	A [mm]	B [mm]	C [mm]	D [mm]	T [mm]	Y [mm]
TKA30 page 574											
–	29.15	70 (KR < 95) 125 (KR ≥ 95)	B _k + 4	B _k + 24	2	b ₁ – 31 (FU)	–	50	6.5	–	–
TKA38 page 580											
–	36.75	70 (KR < 95) 125 (KR ≥ 95)	B _k + 4	B _k + 24	2	b ₁ – 10.5 (FU)	–	50	4.5	25	b ₁ – 55
TKA45 page 586											
–	51	117 (KR < 200) 200 (KR ≥ 200)	B _k + 5	B _k + 25	2	b ₁ – 12 (FU)	–	50	5.5	25	b ₁ – 60
TKA55 page 594											
–	65	117 (KR < 200) 200 (KR ≥ 200)	B _k + 5	B _k + 25	2	b ₁ – 16 (FU)	–	60	5.5	25	b ₁ – 75

The designations for dimension A refer to the version of the cable carrier connection.



The cable carrier outer width without attachments B_k is taken into account for calculating the inner width of guide channel b₁ and the overall width B_{KA}.

Dimensions

UAT series

Type	h ₁ [mm]	h _{KA} [mm]	b ₁ [mm]	B _{KA} [mm]	s [mm]	A [mm]	B [mm]	C [mm]	D [mm]	T [mm]	Y [mm]
UAT1555 page 606											
–	69	117 (KR ≤ 200) 200 (KR ≥ 200)	B _k + 5	B _k + 25	2	b ₁ – 15 (FU)	25 40	40	5.5	30	b ₁ – 80

The designations for dimension A refer to the version of the cable carrier connection.

S/SX series | S/SX tubes

Type	h ₁ [mm]	h _{KA} [mm]	b ₁ [mm]	B _{KA} [mm]	s [mm]	A [mm]	B [mm]	C [mm]	D [mm]	T [mm]	Y [mm]
S/SX 0650 page 726											
Glide shoes	56	125 (KR ≤ 155) 200 (KR > 155)	B _k + 10	B _k + 30	2	b ₁ – 47	45	15	6.4	30	b ₁ – 70
S/SX 0950 page 736											
Glide shoes	73	150 (KR ≤ 200) 300 (KR > 200)	B _k + 14	B _k + 34	2	b ₁ – 77	65	20	8.4	30	b ₁ – 100
S/SX 1250 page 748											
Glide shoes	99	200 (KR ≤ 300) 400 (KR > 300)	B _k + 12	B _k + 32	3	b ₁ – 76	80	25	10.5	30	b ₁ – 100
Offroad glide shoes	104	200 (KR ≤ 300) 400 (KR > 300)	B _k + 12	B _k + 32	3	b ₁ – 76	80	25	10.5	50	b ₁ – 100
S/SX 1800 page 772											
Glide shoes	155	300 (KR ≤ 435) 500 (KR > 435)	B _k + 17	B _k + 37	3	b ₁ – 94	115	30	13	50	b ₁ – 120

The designations for dimension A refer to the version of the cable carrier connection.



Standard fixing with angle brackets (standard)

The angle brackets are mounted at the joints, ensuring precise connection of the joint areas in addition to fixing the channel to the substructure.

- Optimum alignment of the joints
- Reduced installation times
- Minimum number of screw connections
- Reliable fixing, even under rough conditions

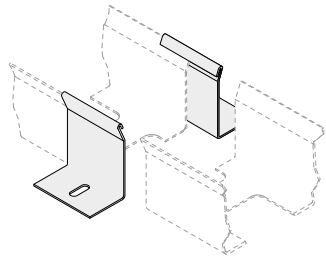
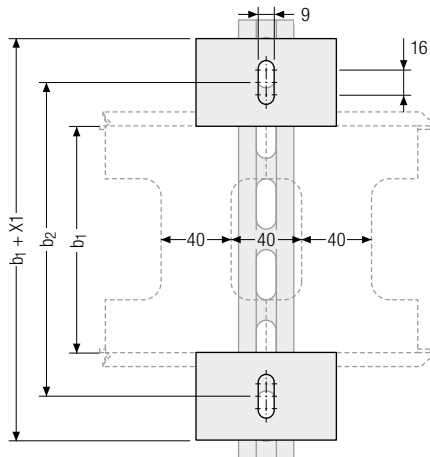
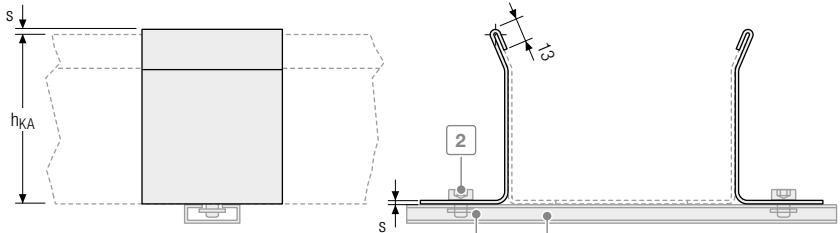

 The figure shows an open channel version

s [mm]	X1 [mm]	b ₂ [mm]
2	104	b ₁ + 54
3	106	b ₁ + 56

 The sheet metal thickness "s" corresponds to the respective wall thickness "s" of the channel.

 As a standard, the angle brackets included with the delivery are installed on all joints as well as at both ends of a channel. If you require more angle brackets beyond this, please state this when ordering.

Calculating C-profile length

Suitable perforated C-profiles can be found from page 865

C-profile length L_p

$$L_p = b_1 + 106$$

C-profile length L_p rounded to 50 mm

Fixing kit (optional)

The delivery scope of the standard channel does not include the optional joining clamp fixing kit.

Fixing kit

1 C-rail (length depends on b_1)

2 Hexagon socket screws

3 Slide nut

 The length of the C-rail depends on the channel width and is supplied in standard lengths. Please contact us if you require custom lengths.

Fixing with alignment flanges and floor fixing plate

The fixing tabs are mounted at the joints, ensuring precise connection of the joint areas in addition to fixing the channel to the substructure.

- Optimum alignment of the joints
- Minimum number of screw connections
- Reduced installation times
- Push-to-connect system

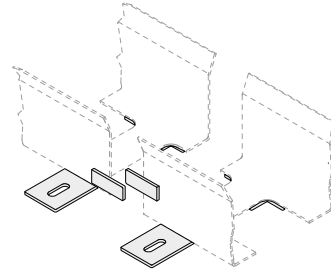

C-profile length L_P

C-profile length L_P
rounded to 50 mm

$$L_P = b_1 + 105$$

Fixing with floor fixing bracket

The floor fixing brackets are mounted at the joints, ensuring precise connection of the joint areas in addition to fixing the channel to the substructure.

- Easy alignment of the joints
- Minimized number of screw connections
- Reduced installation times

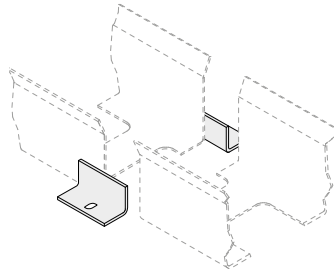

C-profile length L_P

C-profile length L_P
rounded to 50 mm

$$L_P = b_1 + 66$$

Fixing with lateral connecting flange

The unsupported connecting flanges are mounted at the joints, ensuring precise connection of the joint areas in addition to fixing the channel to the substructure.

- Unsupported joints without support (self supporting)
- Reliable, secure connection even with extreme vibrations or in unsupported channel arrangements

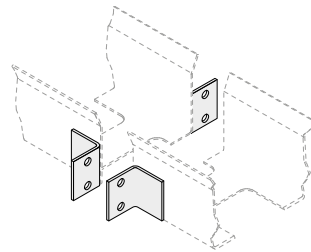

Order

Standard channel

To order the standard channel, please provide the following information:

- Number of guide channels
- Total length of channel
- Slide support height h_1
- Material
- Slide support length L_{KA}
- Outer height of guide channel h_{KA}
- Version of guide channel
- Floor fixing
- inner width of guide channel b_1
- Part length
- Join connection

MT series

XLT series

ROBOTRAX® System

FLATVEYOR®

CLEANVEYOR®

LS/LSX series

S/SX series

S/SX-Tubes series

Accessories

TRAXLINE®

Guide channels in the modular system

- Modular system with optimized design for long travel lengths.
- Easy installation.
- Available in zinc plated sheet steel or stainless steel.

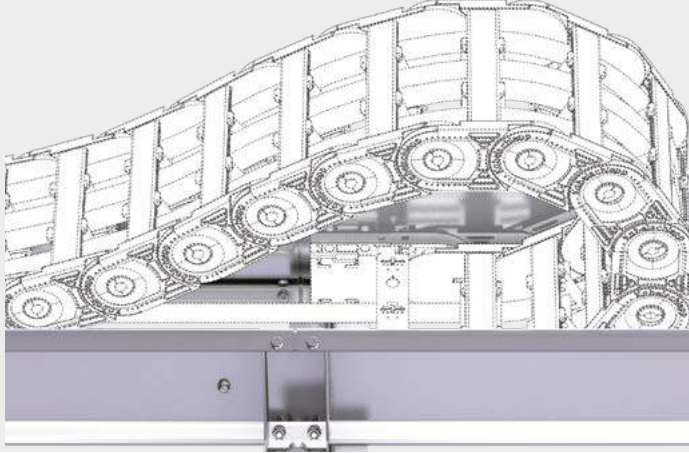

Zinc plated sheet steel /
stainless steel



Standard lengths 1000 / 2000 mm
Special lengths on request

Features

- Especially suitable for cranes and applications with long travel lengths
- Simple design for short installation times
- No accumulation of dirt through open construction
- Fast and easy installation thanks to pre-assembled sidebands and channel brackets
- Complete system for screw-fitting
- All components without welds

MT
seriesXLT
seriesROBOTRAX®
System

FLATVEYOR®

CLEANVEYOR®

LS/LSX
seriesS/SX
seriesS/SX-Tubes
series

Accessories

TRAXLINE®

One-sided arrangement

For one-sided arrangement of the cable carrier, the cable carrier slides behind the fixed point on a continuous slide support with run-off bevels.

Open design

Channel profile with and without slide supports incl. run-on bevels.

Dirt and liquids can drop through without restrictions.



Opposite arrangement

For opposite arrangement, a slide support is also attached for bridging between the fixed point connections.

Open design

Channel profile with and without slide supports incl. run-on bevels.

Dirt and liquids can drop through without restrictions.

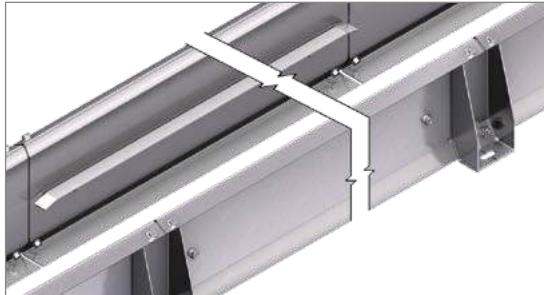

MT series
XLT series
ROBOTRAX® System
FLATVEYOR®
CLEANVEYOR®
LS/LSX series
S/SX series
S/SX-Tubes series
Accessories
TRAXLINE®

Dimensions

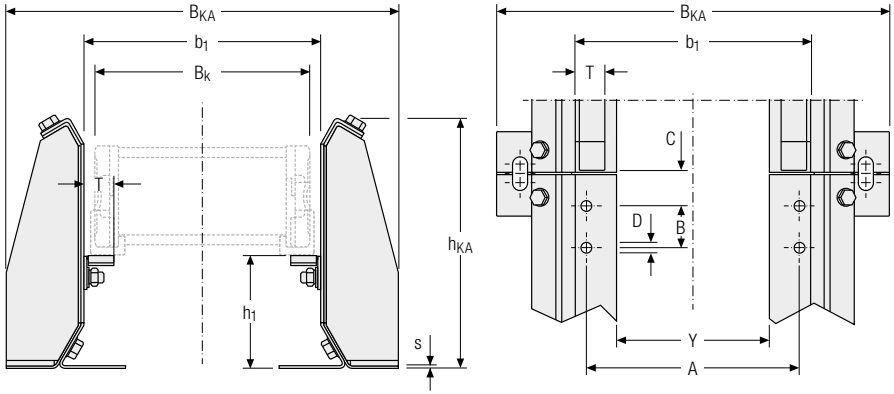

Dimensions

UNIFLEX Advanced

Type	h_1 [mm]	h_{KA} [mm]	b_1 [mm]	B_{KA} [mm]	s [mm]	A [mm]	B [mm]	C [mm]	D [mm]	T [mm]	Y [mm]
UA1555 page 172											
Glide shoes	53	124	$B_k + 9$	$B_k + 139$	2	$b_1 - 47$ (FA) $b_1 - 21$ (FU)	— 22.5	25 22.5	6.4 5.5	24	$b_1 - 69$
UA1665 page 182											
Glide shoes	63.5	124 (KR < 200) 176 (KR ≥ 200)	$B_k + 10$	$B_k + 140$	2	$b_1 - 52$ (FA) $b_1 - 19$ (FU)	— 22.5	30.5 25	8.4 5.5	24 25	$b_1 - 69$ $b_1 - 66$
UA1775 page 194											
Glide shoes	83.5	176 (KR < 200) 209 (KR ≥ 200)	$B_k + 10$	$B_k + 140$	2	$b_1 - 52$ (FA) $b_1 - 19$ (FU)	20	30	8.5	25	$b_1 - 66$ $b_1 - 70$
UA1995 page 202/340											
Glide shoes	116.5	258	$B_k + 11$	$B_k + 141$	2	$b_1 - 28$ (FU)	35	30	8.5	50	$b_1 - 100$

M series

Type	h_1 [mm]	h_{KA} [mm]	b_1 [mm]	B_{KA} [mm]	s [mm]	A [mm]	B [mm]	C [mm]	D [mm]	T [mm]	Y [mm]
M0650 page 372											
Glide shoes	60.5	124 (KR < 200) 176 (KR ≥ 200)	$B_k + 5$	$B_k + 135$	2	$b_1 - 55$ (FA)	30	25	6.4	24	$b_1 - 69$
Offroad glide shoes	63.5	124 (KR < 200) 176 (KR ≥ 200)	$B_k + 5$	$B_k + 135$	2	$b_1 - 24$ (FU)	22.5	30.5	6.5	25	$b_1 - 66$



The cable carrier outer width without attachments B_k is taken into account for calculating the inner width of guide channel b_1 and the overall width B_{KA} .



The dimension A refers only to the connection holes.

Dimensions

M series

Type	h ₁ [mm]	h _{KA} [mm]	b ₁ [mm]	B _{KA} [mm]	s [mm]	A [mm]	B [mm]	C [mm]	D [mm]	T [mm]	Y [mm]
M0950 page 388											
Glide shoes	83.5	176 (KR < 200) 209 (KR ≥ 200)	B _k + 5	B _k + 135	2	b ₁ – 70 (FAI)	40	30	8.4	25	b ₁ – 66
Offroad glide shoes	86.5					b ₁ – 19.5 (FU)	35	34.5	8.5		b ₁ – 70
M1250 page 414											
Glide shoes	99.5	209 (KR < 300) 258 (KR ≥ 300)	B _k + 6	B _k + 136	2	b ₁ – 83 (FAI)	50	35	10.5	50	b ₁ – 70
Offroad glide shoes	103					b ₁ – 23 (FU)	35	40.5	11		b ₁ – 90
M1300 page 440											
Glide shoes	127.5	258	B _k + 6	B _k + 136	2	b ₁ – 27 (FU)	35	30	11	50	b ₁ – 90

S/SX series

Type	h ₁ [mm]	h _{KA} [mm]	b ₁ [mm]	B _{KA} [mm]	s [mm]	A [mm]	B [mm]	C [mm]	D [mm]	T [mm]	Y [mm]
S/SX0650 page 726											
Glide shoes	56	124	B _k + 10	B _k + 140	2	b ₁ – 47 (FAI)	45	25	6,4	24	b ₁ – 69
S/SX0950 page 736											
Glide shoes	73	176	B _k + 10	B _k + 140	2	b ₁ – 77 (FAI)	65	30	8,4	27	b ₁ – 66
S/SX1250 page 748											
Offroad glide shoes	103	209 (KR < 350) 258 (KR ≥ 350)	B _k + 12	B _k + 142	2	b ₁ – 76 (FAI)	80	35	10,5	50	b ₁ – 100
S/SX1252 page 748											
Offroad glide shoes	103	209 (KR < 350) 258 (KR ≥ 350)	B _k + 12	B _k + 142	2	b ₁ – 76 (FAI)	80	35	10,5	50	b ₁ – 100



The cable carrier outer width without attachments B_k is taken into account for calculating the inner width of guide channel b₁ and the overall width B_{KA}.

MT series

XLT series

ROBOTRAX® System

FLATVEVOR®

CLEANVEVOR®

LS/LSX series

S/SX series

S/SX-Tubes series

Accessories

TRAXLINE®

Fixing with channel brackets

The channel brackets are mounted at the joins, ensuring precise connection of the joins in addition to fixing the channel to the substructure.

- Optimum alignment of the joins
- Reduced installation times
- No welds
- Minimum number of screw connections
- Reliable fixing under rough conditions
- High stability

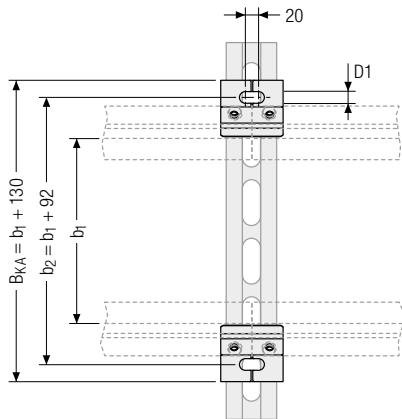
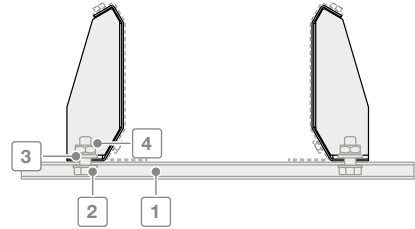
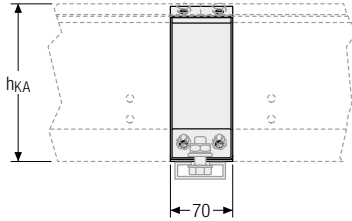

h_{KA} [mm]	$D1$ [mm]	s [mm]
123	11	2
175	11	2
208	11	2
257	11	2

 The sheet metal thickness "s" corresponds to the respective wall thickness "s" of the channel.

 As a standard, the channel brackets included with the delivery are installed on all joins as well as at both ends of a channel. If you require more channel brackets beyond this, please state this when ordering.

Calculating C-profile length

Suitable perforated C-profiles can be found from page 865

C-profile length L_P

$$L_P = B_{KA} + 50 \text{ mm}$$

C-profile length L_P rounded to 50 mm

Fixing material (optional)

The delivery scope of the Steel Guide System (TKSG) does not include the optional joining clamp fixing kit.

Fixing material

- 1 C-rail (length depends on b_1)
- 2 T-head bolt M10
- 3 Hex nut
- 4 Washer

Order

To order the Steel Guide System (TKSG), please provide the following information:

- Number of guide channels
- Total length of channel
- Support length L_{KA}
- Outer height of guide channel h_{KA}
- Inner width of guide channel b_1
- Material
- Support height h_1
- Delivery (unmounted/mounted)
- Fixing with or without C-profile

Cover for guide channels



Protection against external influences: Maintenance-friendly enclosure

- Easy inspection of the cable carrier.
- Openable at any position.
- Protection of the cable carrier system against external influences (coarse dirt, falling parts, snow, ice).
- Disassembly without screws.
- To open without tools.
- Secured against accidental closing in opening position.
- Can be used with any TSUBAKI KABELSCHLEPP channel system.
- Modular design.



MT series

XLT series

ROBOTRAX® System

FLATVEYOR®

CLEANVEYOR®

LS/LSX series

S/SX series

S/SX-Tubes series

Accessories

TRAXLINE®



Our engineers will be happy to help with your project planning – please contact us.

Aluminium guide channels in the modular system

- Modular system with many mounting options.
- Standard lengths and sets.
- Lightweight design for high speeds.
- Slide and roller support made of high-quality plastic.

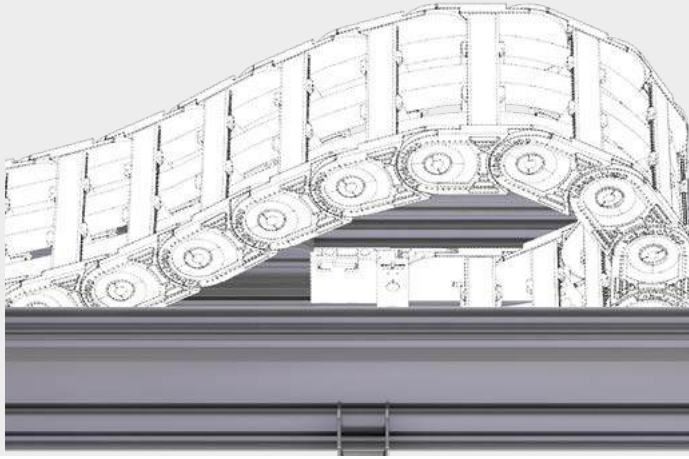

Channel side wall
Al alloy



Standard lengths 1000 / 2000 mm
Special lengths on request

Features

- Safe operation on long travel length
- Seawater resistant
- Twin channel connectors for parallel arrangement of several channels
- Standard- and Heavy-Duty-Version
- Variable fixation in standard stainless steel
- UMB mounting kit for assembly of the cable carrier

The Alu Guide System (TKAL) for long travel applications and high loads ensures secure guidance and smooth running of the energy chain in a gliding and rolling application.

The standardized channel profiles of 1000 / 2000 mm in length can be individually adjusted to the width of the chain. They can be quickly and easily be installed with the help of a mounting kit. Such UMB mounting kits are also available for attaching the fixed-point of the energy chain.

The optional damping band additionally reduces noise emission and guarantees an even quieter running of the chain.

TSUBAKI KABELSCHLEPP also offer the Alu Guide System (TKAL) together with the appropriate energy chain as well as with the ready-to-install TOTALTRAX® System including cables.



Assembly instruction

One-sided arrangement

For One-sided arrangement of the cable carrier, the cable carrier slides behind the fixed point on a slide support with run-on bevels.

Open design

Channel with and without supports incl. run-on bevels.

Dirt and water can drop through without restrictions.



Opposite arrangement

For opposite arrangement, a slide support with a minimum length of 500 mm is also attached for bridging between the fixed point connections.

Open design

Channel with and without supports incl. run-on bevels.

Dirt and water can drop through without restrictions.



Glide and roll support made of plastic

Glide support

- Simple and quick mounting by hooking in
- Slip-free hold in channel fastening groove
- 500 mm long, loadable up to 100 kg
- Compensation of linear expansion by tothing at the joints – continuous glide surface
- Optimized, rounded approach slope without bend



Roll support (TKAL 254/274)

- Simple and quick mounting by hooking in
- Slip-free hold in channel fastening groove
- 500 mm long, loadable up to 100 kg
- Compensation of linear expansion by tothing at the joints – continuous roll surface
- Minimal noise emission



MT series

XLT series

ROBOTRAX® System

FLATVEVOR®

CLEANVEVOR®

LS/LSX series

S/SX series

S/SX-Tubes series

Accessories

TRAXLINE®

Dimensions

TKAL 134

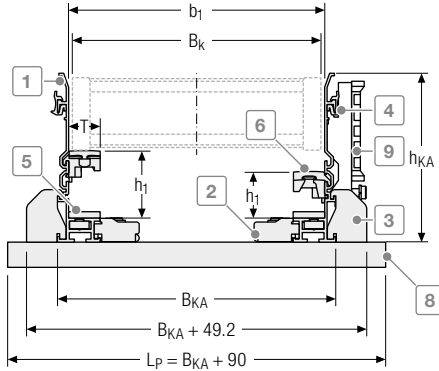

- 1 Channel profile
- 2 Internal mounting kit
- 3 External mounting kit
- 4 Joint connectors
- 5 Damping band (optional)
- 6 Stable gliding support made of plastic
- 7 Stable roller support made of plastic
- 8 C-Rail
- 9 Strain relief holder kit

 Using holder inside double-sided
 b_1 min.: 118 mm.
 Using holder outside double-sided
 b_1 min.: 50 mm.

TKAL 195

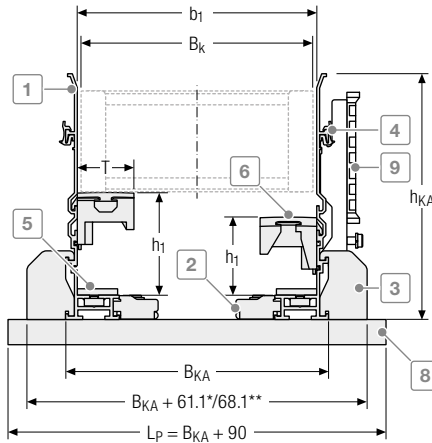

- 1 Channel profile
- 2 Internal mounting kit
- 3 External mounting kit
- 4 Joint connectors
- 5 Damping band (optional)
- 6 Stable gliding support made of plastic
- 7 Stable roller support made of plastic
- 8 C-Rail
- 9 Strain relief holder kit

 Using holder inside double-sided
 b_1 min.: 134 mm.
 Using holder outside double-sided
 b_1 min.: 90 mm.

* for C-profiles 3938/3939 ** for C-profiles 3940/3941

 As a standard, the mounting kits included with the delivery are installed on all joins as well as at both ends of a channel. If you require more angle brackets beyond this, please state this when ordering.

Dimensions

TKAL 254

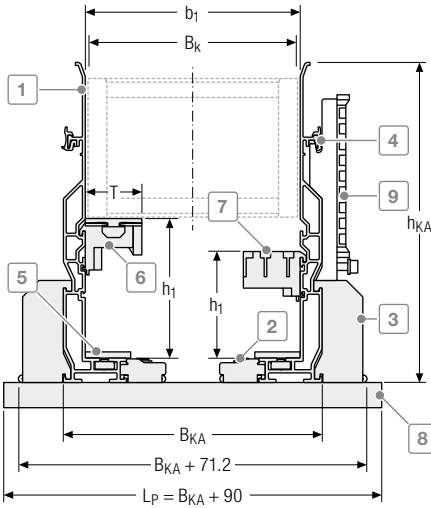

- 1 Channel profile
- 2 Internal mounting kit
- 3 External mounting kit
- 4 Joint connectors
- 5 Damping band (optional)
- 6 Stable gliding support made of plastic
- 7 Stable roller support made of plastic
- 8 C-Rail
- 9 Strain relief holder kit

 Using holder inside double-sided
 b_1 min.: 134 mm.
 Using holder outside double-sided
 b_1 min.: 90 mm.

TKAL 274

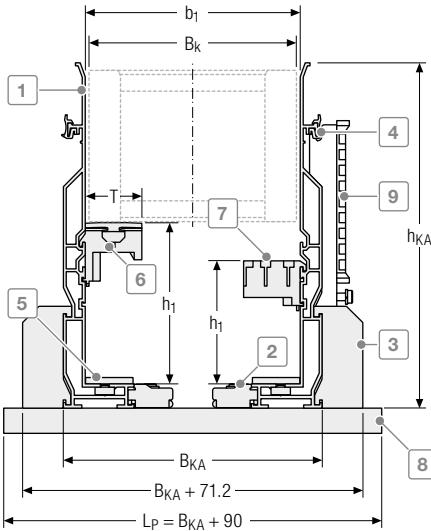

- 1 Channel profile
- 2 Internal mounting kit
- 3 External mounting kit
- 4 Joint connectors
- 5 Damping band (optional)
- 6 Stable gliding support made of plastic
- 7 Stable roller support made of plastic
- 8 C-Rail
- 9 Strain relief holder kit

 Using holder inside double-sided
 b_1 min.: 146 mm.
 Using holder outside double-sided
 b_1 min.: 90 mm.

 As a standard, the mounting kits included with the delivery are installed on all joins as well as at both ends of a channel. If you require more angle brackets beyond this, please state this when ordering.

UNIFLEX *Advanced series*

Type	Channel type	h ₁ [mm]	h _{KA} [mm]	b ₁ [mm]	b ₂ [mm]	b ₃ [mm]	B _{KA} [mm]	T [mm]
UA1455 page 162								
Glide shoes	134	40	134	B _k + 7	B _k + 50	B _k - 69	B _k + 25	25
UA1555 page 172								
Glide shoes	134	53	134	B _k + 9	B _k + 52	B _k - 67	B _k + 27	25
UA1665 page 182								
Glide shoes	195	61,5	195	B _k + 10	B _k + 60,15	B _k - 82,4	B _k + 28,6	45
UA1775 page 194								
Glide shoes	195	81	195	B _k + 9	B _k + 59,15	B _k - 83,4	B _k + 27,6	45
UA1995 page 202								
Glide shoes	254	116	254	B _k + 10,4	B _k + 71,9	B _k - 81	B _k + 45	45

K series

Type	Channel type	h ₁ [mm]	h _{KA} [mm]	b ₁ [mm]	b ₂ [mm]	b ₃ [mm]	B _{KA} [mm]	T [mm]
K0650 page 304								
-	134	56,5	134	B _k + 5	B _k + 48	B _k - 71	B _k + 23	25
Slide discs	134	56,5	134	B _k + 13	B _k + 56	B _k - 63	B _k + 31	25
K0900 page 318								
-	195	81	195	B _k + 5	B _k + 55,15	B _k - 87,4	B _k + 23,6	25
Slide discs	195	81	195	B _k + 19	B _k + 69,15	B _k - 73,4	B _k + 37,6	45

M series

Type	Channel type	h ₁ [mm]	h _{KA} [mm]	b ₁ [mm]	b ₂ [mm]	b ₃ [mm]	B _{KA} [mm]	T [mm]
M0650 page 372								
Glide shoes	195	61,5	195	B _k + 5	B _k + 55,15	B _k - 87,4	B _k + 23,6	45
Offroad glide shoes	195	61,5	195	B _k + 5	B _k + 55,15	B _k - 87,4	B _k + 23,6	45
M0950 page 388								
Offroad glide shoes	195	86	195	B _k + 5	B _k + 55,15	B _k - 87,4	B _k + 23,6	45
M1250 page 414								
Offroad glide shoes	274	103	274	B _k + 6	B _k + 67,5	B _k - 97,4	B _k + 40,6	45
M1300 page 440								
Glide shoes	274	127,5	274	B _k + 6	B _k + 67,5	B _k - 97,4	B _k + 40,6	45



The cable carrier outer width without attachments B_k is taken into account for calculating the inner width of guide channel b₁ and the overall width B_{KA}.



Our engineers will be happy to help with your project planning – please contact us.

QUANTUM® series

Type	Channel type	h ₁ [mm]	h _{KA} [mm]	b ₁ [mm]	b ₂ [mm]	b ₃ [mm]	B _{KA} [mm]	T [mm]
Q040 page 490								
–	134	40	134	B_k + 4	B _k + 47	B _k – 72	B _k + 22	25
Q060 page 496								
Glide shoes	195	66.5	195	B_k + 9	B _k + 59.15	B _k – 83.4	B _k + 27.6	45
Q080 page 506								
Glide shoes	195	86	195	B_k + 13	B _k + 63.15	B _k – 79.4	B _k + 31.6	45
Q100 page 520								
Glide shoes	274	108	274	B_k + 13	B _k + 74.5	B _k – 90.4	B _k + 47.6	45

TKA series

Type	Channel type	h ₁ [mm]	h _{KA} [mm]	b ₁ [mm]	b ₂ [mm]	b ₃ [mm]	B _{KA} [mm]	T [mm]
TKA38 page 580								
–	134	36.5	134	B_k + 4	B _k + 47	B _k – 72	B _k + 22	25
TKA45 page 586								
–	134	53	134	B_k + 5	B _k + 48	B _k – 71	B _k + 23	25
TKA55 page 594								
–	195	66.5	195	B_k + 5	B _k + 55.15	B _k – 87.4	B _k + 23.6	45

UAT series

Type	Channel type	h ₁ [mm]	h _{KA} [mm]	b ₁ [mm]	b ₂ [mm]	b ₃ [mm]	B _{KA} [mm]	T [mm]
UAT1555 page 606								
–	195	66.5	195	B_k + 5	B _k + 55.15	B _k – 87.4	B _k + 23.6	45



The cable carrier outer width without attachments B_k is taken into account for calculating the inner width of guide channel b₁ and the overall width B_{KA}.



Our engineers will be happy to help with your project planning – please contact us.

Standard and heavy duty

The internal or external mounting kits made of stainless steel are mounted at the joints, ensuring precise connection of the joints in addition to fastening the channel to the substructure.

Flying joint

The internal and external mounting kits made of stainless steel are mounted with a spacing of 30-500 mm from the joints, ensuring fastening of the channel to the substructure. The mounting kit does not necessarily have to be mounted at the joints.

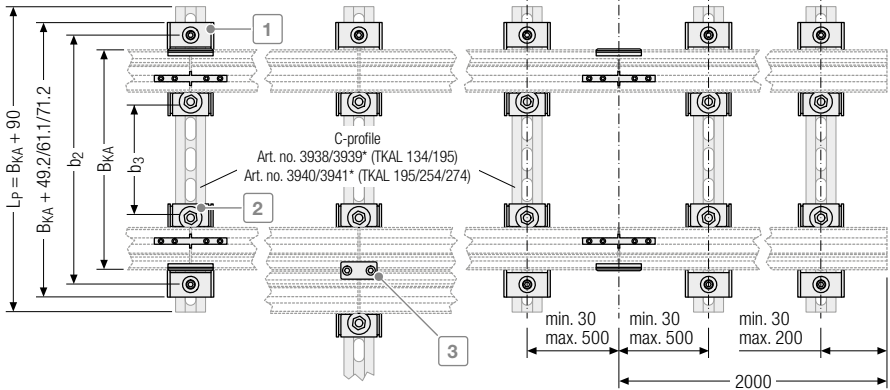

External mounting kit 1

The mounting brackets are mounted at the outside of the channel. The additional joint connectors ensure precise connection of the joints.

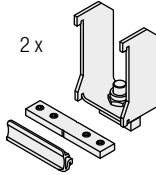

Internal mounting kit 2

The mounting brackets are mounted at the inside of the channel. The additional joint connectors ensure precise connection of the joints.

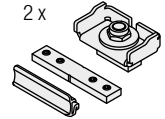

UMB mounting kit

The UMB mounting kit for fixed point ensures optimum fastening of the cable carrier in the channel and depends on the cable carrier type.

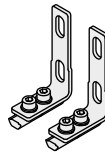

Holder set strain relief (optional)

The holders are mounted on the outside of the channel for fixed installation of cables.

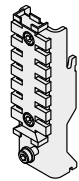

Twin channel connector 3 (optional)

The twin channel connectors enable the parallel arrangement of several channels.



 All pictures of the mounting kit are exemplary.

Order

To order the Alu Guide System, please provide the following information or the used cable carrier:

- Number of guide channels
- Total length of channel
- Support length L_{KA} '
- Type of fastening (internal/external)
- Delivery (unmounted/mounted)
- Support height h_1
- Fixing with C-profile
- Inner width of guide channel b_1

* More information can be found on page 865



Subject to change without notice.

MT
series

XLT
series

ROBOTRAX®
System

FLATVEYOR®

CLEANVEYOR®

LS/LSX
series

S/SX
series

S/SX-Tubes
series

Accessories

TRAXLINE®

Guide channels for multifunctional use

- Flexible use in many areas of application.
- Made of zinc plated sheet steel or stainless steel.
- Easy and fast horizontal or vertical arrangement.
- On its side laying installation possible.

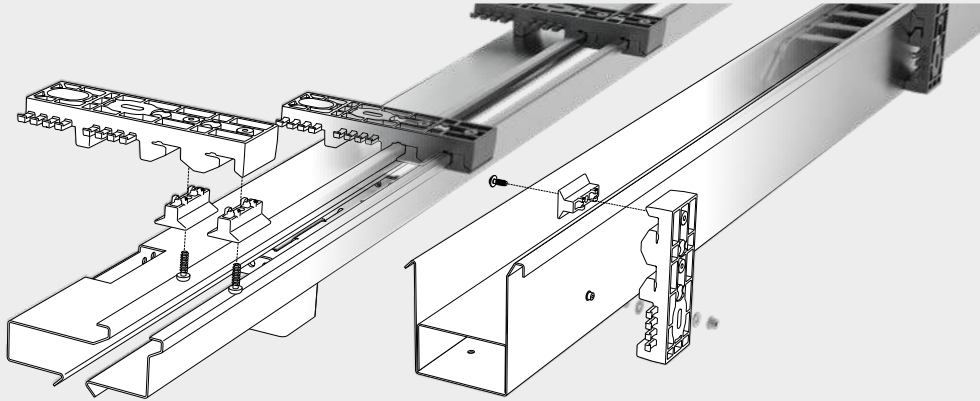

Zinc plated sheet steel or stainless steel



Standard lengths 2000 mm
Special lengths on request

Features

- Space-saving design
- Installation possible horizontal or laying on its side
- Easy and fast assembly by only one fitter
- Saves additional cable channels through installation of permanent cables directly on the holder (securely behind the channel)
- System remains horizontally adjustable after installation
- Mounting holes for the cable carriers and cable ducts every 850 mm
- Brackets are installed with screws or weld studs
- No complex steel structure necessary
- Suitable for all I-beams and box beams
- The same mounting brackets for different trough sizes/chain types
- Can be installed "flying"
- Closed design
 - Guiding for suspended chains
 - Allows operation of the cable carrier laying on its side
 - Mechanical protection
 - Protection against lateral acceleration
 - Protection against the cable carrier "banging" during acceleration and deceleration

With magnets as mounting aids for easy positioning of the holder and placing of the fastenings such as drilled holes or welded studs.

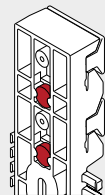

Our engineers will be happy to help with your project planning – please contact us.

One-sided arrangement with central feed

For single-sided arrangement of the cable carrier with central feed, the cable carrier slides behind the fixed point on a continuous slide plate.

Closed design – standing without enclosure (Variant A)

One-part channel in version with open top and one-part slide plate.

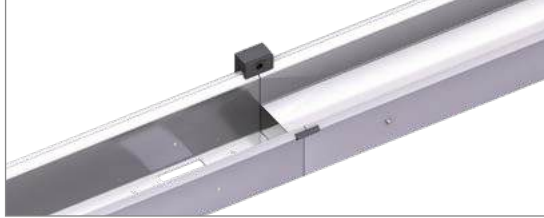

Closed design – standing with enclosure (Variant B)

One-part channel in version with closed top (enclosure) and one-part slide plate.

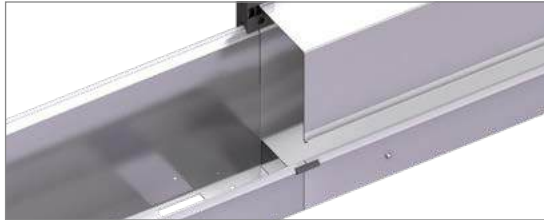

 For central feed, permanent cables can be placed directly on the holder (securely behind the channel)

One-sided arrangement with end feed

For single-sided arrangement of the cable carrier with end feed, the cable carrier slides behind the fixed point on itself.

Closed design – standing without enclosure (Variant A)

One-part channel in version with open top and one-part slide plate.



Closed design – standing with enclosure (Variant B)

One-part channel in version with closed top (enclosure) and one-part slide plate.



MT series
XLT series
ROBOTRAX® System
FLATVEYOR®
CLEANVEYOR®
LS/LSX series
S/SX series
S/SX-Tubes series
Accessories
TRAXLINE®

Opposite arrangement

For opposite arrangement, a slide support is also attached for bridging between the fixed point connections.

Closed design – standing without enclosure (Variant A)

One-part channel in version with open top and one-part slide plate.

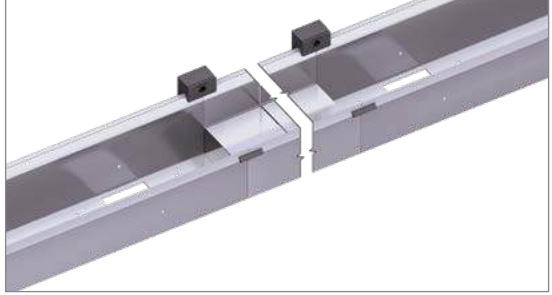

Closed design – standing with enclosure (Variant B)

One-part channel in version with closed top (enclosure) and one-part slide plate.

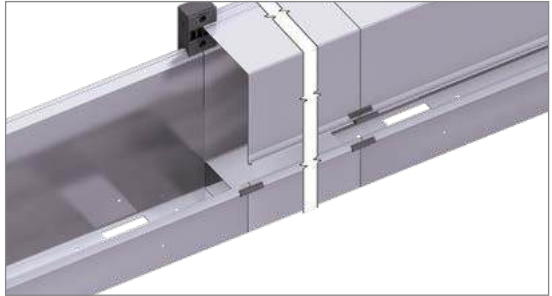

Closed design – laying on its side with enclosure (Variant C)

One-part channel laying on its side in enclosed version (enclosure) incl. driver sledge.

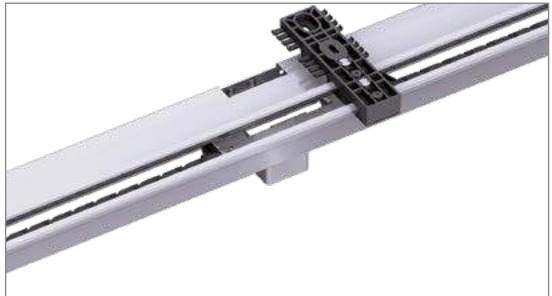

MT series

XLT series

ROBOTRAX® System

FLATVEYOR®

CLEANVEYOR®

LS/LSX series

S/SX series

S/SX-Tubes series

Accessories

TRAXLINE®



MT
series

XLT
series

ROBOTRAX®
System

FLATVEYOR®

CLEANVEYOR®

LS/LSX
series

S/SX
series

S/SX-Tubes
series

Accessories

TRAXLINE®

Dimensions | standing without enclosure (Variant A)

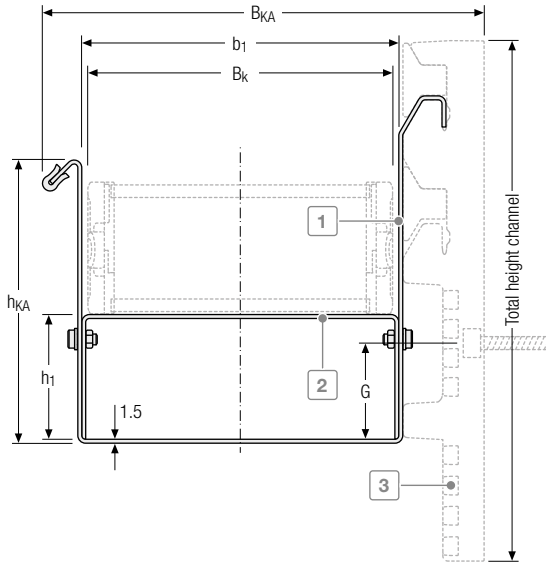

- 1 Guide channel
- 2 Stable gliding support made of zinc plated sheet steel or stainless steel
- 3 Holder

Slide support height

$$h_1 = h_G$$

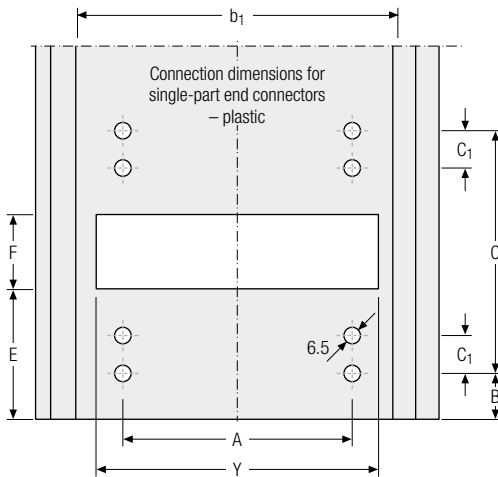

QuickTrax® series

B _i [mm]	KR [mm]	h ₁ [mm]	h _{KA} [mm]	Total height channel [mm]	b ₁ [mm]	B _{KA} [mm]	A [mm]	B [mm]	C [mm]	C ₁ [mm]	E [mm]	F [mm]	G [mm]	Y [mm]
QT0320 with channel holder 202 page 138														
25	75	25.5	54	202	42	90.7	10	79	140	14	129	40	39	27
50	100				67									115.7
QT0320 with channel holder 155 page 138														
25	75	25.5	54	156.5	42	90.7	10	79	140	14	129	40	39	27
50	100				67									115.7

EasyTrax® series

B _i [mm]	KR [mm]	h ₁ [mm]	h _{KA} [mm]	Total height channel [mm]	b ₁ [mm]	B _{KA} [mm]	A [mm]	B [mm]	C [mm]	C ₁ [mm]	E [mm]	F [mm]	G [mm]	Y [mm]
ET0320 with channel holder 202 page 250														
25	75	25.5	54	202	42	90.7	10	79	140	14	129	40	39	27
50	100				67									115.7
ET0320 with channel holder 155 page 250														
25	75	25.5	54	156.5	42	90.7	10	79	140	14	129	40	39	27
50	100				67									115.7

MT series

XLT series

ROBOTRAX® System

FLATVEYOR®

CLEANVEYOR®

LS/LSX series

S/SX series

S/SX-Tubes series

Accessories

TRAXLINE®

 The cable carrier outer width without attachments B_k is taken into account for calculating the inner width of guide channel b₁ and the overall width B_{KA}.

 Information on the fixing options for the Easy Guide Systems can be found on page 863

Dimensions | standing without enclosure (Variant A)

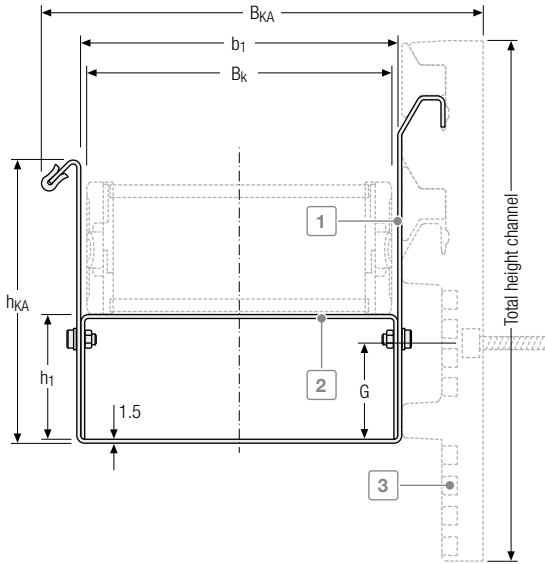

- 1 Guide channel
- 2 Stable gliding support made of zinc plated sheet steel or stainless steel
- 3 Holder

Slide support height

$$h_1 = h_G$$

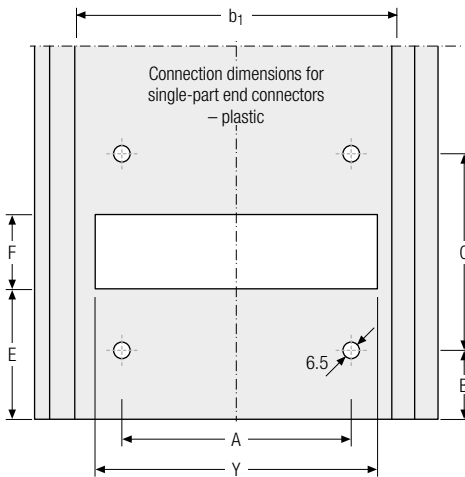

UNIFLEX *Advanced series*

B _i [mm]	KR [mm]	h ₁ [mm]	h _{KA} [mm]	Total height channel [mm]	b ₁ [mm]	B _{KA} [mm]	A [mm]	B [mm]	C [mm]	E [mm]	F [mm]	G [mm]	Y [mm]
UA1455 with channel holder 202 page 162													
58					79	127.7	43.5						64
78	125	36	100	202	99	147.7	63.5	73	152	123	52	39	84
103					124	172.7	88.5						109
UA1455 with channel holder 155 page 162													
58					79	127.7	43.5						64
78	125	36	100	156.5	99	147.7	63.5	73	152	123	52	39	84
103					124	172.7	88.5						109
UA1555 with channel holder 202 Seite 172													
50					73	121.7	30						58
75	125	50	115	202	98	146.7	55	61	176	111	76	39	83
100					123	171.7	80						108
UA1555 with channel holder 155 page 172													
50					73	121.7	30						58
75	125	50	115	156.5	98	146.7	55	61	176	111	76	39	83
100					123	171.7	80						108

 Standard version of the cable carrier in the Easy Guide System without glide shoes.

MT series

XLT series

ROBOTRAX® System

FLATVEYOR®

CLEANVEYOR®

LS/LSX series

S/SX series

S/SX-Tubes series

Accessories

TRAXLINE®

 The cable carrier outer width without attachments B_k is taken into account for calculating the inner width of guide channel b₁ and the overall width B_{KA}.

 Our engineers will be happy to help with your project planning – please contact us.

 Information on the fixing options for the Easy Guide Systems can be found on page 863

Dimensions | Ground holder (Variant A)

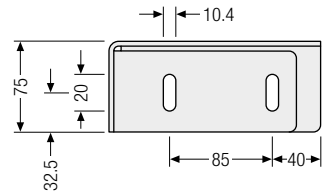
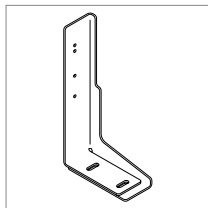
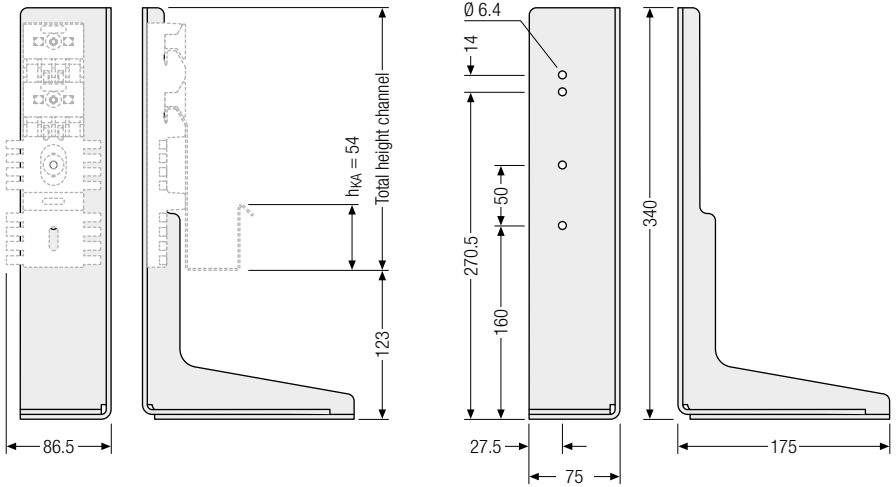
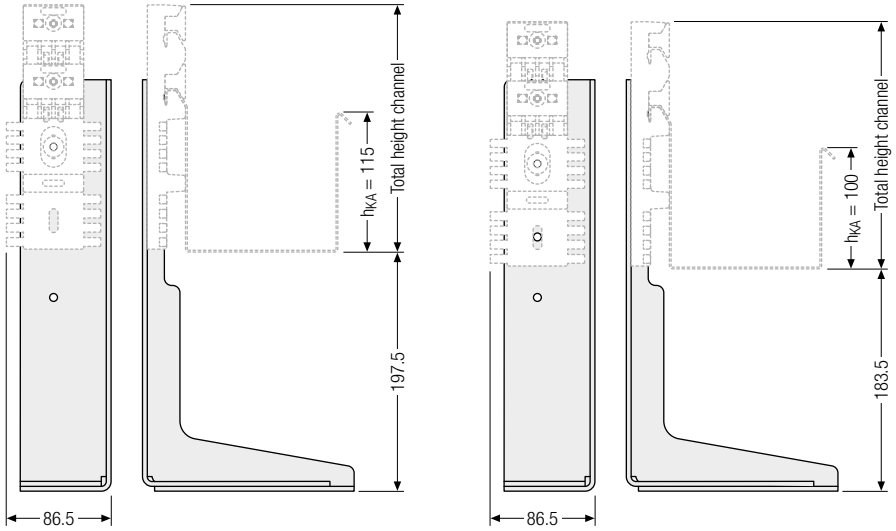

Dimensions | Ceiling holder (Variant A)

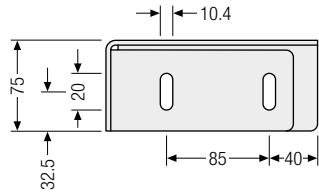
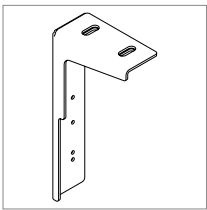
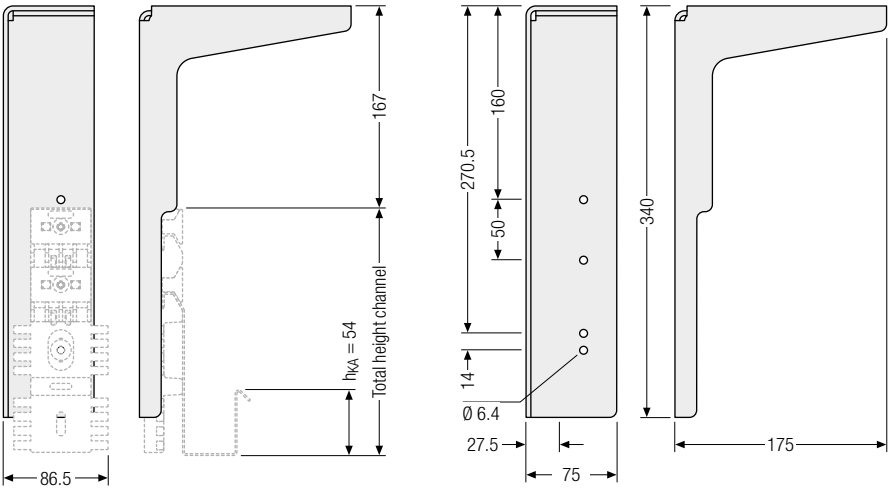
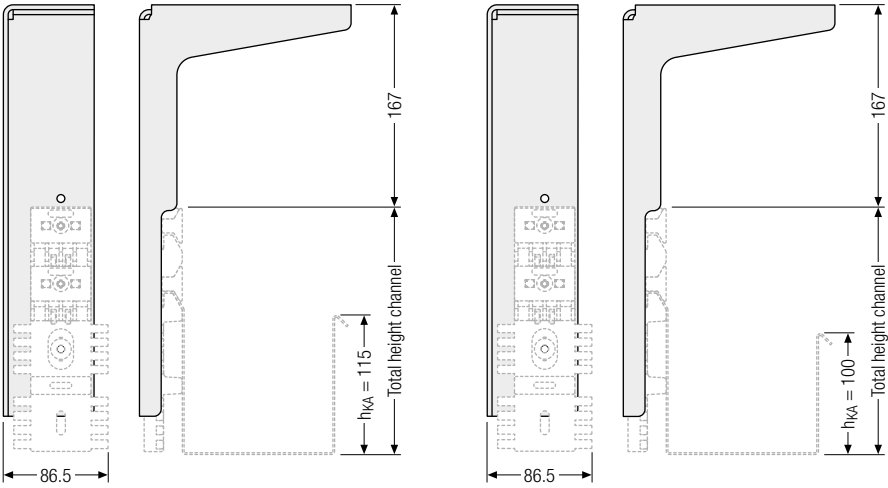

Subject to change without notice.

TRAXLINE®	Accessories	S/SX series	LS/LSX series	CLEANVEYOR®	FLATVEYOR®	ROBOTRAX® System	XLT series	MT series
-----------	-------------	-------------	---------------	-------------	------------	------------------	------------	-----------

QuickTrax® series

B _i [mm]	KR [mm]	h ₁ [mm]	h _{KA} [mm]	Total height channel [mm]	b ₁ [mm]	B _{KA} [mm]	A [mm]	B [mm]	C [mm]	C ₁ [mm]	E [mm]	F [mm]	G [mm]	I [mm]	Y [mm]
QT0320 with channel holder 202 page 138															
25	100	25.5	236.5	269.5	42	90.7	10	79	140	14	129	40	152	54	27
50					67	115.7	35								52
QT0320 with channel holder 155 page 138															
25	100	25.5	236.5	269.5	42	90.7	10	79	140	14	129	40	152	54	27
50					67	115.7	35								52

EasyTrax® series

B _i [mm]	KR [mm]	h ₁ [mm]	h _{KA} [mm]	Total height channel [mm]	b ₁ [mm]	B _{KA} [mm]	A [mm]	B [mm]	C [mm]	C ₁ [mm]	E [mm]	F [mm]	G [mm]	I [mm]	Y [mm]
ET0320 with channel holder 202 page 250															
25	100	25.5	236.5	269.5	42	90.7	10	79	140	14	129	40	152	54	27
50					67	115.7	35								52
ET0320 with channel holder 155 page 250															
25	100	25.5	236.5	269.5	42	90.7	10	79	140	14	129	40	152	54	27
50					67	115.7	35								52

MT series

XLT series

ROBOTRAX® System

FLATVEYOR®

CLEANVEYOR®

LS/LSX series

S/SX series

S/SX-Tubes series

Accessories

TRAXLINE®

 The cable carrier outer width without attachments B_k is taken into account for calculating the inner width of guide channel b₁ and the overall width B_{KA}.

 Information on the fixing options for the Easy Guide Systems can be found on page 863

Dimensions | standing with enclosure (Variant B)

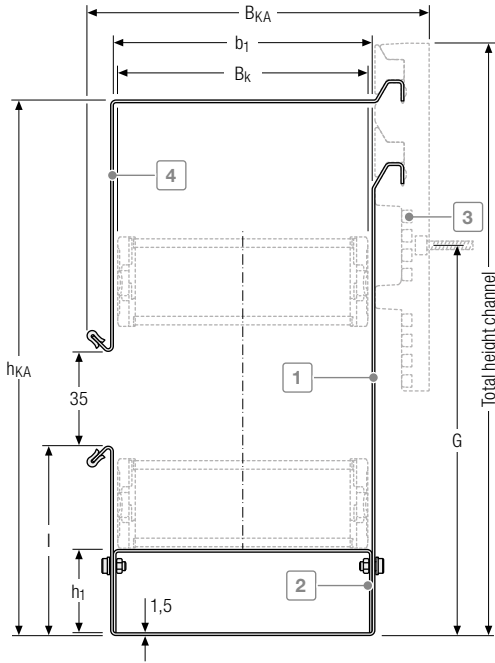

- 1 Guide channel
- 2 Stable gliding support made of zinc plated sheet steel or stainless steel
- 3 Holder
- 4 Enclosure

Slide support height

$$h_1 = h_G$$

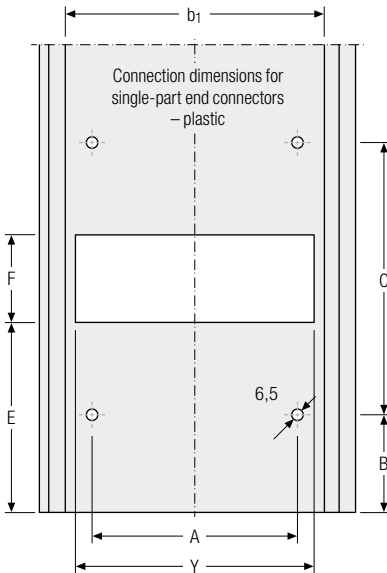

UNIFLEX *Advanced series*

B _i [mm]	KR [mm]	h ₁ [mm]	h _{KA} [mm]	Total height channel [mm]	b ₁ [mm]	B _{KA} [mm]	A [mm]	B [mm]	C [mm]	E [mm]	F [mm]	G [mm]	I [mm]	Y [mm]
UA1455 with channel holder 202 page 162														
58					79	127.7	43.5							64
78	125	36	297	330	99	147.7	63.5	73	152	123	52	212.5	100	84
103					124	172.7	88.5							109
UA1455 with channel holder 155 page 162														
58					79	127.7	43.5							64
78	125	36	297	330	99	147.7	63.5	73	152	123	52	212.5	100	84
103					124	172.7	88.5							109
UA1555 with channel holder 202 page 172														
50					73	121.7	30							58
75	125	50	311	344	98	146.7	55	61	176	121	76	226.5	111	83
100					123	171.7	80							108
UA1555 with channel holder 155 page 172														
50					73	121.7	30							58
75	125	50	311	344	98	146.7	55	61	176	121	76	226.5	111	83
100					123	171.7	80							108

 Standard version of the cable carrier in the Easy Guide System without glide shoes.

MT series

XLT series

ROBOTRAX® System

FLATVEYOR®

CLEANVEYOR®

LS/LSX series

S/SX series

S/SX-Tubes series

Accessories

TRAXLINE®

 The cable carrier outer width without attachments B_k is taken into account for calculating the inner width of guide channel b₁ and the overall width B_{KA}.

 Our engineers will be happy to help with your project planning – please contact us.

 Information on the fixing options for the Easy Guide Systems can be found on page 863

Dimensions | Ground holder (Variant B)

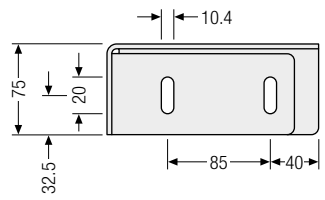
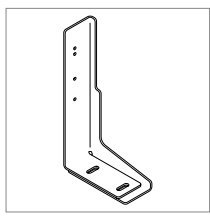
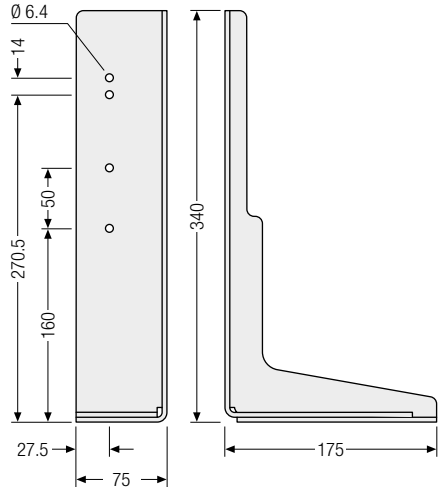
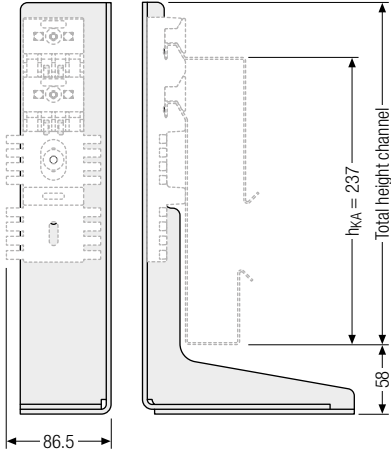
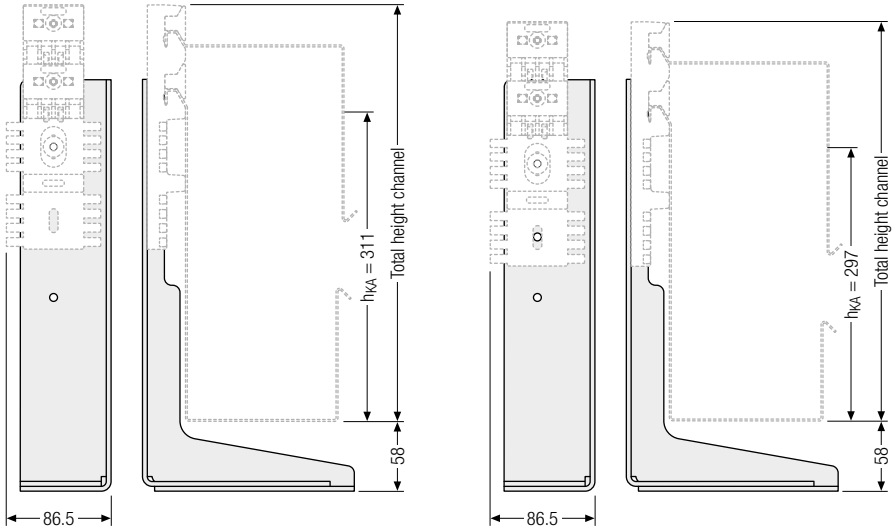

Dimensions | Ceiling holder (Variant B)

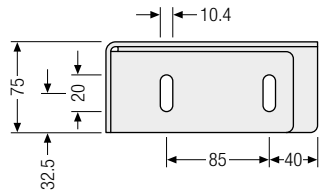
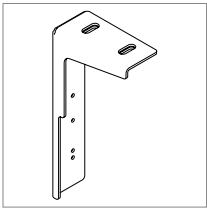
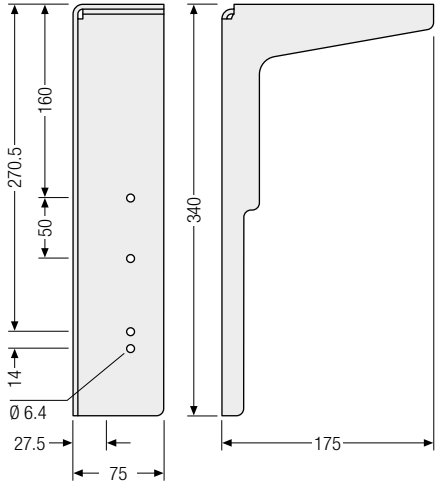
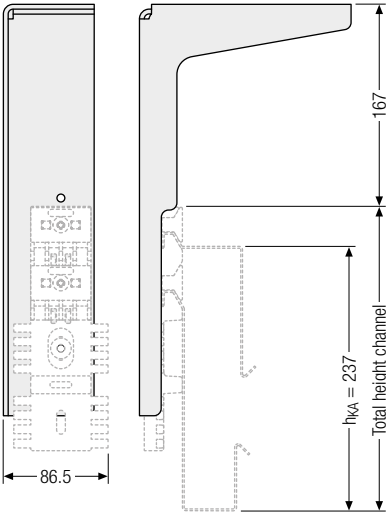
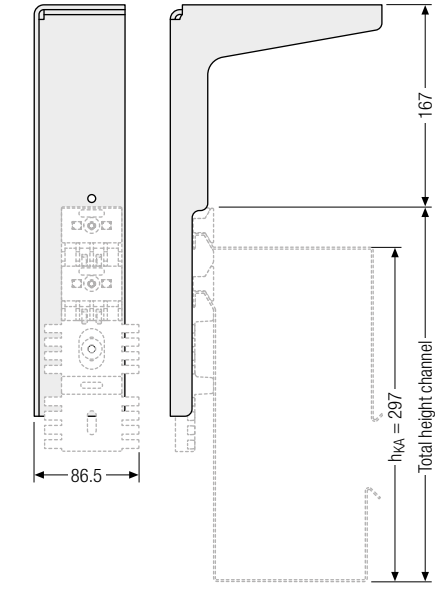
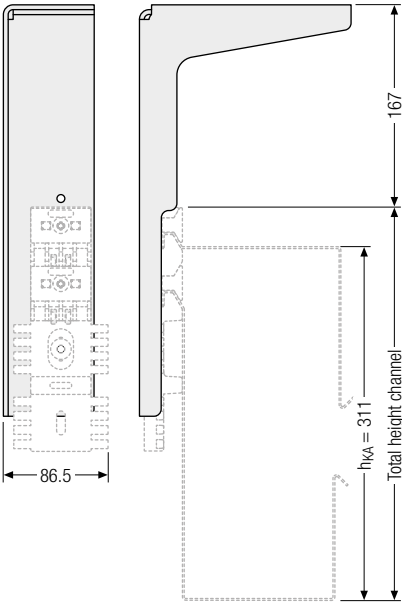

Subject to change without notice.

MT series

XLT series

ROBOTRAX® System

FLATVEYOR®

CLEANVEYOR®

LS/LSX series

S/SX series

S/SX-Tubes series

Accessories

TRAXLINE®

Dimensions | laying on its side (Variant C)

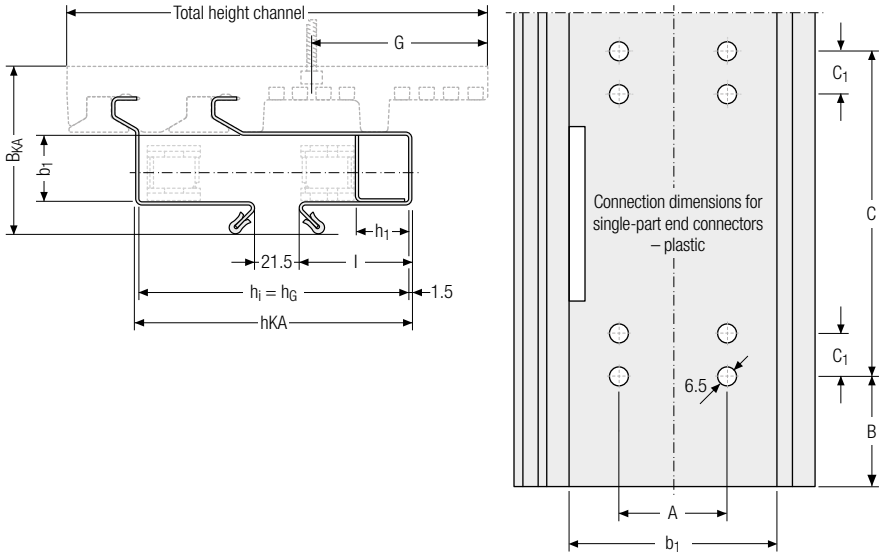

QuickTrax® series | UNIFLEX Advanced series

B_i [mm]	KR [mm]	h_{KA} [mm]	Total height channel [mm]	b_1 [mm]	B_{KA} [mm]	A [mm]	B [mm]	C [mm]	C_1 [mm]	G [mm]	I [mm]
QT0320 UA1320 with channel holder 202 page 138 + 156											
15				32	80.7	—					
25	48	132.5	202	42	90.7	10	85	128	14	37,5	54
50				67	115.7	35.5					
QT0320 UA1320 with channel holder 155 page 138 + 156											
15				32	80.7	—					
25	48	132.5	165.5	42	90.7	10	85	128	14	84,5	54
50				67	115.7	35.5					

Mounting options

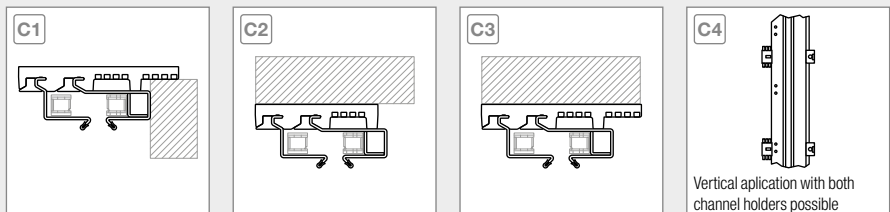

Vertical application with both
channel holders possible



Information on the fixing options for the Easy Guide Systems can be found on page 863

Dimensions | laying on its side (Variant C) | Driver sledge

 For the version of the Easy Guide System laying on its side, the correct carrier sledge has to be used for each cable carrier width.

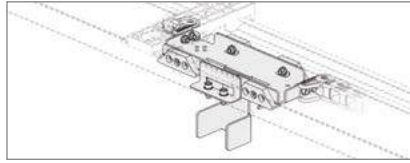

Driver sledge 79-112 for B_i 15

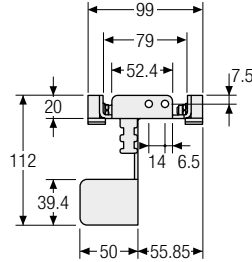
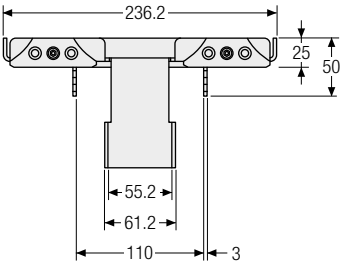

Driver sledge 156-360 for B_i 25

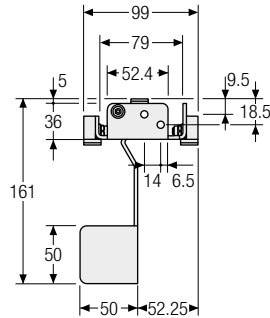
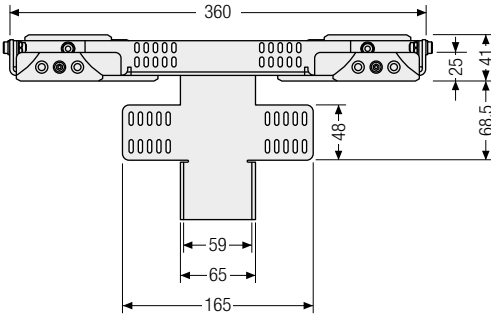

Driver sledge 175-360 for B_i 50

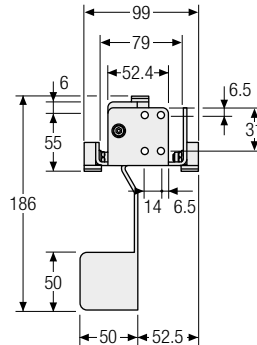
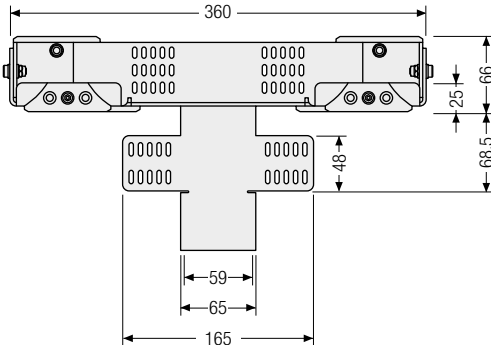

MT series
XLT series
ROBOTRAX® System
FLATVEVOR®
CLEANVEVOR®
LS/LSX series
S/SX series
S/SX-Tubes series
Accessories
TRAXLINE®

Dimensions | Ground holder (Variant C)

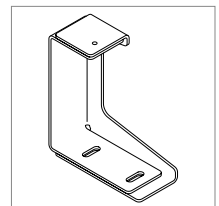
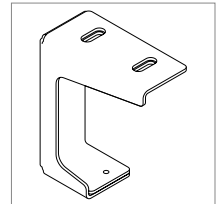
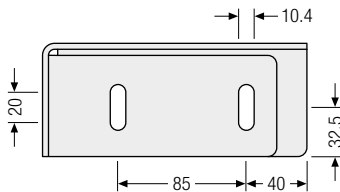
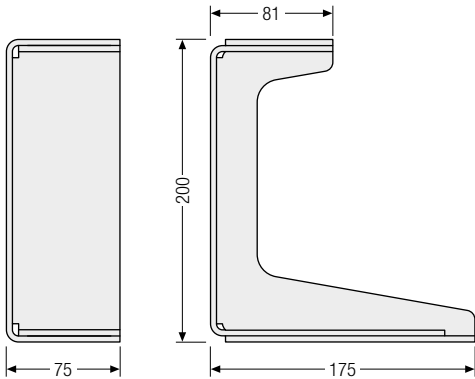
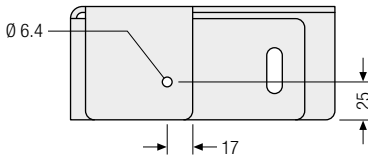
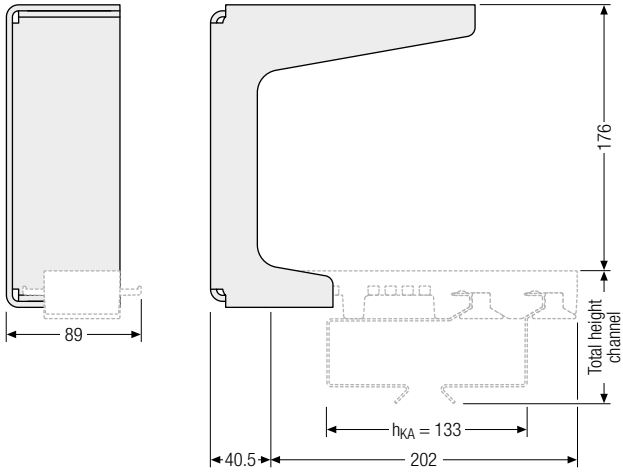

For variant C (laying on its side), the holders have to be mounted on the joins. For variant A and B, the holders can be installed in any position.

Mounting with holder 155

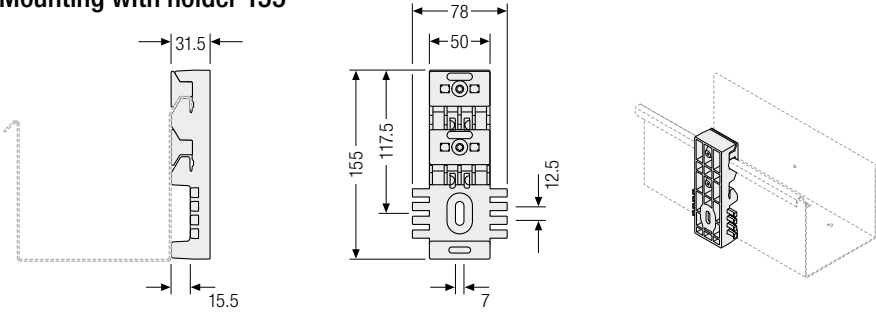

Mounting with holder 202

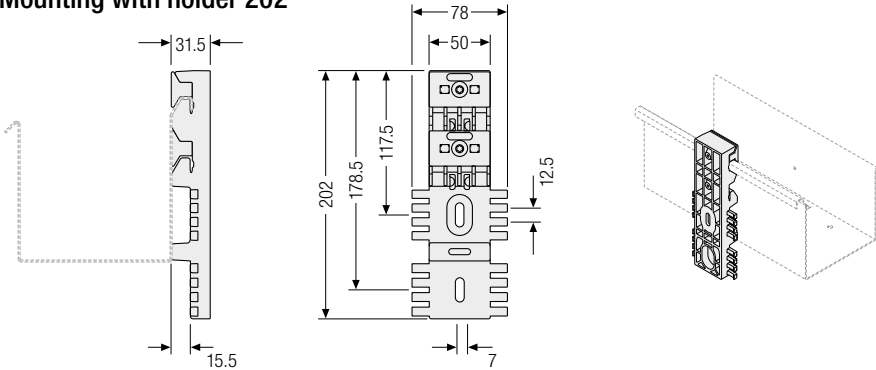

Mounting kit

Set for fixing the holders on the channel.

Installation kit

- | | |
|------------------|-----------------|
| 1 Holder | 5 Screw M4 x 12 |
| 2 Holder clamp | 6 Screw |
| 3 Join connector | 7 Washer |
| 4 Nut | 8 Washer |

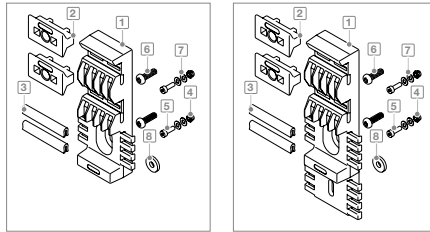

Order example

To order the Easy Guide System, please provide the following information and the used cable carrier:

- Variant of channel (A, B or C)
- Number of guide channels
- Total length of channel
- Support length L_{KA} ¹
- Variant of holder (H155/H202)
- Type of fastening (Wall/ceiling/floor)

MT series
XLT series
ROBOTRAX® System
FLATVEVOR®
CLEANVEVOR®
LS/LSX series
S/SX series
S/SX-Tubes series
Accessories
TRAXLINE®

Guide channels for vertical hanging applications

- Ready-to-install channel system made of aluminum.
- Standardized module.
- Easy installation.
- For elevators, storage and retrieval systems and many other applications.

Aluminum channel system for UNIFLEX *Advanced*

The ready-to-install channel system for vertical hanging applications from TSUBAKI KABELSCHLEPP is ideal for use in fast moving storage and retrieval systems with high lateral accelerations. Other typical fields of application are lifters, elevators, construction elevators, crane elevators or lifts. As a ready-to-connect complete system including driver, cables and strain reliefs, it is very easy to install. Standard parts result in short delivery times and a cost efficient solution. This allows energy and data to be transferred within one system reliably and without interruptions.



Features

- Standardized for UNIFLEX *Advanced* 1555
- Available from 75 mm inner width and 125 mm bending radius
- Other series and types on request
- Suitable for extremely long travel lengths
- Fixed point offset possible
- Fixed point connection alternatively left or right
- Cable outlet on the driver alternatively towards the front or rear
- Standard lengths of the aluminum profile. Custom lengths also possible on request
- Mounting distance of the channel brackets flexibly adaptable
- Optional C-rails for assembly
- Attachment parts in galvanized steel or stainless steel

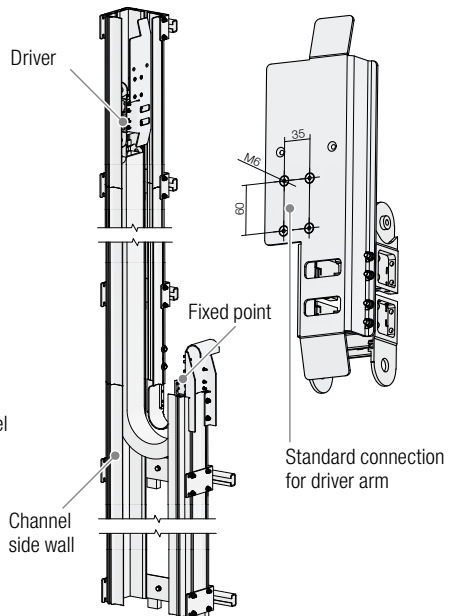

Our engineers will be happy to help with project planning – please contact us

- Assembly profiles with sloping sides can be used for all guide channels for fastening
- Lengths in 50 mm grid possible



C-profile, perforated, 34 x 15 mm

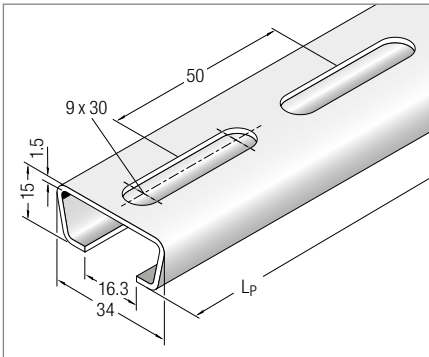

(slot width 16 – 17 mm)

Material

Steel
Stainless steel (ER 1S)

Article no.

3938
3939

Attach profile with cheese-head screws M8 – DIN 6912

C-profile, perforated, 40 x 22 mm

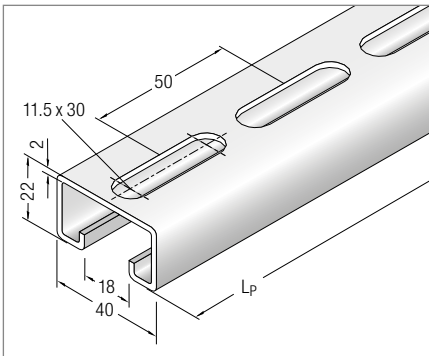

(slot width 18 mm)

Material

Steel
Stainless steel (ER 1S)

Article no.

3940
3941

Attach profile with cheese-head screws M8 – DIN 6912

MT series

XLT series

ROBOTRAX® System

FLATVEYOR®

CLEANVEYOR®

LS/LSX series

S/SX series

S/SX-Tubes series

Accessories

TRAXLINE®

Condition Monitoring

Knowing what's (not) up



Trademarks are legally protected for TSUBAKI KABELSCHLEPP GmbH as a national or international registration in the following countries: tsubaki-kabelschlepp.com/trademarks

Subject to change without notice.

Safety devices for cranes and wear measurement for glide shoes

- » signal is usable for a fully-automatic emergency stop-system
- » direct measurement of the push-/pull-forces at the moving point
- » force limits freely programmable (lower limit, upper limit)
- » error indication if the limits are exceeded
- » outcoming signal PLC usable (full stop, slow down)
- » no speed limit
- » scheduled gliding shoe replacement
- » wear monitoring in real-time
- » wear forecast
- » sensor-free wear elements
- » without additional cables and power supplies inside the cable carrier
- » usable for all glide shoe chains

The installation conditions are difficult? In that case our service team will take care of the mounting or assists and advises you.

Measuring glide shoe wear in the channel



- » Determine and evaluate real-time values
- » Easy to retrofit with exchangeable glide shoes
- » Easy installation by clipping on the glide shoes and installation in the channel
- » No additional cables in the cable carrier
- » Direct connection to your control system without radio transmission
- » Uses standard components



Measuring shear/tensile forces on the standardized driver

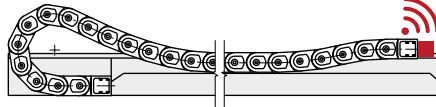

- » Guiding without transverse forces:
 - protects the cable carrier
 - minimizes costs through reduced downtimes
 - reduces defects/malfunctions/damage
- » Integrated shear/tensile force monitoring
- » The compensation of the parallel error between the system and the cable carrier is ensured
- » Defined cable routing through two pre-assembled modules
- » Easy maintenance/disassembly, if necessary
- » Easy retrofitting on an opposite-arrangement system
- » Easy connection options
- » System reliability and availability



Automatic outdoor test facility

TSUBAKI KABELSCHLEPP stands for high quality and reliable solutions. Our outdoor test facility offers realistic test conditions to ensure compliance with the highest standards. Gliding and roller systems with travel lengths over 100 meters as well as high-speed applications are tested by our experts under the toughest conditions.

MT series

XLT series

ROBOTRAX® System

FLATVEVOR®

CLEANVEVOR®

LS/LSX series

S/SX series

S/SX-Tubes series

Accessories

TRAXLINE®

Floating Moving Device

Optimum transfer of cables

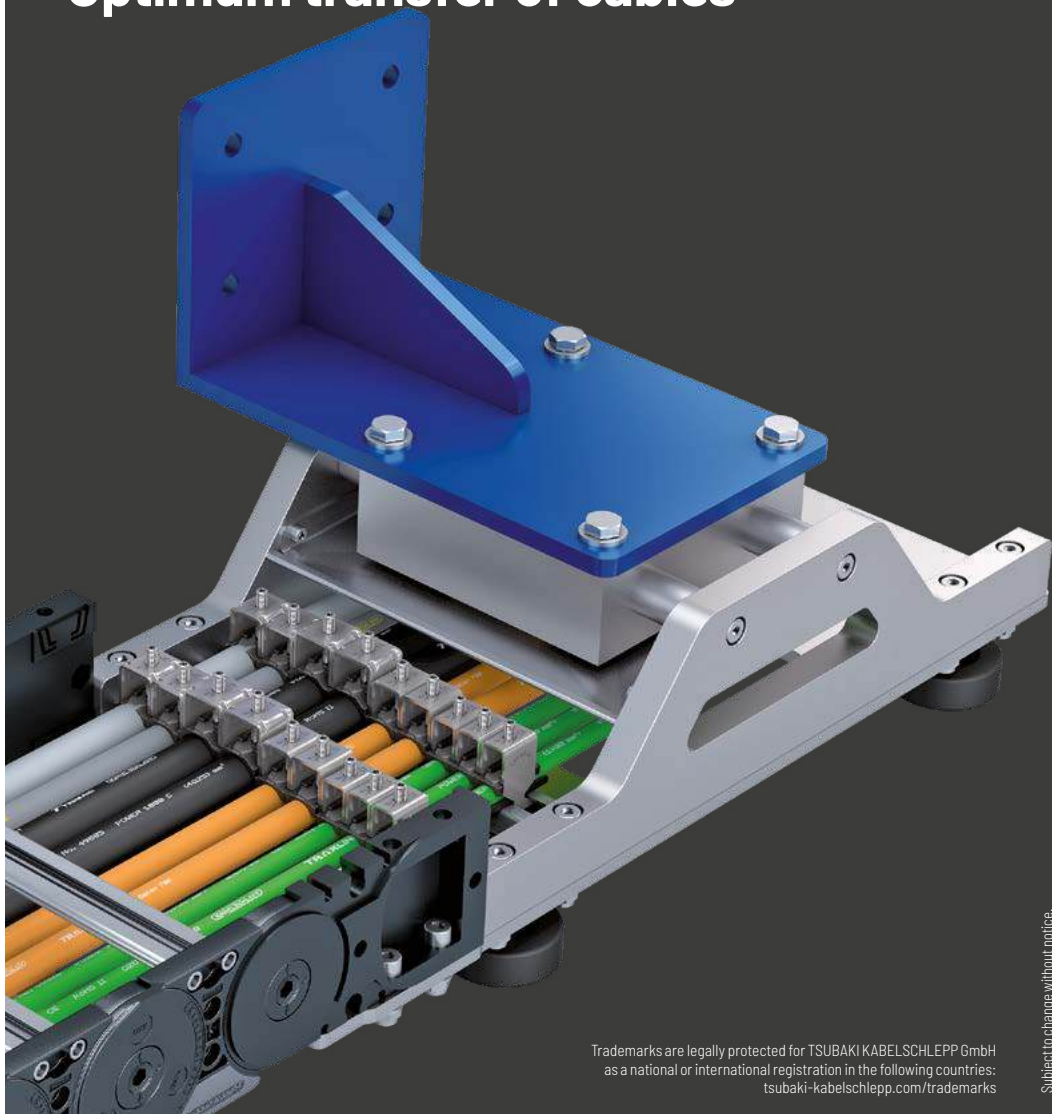

Trademarks are legally protected for TSUBAKI KABELSCHLEPP GmbH
as a national or international registration in the following countries:
tsubaki-kabelschlepp.com/trademarks

Subject to change without notice.

Floating Moving Device (TKFMD) – To compensate for lateral offset in cable carriers

A flexible driver connection is required to ensure guiding of the cable carrier without transverse forces in applications with increased lateral offset.

The connection has to ensure a relative movement between the connection of the cable carrier system and the system driver.

Features

- » **Tolerance compensation:**
 - Horizontal: max. +/- 30 mm,
 - vertical: max. +/- 20 mm
 - Inaccuracies in channel alignment/ manufacturing/assembly are compensated
- » **Continued cable routing**
No threading or passing through of the tail lengths required
- » **Wear**
 - Wear reduced to a minimum
 - Roller-guided system in connection with all Tsubaki Kabelschlepp guide channels
- » **Material**
Stainless steel/aluminum, or painted to customer specifications
- » **Easy installation**
The cable carrier system has two defined mounting assemblies for easy installation of cables and hoses
- » **Cable routing**
The protected continued cable routing in the Floating Moving Device corresponds to the inner height of the cable carrier
- » **Strain relief**
Easy access and assembly with LineFix clamps for strain relief
- » **Standard connection dimensions**
 - For horizontal and vertical connection including GO module (friction-optimized for low wear)

Relevant factors

- » Guiding without transverse forces:
 - protects the cable carrier
 - minimizes costs through reduced downtimes
 - reduces defects/malfunctions/damage
- » The compensation of the parallel error between the system and the cable carrier is ensured
- » Easy maintenance/disassembly, if necessary
- » Easy retrofitting on an opposite-arrangement system
- » Easy connection options
- » System reliability and availability

Suitable for:

Type	Inner width B _i [mm]
M0950	130 - 500
M1250	150 - 800
M1300	140 - 500*

* Additional inner widths on request.

Arrangements

Single-sided arrangement:

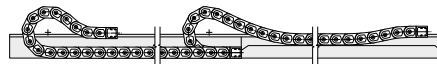

Opposite arrangement:

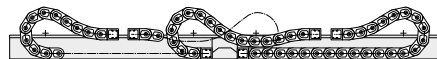

Support rollers

Ball-bearing rollers
for long service life



Trademarks are legally protected for TSUBAKI KABELSCHLEPP GmbH as a national or international registration in the following countries: tsubaki-kabelschlepp.com/trademarks

Subject to change without notice.

Support rollers "Basic"

Support rollers are designed to support the upper run of the cable carrier when the maximum unsupported length is exceeded.

KABELSCHLEPP® support rollers are available for the types LS/LSX 1050, S/SX 0650, S/SX 0950, S/SX 1250 and S/SX 1800.

- » Cost-effective support rollers in lightweight design
- » Long service life thanks to ball bearing rollers
- » Optimized installation width
- » Only to be used for two-band carriers

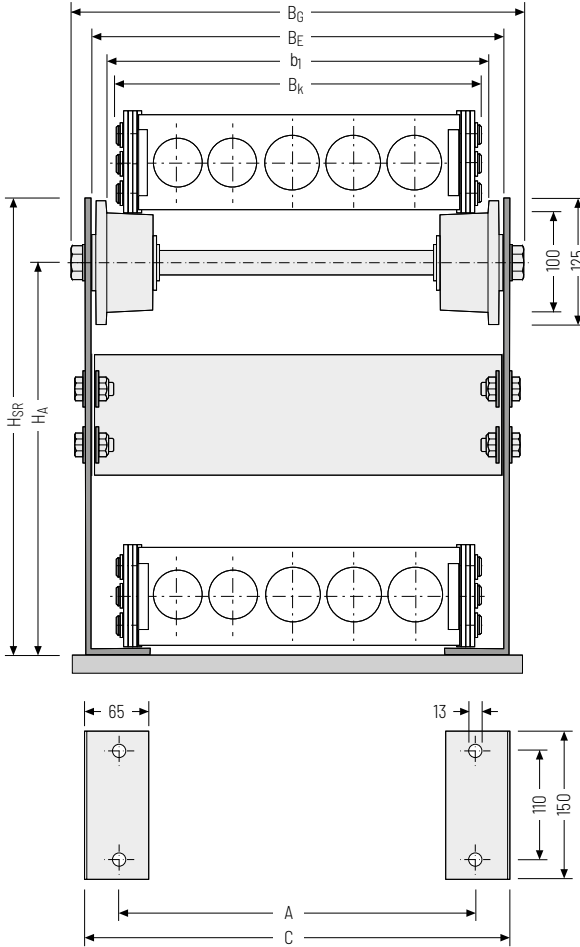

Dimension table for standard support rollers

B_E [mm]	B_G [mm]	b_1 [mm]	H_{SR} [mm]	H_A [mm]	A [mm]	C [mm]
$B_K + 52$	$B_K + 90$	$B_K + 20$	$2 KR + 15$	$2 KR - 50$	$B_K - 10$	$B_K + 60$

MT series

XLT series

ROBOTRAX® System

FLATVEYOR®

CLEANVEYOR®

LS/LSX series

S/SX series

S/SX-Tubes series

Accessories

TRAXLINE®

Reinforced support rollers

Support rollers are designed to support the upper run of the cable carrier when the maximum unsupported length is exceeded.

KABELSCHLEPP® reinforced support rollers are available for the types LS/LSX 1050, S/SX 0650, S/SX 0950, S/SX 1250 and S/SX 1800.

- » Solid design for extreme strain
- » Long service life thanks to ball bearing rollers
- » With hard manganese steel wear protection for type S and applications with high strain
- » Also available in stainless steel
- » Also suitable for multi-band cable carriers

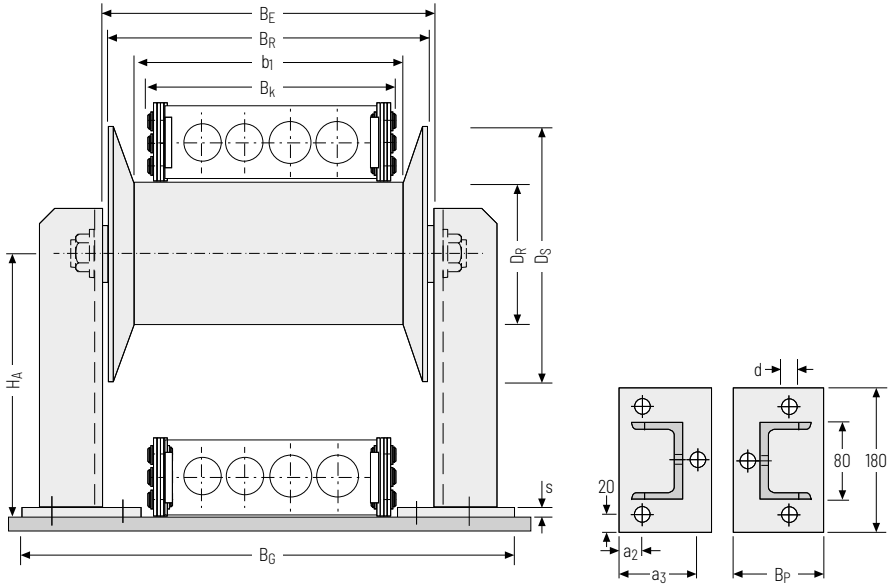

Dimension table for reinforced support rollers

Type	D_R [mm]	b_1 [mm]	B_R [mm]	B_E [mm]	B_G [mm]	D_S [mm]
LS/LSX 1050	120	$B_K + 20$	$B_K + 50$	$B_K + 64$	$B_K + 174$	Ø 200
S/SX 0650	90	$B_K + 15$	$B_K + 45$	$B_K + 59$	$B_K + 169$	Ø 170
S/SX 0950, S/SX 1250, S/SX 1800	120	$B_K + 20$	$B_K + 50$	$B_K + 64$	$B_K + 174$	Ø 200
S/SX 2500	220	$B_K + 30$	$B_K + 60$	$B_K + 74$	$B_K + 184$	Ø 300



Diameter of support roller $D_R = 114$ mm, for standard stainless steel version. The axis height H_A has to be adapted accordingly.

Dimension table for support stands

Type	H_A [mm]	B_P [mm]	a_2 [mm]	a_3 [mm]	d [mm]	s [mm]
LS/LSX 1050	2 KR - 60	100	20	80	Ø 18	8
S/SX 0650	2 KR - 45	80	40	-	Ø 14	8
S/SX 0950, S/SX 1250, S/SX 1800	2 KR - 60	100	20	80	Ø 18	8
S/SX 2500	2 KR - 110	100	20	80	Ø 18	8

MT
seriesXLT
seriesROBOTRAX®
System

FLATVEYOR®

CLEANVEYOR®

LS/LSX
seriesS/SX
seriesS/SX-Tubes
series

Accessories

TRAXLINE®



MT
series

XLT
series

ROBOTRAX®
System

FLATVEYOR®

CLEANVEYOR®

LS/LSX
series

S/SX
series

S/SX-Tubes
series

Accessories

TRAXLINE®

Rolling instead of gliding – the proven principle for reduced friction

Cable carriers on rollers are a secure and reliable solution wherever a gliding system cannot be installed due to very long travel lengths or strong friction. On the RSC, the upper run does not glide on the lower run but on rollers. The rollers are mounted in roller bearings on the side of the cable carriers and permit very long travel lengths, for which substantially less drive power is required. The tensile/push

forces are decreased by up to 90 percent compared to gliding arrangements. Available for the types M0950 and M1300.

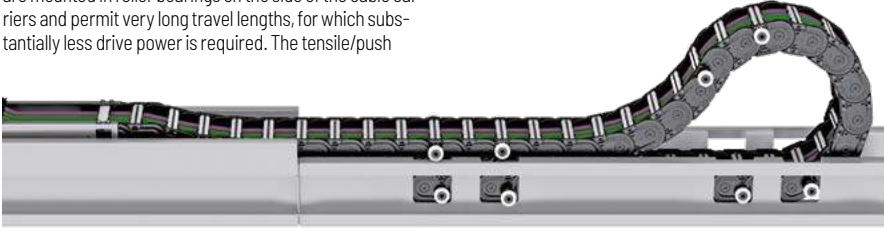

Lower costs and shorter maintenance times

If rollers are worn out, they can easily be replaced during maintenance. This means that time-consuming and expensive replacement of the complete cable carrier is no longer necessary. Notches in the channel allow easy visual checks and the rollers are easy to access. That saves time during maintenance and repair work.

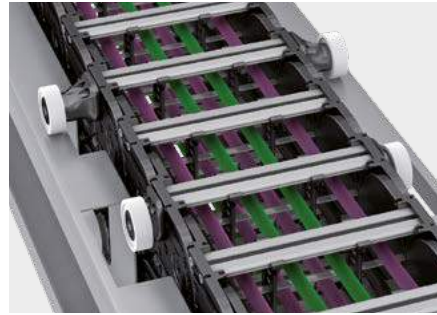

Quiet, low-vibration operation

The rollers run on the guide rail and do not knock against other rollers. Ball bearings and a plastic roller surface support quiet, smooth operation.

Easy maintenance – rollers can be replaced without having to replace the side bands

Cable carrier on rollers (RSC)

- » Suitable for all required travel lengths
- » 90 % lower tensile/push forces than with gliding arrangement and therefore significantly less drive power required
- » Quiet, low-vibration operation
- » Space-saving and cost-optimized through short loop overhang – minimum station length
- » Rollers do not knock against each other
- » Long service life – low maintenance
- » Easy access to the rollers
- » Minimized strain on cable carrier and cable carrier
- » Low push/tensile forces
- » High travel speeds and acceleration
- » High additional loads possible
- » Use of proven standard cable carriers
- » Cable carrier cannot rise up
- » Variable profile lengths, adapted to your connection points

Automatic outdoor test facility

TSUBAKI KABELSCHLEPP stands for high quality and reliable solutions. Our outdoor test facility offers realistic test conditions to ensure compliance with the highest standards. Gliding and roller systems with travel lengths over 100 meters as well as high-speed applications are tested by our experts under the toughest conditions.



Strain relief devices

For optimum placement
with dynamic use of cables



Trademarks are legally protected for TSUBAKI KABELSCHLEPP GmbH
as a national or international registration in the following countries:
tsubaki-kabelschlepp.com/trademarks

Strain relief devices

KABELSCHLEPP® strain reliefs were developed especially for use in cable carriers. We offer the best solution for each of many different areas of application. The type of strain

relief to be selected depends on cable type, length of the cable carrier and installation position.



LineFix® clamps page 878

- » Optimized foot geometry for secure seating in the C-profile.
- » For one cable and two or three cables stacked.
- » For C-profiles with 11 mm slot width.



Strain relief combs page 882

- » Higher fixing force than single-sided strain relief comb.
- » Uniform force transmission in push and pull direction.



SZL strain reliefs page 884

- » Gentle on the cables through large contact area with the cables.
- » Simple mounting without tools.



Block clamps page 885

- » For strain relief of hoses.

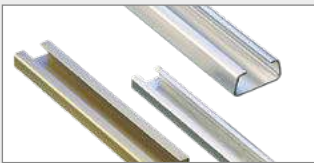

Assembly profiles page 886

- » Assembly profiles for strain relief elements

- » For C-profiles with 11 mm slot width.
- » For one, two or three cables stacked.
- » Optimized foot geometry for secure seating in the C-profile.
- » High grade corrosion protection of the coated housing body through cathodic dip coating (CDC).
- » Pan design with support ribs for secure fixing of the cables.
- » Rounded design of the pan elements, gentle on the cables.
- » Also available in **stainless steel (ER 1S)**.

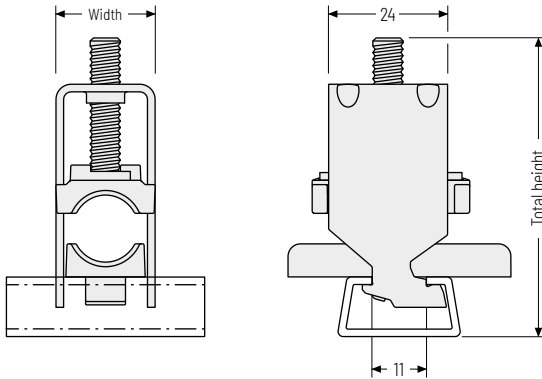

 The data for the total height are guide values.

The actual height depends on the cable diameter and the cable structure, among other things.

Pan design with optimized geometry.

The curved support ribs fix the cables very gently and reliably.



Secure seating and easy assembly

In practical operation, tensile forces occur in both cable directions. Clamps therefore have to transmit high tensile forces in the respective direction.

In contrast to standard commercial clamps, the LineFix® foot geometry ensures transmission of extremely high tensile forces equally in both directions. The catch fixes the foot securely in the C-profile when it is bolted on, preventing the crossbar from tipping out during load application, regardless of the direction of forces or installation.

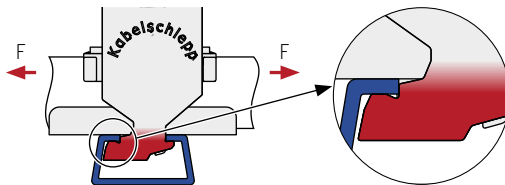

Easy installation even in tight packaging spaces through headless screw with hexagon socket.

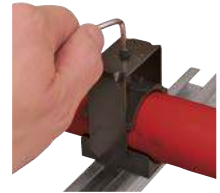

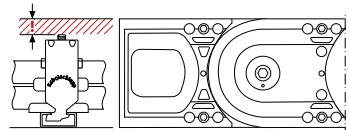

Observe minimum height

For cable carriers with upper run gliding on the lower run, the system height of the strain relief must not be higher than the chain link height!



Dimensions

Type	Designation	Material no. for one complete LineFix®	Material no. for one complete stainless steel LineFix® (ER IS)	min. cable diam. [mm]	max. cable diam. [mm]	No. of cables	Width [mm]	Total height with max. cable diam. incl. C-profile* [mm]
Single clamp								
	LF 12-1	13630	13731	6	12	1	16	55
	LF 14-1	13631	13732	12	14	1	18	52
	LF 16-1	13632	13733	14	16	1	20	54
	LF 18-1	13633	13734	16	18	1	22	56
	LF 20-1	13634	13735	18	20	1	24	59
	LF 22-1	13635	13736	20	22	1	26	61
	LF 26-1	13636	13737	22	26	1	30	70
	LF 30-1	13637	13738	26	30	1	34	74
	LF 34-1	13638	13739	30	34	1	38	78
	LF 38-1	13639	13740	34	38	1	42	82
LF 42-1	13640	13741	38	42	1	46	91	
Double clamp								
	LF 12-2	13641	13742	6	12	2	16	73
	LF 14-2	13642	13743	12	14	2	18	74
	LF 16-2	13643	13744	14	16	2	20	82
	LF 18-2	13644	13745	16	18	2	22	86
	LF 20-2	13645	13746	18	20	2	24	91
	LF 22-2	13646	13747	20	22	2	26	95
	LF 26-2	13647	13748	22	26	2	30	108
	LF 30-2	13648	13749	26	30	2	34	121
	LF 34-2	13649	13750	30	34	2	38	129
	Triple clamp							
	LF 12-3	13650	13751	6	12	3	16	98
	LF 14-3	13651	13752	12	14	3	18	98
	LF 16-3	13652	13753	14	16	3	20	105
	LF 18-3	13653	13754	16	18	3	22	111
	LF 20-3	13654	13755	18	20	3	24	118
	LF 22-3	13655	13756	20	22	3	26	130

* Item no. 3934

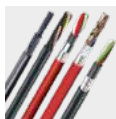

Additional sizes on request.

 Recommended tightening torque:
max. 3 Nm for electric cables suitable for cable carriers

TRAXLINE® cables for cable carriers

Hi-flex electric cables which were especially developed, optimized and tested for use in cable carriers can be found at tsubaki-kabelschlepp.com/traxline

Maximum flexibility with combinable double jaws

The standard sets of LineFix® clamps in size LF/LFX 12 offer even more flexibility and mounting options due to the extension with the new double and counter jaws. Optimized for different cable diameters and individually combinable

heights, almost all requirements can be implemented without any problems.

Double jaw
LD12 d6s12



Double jaw
LD12 d6d6



Counter jaw
LG12 d6



Combination possibilities | Dimensions

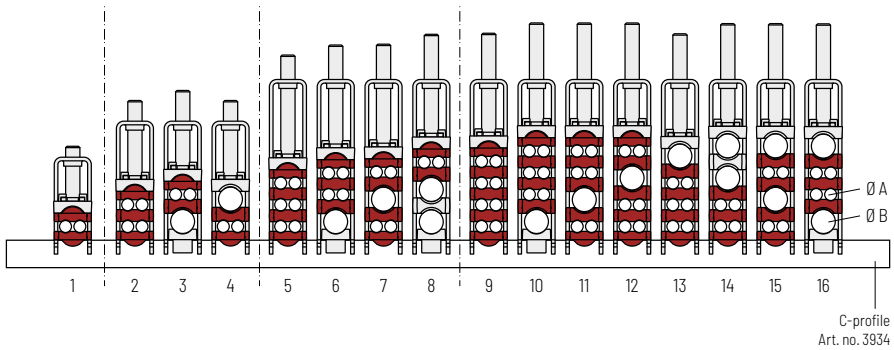

	Material no. for one complete LineFix®	Material no. for one complete stainless steel LineFix® (ER IS)	Cable diam. A [mm]	cable diam. B [mm]	No. of cables	Width [mm]	Total height with max. cable diam. incl. C-profile* [mm]
1	13757	13773	3-6 (2x)	-	2	16	51
2	13758	13774	3-6 (4x)	-	4	16	70
3	13759	13775	3-6 (2x)	6-12 (1x)	3	16	74
4	13760	13776	3-6 (2x)	6-12 (1x)	3	16	70
5	13761	13777	3-6 (6x)	-	6	16	89
6	13762	13778	3-6 (4x)	6-12 (1x)	5	16	94
7	13763	13779	3-6 (4x)	6-12 (1x)	5	16	94
8	13764	13780	3-6 (2x)	6-12 (2x)	4	16	98
9	13765	13781	3-6 (8x)	-	8	16	98
10	13766	13782	3-6 (6x)	6-12 (1x)	7	16	103
11	13767	13783	3-6 (6x)	6-12 (1x)	7	16	103
12	13768	13784	3-6 (6x)	6-12 (1x)	7	16	103
13	13769	13785	3-6 (6x)	6-12 (1x)	7	16	98
14	13770	13786	3-6 (4x)	6-12 (2x)	6	16	103
15	13771	13787	3-6 (4x)	6-12 (2x)	6	16	103
16	13772	13788	3-6 (4x)	6-12 (2x)	6	16	102

* Art. no. 3934

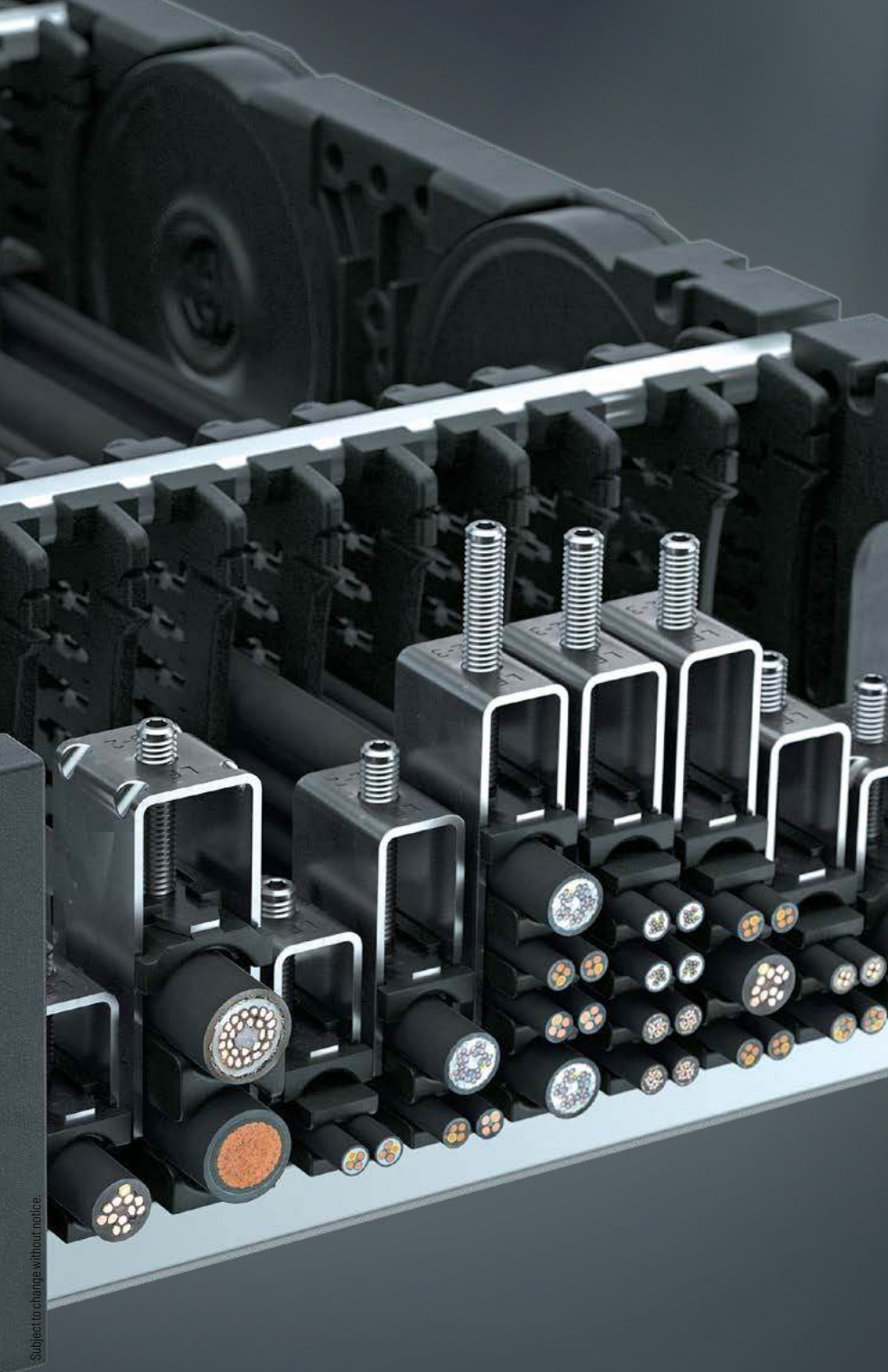

Subject to change without notice.

MT series

XLT series

ROBOTRAX® System

FLATVEYOR®

CLEANVEYOR®

LS/LSX series

S/SX series

S/SX-Tubes series

Accessories

TRAXLINE®

For separate strain relief or fastening of cables outside of the cable carrier – suitable for all cable carriers.

The strain relief combs are equipped with teeth on both sides. This allows secure fixing of each cable with two cable ties.

- » Secure fixing with two or four cable ties
- » Higher fixing force than single-sided strain relief combs
- » Uniform force transmission in push and pull direction
- » Minimized movement of cables and hoses



Strain relief comb with C-profile connections

Mat. no.	b ₁ [mm]	b ₄ [mm]	No. of teeth
53654	49	21	2 x 3
53655	74	46	2 x 5
53656	99	71	2 x 7
53657	124	96	2 x 9
53658	149	121	2 x 11
53659	174	146	2 x 13
76550	54	21	2 x 3
76551	79	46	2 x 5
76552	104	71	2 x 7
76553	129	96	2 x 9
76554	154	121	2 x 11
76555	179	146	2 x 13

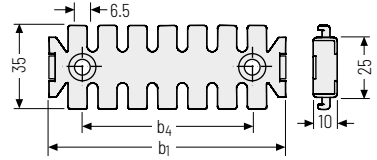

Strain relief comb

Mat. no.	b ₁ [mm]	b ₂ [mm]	b ₄ [mm]	No. of teeth
53983	43,2	53	14	2 x 3
53684	60,0	53	14	2 x 4
57350	61,0	70	20	2 x 4

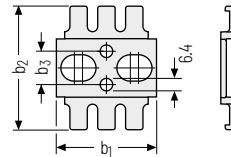

Mat. no.	b ₁ [mm]	b ₂ [mm]	b ₄ [mm]	No. of teeth
53984	63,2	53	15,2	2 x 4
53985	83,2	53	35,2	2 x 6
53986	108,2	53	60,2	2 x 8
53685	85,0	53	25,0	2 x 6
53686	110,0	53	50,0	2 x 8
53687	135,0	53	75,0	2 x 10
53688	160,0	53	100,0	2 x 12
57351	86,0	70	20,0	2 x 6
57352	111,0	70	40,0	2 x 8
57354	136,0	70	65,0	2 x 10
57355	161,0	70	90,0	2 x 12
57356	186,0	70	115,0	2 x 14
57357	211,0	70	140,0	2 x 16
57358	236,0	70	165,0	2 x 18
57359	261,0	70	190,0	2 x 20

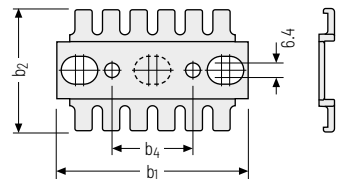

Variable strain relief comb for C-profiles

The variable strain relief combs can be combined with each other as desired in the 1-fold and 5-fold versions and clipped into the C-profiles #3931, #3934, #3935 and 3936 (see page 886).

Mat. no.	b ₁ [mm]	b ₂ [mm]	No. of teeth
3950	12,5	48	2 x 1
3951	62,5	48	2 x 5

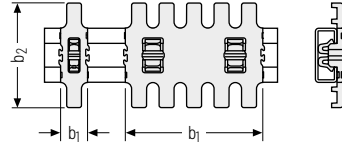

MT series

XLT series

ROBOTRAX® System

FLATVEVOR®

CLEANVEVOR®

LS/LSX series

S/SX series

S/SX-Tubes series

Accessories

TRAXLINE®

- » Cost-effective
- » Assembly - easy, fast and without tools
- » Large-area surrounding of the cables
- » Low height
- » Without screws and cable ties
- » Contact force defined by spring tension bracket
- » Suitable for standard commercial profile rails
- » Protected against vibrations
- » Long service life for dynamic applications
- » Also usable as strain relief in control cabinets

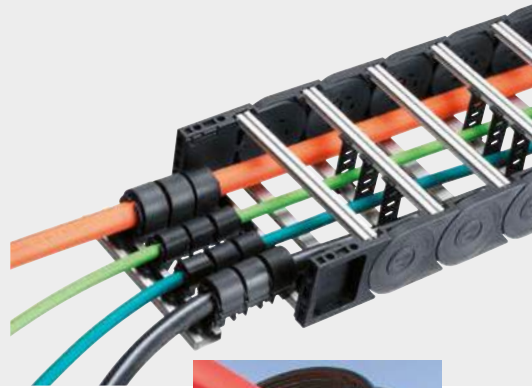

Available sizes

Type	Mat. no.	for cable Ø [mm]	Width Bat		Height H [mm]
			Ø min [mm]	Ø max [mm]	
SZL 8	24989	> 5.0 - 8.0	16	16	28
SZL 10	24990	> 8.0 - 10.5	20	20	30
SZL 14	24991	> 10.5 - 14.5	23	26	35
SZL 18	24992	> 14.5 - 18.0	25	32	40
SZL 22	24993	> 18.0 - 22.0	30	36	44
SZL 27	24994	> 22.0 - 27.0	34	39	50
SZL 32	24995	> 27.0 - 32.0	39	44	56

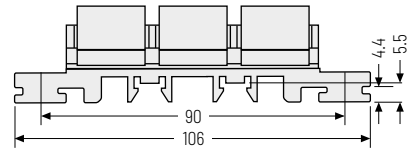
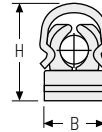

Fixing options



1. Clipped into a C-profile



2. Clipped onto a DIN rail



3. Inserted into two C-profiles



4. Directly bolted on

Installation of the SZL strain relief



MT series

XLT series

ROBOTRAX® System

FLATVEYOR®

CLEANVEYOR®

LS/LSX series

S/SX series

S/SX-Tubes series

Accessories

TRAXLINE®

Block clamps | Overview

- » For strain relief of hoses
- » With clamping screw(s) and support rail nut
- » Hoses and cables
- » For C-rails with slot widths of 11 mm and 16 mm



Available sizes

Type	Mat. no.	for diameter [mm]	Width B [mm]	Height H [mm]
BS 0.06	16701	6-7	28	27
BS 0.07	16702	7-8	28	27
BS 0.08	16703	8-9	28	27
BS 0.09	16704	9-10	28	27
BS 0.10	16705	10-12	28	27
BS 1.06	16706	6-7	37	27
BS 1.07	16707	7-8	37	27
BS 1.08	16708	8-9	37	27
BS 1.09	16709	9-10	37	27
BS 1.10	16710	10-11	37	27
BS 1.12	16711	12-14	37	27
BS 2.14	16712	14-16	42	33
BS 2.16	16713	16-18	42	33
BS 2.18	16714	18-20	42	33
BS 3.20	16715	20-22	50	36
BS 3.22	16716	22-23	50	36
BS 3.23	16717	23-25	50	36
BS 3.25	16718	25-27	50	36
BS 3.27	16719	27-30	59	42
BS 3.30	16721	30-34	59	42
BS 4.32	16722	32-34	59	42
BS 4.34	16723	34-36	71	56
BS 4.35	16724	35-37	71	56
BS 4.38	16725	38-40	71	56
BS 4.40	16726	40-42	71	56
BS 4.42	16727	42-44	71	56
BS 5.45	16728	45-48	86	66
BS 5.48	16729	48-51	86	66
BS 5.51	16731	51-54	86	66

Type BS 0

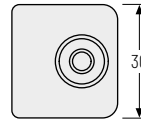
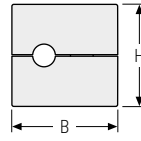
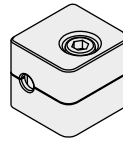

Type BS 1 - BS 5

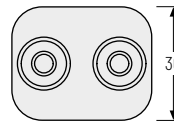
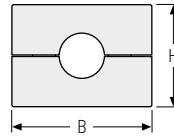
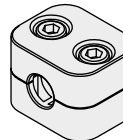

 Suitable for **C profiles** with **11 mm** slot (Article no. 3931, 3934, 3935, 3936) as well as for **C-profiles** with **16 mm** slot (Article no. 3932, 3938, 3939)

- » Assembly profiles for strain relief elements - for all commercially available clamps
- » Length in 1 mm grid available



C-profile 25 x 10 mm

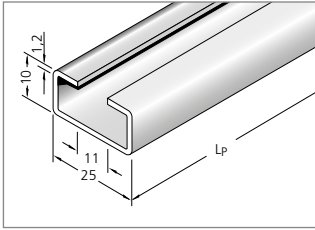

Suitable for all LineFix® clamps
(slot width 11 mm),
 LineFix® types see page 878.

Material	Article no.
Galvanized steel	3931

Attach profile with cheese-head screws M6 - DIN 6912

C-profile 25 x 12 mm

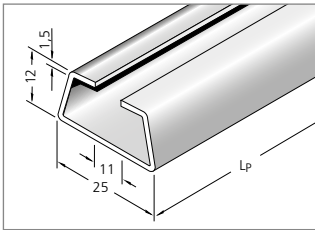

Suitable for all LineFix® clamps
(slot width 11 mm),
 LineFix® types see page 878.

Material	Article no.
Galvanized steel	3934

Attach profile with cheese-head screws M6 - DIN 6912

C-profile 34 x 15 mm

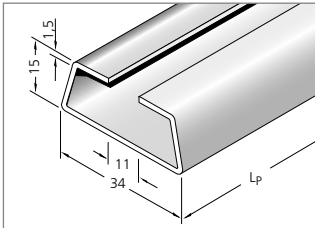

Suitable for all LineFix® clamps
(slot width 11 mm),
 LineFix® types see page 878.

Material	Article no.
Galvanized steel	3935
Stainless steel (ER 1S)	3936

Attach profile with cheese-head screws M6 - DIN 6912

MT series

XLT series

ROBOTRAX® System

FLATVEYOR®

CLEANVEYOR®

LS/SX series

S/SX series

S/SX-Tubes series

Accessories

TRAXLINE®

C-profile 34 x 15 mm

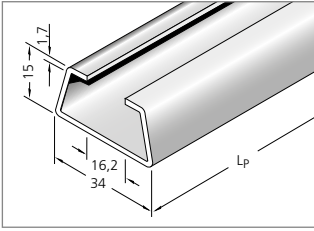

Suitable for all standard clamps
(slot width 16 - 17 mm),

Material

Steel

Article no.

3932

Attach profile with cheese-head screws M10 - DIN 6912



The selection of the suitable C-profile depends on the connecting element.

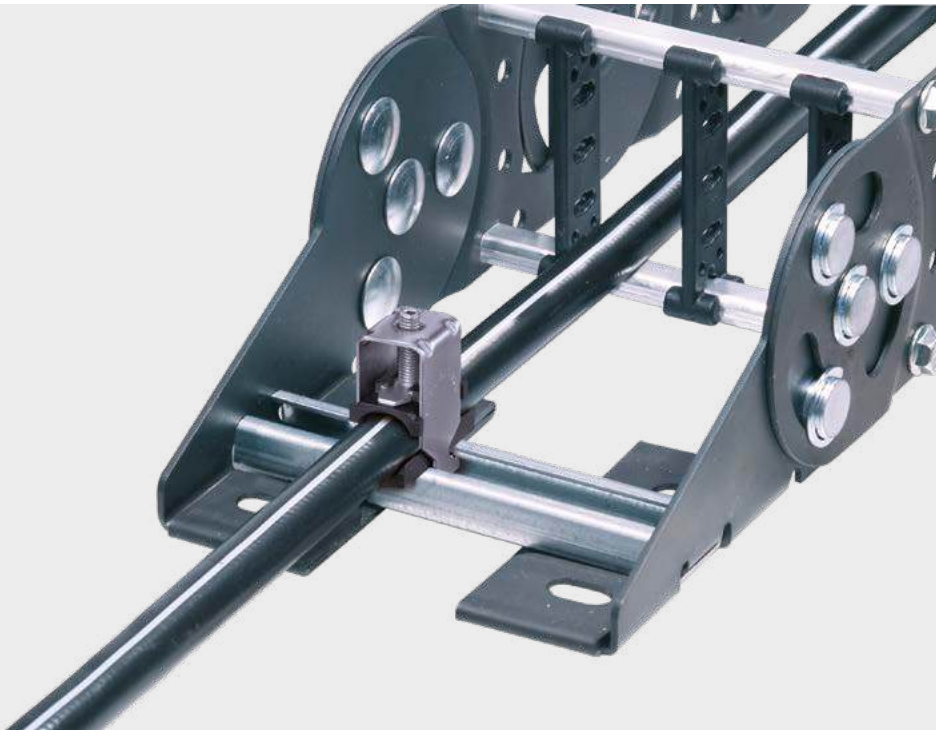

Steel band covers

Continuous, cost-effective protection
against chips and other external
influences



Trademarks are legally protected for TSUBAKI KABELSCHLEPP GmbH
as a national or international registration in the following countries:
tsubaki-kabelschlepp.com/trademarks

Subject to change without notice.

Steel band covers

To protect the cables against flying sparks, radiated heat and small chips, steel band covers made from corrosion-resistant and acid-resistant spring band steel are available.

- » Cost-effective cover variant for **half-stayed** version
- » Maximum steel band width: 1000 mm

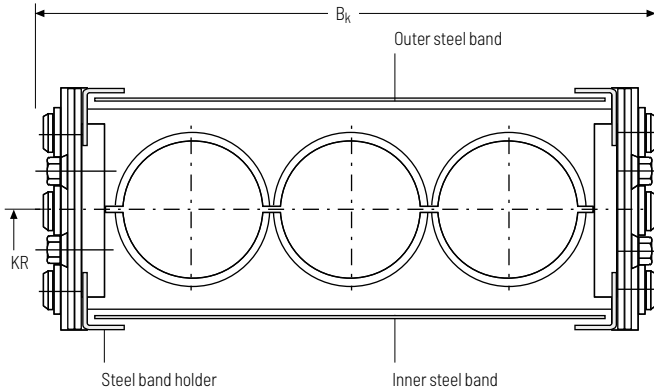

Guiding of the steel band:

with steel band holders on the inside of the side band

Fastening of the steel band:

Inside: with steel band holders on the end connectors

Outside: with the fastening screws of the end connectors

Dimensions table

Type	Steel band length [mm]		Steel band width [mm]
	Outer steel band	Inner steel band	
S/SX 0650	$L_k + 280$	$L_k + 130$	$B_k - 22$
S/SX 0950	$L_k + 360$	$L_k + 150$	$B_k - 27$
S/SX 1250	$L_k + 470$	$L_k + 170$	$B_k - 34$
S/SX 1800	$L_k + 640$	$L_k + 200$	$B_k - 40$
S/SX 2500	$L_k + 945$	$L_k + 255$	$B_k - 46$

Steel band covers for the other types on request!



Steel band holder on the sidebands.



Fastening on the cable carrier connection with special end connector.



Opening tools

Reduce assembly times
and save costs

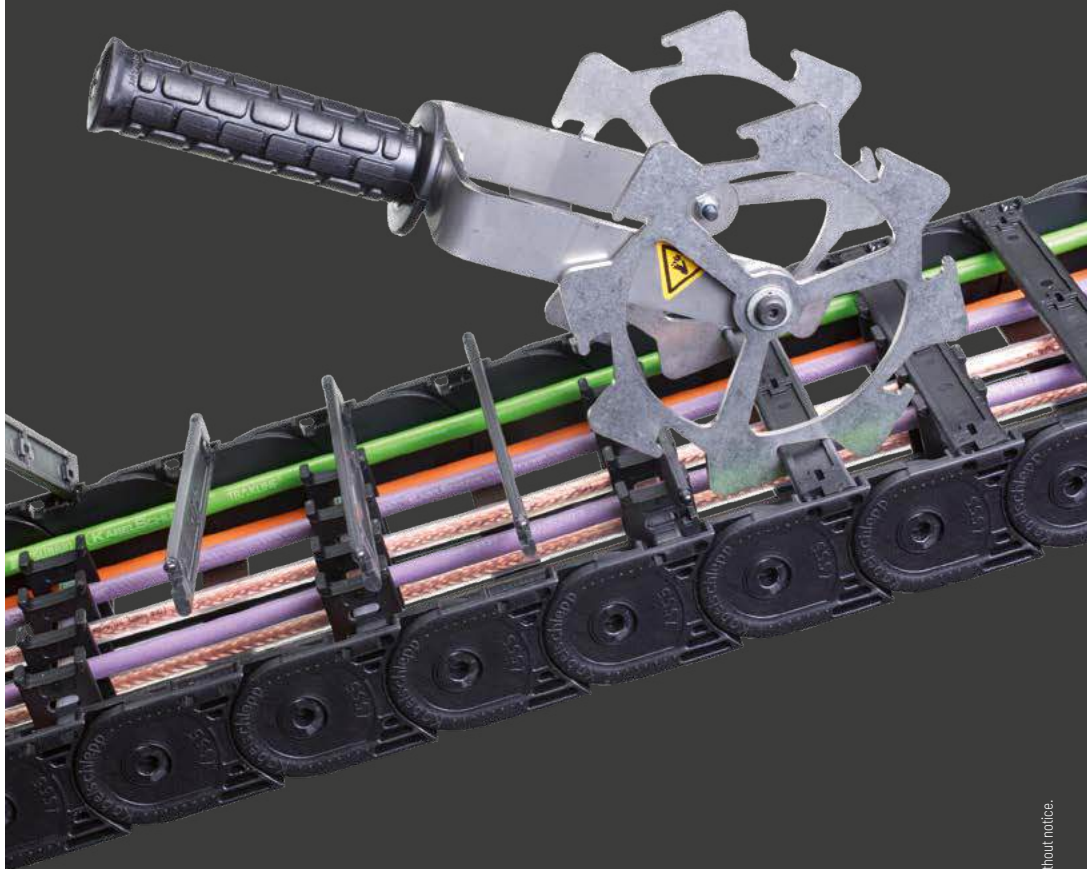

Trademarks are legally protected for TSUBAKI KABELSCHLEPP GmbH
as a national or international registration in the following countries:
tsubaki-kabelschlepp.com/trademarks

Subject to change without notice.

Assembly wrench RV stay

Suitable for all RV stays
Article no. 16094



MT series

Assembly wrench RMF stay

Suitable for all RMF stays
Article no. 16086



XLT series

Assembly wrench RS stay

Suitable for all RS stays
Article no. 16090



ROBOTRAX® System

Screwdriver 7 mm

For opening covers and stays
 (7 mm slot width)
Article no. 16089



FLATVEVOR®

Screwdriver 5 mm

For opening covers and stays
 (5 mm slot width)
Article no. 16085



CLEANVEVOR®

Opening tool Uniflex Advanced

For types 1455, 1555 and 1665

- » Extremely quick and gentle on the material.
- » Open 1 m cable carrier in less than 2 seconds.
- » Can also be used in the guide channel.
- » Even cable carriers equipped with cables can be opened without problems.

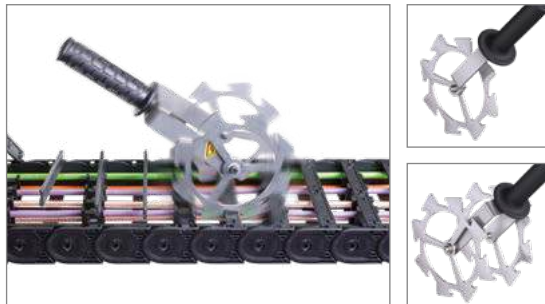

LS/LSX series

S/SX series

S/SX-Tubes series

Type	Version	Article no.
UA 1455	single	16096
UA 1555	single	16098
	twin	16097
UA 1665	single	16100
	twin	16099

Accessories

TRAXLINE®

TRAXLINE®

Cables for Motion

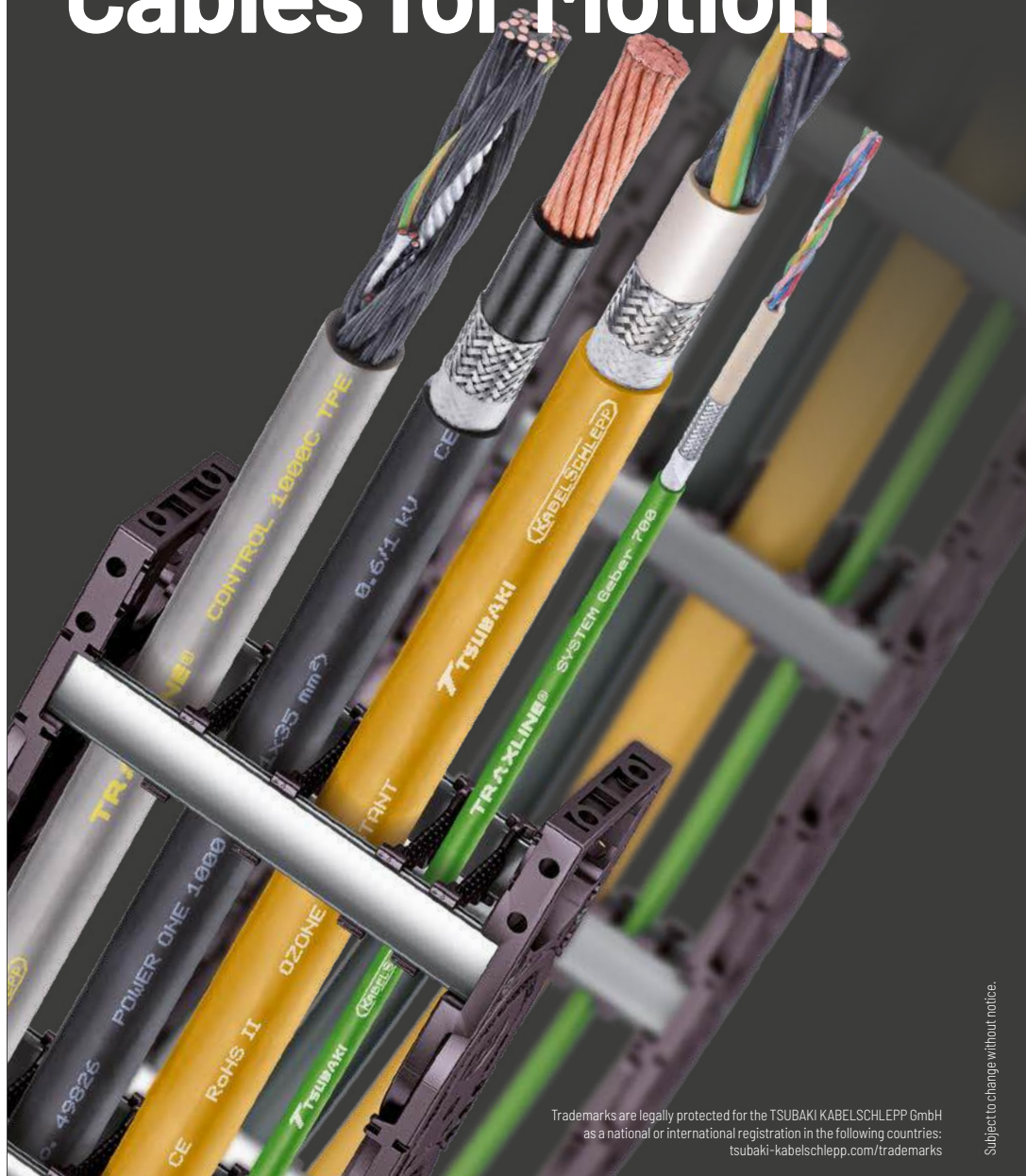

Trademarks are legally protected for the TSUBAKI KABELSCHLEPP GmbH as a national or international registration in the following countries: tsubaki-kabelschlepp.com/trademarks

Subject to change without notice.

TRAXLINE® cables for cable carriers

TSUBAKI KABELSCHLEPP – inventor of the cable carrier. The product portfolio comprises over 100,000 steel, hybrid systems and plastic variants. Always a suitable, reliable cable carrier, whether standard or individual complete solution. We are active for you worldwide. We use our more than 60 years of experience to continuously develop the "driving force" – the TRAXLINE® cables – and adapt them to the requirements of the market.

Our cable series meet the highest quality standards to ensure the availability of your systems.

Our TRAXLINE® cables are continuous bending hi-flex and very durable. Tested functional reliability which meets applicable standards and guidelines is an essential criterion.

Competent, target-oriented system consultation and global on-site service are our constant commitment to the technical and economical optimization of your applications.

Product range

The TRAXLINE® range is continuously being optimized and expanded, especially for the ever increasing requirements of use in cable carriers. A clearly structured type selection provides a unique combination of performance characteristics and usage possibilities.

- » Highest quality requirements
- » Continuous bending hi-flex, very durable
- » Complies with applicable standards and guidelines
- » 2D applications (unsupported and gliding)
- » For all environments from cleanroom applications to tough ambient conditions in a rough operating environment

Service & support

- » Competent, target-oriented system consultation and global on-site service
- » Fast availability through stockkeeping of more than 500 cable types
- » No minimum purchase quantity
- » Special designs for projects

TSUBAKI KABELSCHLEPP cable warehouse

Over 500 cable types, constantly available from the warehouse, ensure fast availability around the globe. We deliver from stock and without minimum purchase quantity.



TRAXLINE® Info center

With the aid of the TRAXLINE® info center, you can find the right cable for your cable carrier system with just a few mouse clicks. Simply enter the parameters for your application at traxline.de and find the ideal cable for your requirements.



MT series

XLT series

ROBOTRAX® System

FLATVEYOR®

CLEANVEYOR®

LS/LSX series

S/SX series

S/SX-Tubes series

Accessories

TRAXLINE®

MT
series**Data cable**

- » Data exchange between moving consumer and stationary end (control cabinet)
- » Different quality classes available
- » Jacket material: PUR, TPE shield respectively double shield optional
- » Used in carriers with small bend radius

XLT
series**BUS-/FOC-/KOAX-cable**

- » Data exchange between moving consumer and stationary end (control cabinet)
- » Different quality classes available
- » Jacket material: PUR, TPE shield respectively double shield optional
- » Used in carriers with small bend radius

ROBOTRAX®
System**Control cable CONTROL 200, 400, 700, 1000**

- » Connection for controlling between moving consumer and control cabinet
- » Four different quality classes available
- » Jacket material: PVC, PUR, TPE; shield optional
- » 2 to 49 wires

FLATVEYOR®

CLEANVEYOR®

**Motor cable POWER 400, 700, 1000, 4 to 7 wires**

- » Connection for power supply between moving consumer and control cabinet
- » In three different quality classes available
- » Jacket material: PVC, PUR, TPE; shield optional
- » Cross section from 1,5 mm² to 150 mm²

LS/LSX
series**Motor cable POWER ONE 700, 1000, 1 wire**

- » For applications in harsh conditions
- » Secure transmission of large amounts of energy
- » For long travel applications
- » Cross section from 0,25 mm² to 700 mm²

S/SX
seriesS/SX-Tubes
series**Medium voltage cable Heavy Duty, 1 wire**

- » For applications in harsh conditions
- » Secure transmission of large amounts of energy
- » For long travel applications
- » Cross section from 0,25 mm² to 700 mm²

Accessories

Individual cable types and the associated data sheets can be found at **TRAXLINE.de**.

Efficient design engineering Precise and fast



Decrease your engineering times, accelerate your design processes, configure with original data directly from the manufacturer.

We are continuously investing in providing product-related data online to make your work easier. This allows you to access current product and CAD data already during the design engineering phase.

We are currently offering comprehensive technical information materials in three online tools which are partially interlinked.



Our web-based Online-Engineer platform with worldwide online access provides a variety of functions to support you with the selection and configuration of products for your application. All necessary technical and calculation information for the individual products from the areas of cable carriers, cables and other accessories are provided on a central, clearly structured platform. Selection of the suitable products is made substantially easier by entering different parameters.

For even more efficient use, the data portals of Online-Engineer and CADENAS are linked. This allows you to quickly and easily download the suitable CAD model for your product configuration without having to exit Online-Engineer.

CADENAS 3D CAD catalog

CADENAS is an internationally used platform for providing 3D component models in a variety of CAD formats. It includes a large number of renowned companies from mechanical engineering, plant engineering and other industry sectors. We are currently offering CAD models in all standard CAD formats for the entire product portfolio. The database also contains the corresponding models for guide channels and support trays. The catalog is continuously expanded and supplemented.



Electrical engineering with ePLAN

The ePLAN Data Portal is an integrated, web-based data platform for providing current device data of market-leading component manufacturers for direct use in project planning with the ePLAN software solution. For the internationally used project planning software ePLAN ELECTRIC P8, we have stored the corresponding data for our TRAXLINE® cables in the ePLAN Data Portal for download.



Subject to change without notice.



More information:
traxline.de



More information:
online-engineer.de



More information:
[tsubaki-kabelschlepp.com/
cadenas](http://tsubaki-kabelschlepp.com/cadenas)



More information:
[tsubaki-kabelschlepp.com/
eplan](http://tsubaki-kabelschlepp.com/eplan)

MT
series

XLT
series

ROBOTRAX®
System

FLATVEVOR®

CLEANVEVOR®

LS/LSX
series

S/SX
series

S/SX-Tubes
series

Accessories

System competence

TOTALTRAX® complete systems

As a specialist for cable carriers and drag chain cables of all kinds, we have been a reliable partner for many decades also when it comes to turnkey complete systems.

Thousands of systems implemented by us are in use worldwide, each individually adapted to the customer application. Whether single harnessed cable carrier or highly complex system – we offer ready-to-install assemblies for almost any area of application.

As a member of the TSUBAKI group, we are part of a globally operating group of companies. This allows us to offer our customers and partners the international presence of a global player combined with the flexibility and creativity of a medium-size enterprise.

The following applies to all systems:

- » Manufactured from high-quality components
- » Perfectly adapted components
- » Optimized turnaround times
- » "Just-in-time" deliveries
- » Complete systems from simple to complex

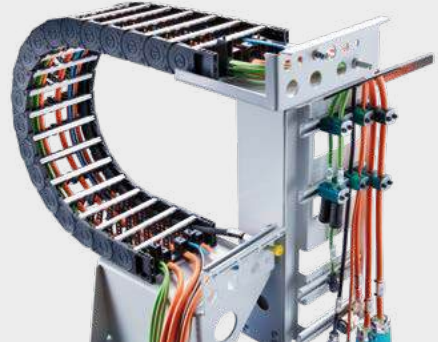

We take care of everything – and you can relax

Our system experts work with you to develop the technical solution as a reliable assembly for your product.

This also includes the correct selection of the individual parts and the procurement of purchase parts: smooth

interaction of all components is essential for a permanently functioning system.

The result: a customized complete system consisting of up to several hundred individual components.

We support you with:

- » Extensive consulting during planning
- » Support for project planning
- » Preparation of an individual cable plan
- » Engineering for precision-fit interfaces
- » Customized system as per customer requirements
- » Procurement of all components
- » Professional support during the entire project
- » Only one contact – continuously from the first project planning meetings until installation

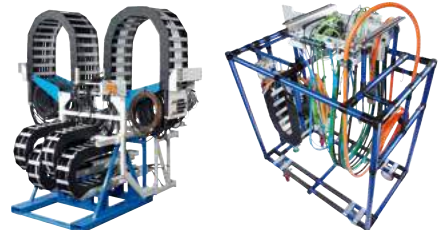
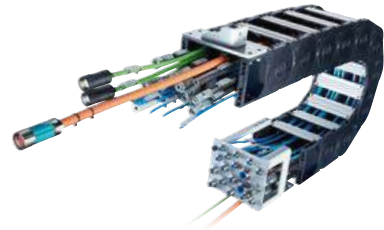

MT series

XLT series

ROBOTRAX® System

FLATVEYOR®

CLEANVEYOR®

LS/LSX series

S/SX series

S/SX-Tubes series

Accessories

TRAXLINE®

Our complete systems – delivered assembled and ready

Optimized manufacturing processes and coordinated provision of the correct components guarantee fast turn-around times and save you time and money, no matter how simple or complex your system is.

For large batches we can set up customer-specific production lines on request. We configure and manufacture economically viable individual solutions from a batch size of just one.

High-quality individual components make our complete systems reliable, resistant and durable. Regular checks

additionally ensure consistently high quality. We even confirm this in writing:

- » for individual components and
- » for ready-mounted assemblies – on request with certificate and comprehensive project documentation

We deliver the cable carrier “just in time” and ready for installation, to your production facility or to the desired installation site. Safely transported in single-use or returnable packaging.

Difficult installation situation?
Our service team can take on the installation or support your with their expertise.



The optimized process:



Standardized manufacturing processes



Use of high-quality components



Customized production line on request



Permanent quality control during production and assembly



Complete installation by our service team

Your benefits at a glance

Obtain your complete system from one source: that makes procurement easier while also saving time and money.

- » Complete delivery from one responsibility
- » One contact for the complete system
- » No storage costs

- » Reduced procurement costs by concentrating on one partner
- » Reduced effort for goods incoming inspections
- » Timely delivery directly to your production facility
- » Shorter downtimes through plug & play installation

MT series

XLT series

ROBOTRAX® System

FLATVEYOR®

CLEANVEYOR®

LS/LSX series

S/SX series

S/SX-Tubes series

Accessories

Around the world.

With our worldwide technical sales and service network we are close to our customers at all times. This ensures quick response, individual support and personal service – based everywhere on an understanding of local requirements..



Headquarters

TSUBAKI KABELSCHLEPP GmbH
Daimlerstraße 2
57482 Wenden-Gerlingen
Fon: +49 2762 4003-0
Fax: +49 2762 4003-220
info@kabelschlepp.de

Business Unit CAPS

KABELSCHLEPP GMBH-Hünsborn
Wielandstraße 1 –
Industriegebiet Ost
D-57482 Wenden-Hünsborn
Fon: +49 2762/9742-0
Fax: +49 2762/9742-699
ksh@kabelschlepp.de

Automotive Division



KABELTRAX, A division of
TSUBAKI KABELSCHLEPP
Daimlerstraße 2
57482 Wenden-Gerlingen
Fon: +49 2762 4003-300
Fax: +49 2762 4003-40300
info@kabeltrax.de · kabeltrax.de

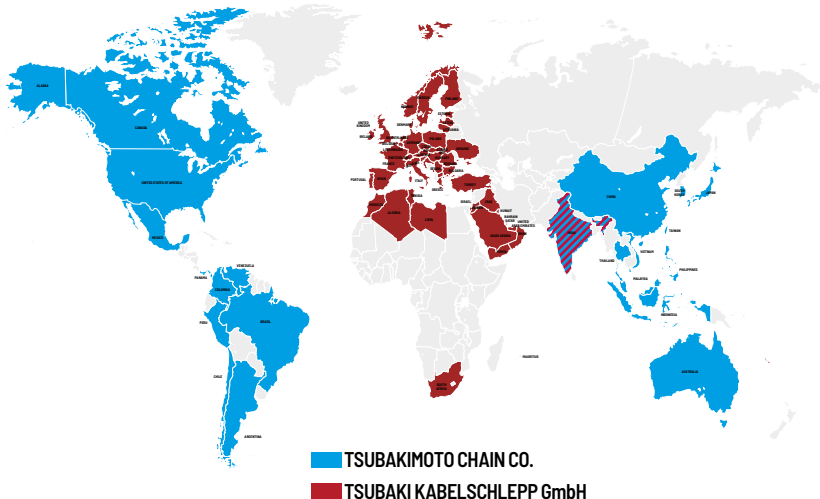

Our worldwide contact persons can be found at: tsubaki-kabelschlepp.com/salesnetwork









Registered trademarks worldwide!



For further information please visit: tsubaki-kabelschlepp.com/trademarks



-  Cable carrier
-  PROTUM® series
-  MT series



-  Cable carrier configuration
-  K series
-  XLT series



-  Configuration guidelines
-  UNIFLEX Advanced series
-  ROBOTRAX® System



-  Materials information
-  M series
-  FLATVEYOR®



-  MONO series
-  CLEANVEYOR®

-  QuickTrax® series
-  XL series
-  LS/LSX series

-  UNIFLEX Advanced series
-  QUANTUM® series
-  S/SX series

-  TKP35 series
-  TKR series
-  S/SX-Tubes series

-  TKK series
-  TKA series
-  Accessories

-  EasyTrax® series
-  UAT series
-  TRAXLINE®

General abbreviations













































- a₁** = Hole distance - side edge
- a₂ / a₃** = Hole distance - outer edge
- a_c** = Nominal width inner chamber
- a_{max}** = Max. travel acceleration
- a_r** = Distance lateral tabs inside to center of first divider
- a_x** = Divider center to center distance
- b₁** = Inner width of support tray/guide channel
- b₂** = Hole distance - channel fixation outside
- b₃** = Hole distance - channel fixation inside
- b₄** = Support width of the support tray
- b_A** = Distance between connection boreholes
- B_A** = Outer width of support tray
- B_E** = Contact width of roller
- B_{EF}** = Overall width of cable carrier incl. attachments
- B_G** = Total width of support
- B_i** = Inner width
- B_k** = Outer width of cable carrier without attachments
- B_{KA}** = Outer width of guide channel
- B_P** = Width of base plate
- B_R** = Width of roller
- B_{St}** = Stay width
- c** = Distance between hole stay bores
- d** = Cable diameter
- D** = Bore diameter
- D_R** = Diameter of support roller
- d_R** = Pipe diameter
- D_S** = Diameter of wheel flange
- G** = Bore hole position
- H** = Connection height
- H_A** = Axle height of support roller
- h_A** = Outer height of support tray
- h_G** = Chain link height
- h_{G'}** = Chain link height incl. glide shoe/roll
- h_i** = Inner height
- H_i** = Inner height of frame stay assembly
- h_{KA}** = Outer height of guide channel
- h₁** = Channel profile height - support height
- h₂** = Channel profile height - run-off height
- HS** = Half-stayed
- H_{SR}** = Height of the support roller
- H_z** = Installation height
- l** = Height channel opening
- K** = Chamber
- K_R** = Bending radius
- l₁** = Connection length
- l₂₋₅** = Connection dimensions
- l_A** = Length of end connector
- l_A** = Length of support tray
- l_B** = Length of carrier in bend
- l_D** = Length of permissible sag
- l_{EF}** = Overall length of cable carrier incl. attachments
- l_f** = Unsupported length
- l_k** = Cable carrier length without connection
- l_{KA}** = Channel length
- l_{KA'}** = Support length
- l_L** = Cable length
- l_{LFE}** = Cable overhang fixed end
- l_{LME}** = Cable overhang moving end
- l_P** = Length of profile
- l_S** = Travel length
- l_y** = Fixed point offset
- n_{RKR}** = Number of RKR links
- n_r** = Number of dividers
- n_z** = Number of comb teeth for strain relief
- q_k** = Intrinsic cable carrier weight
- q_z** = Additional load
- RKR** = Reverse bending radius
- s / s₁** = Sheet metal thickness
- S_H** = Thickness of height separation
- S_T** = Thickness of divider
- t** = Pitch
- T** = Slide support width of guide channel
- U_B** = Loop overhang
- VD** = Position of continuous height separations in divider
- VR** = Position of partial height separations in divider
- v_{max}** = Max. travel speed
- VS** = Fully-stayed
- W_f** = Base width of divider
- X** = Connection distance for opposite arrangement
- z** = Pretension

Cable carrier | Key for abbreviations | Pictographs

Definitions

driver view = view into the driver connection

Pictographs

	Inner height		Stay arrangement on every 2 nd chain link		Clean room suitable
	Outer height		Stay arrangement on every chain link		Quiet running/low noise
	Inner width		Cannot be opened		Sold by the meter
	Outer width		Opens outward		Low weight
	Inner width (B) in x mm increments		Opens inward		Roller chain
	Pitch		Opens inward/outward		ESD material
	Bending radius		Swiveling/pressing in outward		Ex-protection-material
	Long travel length		Swiveling/pressing in inward		Heat-resistant
	Travel length unsupported		Covered cable carrier		Cold-resistant
	Travel length gliding		Sliding dividers		Resistant to hot chips
	High additional load		Fixable dividers		Flame-resistant V0 (UL94)
	High travel acceleration		Fixable dividers in x mm grid		Flame-resistant V2 (UL94)
	High travel velocity		Height separation possible		suitable for railroad applications
	Guide channel required		Height separation in 1 mm increments		Order code
	Strain relief		Hole stay available		Important information

CONTACT

TSUBAKI KABELSCHLEPP GmbH

Daimlerstraße 2
D-57482 Wenden-Gerlingen

Fon: +49 2762 4003-0

Fax: +49 2762 4003-220

E-mail: info@kabelschlepp.de
kabelschlepp.de



760328



The complete product range under:
tsubaki-kabelschlepp.com

EN 02/2023