

High performer.

UT 20-S150 – The NEW ultrasonic sensors with soundpipe attachment



Ultrasonic sensors

System description

Method of function

Ultrasonic proximity switches operate on the basis of echo time-of-flight measurement. An ultrasonic pulse emitted by the sensor is reflected when it hits an object. The sensor calculates the distance from the time elapsed between emission of the ultrasonic pulse and receipt of the echo. Depending on the power

amplifier, the measured distance is converted to a current or voltage signal (analogue sensor) proportional to the distance or the switching output is activated, depending on the set switching point.

Applications

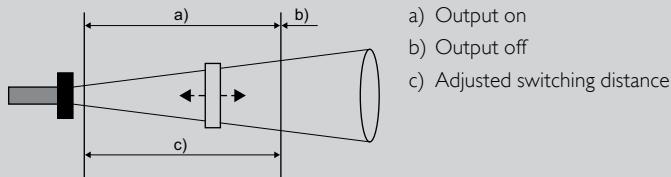

As a reflex scanner (proximity switch)

The classic operating mode uses background suppression, superior to other sensor principles. The switching output is activated when the object is located within the set switching distance. The switching point is subject to a hysteresis. This operating mode is suitable, for example, for detecting objects on a conveyor belt or for checking presence.

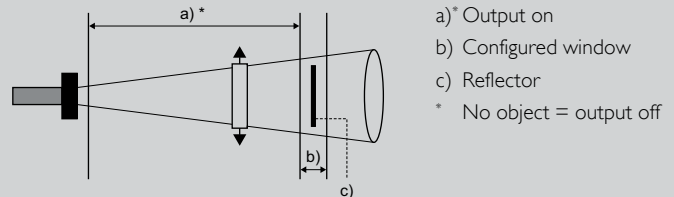

As a barrier or reflex switch

An ultrasonic sensor is used like a light barrier here, though no special reflector is employed (a piece of sheet metal is entirely sufficient here). For this purpose, the sensor in window mode is set in such a way that the reflector is located within the window. The ultrasonic reflex switch provides a signal as soon as an object is completely covered by the reflector. Whereby it is irrelevant whether the object absorbs the sound or even deflects it away. This operating mode is used for poorly detected material with irregular surfaces, e. g. foam.

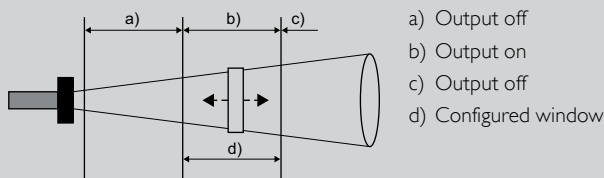

In window mode

The switching output is only activated when the object is located within a window that has been defined by setting two window limits. This can be used to monitor, for example, the correct bottle size in a crate of drinks. Bottles that are too tall or too short are diverted out.

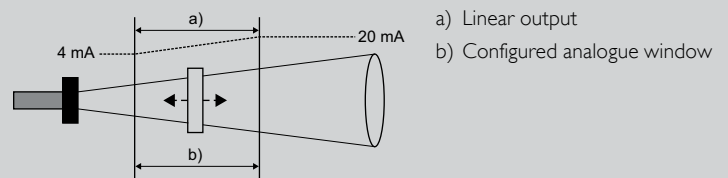

Ultrasonic sensors with analogue output

In these models a voltage (0...10 V) or current (4...20 mA) is transmitted in proportion to the object distance. The window limits can be defined and selected between falling and rising characteristic curves.

Installation

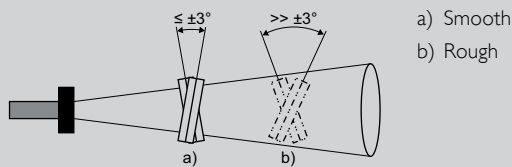

Ultrasonic sensors can be installed and operated in any orientation. Though installation locations that could lead to contamination of the sensor surface should be avoided because water droplets and encrustation can impair functional performance. Thin layers of dust and paint droplets generally have no effect.

If smooth surfaces are to be detected, sensors should be mounted as vertically as possible, i. e. at an angle of from 87° to 93° to the surface.

Rough surfaces, on the other hand, permit considerably greater angular deviations. A surface whose valley-to-peak depth is greater than or equal to the wavelength of the ultrasonic frequency is considered rough. The sound, however, is then reflected diffusely, which can lead to a reduction of the operating scanning distance. In this case the maximum permissible angular deviation and maximum scanning distance should be determined in trials.

Sound-absorbing materials (such as cotton wool or foam) can further reduce the scanning distance. In contrast, liquids and solid materials are good reflectors.

Mounting distances

a) Switching distance

Sensor Range	Vertical Distance (A)	Horizontal Distance (B)
0.25 m	≥ 0.35 m	≥ 2.50 m
0.35 m	≥ 0.40 m	≥ 2.50 m
1.30 m	≥ 1.10 m	≥ 8.00 m
3.40 m	≥ 2.00 m	≥ 18.00 m
6.00 m	≥ 4.00 m	≥ 30.00 m

The table provides the minimum distances between non-synchronised ultrasonic sensors. Sensors may mutually influence one another if these distances are not observed.

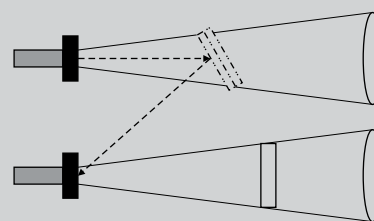

The above-mentioned mounting distances are only intended as a guide. In the case of tilting, the sound can be reflected towards the neighbouring sensor. The minimum distance should then be determined by means of trials. Some sensors permit synchronisation with one another and thus allow considerably lower scanning distances.

UT 20-S150-P/N

Ultrasonic sensor with soundpipe



PRODUCT HIGHLIGHTS

- Ideal for level control, particularly in narrow containers
- Narrow sound beam for precise detection even through small openings and drilled holes
- Reliable detection of highly transparent objects
- Detection independent of object colour and surface
- Compact miniature housing for use when space in machine is limited

Sensor data		Functions	
Limiting scanning distance	250 mm	LED indicator, green	Operating voltage indicator
Operating scanning distance	20 ... 140 mm	LED indicator, yellow	Switching output indicator
Ultrasonic frequency	~ 380 kHz	Scanning distance adjustment	Via Teach-in button
Resolution	0,20 mm	Teach-in modes	Mode 1: Set switching point Mode 2: Set Window Mode Mode 3: Set two-way / reflex switch
Repeatability	± 0.15 % ¹	Adjustment possibilities	N.O. / N.C. via Teach-in button Button lock via Teach-in button Synchronisation via control input Default settings via Teach-in button
Hysteresis	2 mm	Default settings	Max. sensitivity and N.O.
Temperature drift	0.17 % / °C		
Electrical data		Mechanical data	
Operating voltage, +U _b	20 ... 30V DC ²	Dimensions	32 x 38.5 x 12 mm
No-load current, I ₀	≤ 25 mA	Enclosure rating	IP 67 ³
Output current, I _e	200 mA	Material, housing	ABS
Protective circuits	Reverse-polarity protection U _b / Short circuit protection (Q)	Material, ultrasonic converter	Polyurethane foam, epoxy resin with glass content
Protection class	2	Type of connection	(see selection table)
Standby time	< 300 ms	Ambient temperature, operation	-25 ... +70 °C
Switching output, Q	PNP / NPN (see selection table)	Ambient temperature, storage	-40 ... +85 °C
Output function	N.O. / N.C.	Weight	10 g
Switching frequency, f (ti/tp 1:1)	25 Hz	Vibration and impact resistance	EN 60947-5-2
Response time	24 ms		
Connection, WH	Sync.		

¹ From final value of limit scanning distance ² Max. 10 % ripple, within U_b ³ With connected IP 67 plug

Operating scanning distance	Switching output	Type of connection	Order reference	Part number
20 ... 140 mm	PNP	Metal plug, M8x1, 4-pin	UT 20-S150-PSM4	693-11012
20 ... 140 mm	NPN	Metal plug, M8x1, 4-pin	UT 20-S150-NSM4	693-11013

Plug connection

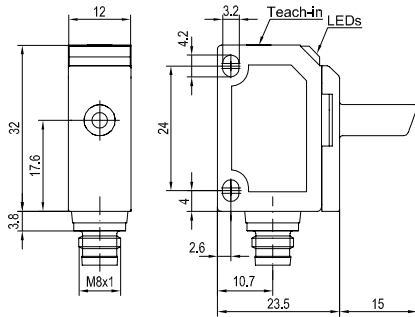

153-00982

4-pin connection

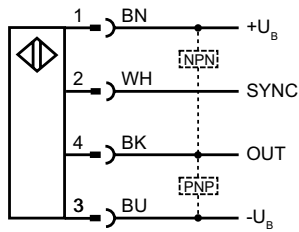

154-00116

Sound beam

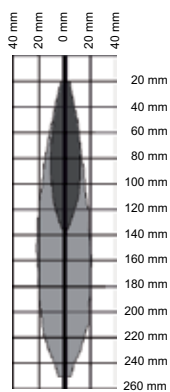

155-01528

Synchronisation / triggering

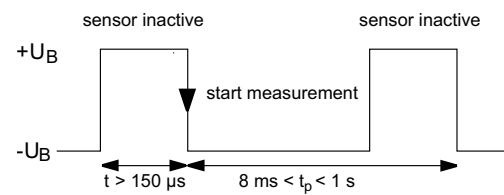

Apply square-wave signal to Sync input.
 Pulse width $t > 150 \mu\text{s}$, Repeat rate $t_p = 8 \text{ ms} \dots 1 \text{ s}$.
 A high level $+U_B$ at Sync input deactivates the sensor.

155-00131

UT 20-S150-A

Ultrasonic sensor with soundpipe and analogue output



PRODUCT HIGHLIGHTS

- Ideal for level control, particularly in narrow containers
- Narrow sound beam for precise detection even through small openings and drilled holes
- Reliable detection of highly transparent objects
- Compact miniature housing for use when space in machine is limited
- Analogue output 0 ... 10V or 4 ... 20 mA

Sensor data ¹		Functions	
Limiting scanning distance	250 mm	LED indicator, green	Operating voltage indicator
Operating scanning distance	20 ... 140 mm	LED indicator, yellow	Switching output indicator
Ultrasonic frequency	~ 380 kHz	Set analogue characteristic	Via Teach-in button
Resolution	0,20 mm	Adjustment possibilities	Rising / falling edge via Teach-in button
Repeatability	± 0.15 % ²		Button lock via Teach-in button
Temperature drift	≤ 2 %		Synchronisation via control input
			Default settings via Teach-in button
Electrical data		Mechanical data	
Operating voltage, +U _B	20 ... 30V DC ³	Dimensions	32 x 38,5 x 12 mm
No-load current, I ₀	≤ 25 mA	Enclosure rating	IP 67 ⁴
Current output	R _a < 500 Ω	Material, housing	ABS
Voltage output	R _a > 500 Ω	Material, ultrasonic converter	Polyurethane foam, epoxy resin with glass content
Protective circuits	Reverse-polarity protection U _B / Short circuit protection (Q)	Type of connection	(see selection table)
Protection class	2	Ambient temperature, operation	-25 ... +70 °C
Standby time	< 300 ms	Ambient temperature, storage	-40 ... +85 °C
Analogue output	0 ... 10V / 4 ... 20 mA (see selection table)	Weight	10 g
Response time	30 ms	Vibration and impact resistance	EN 60947-5-2
Connection, WH	Sync.		

¹ After 30 min. settling time ² From final value of limit scanning distance ³ Max. 10 % ripple, within U_B ⁴ With connected IP 67 plug

Operating scanning distance	Analogue output	Type of connection	Order reference	Part number
20 ... 140 mm	0 ... 10V	Metal plug, M8x1, 4-pin	UT 20-S150-AUM4	693-11014
20 ... 140 mm	4 ... 20 mA	Metal plug, M8x1, 4-pin	UT 20-S150-AIM4	693-11015

Plug connection

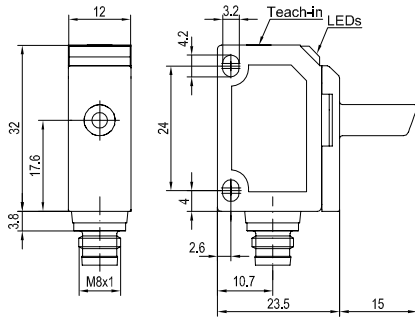

153-00982

4-pin connection

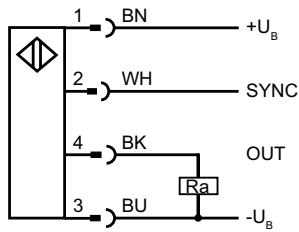

154-00115

Sound beam

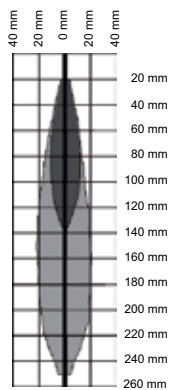

155-01528

Synchronisation / triggering

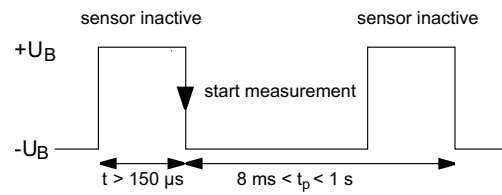

Apply square-wave signal to Sync input.
Pulse width $t > 150 \mu\text{s}$, Repeat rate $t_p = 8 \text{ ms} \dots 1 \text{ s}$.
A high level $+U_B$ at Sync input deactivates the sensor.

155-00131

We look ahead.

Yesterday, today and in the future.

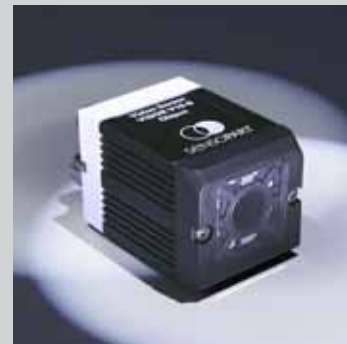
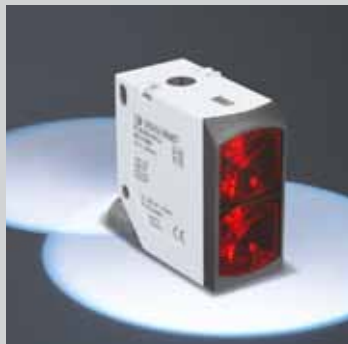

Since SensoPart was founded in 1994, we have constantly focussed on the future. Our motto has always been: We gauge ourselves not by what is possible today, but by our ideas for what can be achieved in the future. Many ground-breaking ideas from that time have since become successful products, which are now indispensable in modern automation technology – endorsed by the numerous prizes for innovation which we have received over recent years. Today, SensoPart is the technological leader in many areas of industrial sensor technology. And we still have many ideas for the future.

SENSOR TECHNOLOGY

- Light barriers
- Proximity switches
- Laser sensors
- Miniature sensors
- Distance sensors
- Colour sensors
- Contrast sensors
- Anti-collision sensors
- Slot sensors
- Fibre-optic amplifiers
- Inductive sensors
- Capacitive sensors
- Ultrasonic sensors

VISION

- Vision sensors
- Smart cameras
- Object detection
- Object measurement
- Colour detection
- Code reading
- Lighting
- Lenses

Find the suitable product
for your application under
www.sensopart.com

Germany
SensoPart
Industriesensorik GmbH
Nägelseestraße 16
D-79288 Gottenheim
Tel. +49 7665 94769-0
Fax +49 7665 94769-765
www.sensopart.com

France
SensoPart France SARL
11, rue Albert Einstein
Espace Mercure
F-77420 Champs – Marne la Vallée
Tél. +33 164 73 00 61
Fax +33 164 73 10 87
www.sensopart.com

Great Britain
SensoPart UK Limited
Unit 12 – 14, Studio 1
Waterside Court, Third Avenue,
Centrum 100, Burton on Trent
DE14 2WQ
Tel. +44 1283 567470
Fax +44 1283 740549
www.sensopart.com

USA
SensoPart Inc.
28400 Cedar Park Blvd
Perrysburg OH 43551,
USA
Tel. +1 866 282-7610
Fax +1 419 931-7697
www.sensopart.com