

52104330	DATA SHEET	
Valid from: 12.06.2023	SKINDICHT® ZS-M / ZS-M-XL	

The SKINDICHT® ZS-M / ZS-M-XL are hexagonal adapters with metric connecting thread and internal PG-thread. The adapters enable the use of glands with PG threads in metric housing openings.



Technical features:

Material	Brass, nickel-plated
External thread	M12x1.5 up to M63x1.5 acc. to EN 60423
Internal thread	PG7 up to PG48 acc. to DIN 40430
Design	ZS-M Standard ZS-M-XL With long connecting thread
Temperature range	-60°C up to +200°C

Norm references:



Creator: M. Wegerer /PDP Released: DAMU1/PDP	Document: DB52104330EN Version: 04	Page 1 of 2
-------------------------------------------------	---------------------------------------	-------------

52104330	DATA SHEET	
Valid from: 12.06.2023	SKINDICHT® ZS-M / ZS-M-XL	

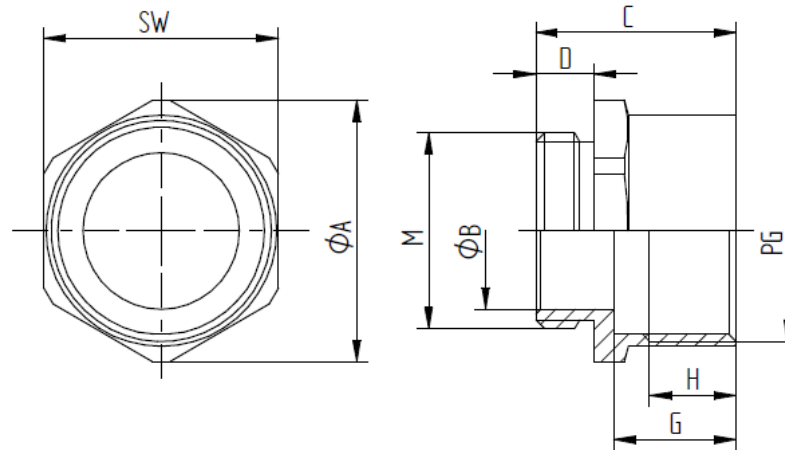

SKINDICHT® ZS-M

External thread M	Internal thread PG	Wrench Size SW mm	Diameter		Length C mm	Thread length D mm	Length G mm	Thread length H mm	Part No.
			Ø A mm	Ø B mm					
M12x1,5	PG 7	14	15,5	8	15	5	9	7	52104330
M16x1,5	PG 9	18	20	12	15,5	5	9,5	7	52104340
M16x1,5	PG 11	20	22,2	12	16	5	10	7	52104010
M20x1,5	PG 11	22	24	15	17	6	10	7	52104360
M20x1,5	PG 13,5	22	24	15	18,5	6	11,5	7,5	52104370
M20x1,5	PG 16	24	26,2	15	19,5	6	12,5	8	52104380
M25x1,5	PG 21	30	33	20	22	7	13,5	9	52104400
M32x1,5	PG 29	40	42,5	27	24,5	8	15	9,5	52104410
M40x1,5	PG 36	50	54	34	27,5	8	17,5	12	52104420
M50x1,5	PG 42	57	60	44	31	9	20	16	52104430
M63x1,5	PG 48	66	70	54	33	10	21	17	52104440

SKINDICHT® ZS-M-XL

External thread M	Internal thread PG	Wrench Size SW mm	Diameter		Length C mm	Thread length D mm	Length G mm	Thread length H mm	Part No.
			Ø A mm	Ø B mm					
M12x1,5	PG 7	14	15,5	8	20	10	9	7	52104335
M16x1,5	PG 9	18	20	12	20,5	10	9,5	7	52104345
M20x1,5	PG 11	22	24	15	21	10	10	7	52104365
M20x1,5	PG 13,5	22	24	15	22,5	10	11,5	7,5	52104375
M20x1,5	PG 16	24	26,2	15	23,5	10	12,5	8	52104385
M25x1,5	PG 21	30	33	20	26	11	13,5	9	52104405
M32x1,5	PG 29	40	42,5	27	29,5	13	15	9,5	52104415
M40x1,5	PG 36	50	54	34	32,5	13	17,5	12	52104425
M50x1,5	PG 42	57	60	44	36	14	20	16	52104435
M63x1,5	PG 48	66	70	54	37	14	21	17	52104445

For more information please see our current catalogue. Please do not hesitate to contact our laboratory if there are any questions regarding resistance against aggressive agents and special oil.

Creator: M. Wegerer /PDP Released: DAMU1/PDP	Document: DB52104330EN Version: 04	Page 2 of 2
-------------------------------------------------	---------------------------------------	-------------