

53112888	DATA SHEET	
Valid from: 24.01.2025	SKINTOP® CLICK BS	

The polyamide-based SKINTOP® CLICK BS with its snap-system and bending protection enables a very fast and easy assembly and the integral locking features guarantees permanent vibration resistance. It is designed for use, above all for particular functional safety in hand-held equipment, flexing machine parts, apparatus engineering, light and sound applications and robotics industry.



Components:

Gland body	Polyamide, V2 acc. to UL 94
Cap nut with protecting spiral	Polyamide, V2 acc. to UL 94
Sealing ring	Elastomer
Pressure nut	Polyamide, fibre-glass reinforced, V2 acc. to UL 94
Sealing flat washer (for sizes Ø 12, Ø 16, Ø 20, Ø 25)	Elastomer
O-ring (for size Ø 32)	NBR

Technical features:

Nominal sizes	Ø 12, Ø 16, Ø 20, Ø 25, Ø 32
Functional thread	Multi-start trapezoidal thread
Protection class	Sizes Ø 16, Ø 20, Ø 25, Ø 32: IP68 - 5 bar, test acc. to EN 60529 Size Ø 12: IP68 - 4 bar, test acc. to EN 60529
Temperature range	-20 °C up to +100 °C
Colour	RAL 7001 silver-grey RAL 7035 light-grey RAL 9005 black (UV-resistant in accordance to ISO 4892-2:2006, method A)

Approvals:



File Nr. E 79903
(Test in acc. to UL514B)

Norm references:



Creator: T. Dvoulety /PDP Released: DAMU1/PDP	Document: DB53112888EN Version: 09	Page 1 of 2
--	---------------------------------------	-------------

53112888	DATA SHEET	
Valid from: 24.01.2025	SKINTOP® CLICK BS	

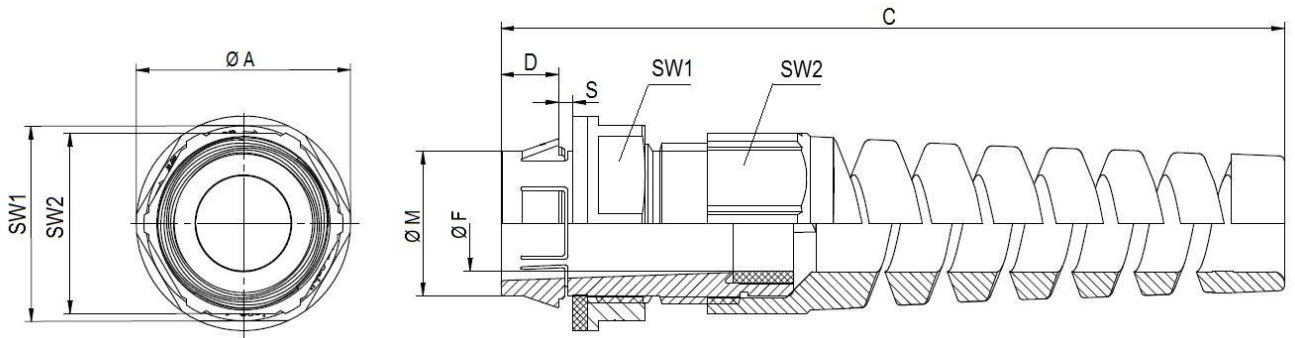

Size	Ø M [mm] Installation hole	SW1 / SW2 [mm]	Ø A [mm]	C [mm]	D [mm]	Ø F [mm] Clamping range	S [mm] Wall thickness	Article No.		
								RAL 7035	RAL 7001	RAL 9005
Ø 12	Ø 12,3 _{-0,2}	18 / 15	20,0	74	8	3,5-7	1-4	53112932	53112934	53112936
Ø 16	Ø 16,3 _{-0,2}	22 / 19	24,2	94	8	5-9	1-4	53112888	53112906	53112909
Ø 20	Ø 20,3 _{-0,2}	27 / 25	29,7	108	8	7-13	1-4	53112889	53112907	53112911
Ø 25	Ø 25,3 _{-0,2}	32 / 30	35,2	127	8	9-17	1-4	53112890	53112908	53112912
Ø 32	Ø 32,3 _{-0,2}	40 / 36	44,0	156	8	11-20	1-4	53112933	53112935	53112937

For more information please see our current catalogue. Please do not hesitate to contact our laboratory if there are any questions regarding resistance against aggressive agents and special oil.

Creator: T. Dvoulety /PDP Released: DAMU1/PDP	Document: DB53112888EN Version: 09	Page 2 of 2
--	---------------------------------------	-------------